

INSTALLATION GUIDE

Switch System

4 Person Workstation

Size: 1600x700 mm

www.jasonl.com.au

Need help!

Call us on
1300 527 665

jason.l
your office furniture mate

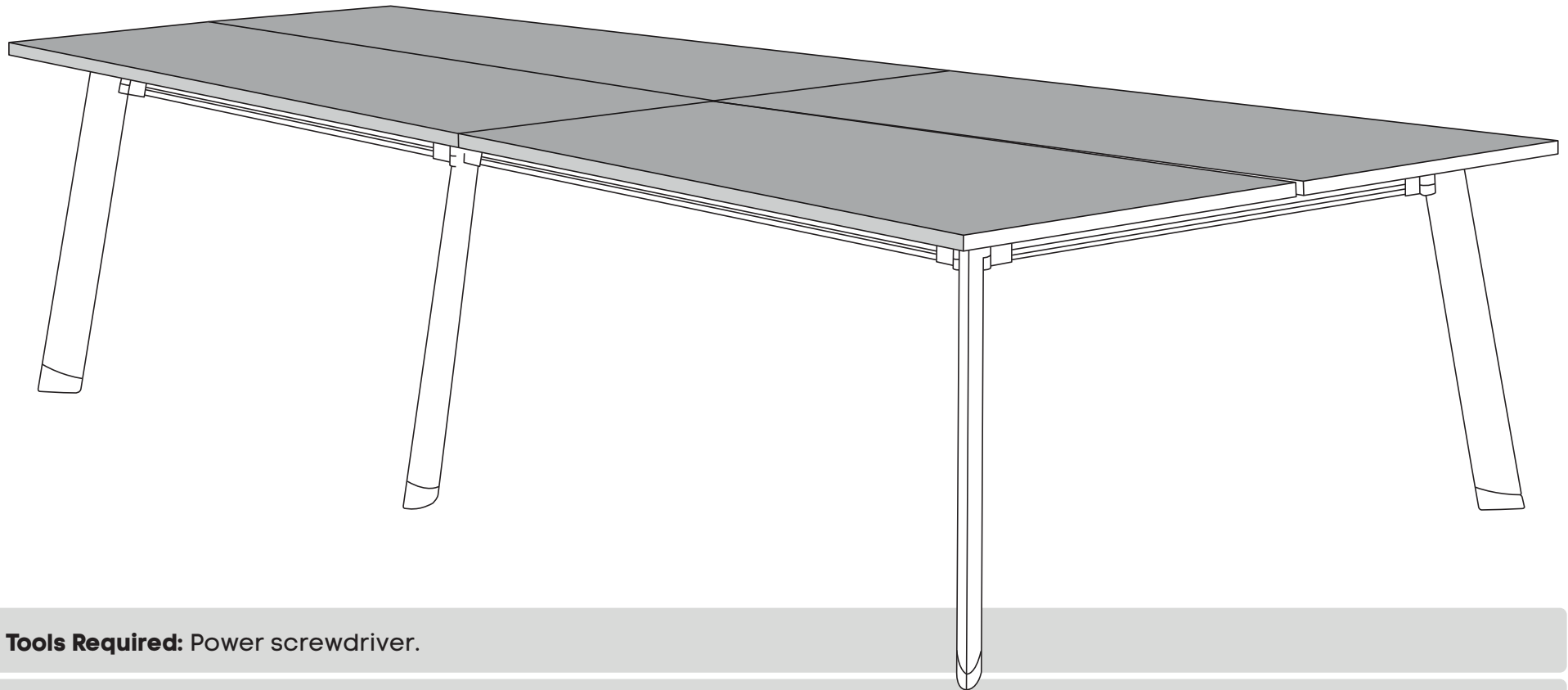

Tools Required: Power screwdriver.

Note: Please ignore any pre-drilled holes or nut inserts that maybe present in your top(s). They will not match your particular table/desk base and woods screws will be required to be screwed directly into the underside of the top.

Note: It is important to fully tighten all bolts and screws before attaching the top(s) so that the frame is sufficiently rigid. Failure to do this may affect stability once the tops are attached.

INSTALLATION GUIDE

Switch System

4 Person Workstation

www.jasonl.com.au

Need help!

Call us on
1300 527 665

jason.l
your office furniture mate



Size: 1600x700 mm

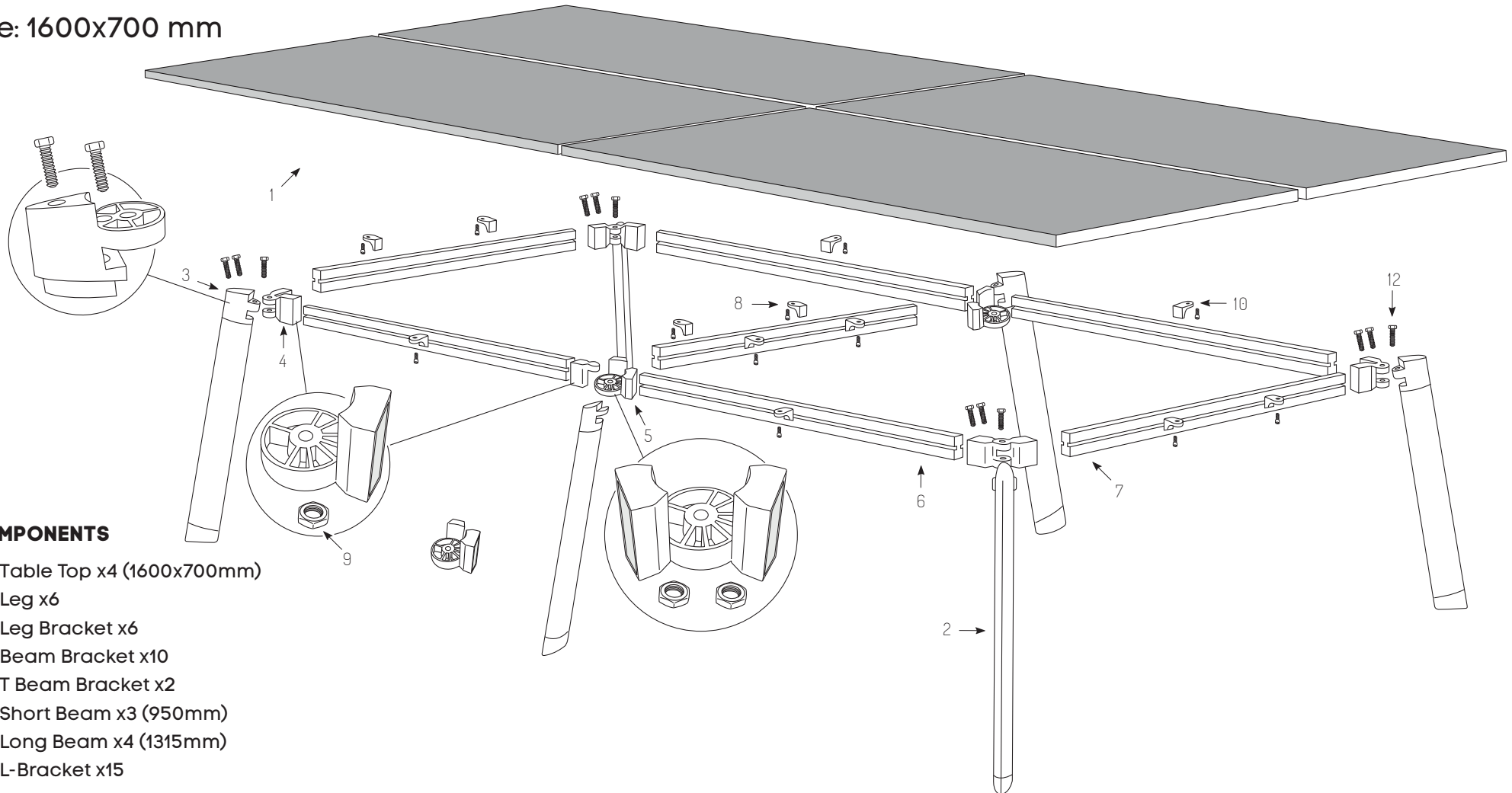

COMPONENTS

- 1 Table Top x4 (1600x700mm)
- 2 Leg x6
- 3 Leg Bracket x6
- 4 Beam Bracket x10
- 5 T Beam Bracket x2
- 6 Short Beam x3 (950mm)
- 7 Long Beam x4 (1315mm)
- 8 L-Bracket x15

SCREWS

- 9 Hex Nut x6
- 10 L-Bracket screws x15
- 11 Hex Head screws x26
- 12 M8x25mm Dome Head x6

INSTALLATION GUIDE

Switch System

4 Person Workstation

www.jasonl.com.au
Need help!
Call us on
1300 527 665

jason.l
your office furniture mate



Size: 1600x700 mm

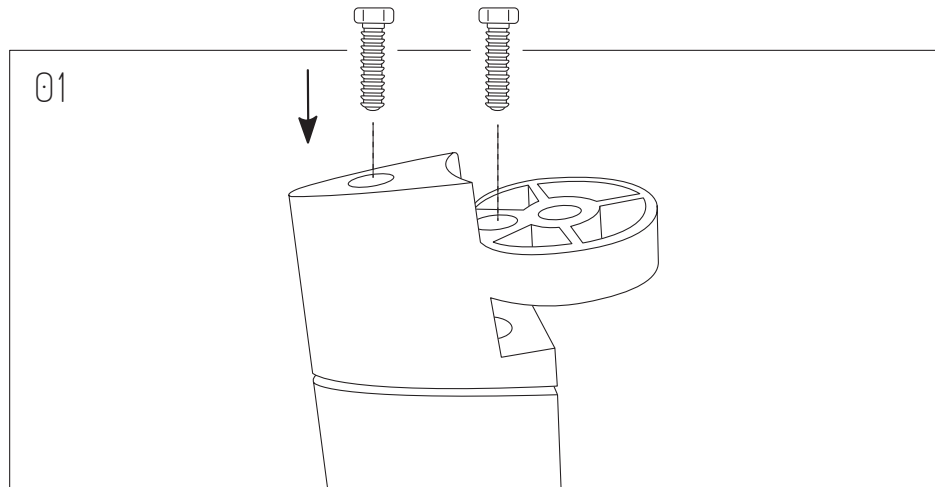

Join Leg Brackets to each Leg using screws to secure them, as follow.

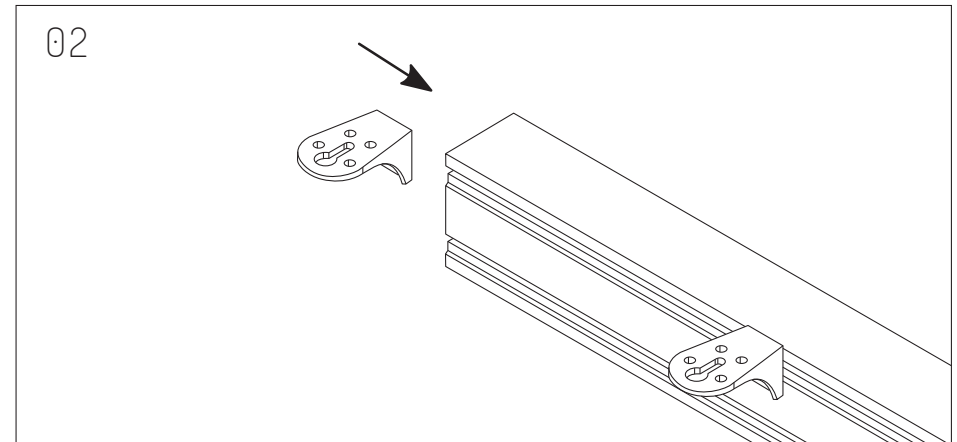

Join 2 L-Bracket through each 1315mm Beam and 1 L-Bracket through each 950mm Beam.

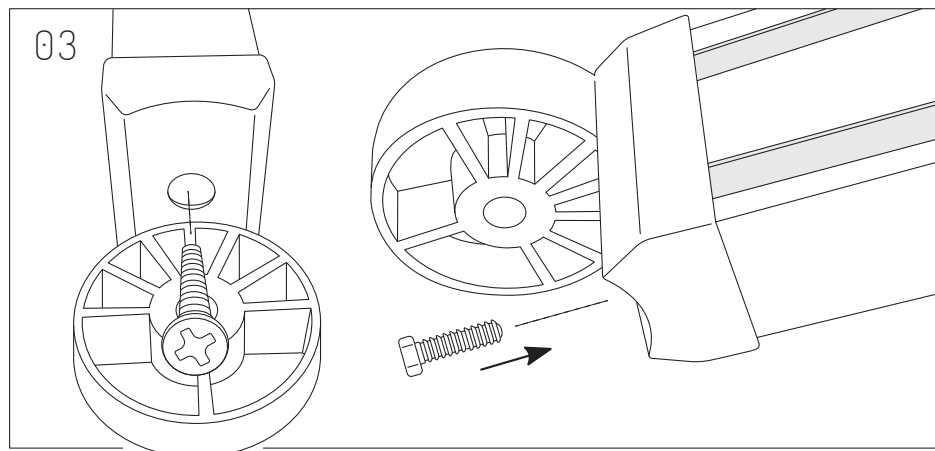

Securely connect each Beam to each Beam Bracket. Screw to secure.

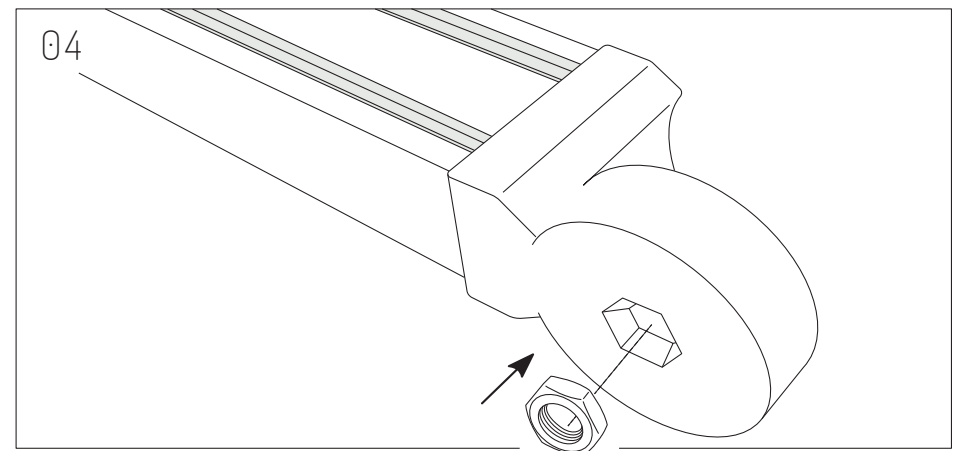

Insert Hex Nut on each Beam Bracket.

INSTALLATION GUIDE

Switch System

4 Person Workstation

Size: 1600x700 mm

www.jasonl.com.au

Need help!

Call us on
1300 527 665

jason.l
your office furniture mate

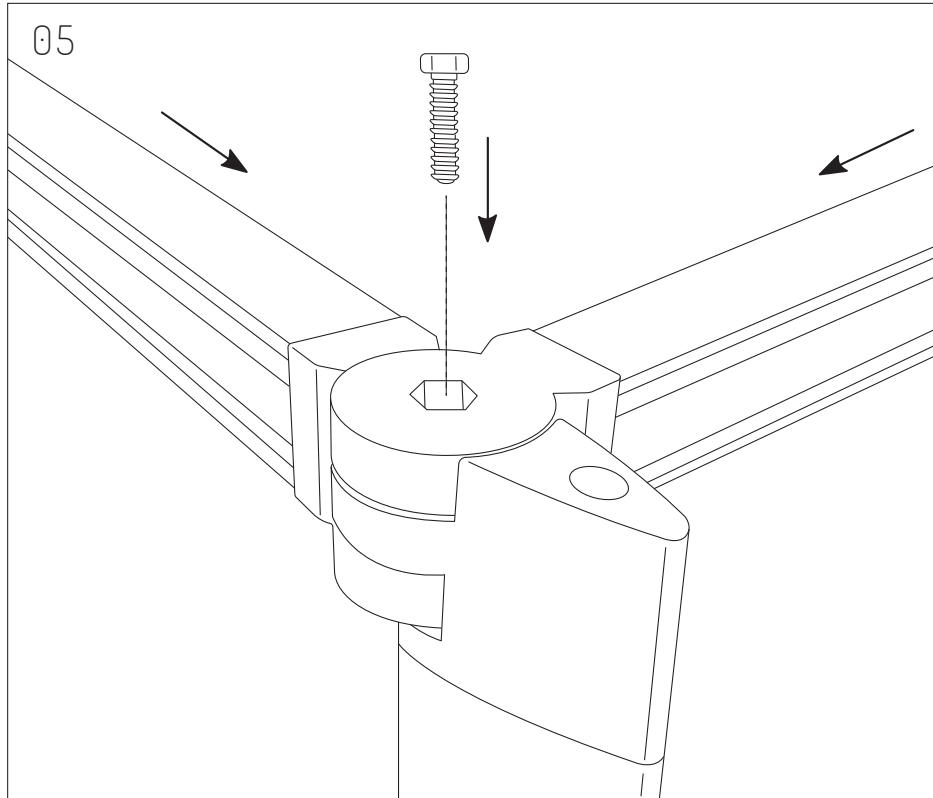

Position as presented, and proceed to screw to ensure each corner of the frame.

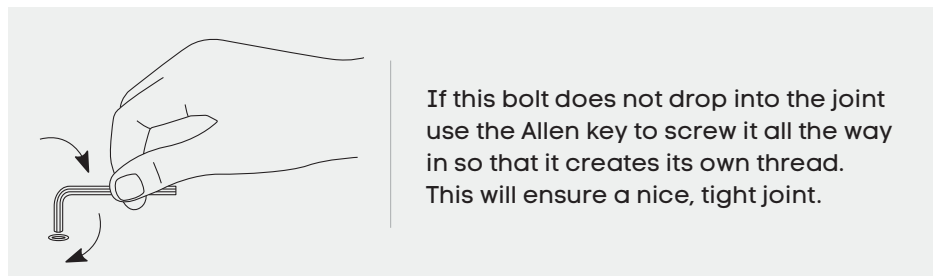

If this bolt does not drop into the joint use the Allen key to screw it all the way in so that it creates its own thread. This will ensure a nice, tight joint.

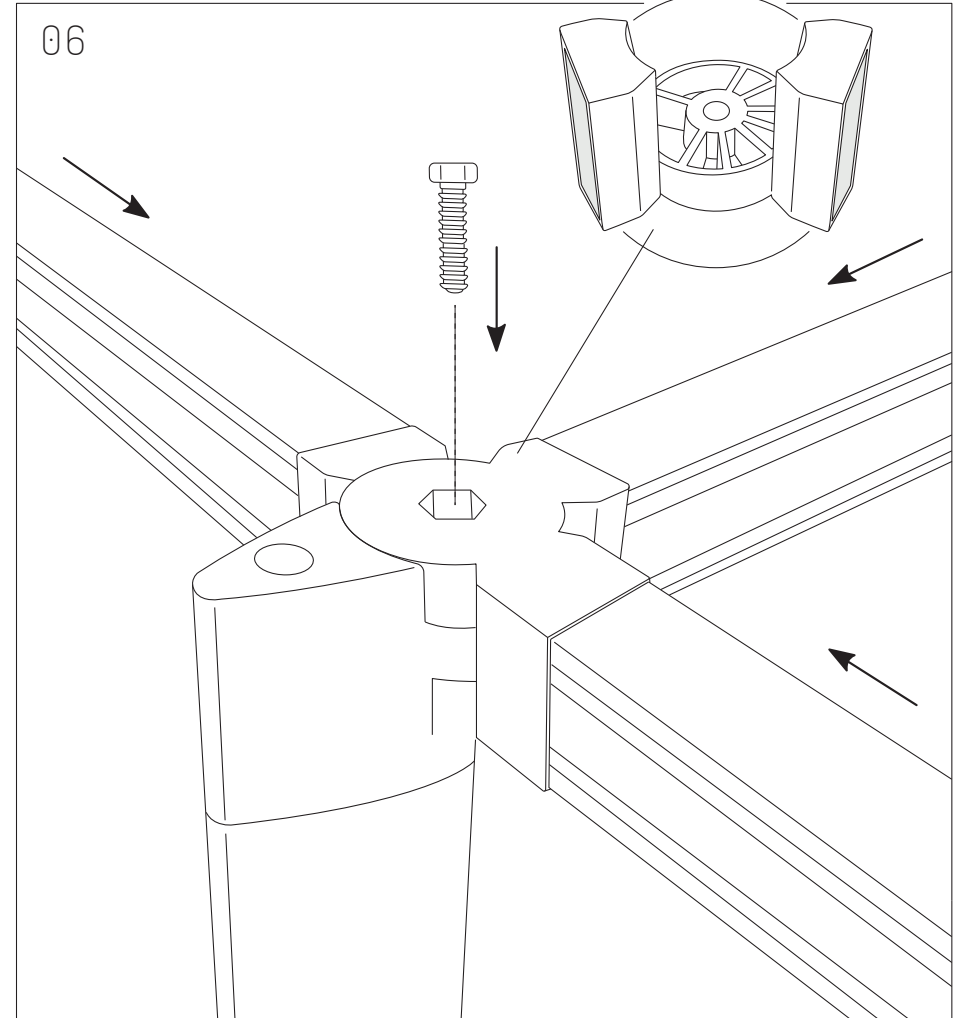

For the 2 central legs, attach as presented, using T Beam Bracket.

INSTALLATION GUIDE

Switch System

4 Person Workstation

www.jasonl.com.au

Need help!

Call us on
1300 527 665

jason.l
your office furniture mate



Size: 1600x700 mm

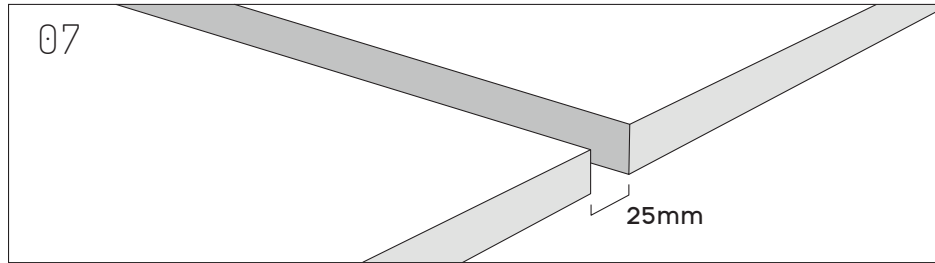

Once we get the whole frame ready, ensure the worksurface is centered over the frame. If you are planning to install a divider screen, leave a 25mm gap between tables.

Note: If you are planning to install Pincer Brackets like the image to the right, you need to attach these brackets before continuing.

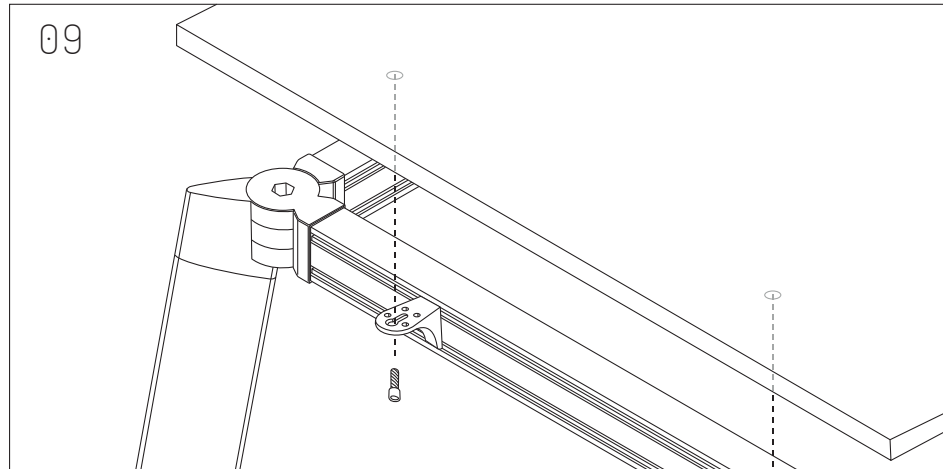
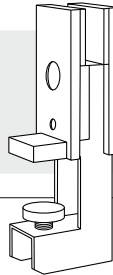

Once we get the whole frame ready, ensure the worksurface is centered over the frame. and fully tighten all M6x40mm Hex Head to Table Tops, through each L-Bracket.

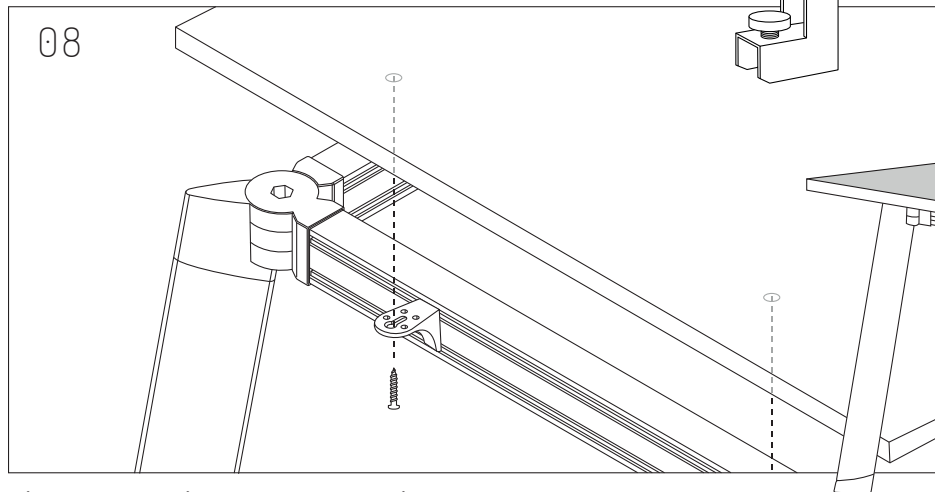

Directly screw into table tops, using L-Bracket screws through each L-Bracket.

Note: It is important to fully tighten all bolts and screws before attaching the top(s) so that the frame is sufficiently rigid. Failure to do this may affect stability once the tops are attached.

