

ASSEMBLY INSTRUCTIONS

Elements Workstation 2 Person Run

Size: 1600mm

www.jasonl.com.au

Need help!

Call us on
1300 527 665

jason.l
your office furniture mate

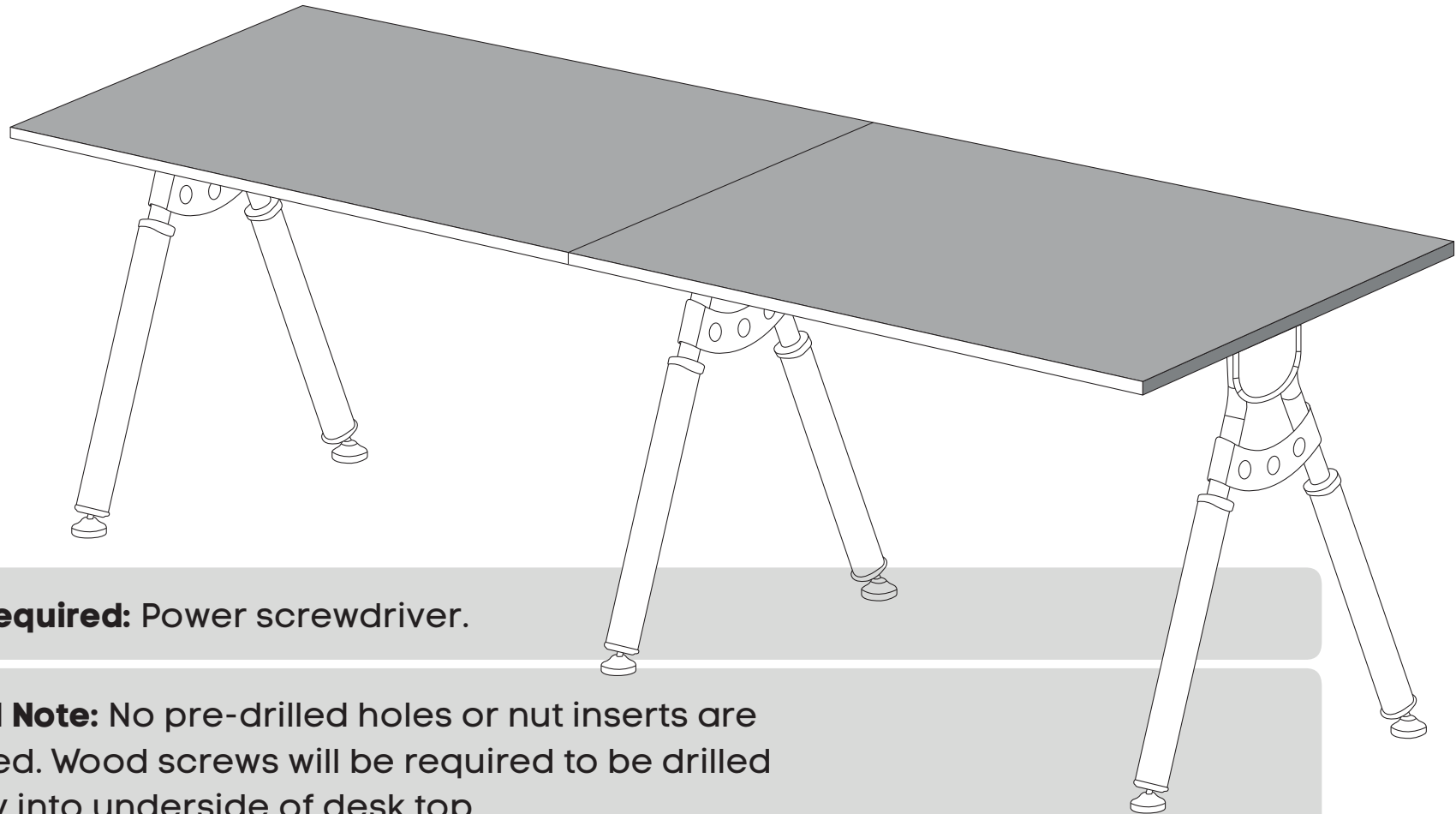

Tools Required: Power screwdriver.

Special Note: No pre-drilled holes or nut inserts are provided. Wood screws will be required to be drilled directly into underside of desk top.

 2 persons required for installation

ASSEMBLY INSTRUCTIONS

Elements Workstation 2 Person Run

Size: 1600mm

www.jasonl.com.au

Need help!

Call us on
1300 527 665

jason.l
your office furniture mate

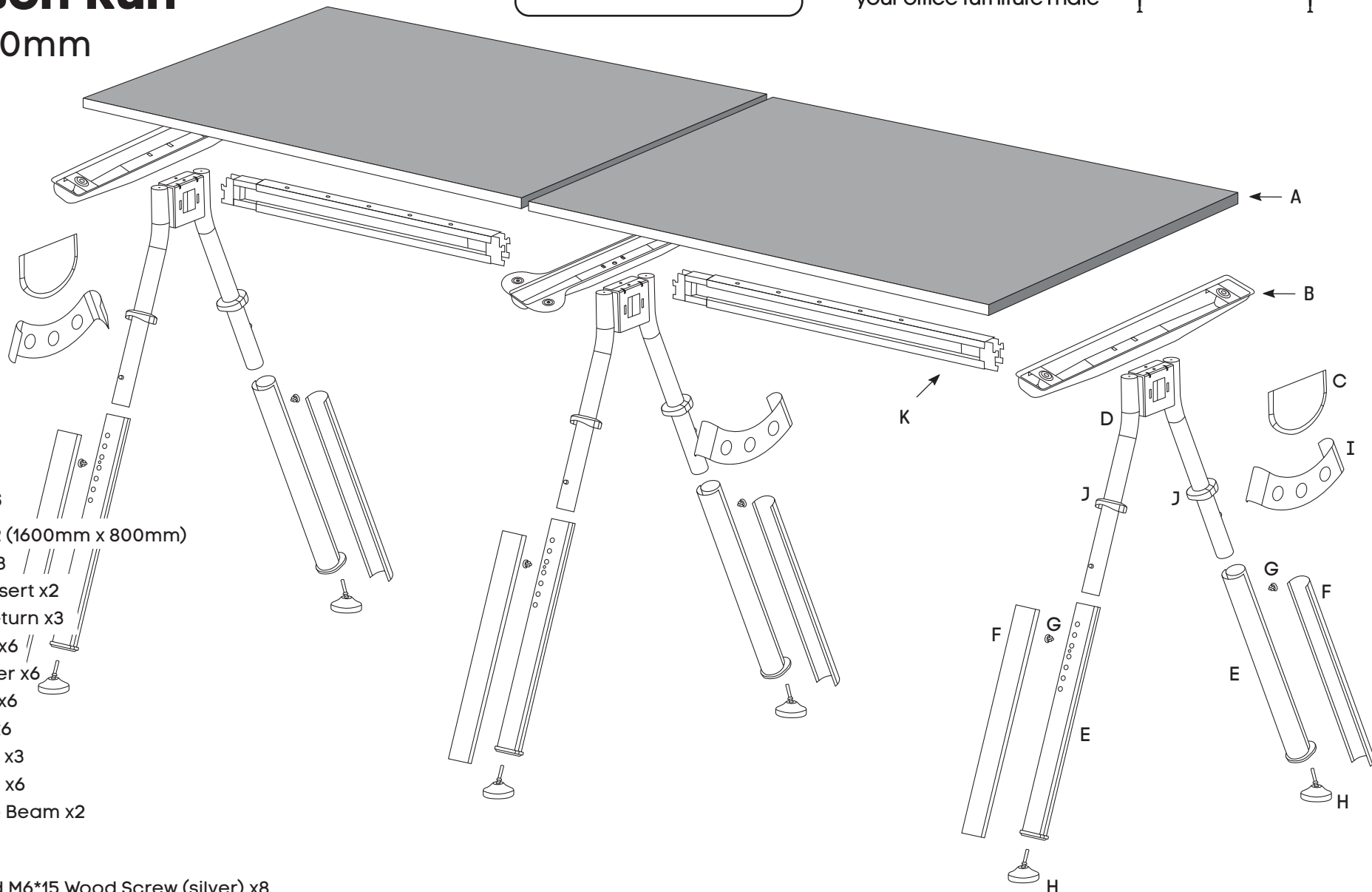

COMPONENTS

- A Desk top x2 (1600mm x 800mm)
- B Top plate x3
- C Leg core insert x2
- D Leg core return x3
- E Leg sleeve x6
- F Sleeve cover x6
- G Fold Screen x6
- H Base Foot x6
- I Core cover x3
- J Sleeve Cap x6
- K Extendable Beam x2

SCREWS

- L Phillip Head M6*15 Wood Screw (silver) x8
- M Phillip Flat Head M6*20 Screw (gold) x12

ASSEMBLY INSTRUCTIONS

Elements Workstation 2 Person Run

Size: 1600mm

www.jasonl.com.au

Need help!

Call us on
1300 527 665

jason.l
your office furniture mate



01

- Unwrap all leg components.
- Remove sleeve cap (J) and sleeve cover (F) from all leg sleeves.
- Insert base foot (H) into leg sleeve (E) by rotating base foot (H) clockwise.
- Insert sleeve cap (J) onto leg core (D) for all legs.
- Insert leg sleeve (E) onto leg core (D) for all legs. TIP: Keep height adjustment holes pointing outwards.
- Place leg core insert (C) onto leg core (D) for all legs.
- Place core cover (I) onto leg core (D) for all legs.
- Place sleeve cover (F) over leg sleeve (E) for all legs.

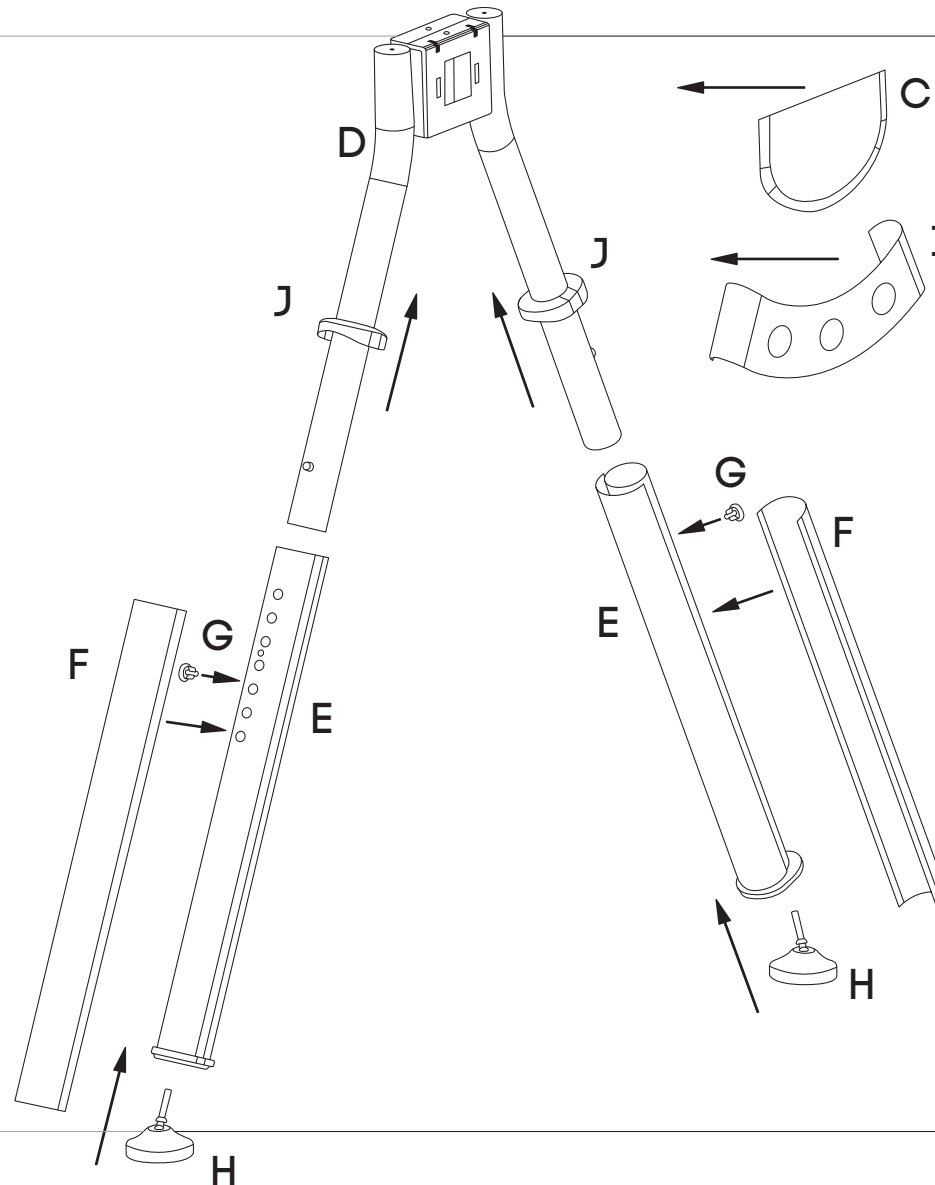

ASSEMBLY INSTRUCTIONS

Elements Workstation 2 Person Run

Size: 1600mm

www.jasonl.com.au

Need help!

Call us on
1300 527 665

jason.l
your office furniture mate

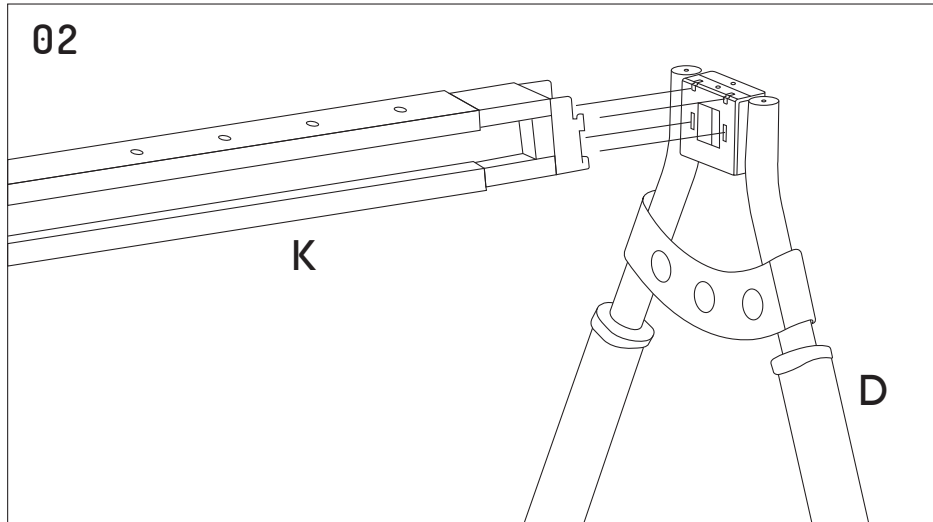

Connect extendable Beam (K) to Leg Core (D)

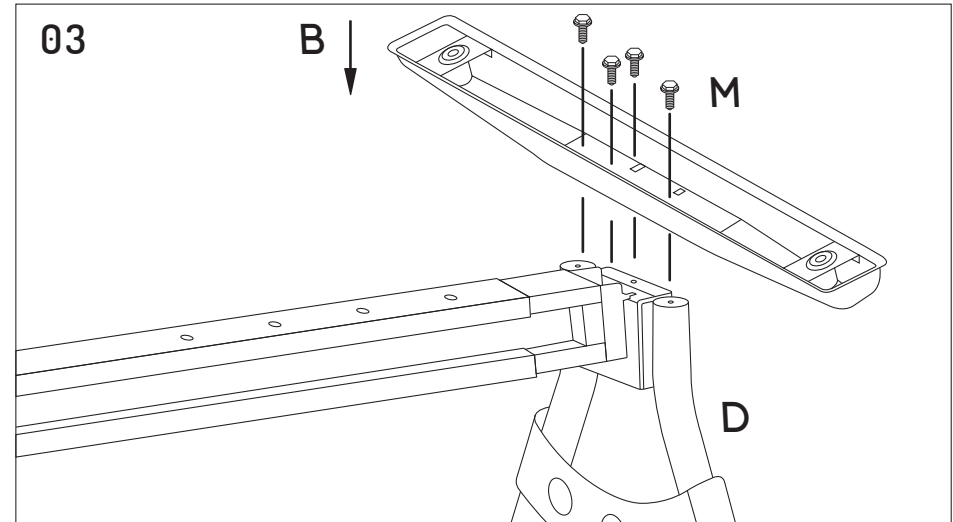

Tighten Top Plates (B) to outer legs core (D) by tightening Screw (M).

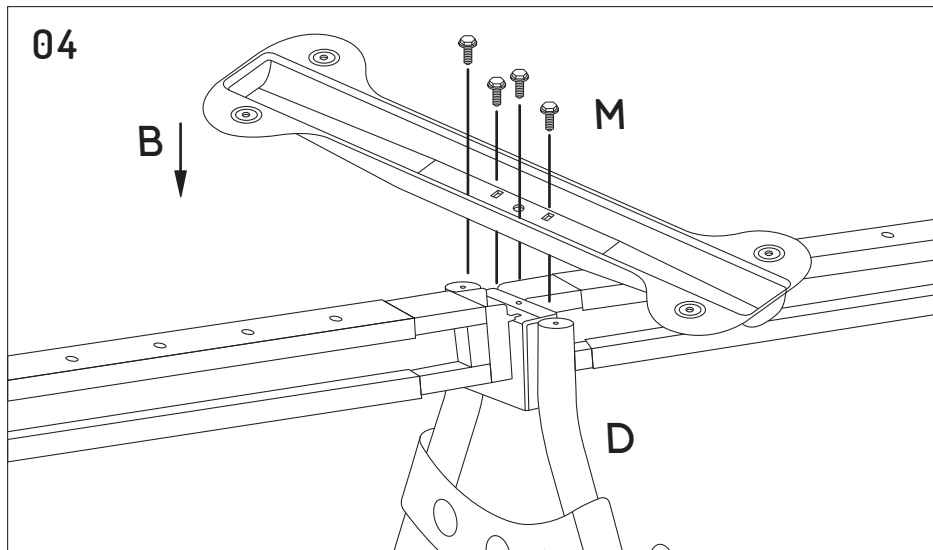

Tighten Top Plate (B) to middle leg core (D) by tightening Screw (M).

ASSEMBLY INSTRUCTIONS

Elements Workstation 2 Person Run

Size: 1600mm

www.jasonl.com.au

Need help!

Call us on
1300 527 665

jason.l
your office furniture mate

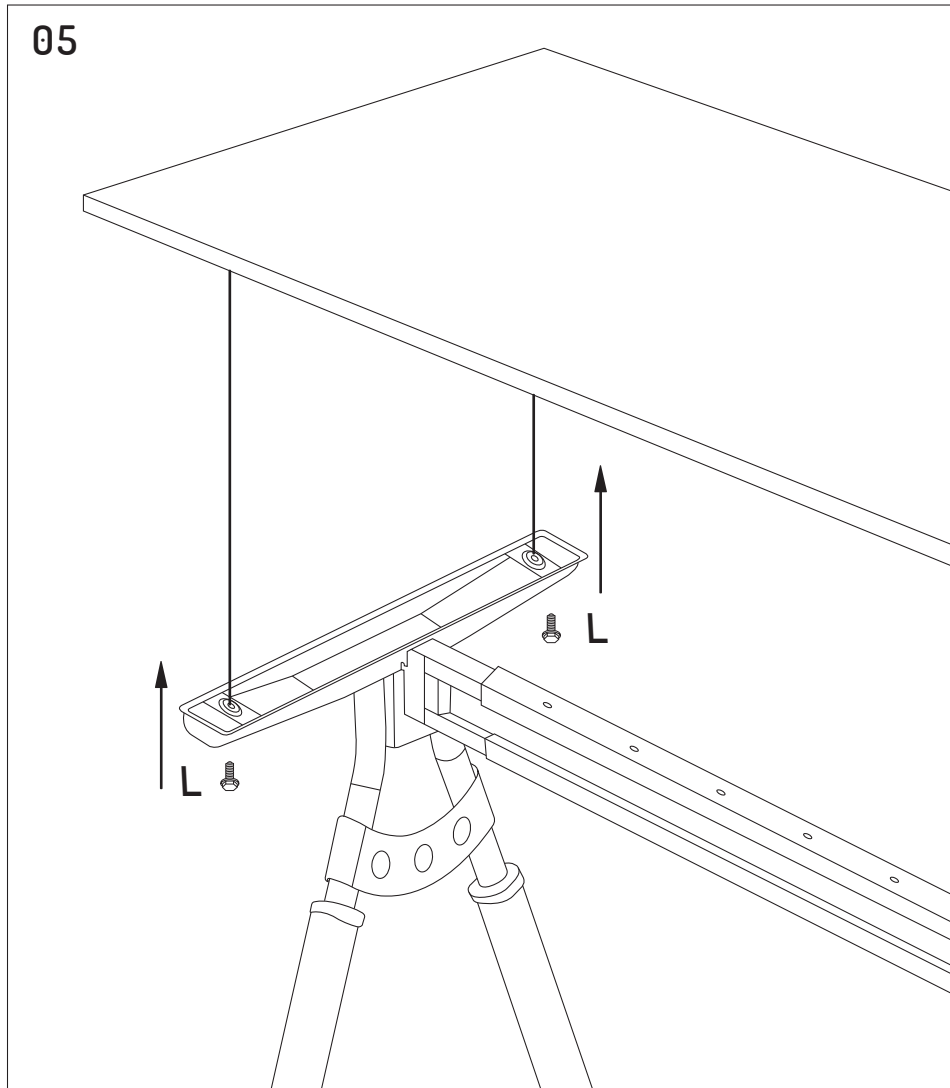

Attach outsider legs + beam to Desk Tops by tightening Scews (L).

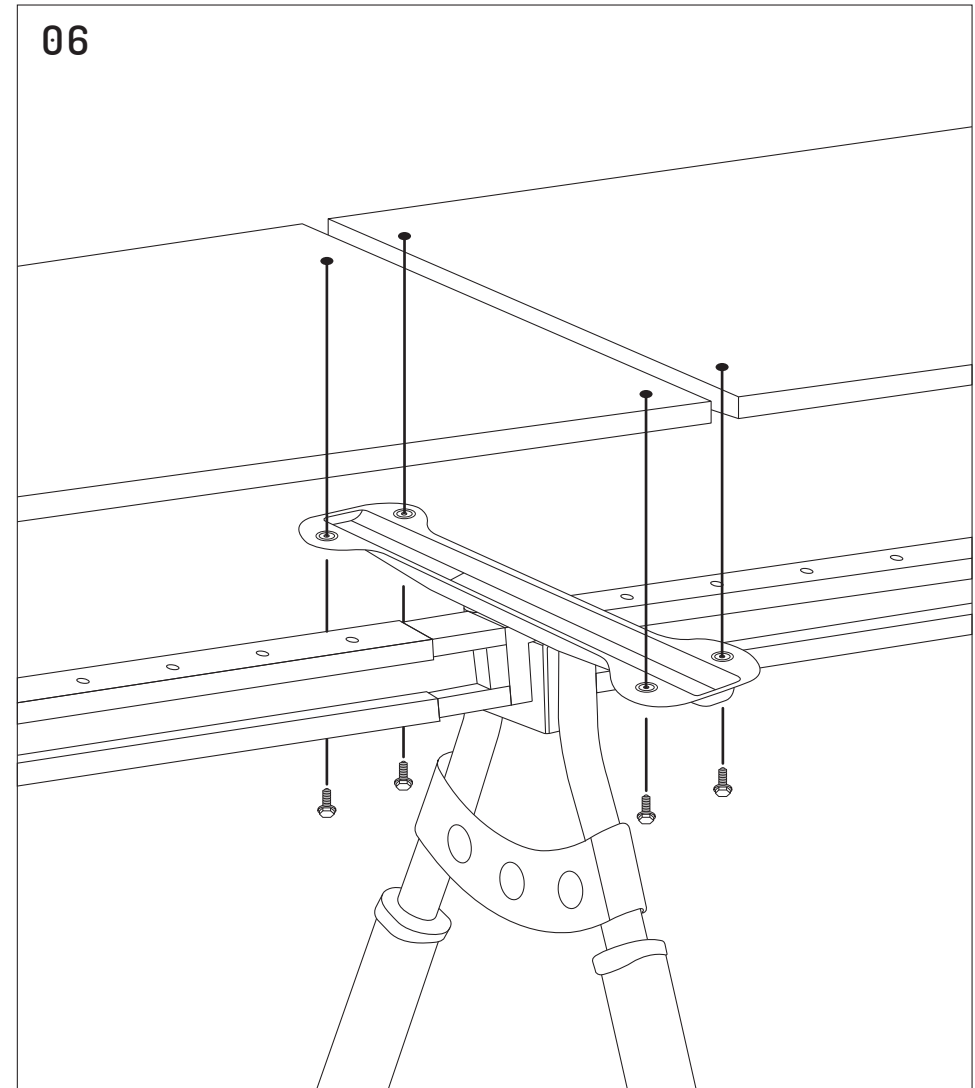

Attach middle leg to Desk Tops by tightening Scews (L).