



98%

MADE IN THE USA



CARS/TRUCKS

BOATS

HELICOPTERS



AIRPLANES

DU-BRO[®]

WE DON'T MAKE THE MODELS..WE MAKE THEM BETTER

OVER
60
YEARS
WWW.DUBRO.COM

AILERON CONTROL	26-27	GLO-PLUG IGNITOR	60
AXLES	39	HINGES	9, 12
BALL LINKS	29-30, 63	KWIK LINKS	21-22
BOAT ACCESSORIES	27	LANDING GEAR & ACC.	35-39
BODY ACCESSORIES	8, 62	MOTOR MOUNTS	49
BODY KLIPS	62	NOSE GEAR	37-39
BOLTS	31-34	NUTS	32
BUILDING SUPPLIES	9-12	PRESSURE FITTINGS	50
CAR/TRUCK ACCESSORIES	8, 60-63	PROP BALANCER	6
CLEVIS	21-22	PROP NUTS	47
COLLARS	38-41	PULL-PULL SYSTEMS	14, 27-28
CONTROL HORNS	17-20	PUSH RODS	25-26
COUPLERS	24	RADIO ACCESSORIES	9, 13-16
E/Z CONNECTORS	15-16	SCREWS	31-34
E/Z LINKS	22	SERVO ARMS	13-16
ENGINE ACCESSORIES	49-51	SERVO SAVER	24
EXHAUST DEFLECTORS	51	SNOW SKIS	35-36
FASTENERS	31-34	SPINNERS	48
FLEX CABLES	26-27	SWITCH MOUNTS	13
FOAM	10	TAILWHEELS	37-40, 46
FUEL ACCESSORIES	52-59	TAPE	10, 12
FUEL CAP FITTINGS	52, 55	TIRES/WHEELS	40-46
FUEL FILTERS	55	TOOLS	3-8
FUEL PUMPS	59	T-PINS	10
FUEL TANKS	57	TURNBUCKLES	24, 61
FUEL TUBING	52	WASHERS	33
FUELING VALVES	53-54	WEBSITE	WWW.DUBRO.COM

NEW

KWIK SAND HAND SANDER

- Use Self-Adhesive Sandpaper
- Lightweight Aluminum
- 5.5" - 11" - 22" Available
- Many Uses In Hobby & Home
- Pre-Cut Sandpaper Available
- **MADE IN USA**

5.5"**11"****22"****KWIK SAND
HAND SANDER**WWW.DUBRO.COM**DU-BRO**

KWIK SAND HAND SANDER

These aluminum sanding bars are lightweight and durable. Their contoured handle provides a secure, comfortable grip.

They are designed to use pre-cut, self-adhesive sandpaper that is easy to apply. Each Kwik Sand hand sander includes a 3-pack of sandpaper with (1) 80, (1) 150, and (1) 220 grit piece. Because the sandpaper is already the perfect size, you just peel, stick and start sanding!

No. 3400-55	5.5" Kwik Sand Hand Sander
No. 3400-11	11" Kwik Sand Hand Sander
No. 3400-22	22" Kwik Sand Hand Sander
No. 3405-80	5.5" Premium Sandpaper- 80 Grit (QTY/PKG: 6)
No. 3405-150	5.5" Premium Sandpaper- 150 Grit (QTY/PKG: 6)
No. 3405-220	5.5" Premium Sandpaper- 220 Grit (QTY/PKG: 6)
No. 3406-80	11" Premium Sandpaper- 80 Grit (QTY/PKG: 6)
No. 3406-150	11" Premium Sandpaper- 150 Grit (QTY/PKG: 6)
No. 3406-220	11" Premium Sandpaper- 220 Grit (QTY/PKG: 6)
No. 3407-80	22" Premium Sandpaper- 80 Grit (QTY/PKG: 6)
No. 3407-150	22" Premium Sandpaper- 150 Grit (QTY/PKG: 6)
No. 3407-220	22" Premium Sandpaper- 220 Grit (QTY/PKG: 6)



**VIDEO DEMO
ON-LINE**



**Centering/Parallel Guide Fits
Up to 3/4" Thick Trailing Edges**

HINGE SLOTTER KIT

Du-Bro hinge slotter takes the hassle out of slotting control surfaces for gluing hinges. The centering/parallel guide, centers hinge slotter on up to 3/4" (19.0mm) material. Four handle set plus guide and centering tool for three different size slotting forks: min, standard and heavy duty hinges. Designed to work with all Du-Bro hinges. The 3 slotters and the "picker" are permanently mounted to red nylon handles. Packaged in reusable, recyclable clamshell storage blister.

1 set/pkg. **No. 660**

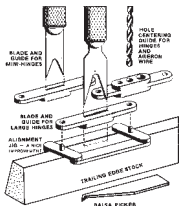

KWIK-HINGE SLOTTER

Centers & guides for perfectly aligned slots for any hinge. 3 blades fit No. 2 X-Acto® handle. 3 snap-on jig guides. 1/pkg. **No. 216**

E/Z THREADER

The 3-in-1 installation tool. This economical tool is a must for every modeler! It makes installing swivel ball links, nylon kwik links and cup style ball links simple and easy. Buy one for your workbench & one for your field box. Designed and Made in the U.S.A. **No. 725**



Thread Ball Links



**VIDEO DEMO
ON-LINE**



*Thread Nylon
Kwik-Links*



TUBING BENDERS

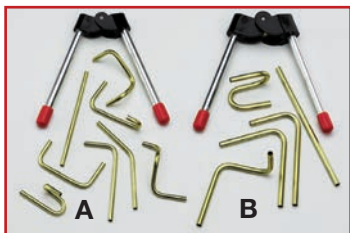

Designed for use with 1/8" or 5/32" brass fuel tubing or aluminum tubing. Does not collapse tubing wall. Perfect for use on air lines for re-tracts. Bends annealed brass or aluminum tubing. Includes annealed tubing. NOTE: Will not bend hard brass or aluminum tubing.

No. 785(A) 1/8" Tubing Bender

(Bend tubing down to 1/16" dia.)

No. 786(B) 5/32" Tubing Bender

**VIDEO DEMO
ON-LINE**

E/Z BENDER WIRE FORMING TOOL

Z-Bends made with (2) pin side.

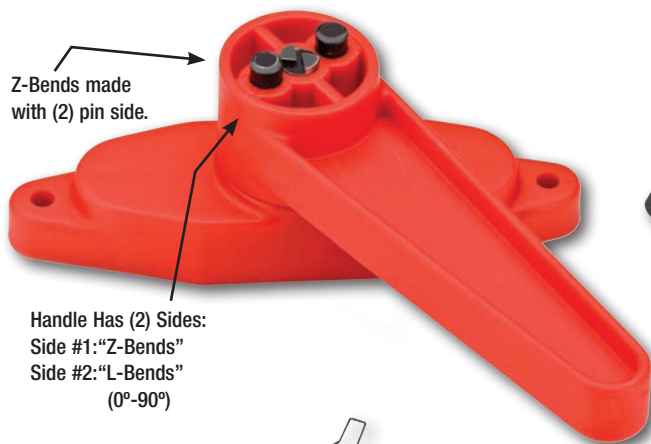

Handle Has (2) Sides:
Side #1: "Z-Bends"
Side #2: "L-Bends"
(0°-90°)



Units include:
(2) Forming Dies

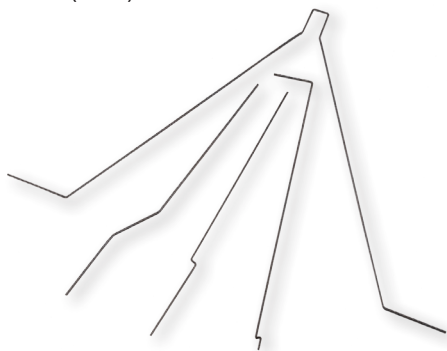

Make Custom Landing Gear,
Z-Bends, L-Bends & More!



Mount to Bench or
in your Vise

VIDEO DEMO
ON-LINE

A commercial quality wire bender, built specifically for the hobby industry, which bends wires from 0° to 90° and makes perfect Z-bends, L-bends, landing gear and more.

With one movement, the E/Z Bender will form wires to your exact specifications. The E/Z Bender features hardened steel forming dies for long lasting operation. It's design was made to be a perfect addition to the modelers workshop or it can be easily mounted to your workbench. It also fits perfectly in your bench vise.

No. 480 E/Z Bender Wire Forming Tool (Wire Range: .015" - .047" / 0.38mm - 1.20mm)

No. 481 E/Z Bender Wire Forming Tool (Wire Range: .062" - .093" / 1.45mm - 2.40mm)

NOTE: The #480 can be used with music/hardened wire in the corresponding wire size range. However, #481 can only support music/hardened wire up to .062" wire. All larger wire must not be music/hardened. This also applies to the individual dies sold separately below.

No. 483 E/Z Bender Wire Forming **Die Only** (Wire Range: .015" - .020" / 0.38mm - 0.52mm)

No. 484 E/Z Bender Wire Forming **Die Only** (Wire Range: .031" - .047" / 0.80mm - 1.20mm)

No. 485 E/Z Bender Wire Forming **Die Only** (Wire Range: .062" - .072" / 1.58mm - 1.83mm)

No. 486 E/Z Bender Wire Forming **Die Only** (Wire Range: .072" - .093" / 1.83mm - 2.37mm)

TRU-SPIN PROP BALANCER

Du-Bro's Tru-Spin Prop Balancer is the most precise balancer on the market. Our specially designed locking cone securely centers and locks props on to the balancing shaft for the utmost accuracy. Each cone is carefully inspected on a calibrator to make sure it is running true. The balancing shaft is manufactured out of hardened material and then is centerless ground, giving precision balance every time. The prop balancer's aluminum wheels turn virtually friction free for precision accuracy. The Du-Bro Tru-Spin Prop Balancer will balance model airplane props of all sizes & weights, boat props, spinners, car wheels, helicopter rotor heads, jet fans, fly wheels, etc. Each balancer comes complete with easy to follow assembly and prop balancing instructions. A truly precision instrument built for the modeler who expects the very best. 1/pkg. No. 499 *Max diameter for prop hole = 19/32" / 0.5938" / 15.0mm



VIDEO DEMO
ON-LINE



No. 959 Replacement Prop Balancer Shaft 1/pkg.
5.50" Long

No. 978 XL Prop Balancer Shaft 1/pkg.
8.00" Long

Balance Props from Foamy up to Giant Scale & Drones

A MUST FOR MAKING
ROCK SOLID,
STABLE VIDEO



DRONE/QUADCOPTER BALANCER

The DU-BRO Drone/Quadcopter prop balancer's aluminum wheels turn virtually friction free for precision accuracy. The Du-Bro Tru-Spin Prop Balancer will balance drone props of all sizes and weights. *See website for which balancing shaft is required for your drone.*

#3396, 3380, 3381, 3383, 3384 - Specially designed balancing shaft with left and right hand threads. Balancing shaft is made of CNC machined aircraft aluminum for a precision balance.

Some very popular drone models such as the DJI Phantom 4 include unique prop hub that will not work with traditional balancers. DU-BRO has a solution for these props with our centerless ground Friction-Fit prop balancing shafts that works with the popular #499 or #3396 Tru-Spin Prop Balancer. Look for shafts: #3387 & #3388.

STANDARD & METRIC BALL WRENCHES

The perfect tool for getting at those hard-to-reach places. Ball wrenches make it possible to turn socket head screws or bolts from any angle. Available in many sizes. 1/pkg.

No. 442 5/64" (2-56 Skt. Hd.)

No. 886 1/16" (#4 Button Hd.)

No. 443 3/32" (4-40 Skt. Hd.)

No. 444 7/64" (6-32 Skt. Hd.)

No. 445 9/64" (8-32 Skt. Hd.)

No. 446 5/32" (10-32 Skt. Hd.)

No. 447 5 pc. Standard Set (5/64", 3/32", 7/64", 9/64", 5/32")

No. 507 .050 Ball Wrench

No. 705 Deluxe 6 pc. Standard Set w/holder

(.050, 5/64", 3/32", 7/64", 9/64", 5/32")

Metric Ball Wrenches 1/pkg.

No. 448 1.5MM (2.0MM Skt. Hd.)

No. 449 2.0MM (2.5MM Skt. Hd.)

No. 450 2.5MM (3.0MM Skt. Hd.)

No. 451 3.0MM (4.0MM Skt. Hd.)

No. 452 4.0MM (5.0MM Skt. Hd.)

No. 453 5 pc. Metric Set

No. 706 Deluxe 5 pc. Metric Set w/holder

**VIDEO DEMO
ON-LINE**



*Reaches Socket Head
Bolts up to a 30° Angle.*



4-WAY SOCKET WRENCH

Our 4-Way Socket Wrench offers modelers a quality socket wrench at an affordable price. Available in two sizes (standard and XL) our wrench will accommodate both American and Metric sizes (5/16", 3/8", 7/16", 1/2", 8mm, 10mm, 11mm, 12mm). Also features 3 built-in glo-plug holders and special retaining clip. **Storage Klip** - Mounts securely to field box keeping 4-way wrench readily accessible. (Storage Klip and mounting screws come complete with 4-Way Wrench). 1/pkg.

No. 701 4-Way Socket Wrench

No. 702 4-Way Socket Wrench XL

*Special glo-plug
retaining clip securely
holds glo-plug for
easy installation and
removal.*



**VIDEO DEMO
ON-LINE**

1-1/4" (32MM) CUT OFF WHEELS

Perfect for cutting through most woods, plastics and metals. Designed with fiberglass reinforcement to prevent brittleness. 2/pkg.

No. 352

No. 353 Cut Off Wheel w/ Mandril (1 set/pkg.)



**VIDEO DEMO
ON-LINE**

THREADED STUD DRIVER

This unique tool takes the hassle out of threaded studs and threading threaded rods into plastic push rods (such as Du-Bro Lazer Rods and other push rods on the market). To use, simply thread your stud or rod into either the 4-40 or 2-56 end of the driver until it bottoms out, then thread rod/stud into plastic push rod until desired length is reached and finally back off driver. It's fast and easy! No more damaging threads with pliers. 1/pkg. No. 504



T-STYLE TAP HANDLE

The collet on Du-Bro's T-Style Tap Handle will securely hold the tap while tapping. Will accommodate 2-56 to 1/4" taps. 1/pkg.

No. 633

TAP & DRILL SETS

These high quality steel tap & drill sets are available in 6 popular sizes: 2-56, 4-40, 6-32, 8-32,

10-32 & 1/4-20. 1 set/pkg.

Metric

No. 370 2.0MM

No. 371 2.5MM

No. 372 3.0MM

Metric (cont.)

No. 373 4.0MM

No. 374 5.0MM

No. 360 2-56	No. 363 8-32
No. 361 4-40	No. 359 10-32
No. 362 6-32	No. 364 1/4-20

FULL SET STANDARD/METRIC TAP & DRILLS

10 piece standard tap & drill set comes complete with 2-56, 4-40, 6-32, 8-32 and 10-32 tap & drill sets. 1/pkg. No. 509

10 piece metric tap and drill set comes complete with 2MM, 2.5MM, 3.0MM, 4.0MM and 5.0MM tap and drill sets. 1/pkg. No. 510



KWIK TWIST

Enables you to tie perfect barrel wraps to each end of music wire to make beautiful guy wires, using piano wire up to .032 (0.8mm) dia. 1/pkg. No. 301

VIDEO DEMO
ON-LINE

SCISSORS & REAMER SET

Two essential tools for the shop are the Body Reamer & Scissors. Whether you are reaming holes for your body posts, antenna, or cutting a custom shape, you need quality equipment.

No. 2330 Body Reamer & Scissors Set (Curved)
1 ea./pkg.

No. 2331 Body Reamer, Scissors (Straight)
& Scissors (Curved) Set
1 ea./pkg.

Curved



Straight



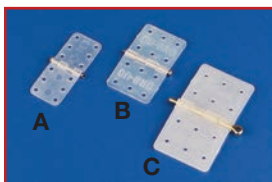

NYLON HINGES

Precision molded, inspected and assembled with locked in hinge pin. Flash free, simple to install. Hinges have 6 holes on each side for maximum holding power.

No. 118 (A) Mini 7/16" (11mm) W x 1-1/8" (28mm) L. 6/pkg.

No. 119 (A) Mini 7/16" (11mm) W x 1-1/8" (28mm) L. 15/pkg.

No. 116 (B) Std. 5/8" (16mm)W x 1-1/8" (28mm)L. 6/pkg.

No. 117 (B) Std. 5/8" (16mm)W x 1-1/8" (28mm) L. 15/pkg.

HEAVY DUTY NYLON HINGE/REMOVABLE COTTER PINS

Built to take heavy loads, 3/4" (19mm) wide x 1-3/8" (35mm) long x .040 (1mm) thick. Removable 3/64" (1.2mm) dia. cotter pin for maximum convenience and strength. Ideal for big airplanes. No. 257 (C) Heavy Duty Nylon Hinge 15/pkg.



36" (0.914M) ANTENNA HOUSING

Works great for airplanes, cars, boats and helicopters. 24/tube. Sold Individually. No. 511

HEAT SHRINK TUBING

The ideal solution for many of your modeling needs. This tubing has been specially formulated to shrink up to one half its original diameter simply by using a heat gun, soldering iron, or cigarette lighter. Ideal for insulating electrical splices, and also covering electrical plugs and connectors. Packaged in 3" (76mm) lengths.

No. 435 1/16" (1.5mm) Dia. Blue 4/pkg.

No. 436 3/32" (2.3mm) Dia. Green 4/pkg.

No. 437 1/8" (3.1mm) Dia. Red 4/pkg.

No. 438 3/16" (4.7mm) Dia. White 3/pkg.

No. 439 1/4" (6.3mm) Dia. Yellow 3/pkg.

No. 440 3/8" (9.5mm) Dia. Black 3/pkg.

No. 441 Assorted Pack 2 ea./pkg.

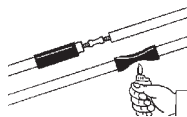

HEAT SHRINK TUBING SETS

Simplify your wiring by using the black shrink tubing for the negative connections and red for the positive. Designed to shrink up to 1/2 of it's original size.

No. 938 1/8" Heat Shrink Tubing Set (3.1mm) - 1.5" Long
4-Red & 4-Black / pkg.

No. 939 3/16" Heat Shrink Tubing Set (4.7mm) - 1.5" Long
4-Red & 4-Black / pkg.



NICKEL PLATED T-PINS

These nickel plated steel T-Pins are a must for all model building. Holds parts in place while gluing, sheeting, laminating, assembly, etc. An all around building aid. Strong, smooth and sharp, in 3 popular sizes. 100/pkg.

No. 252 1" (25mm)

No. 253 1-1/4" (32mm)

No. 254 1-1/2" (38mm)

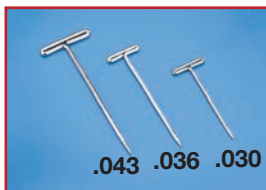

FOAM TAPE

Quality foam tape, super sticky on one side cuts down vibration. Ideal for wing saddles. 1/8" (3.1mm) H x 3/8" (9.5mm) W. 3 ft. (0.914M)/roll. **No. 163**



DOUBLE SIDED TAPE

Du-Bro's double sided tape assortment comes in 3 different thicknesses: 1/32"(0.7mm), 1/16" (1.5mm), 1/8" (3mm). Each size is diecut with four 1" (25mm) x 3" (76mm) pieces (12 sq. inches). Works great for mounting servos, receivers, speed controls, etc.

No. 634

R/C PROTECTIVE FOAM RUBBER

High quality foam rubber. Works great for protecting your receiver and fuel tank from vibration and also gives protection during a crash. Available in two sizes 1/4" (6.3mm) & 1/2" (12.7mm). 7" (177.8mm) x 11" (279.4mm) sheets. 1/pkg.

No. 513 1/4" (6.3mm)

No. 514 1/2" (12.7mm)



MIX-IT-STIX

These sticks are handy to have when mixing paint or epoxy. Inexpensive! 25/pkg. **No. 346**

EPOXY BRUSHES

A must for spreading epoxy and resin glue evenly. Also ideal for engine cleaning. 6/pkg. **No. 345**

HOOK & LOOP MOUNTING MATERIAL

Super tough material with a glue-like stick. Good for mounting receivers, batteries - unlimited uses! Adhesive back on one side for easy mounting.

1 - 1" x 12" set per pkg.

No. 348



WING TIP/TAIL SKID

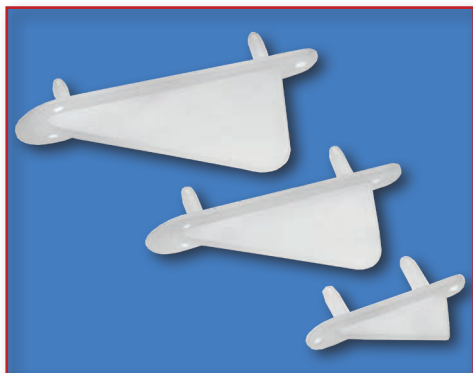

Protect those wing tips and tails! Easily installed by using CA or epoxy with holes provided for screw mounting. Available in three sizes for use on small to large aircraft. 2/pkg.

No. 990 Wing Tip/Tail Skid (1^{1/4}"")
0.7 grams/ea.

No. 991 Wing Tip/Tail Skid (2")
1.8 grams/ea.

No. 992 Wing Tip/Tail Skid (2^{3/8}"")
2.7 grams/ea.

E/Z MOUNT COWL SYSTEM

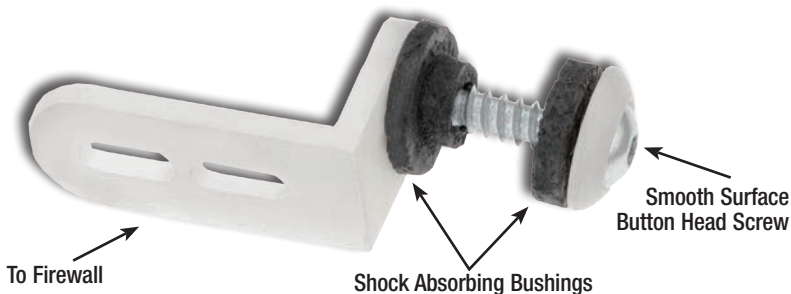

The E/Z Mount Cowl System provides an easy method for mounting your cowl. Complete with its "Soft-Shock Bushings", this system will reduce vibration and will not mar your painted cowl. Two (2) sizes available to work with any cowl and it is fully adjustable as well. Comes complete with all mounting hardware and "Smooth Surface Button Head Cowl Screws". 6/pkg.

No. 998 E/Z Mount Cowl System (.20-.90 Size Aircraft)

No. 999 E/Z Mount Cowl System (.90 & Above Size Aircraft)

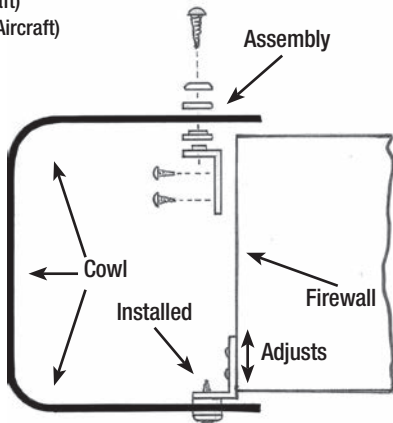
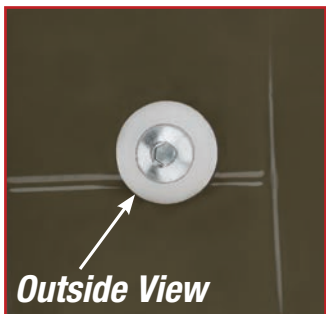

MICRO E/Z HINGE

Now you can hinge your control surfaces with these popular "pin style" hinges. Designed for micro indoor and park flyer models, these use metal pivot pins and multiple connecting arms for strength. Overall Length: 1.28" (1 ⁹/₃₂")

No. 937 Micro E/Z Hinge 15/pkg. (0.18 grams/ea.)



ELECTRIC FLYER HINGE TAPE

Our Electric Flyer Hinge Tape has great adhesion characteristics and is easy to remove. In addition, our hinge tape will not leave residue. 15ft X 1"W/pkg.

No. 916 Electric Flyer Hinge Tape

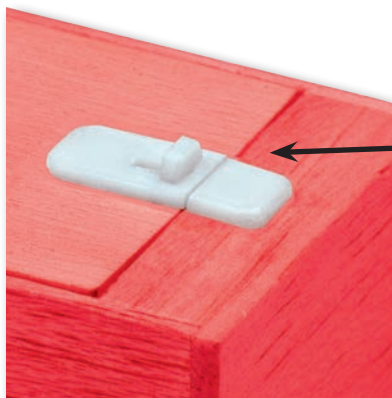

HATCH LATCH

A low profile design with a small spring locking latch for any doors, hatches, panels, etc. The Hatch Latch is secured in place using CA (cyanoacrylate). The unit is approx. 1" long X 3/8" wide. Can be painted.

No. 925 Hatch Latch 1/pkg. (0.75 grams/ea.)

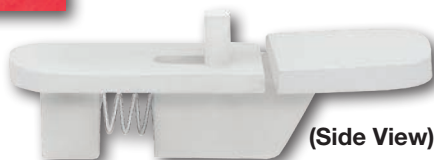

KWIK-SWITCH MOUNTS

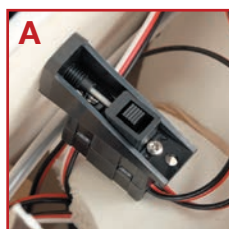

Kwik-Switch Mount
& Charging Jack
Inside view

(A) No. 203 Kwik-Switch Mount mounts your receiver battery switch securely in just minutes. Easy push (off)-pull (on) operation is effective and easy to see. Adaptable to any wall thickness up to 3/8". Works with all brands of on/off switches.

A Must for all Models!

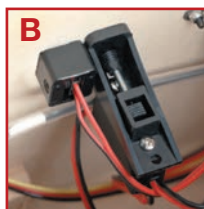

Kwik-Switch Mount
& Charging Jack
Inside view

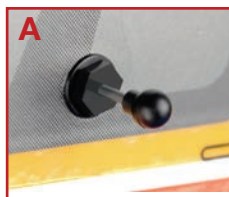

Kwik-Switch Mount
& Charging Jack
Inside view

(B) No. 207 Kwik-Switch Mount with Charging Jack. This has all the features of the No. 203 Kwik Switch Mount plus allows you to install the receiver charging plug to the mount for easy charging of the receiver battery. Set screw holds charging jack in place. Universal for all radio systems.

Protective cover keeps charging jack clean and free from exhaust residue and dirt.



Kwik-Switch Mount
& Charging Jack
"Off / Charging" Position



Kwik-Switch Mount
& Charging Jack
"On" Position

LONG DUAL SERVO ARMS

A new servo arm design for large aircraft. This dual arm allows for straight and in-line movement of the control surface. Made of long fiber composites, this arm is super strong and will provide the maximum security. The

Long Dual Servo Arms include heavy duty ball links for 4-40 pushrods and assembly hardware. The arms have 3 mounting holes for increased or decreased servo throw. 2/pkg.

Dimension from center to the end mounting hole: 1.343" (34.13mm).



MADE IN USA

- No. 3340 For Futaba® Servos (Black) (25 Tooth - I.D. .210")
- No. 3341 For JR® (Gray) - (23 Tooth I.D. .220")
- No. 3342 For Hitec®, Tower Hobbies® & Hobbico® Command Servos (White) (also works on Hitec HS-85, HS-60, HS-422, HS-85BB & HS-81 Micro) (24 Tooth I.D. .210")



Standard

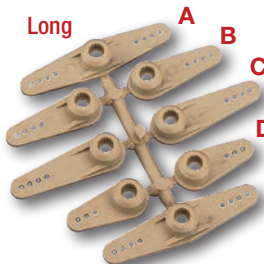

Long

SUPER STRENGTH SERVO ARMS

Designed for use in aircraft, car, boat & helicopter models. Unlike conventional servo arms, they are made of long fiber composites for added strength. Longer versions have increased throw allowing for greater movement in controls. 8/pkg.

Long Servo Arm Dimensions

Servo Arm	Distance From Center
A	1.152" (29.2mm)
2.305" (58.5mm) Overall	
B	.875 (22.2mm)
C	1.375 (34.9mm)
D	1.140 (28.9mm)

No. 670 Long - for Futaba® Servos (Black) - (25 Tooth I.D. .210")

No. 671 Long - for JR® (Gray) - (23 Tooth I.D. .220")

No. 672 Long - for Hitec®, Tower Hobbies® & Hobbico® Command Servos (White) (also works on Hitec HS-85, HS-60, HS-422, HS-85BB & HS-81 Micro) (24 Tooth I.D. .215")

No. 673 Standard - for Futaba® Servos (Black) - (25 Tooth I.D. .210")

No. 674 Standard - for JR® (Gray) - (23 Tooth I.D. .220")

No. 675 Standard - for Hitec® (White), Tower Hobbies® & Hobbico® Command Servos. - (24 Tooth I.D. .210")

The Following Servos Work With Our #670 & #673 "Futaba" Arms:

Ace Digital Servos: DS1313, DS1213, DS1015, DS1211, DS1013, DS1111

Ace Analog Servos: S1903, S1903MG, S1807MG, S2008MG

Bluebird: BMS-760DMG

FULL DUAL SERVO ARM

A new servo arm for the pull-pull in large aircraft. This new dual arm design allows for straight in-line movement. This super strong full arm includes 4-40 swivel ball links and hardware. There are four mounting positions and they are made from glass filled nylon for more strength. 1/pkg.



*Servo not included

MADE IN USA

Dimension from center to the end mounting hole: 1.5645" (39.75mm)

No. 3344 For Futaba® Servos (Black) - (25 Tooth I.D. .210")

No. 3345 For JR® (Gray) - (23 Tooth I.D. .220")

No. 3346 For Hitec®, Tower Hobbies® & Hobbico® Command Servos (White) (also works on Hitec HS-85, HS-60, HS-422, HS-85BB & HS-81 Micro) (24 Tooth I.D. .210")

ANTENNA TUBES

No matter what level of R/C driver you are, chances are, at sometime, you will break your antenna tube on a roll-over. Our replacement tubes are what you need. They are available in 6 different colors so you can match your body color. We also have the caps and tubing to hold everything in place.

- No. 2335 Antenna Tube w/ Cap (White) 1/pkg.
- No. 2336 Antenna Tube w/ Cap (Purple) 1/pkg.
- No. 2337 Antenna Tube w/ Cap (Yellow) 1/pkg.
- No. 2338 Antenna Tube w/ Cap (Red) 1/pkg.
- No. 2339 Antenna Tube w/ Cap (Blue) 1/pkg.
- No. 2340 Antenna Tube w/ Cap (Black) 1/pkg.
- No. 2341 Antenna Tube Assort. w/ Caps 6/pkg.
- No. 2342 Antenna Caps 2/pkg.
- No. 2349 Antenna Tube w/ Cap (Neon Blue) 1/pkg.
- No. 2350 Antenna Tube w/ Cap (Neon Green) 1/pkg.
- No. 2351 Antenna Tube w/ Cap (Neon Yellow) 1/pkg.
- No. 2352 Antenna Tube w/ Cap (Neon Pink) 1/pkg.
- No. 2353 Antenna Tube w/ Cap (Neon Orange) 1/pkg.
- No. 2354 Antenna Tube w/ Cap (Neon Light Orange) 1/pkg.
- No. 2355 Antenna Tube Assort. w/ Caps (Neon) 6/pkg.



NEON



STANDARD

MICRO ADJUSTABLE SERVO ARM

Designed to fit various micro servos with output shaft diameters from 0.152" (3.88mm) up to 0.185" (4.70mm). There are (4) arms included (2 with small dia. and 2 with larger dia. output shaft holes). Complete with washers and bolts and nuts to create a complete system. These servo arms are made from glass-filled, 100% virgin nylon for strength and durability. 2 each size / pkg. Distance from center of output shaft hole to center of furthest hole is: 0.922" (23.43mm). Weight: 0.88 grams

#989 Micro Adjustable Servo Arm (7 Tooth I.D. .215")

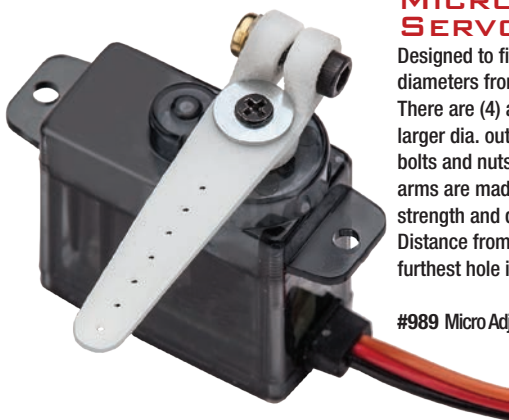

MINI E/Z CONNECTOR

Ideal for park flyers. Get the same Du-Bro quality only in an itzy bitzy size. Light weight aluminum design allows for up to .047 wire. 2-56 machine screw securely locks wire into place. Press fit our Mini E/Z Connector into a Mini Servo Arm and secure with snap washer.

- No. 845 Mini E/Z Connectors (.32 grams ea.) 2/pkg.
- No. 915 Mini E/Z Connectors (.32 grams ea.) 12/pkg.

MICRO SERVO ARM XL

AT LAST, servo arms long enough for the extra throw needed on the electric 3D airplanes! The DU-BRO Micro Servo Arm XL includes (4) single arms, as well as (2) double arms. These arms have had extra special attention given to weight, strength and performance. Made from 100% virgin nylon, they can stand up to the stress of 3D aerobatics and still remain lightweight.

The Micro Servo Arm XL comes in (5) different versions to accommodate various micro servos on the market. Weights: Single = 0.20 grams / Double = 0.32 grams

- #930 Micro Servo Arm XL (for Futaba 3108M, 3114, S3154, Hitec HS-50 / 55 / 35D / 45HB, E-Flite, S75, Hurricane HFS5G) - (15 Tooth I.D. .145")
 #931 Micro Servo Arm XL (for JR 241, JR281, Spektrum DS 821) - (23 Tooth I.D. .220")
 #934 Micro Servo Arm XL (for Hitec HS-56HB / 65HB / 65MG) - (25 Tooth I.D. .175")
 #985 Micro Servo Arm XL (for ParkZone SV80) - (28 Tooth I.D. .175")
 #986 Micro Servo Arm XL (for Spektrum DSP60, E-Flite S60 & DS75H) - (20 Tooth I.D. .145")

(Check www.dubro.com for the most up to date servo combinations)

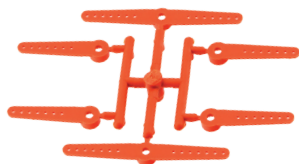

PART NO.	SERVO ARM COLOR
930	Black
931	Grey
934	Red
985	Yellow
986	Orange

E/Z CONNECTORS

Available in 3 different styles to fit all your installation requirements. Comes complete with all hardware.

- No. 121 (A) E/Z Connector (brass), for .072 (2-56) wire. 2/pkg.
 No. 605 (A) E/Z Connector (brass) bulk pack, for .072 (2-56) wire. 12/pkg.
 No. 608 (B) Kwik Grip E/Z Connector for .072" (2-56) wire. Use 3/32" wrench (not incl.) 2/pkg.
 No. 489 (C) Heavy Duty E/Z Connector (Steel), for .072 (2-56) wire. 2/pkg. (Use 3/32 Allen Wrench-not included)
 No. 490 (C) Heavy Duty 4-40 E/Z Connector (Steel), for .093 (4-40) wire. 2/pkg. (Use 3/32 Allen Wrench-not included)
 No. 3358 (D) Replacement E/Z Connector Washers for #121, 489, 605 & 608. 6 steel & 6 plastic/pkg.

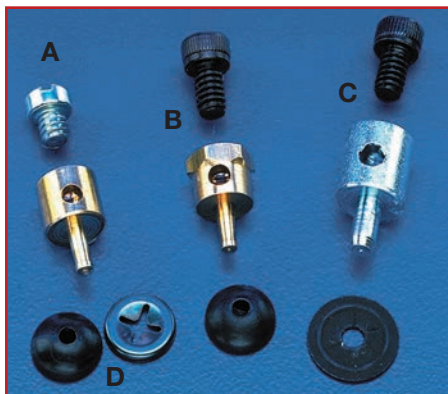

NEW

SQUARE-LOK PUSHROD CONNECTORS

Allows for a wrench to be applied for extra torque when needed. Comes with all hardware.

- No. 968 Square-Lok Pushrod Connector
 .072 (2-56) wire. 2/pkg.
 No. 969 Square-Lok Pushrod Connector
 .072 (2-56) wire. 12/pkg.



SUPER STRONG T-STYLE NYLON CONTROL HORN

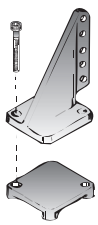

Stronger than conventional nylon control horns, these aerodynamically designed Super Strong control horns come complete with back plate and 2-56 x 1/2" socket head cap screws for easy installation. 1-3/8" long with 5 adjustment positions. 2/pkg. No. 716

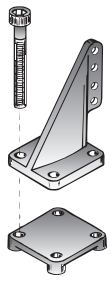

SUPER STRONG LARGE SCALE T-STYLE NYLON CONTROL HORNS

These large scale T-Style control horns were aerodynamically designed with large scale airplanes in mind. 1-3/8" long with 4 adjustment positions and 4 mounting holes. Comes complete with back plate and mounting screws. 2/pkg. No. 366

1/2A T-STYLE CONTROL HORNS

Nylon 3/4" long with 4 adjustment positions. Includes 2 control horns centered on base, 2 self threading nut plates and four 2-56 x 3/8" screws. 2/pkg. No. 107

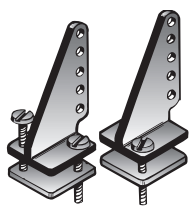
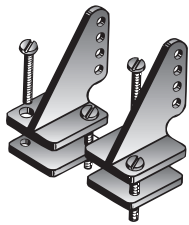

T-STYLE NYLON CONTROL HORNS

1-1/8" long with 5 adjustment positions. Each set includes: 2 control horns that are centered on base, 2 self threading nutplates and four 2-56 x 5/8" screws. 2/pkg. No. 237

NYLON CONTROL HORNS

1-1/8" long with 4 adjustment positions. Includes 1 right and 1 left control horn. 2 self threading nut plates and four 2-56 x 5/8" screws. 2/pkg. No. 105

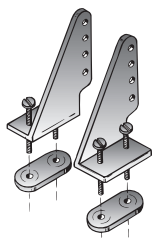

ADJUSTABLE CONTROL HORN

Our adjustable control horn mounts between two molded nylon pads for a strong solid mount. A 1-3/4", 5-40 bolt allows you the full range of height adjustment. Recommended for .60 powered aircraft and smaller. 2/pkg. No. 493

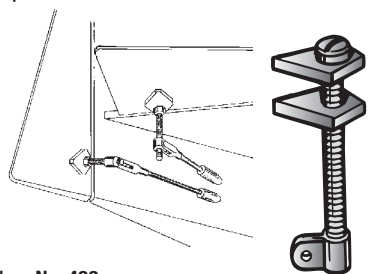

MICRO RAZOR CONTROL HORN

Designed for medium size indoor and park flyer models. This "open frame" design is light but strong. Complete with bottom support plate and two adjustment positions. Overall height: 0.8125" (13/16"). 2/pkg. (0.49 grams/ea.)

No. 936 Micro Razor Control Horn-Black

MADE IN USA



MICRO CONTROL HORN

Our Micro Control Horn measures 1/2" in height and comes with a pin molded on the bottom flat for easy installation and secure gluing. Pin can be trimmed off if not desired. Ideal for indoor and park flyers. 2/pkg. No. 848 (A) Micro Control Horn (.11 grams ea.)

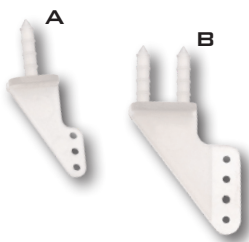

MICRO² CONTROL HORN

Our Micro² Control Horn is 5/8" in height and is great for the larger scale micro aircraft. No. 919 (B) Micro² Control Horn (.28 grams ea.)

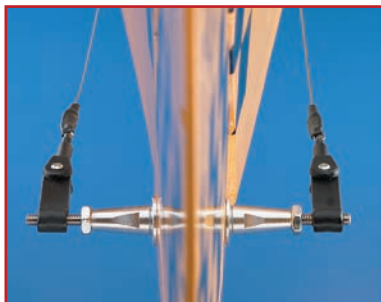

U.S. Patent #6,755,376

HEAVY DUTY DUAL CONTROL HORN SYSTEM

THINK BIG! These Heavy Duty Dual Control Horn Systems are what you need! Designed for pull-pull control. This is the latest in innovative design. The self-adjusting horns will mount straight (90° to center line of control surface) against the angled control surface, no wedges, no shims! Two sizes available.

For medium to large aircraft .40 to .91 comes complete with high quality aluminum horns, washers, steel 6-32 long shaft, nuts, horn arms, and kwik-links (for 2-56 rods). Threaded rod is 3 3/4". 2/pkg. **No. 880**

For large aircraft .91 & larger, comes complete with high quality aluminum horns, washers, steel 8-32 long shaft, nuts, horn arms, and clevis (for 4-40 rods) with aluminum pivot pins. Threaded rod is 4". 2/pkg. **No. 882**

Contains everything from **No. 880** plus 15 ft. of nylon coated 27 lb. stranded steel cable (.020 dia.) and all mounting hardware for 2-56. **No. 881**

Contains everything from **No. 882** plus 15 ft. of nylon coated 60 lb. stranded steel cable (.032 dia.) and all mounting hardware for 4-40. **No. 883**

No. 880 HD Dual Control Horn System (.40-.91)

No. 881 HD Dual Pull-Pull System (.40-.91)

No. 882 HD Dual Control Horn System (.91 & up)

No. 883 HD Dual Pull-Pull System (.91 & up)

No. 895 Replacement Crimps for # 517,881 (12/pkg.)

No. 896 Replacement Crimps for # 518,883 (12/pkg.)

HD ADJUSTABLE CONTROL HORN

Think BIG! These HD Adjustable Control Horns are the latest in a family of innovative control horn applications. The self-adjusting horn will mount straight (90° to center line of control surface) against the angled control surface using no wedges or shims! With two sizes available, your aircraft will be even more functional as well as stylish.

Cat. No. 912 (.40-.91) 2/pkg. (Bolt length: 2 1/2")

Cat. No. 913 (.91 & above) 2/pkg. (Bolt length: 2 3/4")



U.S. Patent #7,040,571



HEAVY DUTY CLEVIS HORN SYSTEM

A complete mounting system for large aircraft that can be configured as a pull-pull or as two single control horns. Self-adjusting design will mount at 90° to center line of the control surface. This system includes premium socket head bolts which provide a non-slip head while installing horns. The clevis horns include 4-40 heavy duty swivel ball links for "no-slop" precision control. Includes: (1) 4" Threaded Rod & (2) 2-3/4" Socket Head Bolts.

No. 3355 (8-32)

No. 3356 (10-32)

CLEVIS W/BALL LINK

(Available Separately)

No. 3365 (8-32) **No. 3366** (10-32)

HEAVY DUTY CONTROL HORN SYSTEM

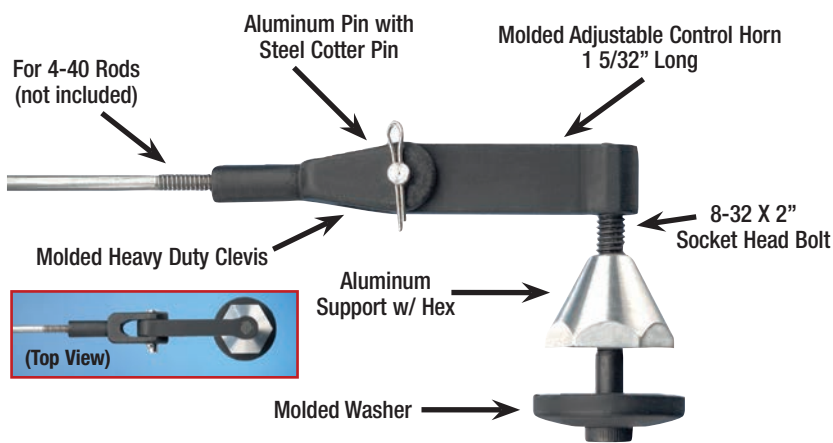

Designed with BIG planes in mind! This product has plenty of clearance from the hinge line with 1 5/32" long control horn, the precision fit. Steel cotter pins securely hold aluminum pin in place.

No. 866 Heavy Duty Control Horn System (For .91 & Above) 2/pkg.

HEAVY DUTY CONTROL HORN (FOR .40 - .91)



This system is designed for medium to large aircraft using 2-56 control rods and standard clevises. Bolt is 6-32 X 1 1/2" long. Adjustable horn is 3/4" long.

No. 867 Heavy Duty Control Horn (For .40-.91) 2/pkg.

HEAVY DUTY CONTROL ARMS & CLEAVES



No. 878 (For .40-.91) For medium to large aircraft .40 to .91 size, includes horn arms, and clevises (for 2-56 rods) with aluminum pivot pins. 2/pkg.



No. 879 (For .91 & Above) For large aircraft .91 and larger. Includes horn arms, and clevises (for 4-40 rods) with aluminum pivot pins. 2/pkg.



MADE IN USA

HEAVY DUTY DUAL CONTROL HORN

This new control horn design is made from high strength nylon and is perfect for large aircraft. The dual arm feature allows for even, in-line movement of the control rod.

Includes a support plate with mounting bolts and a heavy duty swivel ball link for 4-40 control rod. Height from the base to the pivot center is 1". 2/pkg.

No. 3352 Heavy Duty Dual Control Horn

HEAVY DUTY XL DUAL CONTROL HORN

This "jumbo" size control horn has been designed for giant scale aircraft and it boasts two adjustment positions for a superior set-up.

Made from high strength nylon, you will have the confidence you need when you hit the flight line. With a 1" square support plate and 1" long 4-40 mounting bolts, your install will be rigid! The included 4-40 swivel ball link provides an easier fit and the strong connection you demand.

No. 3353 Heavy Duty XL Dual Control Horn



MADE IN USA

HEAVY DUTY CLEVIS HORN SYSTEM

A complete mounting system for large aircraft that can be configured as a pull-pull or as two single control horns.

Self-adjusting design will mount at 90° to center line of the control surface. This system includes premium socket head bolts which provide a non-slip head while installing horns.

The clevis horns include 4-40 heavy duty swivel ball links for "no-slop" precision control.

1 set/pkg. (as shown in photo).

No. 3355 Heavy Duty Clevis Horn System (8-32)
For medium to large aircraft. Includes: 8-32 X 4" threaded rod and (2) 8-32 X 2-3/4" socket head bolts.

No. 3356 Heavy Duty Clevis Horn System (10-32)
For large aircraft. Includes: 10-32 X 4" threaded rod and (2) 10-32 X 2-3/4" socket head bolts.



SPRING STEEL SOLDER & KWIK-LINKS

Spring Steel Kwik-Links are the tried and true top quality kwik-link. Ideal for any control linkage and hook-up. Use with threaded rods or threaded couplers. Solder

Kwik-Links are nickel plated for a strong, attractive and easy to solder connector for servo or horn.

- No. 109 (A) 2-56 Spring Steel Kwik-Link -.072 dia. wire w/link guards. 2/pkg.
 No. 600 (A) 2-56 Spring Steel Kwik-Link -.072 dia. wire w/link guards, Bulk Pack. 12/pkg.
 No. 304 (B) 4-40 Spring Steel Kwik-Link -.093 dia. wire w/spring keepers. 2/pkg.
 No. 601 (B) 4-40 Spring Steel Kwik-Link -.093 dia. wire w/spring keepers, Bulk Pack. 12/pkg.
 No. 112 (C) 2-56 Solder Kwik-Link -.072 dia. wire w/link guards. 2/pkg.
 No. 603 (C) 2-56 Solder Kwik-Link -.072 dia. wire w/link guards, Bulk Pack. 12/pkg.
 No. 305 (D) 4-40 Solder Kwik-Link -.093 dia. wire w/spring keeper. 2/pkg.
 No. 604 (D) 4-40 Solder Kwik-Link -.093 dia. wire w/spring keeper, Bulk Pack. 12/pkg.

NYLON KWIK-LINKS

These sure-lock nylon kwik-links are self-threading nylon for 2-56 rods or threaded couplers. Mini Nylon Kwik-Links are perfect for 1/2A airplanes or any throttle hook-up.

- No. 122 (E) Nylon Kwik-Link 2/pkg.
 No. 602 (E) Nylon Kwik-Link Bulk Pack 12/pkg.
 No. 669 (E) 2MM Nylon Kwik-Link (for replacements on imported A.R.F.'s and kits) 2/pkg.
 No. 228 (F) Mini Nylon Kwik-Link 2/pkg.

LONG ARM MICRO CLEVIS

Our Long Arm Micro Clevis has a throat depth of 0.6" (15.2 mm) which allows for a maximum control angle. The clevis has a perfect snap fit closure with a color matched silicone safety band to securely hold the arms. The .032" and .047" Long Arm Micro Clevis' come with the threaded coupler, while the .062" clevis will thread directly onto the .062" pushrod (coupler not included). 2/pkg.
 Weight: .032" (0.01 grams ea.) - .047" (0.04 grams ea.) - .062" (0.06 grams ea.)

- No. 973 Long Arm Micro Clevis (.032")-Black
 No. 974 Long Arm Micro Clevis (.047")-Black
 No. 975 Long Arm Micro Clevis (.062")-Black



MADE IN USA

MICRO CLEVIS

You ask...we deliver. Our Micro Clevis comes complete with removable .031 L-shaped clevis pins. The silicone tubing securely holds pin in place. Includes threaded coupler for .032 wire, which can be soldered or glued with cyanoacrylate. Extra pins included in package.

*(For .047 wire applications, see Micro² Clevis below).

- No. 917 Micro Clevis 2/pkg. (0.35 grams/ea.)
 No. 921 Micro² Clevis 2/pkg. (0.35 grams/ea.)

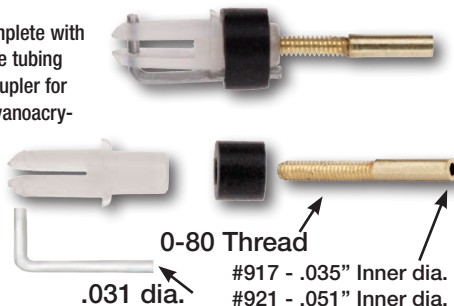

SAFETY LOCK KWIK-LINK

The Safety Lock Kwik-Link offers everything a modeler could want in a clevis and more. Simply put, it's ingenious, a grand slam! **Features:**

- Self tapping - leaving no slop on threads.
- Square shank for easy installation & adjustment.
- Plated stepped steel pin - no binding on control horns or servo arms.
- Plated steel safety lock slides into groove on pin for a secure and solid lock.
- Safety lock is mounted in a trac system on clevis to help prevent losing it.
- 3 sizes available - 2MM, 2-56 and 4-40 in packages of 2 each or 12 per package.
- Ideal for upgrading or replacement on A.R.F.'s.
- Super strong, super tough.
- More strength than you'll ever need.
- 10% lighter than steel clevis'.
- Size stamped on safety lock for positive identification.



U.S. Pat. # 6,364,566

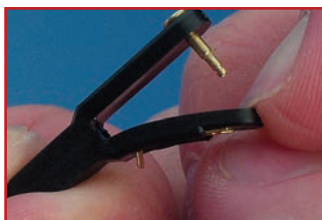

- No. 815 2-56 Safety Lock Kwik-Link. 2/pkg.
- No. 816 2-56 Safety Lock Kwik-Link. 12/pkg.
- No. 817 4-40 Safety Lock Kwik-Link. 2/pkg.
- No. 818 4-40 Safety Lock Kwik-Link. 12/pkg.
- No. 819 2MM Safety Lock Kwik-Link. 2/pkg.
- No. 820 2MM Safety Lock Kwik-Link. 12/pkg.
- No. 821 Replacement Slide Lock. 12/pkg.

E/Z LINK (.072 - 2-56 WIRE)

Snap fit on .072 wire, simply bend 90° angle on pushrod and install E/Z Link onto pushrod (No Z/Bend required). Super lightweight design, ideal for all models using .072 pushrods. 4/pkg.

No. 855 E/Z Link

E/Z LINK (.093 - 4-40 WIRE)

No. 885 E/Z Link for .093 wire. (4/pkg.)



MICRO & MICRO²E/Z LINK

Snap fit on wire, simply bend 90° angle on pushrod and install E/Z Link onto pushrod (No Z/Bend required). Super lightweight design, ideal for indoor and park flyers. 4/pkg.
Weight: .032" (0.01 g/ea.) - .047" (0.04 g/ea.) - .062" (0.06 g/ea.)

- No. 849 Micro E/Z Link for .032" wire
- No. 920 Micro² E/Z Link for .047" wire
- No. 940 Mini E/Z Link for .062" wire

METRIC CLEVIS

The perfect solution to replace broken or inferior metric clevis' on imported aircraft. Works on pushrods ranging in size from 1.3 mm to 1.4 mm. The clevis pin is 0.0635" This is a perfect upgrade or replacement for your stock metric clevis! 4/pkg No. 808



NICKEL PLATED 4-40 ROD ENDS

Perfect for many 1/4 scale applications, including strut attachments, flying wires, tailfin stab bracing and bi-plane aileron connectors. 2/pkg

No. 302 Threaded (Use w/4-40 threaded rod)

No. 303 Steel Solder (Use w/.093 rod)



NICKEL PLATED 4-40 STEEL ROD END ASSEMBLY

Perfect for many 1/4 scale applications, including strut attachments, flying wires, tailfin stab bracing and bi-plane aileron connectors. Complete set includes (2) Threaded Rod Ends,

(2) solder rod ends, (4) No. 202 Steel Straps, (2) 12" long .093 dia. rod with 3/4" 4-40 thread, (4) 1/4" x 4-40 screws and (4) 4-40 nuts. 2/pkg.

No. 205



NICKEL PLATED STEEL STRAPS

Pre-drilled for 4-40 screws or bolts. These 1/16" (1.5 mm) thick straps fit perfectly into Du-Bro No. 302 and No. 303 Rod Ends. They can be bent or reworked to your applications. Straps are 1-5/8" in length. 4/pkg.

No. 202



(0.687" / 11/16")

90° NYLON BELLCRANK ASSEMBLY

Set includes 90° nylon bellcrank with brass bushing, 4-40 x 3/4" (19mm) screw, washer, lock washer and 4-40 nut. **No. 167**

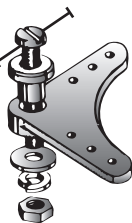
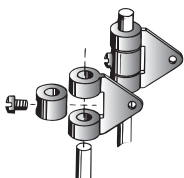

STRIP AILERON HORN CONNECTORS

Simplifies servo link hook-ups. Includes (2) 3/32" Dura-Collars, (2) nylon horn connectors and (2) slot head screws. For .093 wire. 2/pkg. **No. 103**

MICRO 90° BELLCRANK SYSTEM

Mounts inside wing for use with ailerons and control linkage systems. Bellcrank injection molded and comes complete with mounting hardware.

No. 851 Micro 90° Bellcrank System (.67 grams)

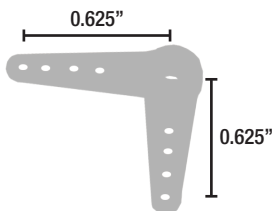

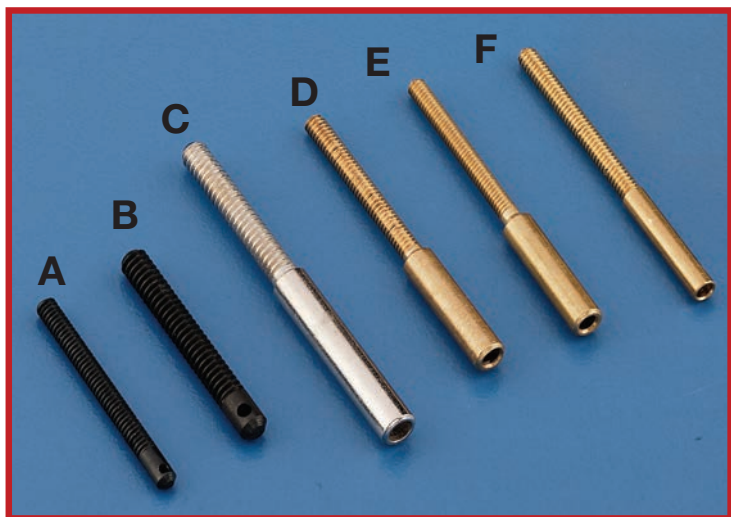

RIGGING COUPLERS

These couplers thread into Du-Bro steel Kwik-Links and are perfect for cable controls, flying wires and other linkage requirements. 7/8" (22.2mm) long, 2-56 thread, 1/32" (0.8mm) eye. 4-40 rigging couplers are 7/8" (22.2mm) long and .050 (1.2mm) eye. 4/pkg.

No. 201 (A) 2-56 (Steel)

No. 618 (B) 4-40 (Steel)

4-40 THREADED COUPLERS

Machined out of steel for maximum strength. Thread length is 5/8" (15.8mm) long and overall length is 1-1/2" (38mm). Nickel plated for easy soldering. 2/pkg.

No. 336 (C) 4-40 Thread, .093 dia.

THREADED COUPLERS

Designed for use with Du-Bro Kwik-Links and ball links. No. 111 & 212 are 2-56, threaded 3/4" (19mm) long. 2mm Threaded Couplers are used with Du-Bro's 2mm Nylon Kwik-Links & can also be soldered on Du-Bro's 2mm push-rods. The coupler length for all part nos. is 1-1/4" (31.7mm) long.

No. 212 (D) For .072 wire 5/pkg.

No. 695 (E) For 2mm dia. wire 2/pkg.

No. 111 (F) For 1/16" dia. wire 2/pkg.

1/4 SCALE TURNBUCKLES

They not only look good, they are fully functional. Attached to your guy wires (flying wires), they add a working touch of class. Nickel plated steel with 1/16" (1.5mm) eye & 4-40 thread. 2/pkg

No. 300 (1.281 [1-9/32"]-Closed / 1.671 [1-43/64"]-Open)



CONTROL OVER-RIDE SERVO SAVER

Adjustable, spring action assembly protects servo from shock and stalling. Excellent for throttle or rubber nose-wheel hookups. Light and heavy duty springs included for .072 dia. control rods. 1/pkg. No. 120

THREADED RODS

Can be used in conjunction with nylon or steel Kwik-Links or with ball links where extra long pushrods are needed. Bendable and strong. Rods are available with 3/4" (19mm) thread on one end (.072 rods w/2-56 thread) (.093 rods with 4-40 thread). Sold individually.

- No. 976 (A) 12" (305mm) .062 rod 36/tube
- No. 977 (A) 30" (762mm) .062 rod 36/tube
- No. 172 (A) 12" (305mm) .072 rod 2-56 thrd. 36/tube
- No. 801 (A) 12" (305mm) .072 rod 2-56 thrd. 6/pkg.
- No. 173 (A) 30" (762mm) .072 rod 2-56 thrd. 36/tube
- No. 890 (A) 48" (1220mm) .072 rod 2-56 thrd. 24/tube
- No. 144 (B) 12" (305mm) .093 rod 4-40 thrd. 24/tube
- No. 802 (B) 12" (305mm) .093 rod 4-40 thrd. 6/pkg.
- No. 145 (B) 30" (762mm) .093 rod 4-40 thrd. 24/tube
- No. 891 (B) 48" (1220mm) .093 rod 4-40 thrd. 24/tube
- No. 693 (A) 2 MM x 305mm 36/tube
- No. 694 (A) 2 MM x 762mm 24/tube



FULLY THREADED RODS

12" (305mm) fully threaded rods are stainless steel and perfect for making custom lengths to the size you need. Available in 2-56, 4-40 and 6-32 thread. 12/tube. Sold Individually.

- No. 378 (C) 2-56 Fully Threaded Rod
- No. 379 (C) 4-40 Fully Threaded Rod
- No. 958 (C) 6-32 Fully Threaded Rod



20" & 30" MICRO PUSHROD SYSTEMS

Micro Pushrod Systems come complete with (2) pushrods, (2) pushrod housings, (2) Micro E/Z Links (90° bend is already on pushrods) and (2) Mini E/Z Connectors. Ideal for indoor and park flyers.

- No. 847 20" Micro Pushrod System-for .032 Pushrods (6.3 grams) O.D. .075"
- No. 852 30" Micro Pushrod System-for .032 Pushrods (9.3 grams) O.D. .075"
- No. 922 30" Micro² Pushrod System-for .047 Pushrods (11.4 grams) O.D. .090"
- No. 941 30" Micro Pushrod System-for .062 Pushrods (36 grams) O.D. .105"

MICRO PUSHROD GUIDE

A versatile guide/support for control linkages, throttle, etc. Three holes make it easy to accommodate different set-ups. The Micro Pushrod Guide can be used on foam, wood, etc. For foam, just press pins through and cement with CA or epoxy and cut off any protruding pins. If used on balsa, pre-drill small holes. The guide holes are 0.080" diameter.

Cat. No. 923 (0.20 grams/ea.) 4/pkg.

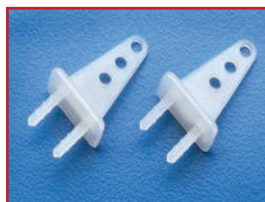

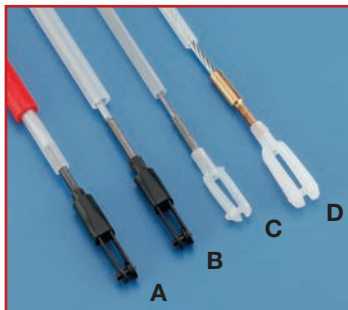

LAZER ROD PUSH RODS

Using a highly controlled process, Du-Bro has devised a way to stabilize the Push Rod material so that neither heat nor cold has much effect on trim settings. In fact, in our tests, we found less growth or shrinkage than any plastic push rod on the market. Again, Du-Bro has made a good product even better. Just look at these features!

- The red outer housing has 6 contact points giving the inner push rod a smooth positive control.
- Inner push rod is translucent in color to better match your color scheme and give your model a more realistic look.

- 4" 2-56 Threaded Rod slides inside inner push rod to give a stiffer exit to control horn.
- Two push rods per package - available in 36" & 48" lengths.
- All hardware included.
- Just the right flexibility and strength for the perfect installation.

No. 500 (A) 36" (914mm) Lazer Rod 2/pkg. O.D. .220"

No. 501 (A) 48" (1219mm) Lazer Rod 2/pkg. O.D. .220"

Also available are Lazer Rod Push Rod Exits for a clean look on your aircraft.

No. 502 (E) Lazer Rod Push Rod Exits 2/pkg.



NY-STEEL KWIK-ROD ASSEMBLY

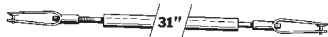

No shrink, no stretch, free running and fully adjustable at control horn. Complete 31" assembly includes 1 No. 112 Solder Link, 1 No. 109 Kwik-Link, 1 Flexible Nylon Sleeve, 1 30" long .072 dia. rod with 3/4" 2-56 thread and 2 link guards. 1/pkg. No. 102 (B)



MINI NY-STEEL PUSHROD ASSEMBLY

Perfect for 1/2A airplanes. No shrink, no stretch, free

running pushrod assembly. Light weight, flexible and strong. Complete 20" assembly includes 4 No. 228 Mini Kwik-Links, 4 Spring Threaded Couplers, two 20" long .047 dia. wire and 2 nylon sleeves. 2/pkg. No. 113 (C)

ENGINE CONTROL FLEX-CABLE ASSEMBLY

Provides the ultimate in control cable assembly. Highly flexible, free running and adjustable at control horn. Complete assembly includes:

(1) each of No. 228 Mini Kwik-Link, No. 112 Solder Link, 2-56 Threaded Coupler, Flex-Cable & Nylon Sleeve. No. 343 & 344 includes 1 No. 122 Nylon Kwik-Link & the above parts. 1/pkg.

No. 165 (D) 20" (508mm)

No. 343 (D) 36" (914mm)

No. 344 (D) 48" (1219mm)



MICRO AILERON SYSTEM

Our Micro Aileron System is designed for indoor and park flyer aircraft. Complete with Micro E/Z Link (2), Mini E/Z Connector (2), 1/32 (.032) push rods (2) with "L" bend wire (2), and plastic bearing (2). The ideal set up for putting ailerons on your aircraft.

No. 850 Micro Aileron System (3.2 grams)



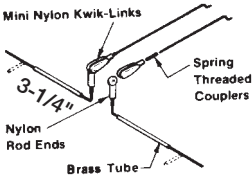

1/2A AILERON LINKAGE

Easy to install, light and compact. Especially made for 1/2A airplanes. Features Mini Kwik-Links, Spring Threaded Couplers, Nylon Rod Ends, Brass Tubes and 1/16" dia. wire. 1 set/pkg. **No. 231**

STRIP AILERON LINKAGE

Can be used on any high, mid, or low wing plane. Complete, fully adjustable 22 piece set includes all hardware for 2-56 thread spring steel Kwik-Link and link guards for safety under heavy stress. Horn wire 3/32" dia. 1 set/pkg. **No. 101**

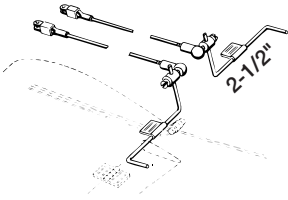
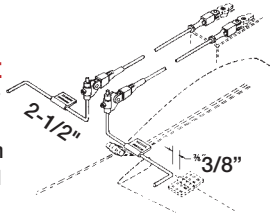

STRIP AILERON BALL LINK

Fully adjustable 16 pc. aileron hook-up. No play, no binding, super precision. Eliminates differential throw. Use on high, mid, or low wing planes utilizing strip ailerons. Includes all hardware for 2-56 thread and link guards for safety under heavy stress. Horn wire 3/32" dia. 1 set/pkg. **No. 186**

E/Z ADJUST NYLON HORN BRACKET

Includes E/Z Adjust Nylon Horn Bracket for easy adjustment. 4/pkg.

No. 557 3/32" E/Z Adjust Horn Bracket (For 4-40 Thread)

No. 559 Heavy Duty E/Z Adjust Horn Bracket (For 6-32 Thread)

E/Z Adjust Nylon
Horn Bracket



MICRO PULL-PULL SYSTEM

This Micro Pull-Pull System gives you precision control! Comes complete with 4 Du-Bro Mini E/Z Connectors, 8 aluminum crimps, 10 feet of 10 pound test no stretch control line, and 4 micro adjustment pins. The Micro Pull-Pull System weighs 2.2 grams

No. 846 Micro Pull-Pull System (2.2 grams)



THROTTLE CABLE ASSEMBLY

Provides the ultimate in control cable assembly. Highly flexible, free running and adjustable at the throttle arm. Complete assembly includes one 20" Throttle Cable and Housing, one Solder Kwik-Link and one Heavy Duty E/Z Connector. 1/pkg. **No. 3105**

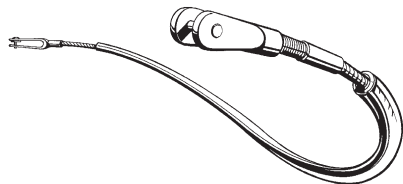

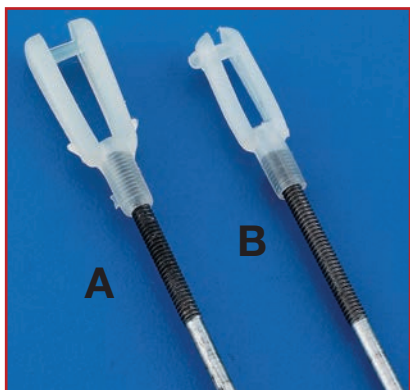

NYLON KWIK-LINK WITH ROD

Du-Bro's No. 122 Nylon Kwik-Link on a 12" .072 dia. rod with 3/4" 2-56 thread.

No. 123 (A) Sold individually or 12 pcs./tube

No. 184 (A) Skin packed 5 pcs./card.

No. 229 (B) Sold Individually or 18 pcs./tube.

Du-Bro's No. 228 Mini Nylon Kwik-Link on a 12" .072 dia. rod with 3/4" 2-56 thread.

No. 230 (B) Skin packed 5 pcs./card

KWIK-LINK WITH ROD

Complete assembly for any control linkage. Allows easy removal for on-the-field adjustments.

No. 108 12" long, .072 dia. rod 3/4" thread 2-56. Sold individually or 12 pcs./tube.

No. 185 12" long, .072 dia. rod 3/4" thread 2-56. Skin packed 5/card.

No. 306 12" long, .093 dia. rod 3/4" thread 4-40. Sold individually or 12 pcs./tube.

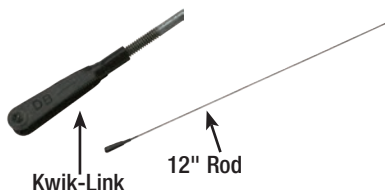

2-56 & 4-40 PULL-PULL SYSTEM

These Pull-Pull Systems are available in two sizes, 2-56 (27 lb.) and 4-40 (60 lb.). It comes complete with 15 feet of nylon coated cable and all mounting hardware. Ideal for pull-pull installations on rudder, elevator, tail wheels, etc. 1 set/pkg.

No. 517 (2-56) No. 518 (4-40)

No. 895 Replacement Crimps for # 517,881 (12/pkg.)

No. 896 Replacement Crimps for # 518,883 (12/pkg.)



30" PUSHROD HOUSING

This pushrod housing can be used with 2mm, 2-56 and 4-40 pushrods. 18/tube. Sold individually. O.D. .187" No. 700



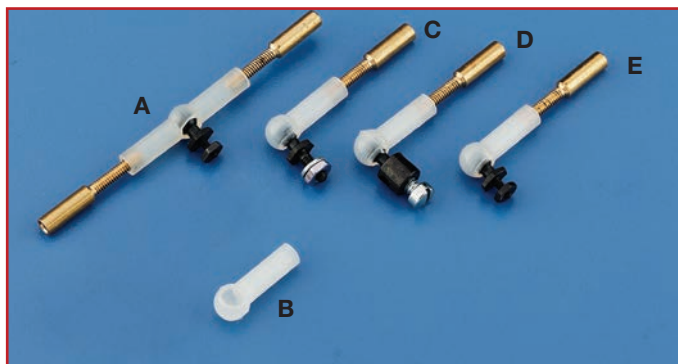

AILERON CONNECTOR BALL LINK

5-piece set includes one 2-way self-threading nylon socket, 2 threaded couplers 3/4" long with 3/8" 2-56 thread, for up to .072 wire, 1 ball threaded for 0-80 (1/16" dia. thrd.) and one 0-80 nut. 1/pkg. No. 183 (A)

BALL LINK SOCKETS

Self-threading nylon ball link sockets. When switching radios to another plane, you can keep the same trim setting for future flights by leaving the nylon links on the pushrods. For up to .072 wire. 4/pkg. No. 188 (B) 2-56

2-56 THREADED BALL LINK

5-piece ball link set, excellent for off-set steering, throttle and servo hook-ups. Ball is threaded for 2-56 nut. Threaded coupler 3/4" with 3/8" 2-56 thread, for up to .072 wire. Self-threading nylon socket, washer and 2-56 nut. 1/pkg. No. 181 (C) 2-56

AILERON HORN WIRE BALL LINK

Change old strip aileron connectors to ball link control. Fitting also useful as dual take off connectors. 8-piece set includes: 2 horn wire ball links for 3/32" dia. wire, 2 self-threading nylon sockets, 2 threaded couplers 3/4" long with 3/8" 2-56 thread for up to .072 wire and two 4-40 screws. 2/pkg. No. 189 (D)

1/16" THREADED BALL LINK

This 4-piece set fits perfectly in servo arm hole, bellcranks, nylon horns and throttle arms. Set includes 1 ball threaded for 0-80 (1/16" dia. thrd.), 1 (0-80) nut, 1 self-threading nylon socket, 1 threaded coupler 3/4" long, with 3/8" 2-56 thread for up to .072 wire. 1/pkg. No. 190 (E)

HEAVY DUTY 4-40 BALL LINK

3 Piece set, 4-40 threaded ball, and self-threading socket for 4-40 rod, 4-40 lock-nut. 1/pkg. No. 884



MICRO BALL LINK

The perfect connector for your micro/mini applications where space and weight are important. Our Micro Ball Link comes complete with a perfect snap fitting nylon socket and an 0-80 retaining nut. Also includes a threaded coupler which can be soldered or glued with CA. The coupler comes in two different sizes for .032" and .047" wire. 2/pkg.

No. 928 Micro Ball Link for .032" 2/pkg. (0.45 grams/ea.)

No. 929 Micro Ball Link for .047" 2/pkg. (0.45 grams/ea.)



DU-BRO Ball Links offer smooth friction-free operation for multiple applications. Our Heavy Duty Ball Links are great for giant scale aircraft. Our E/Z Adjust Ball Links are also heavy duty and include a tension adjustment screw on the ball. The Dual Swivel Ball Links are ideal for rudder/tailwheel, aileron, or any multiple control hook-up.

SWIVEL BALL LINKS

CAT. NO.	FITS ROD/TURNBUCKLE	SCREW SIZE	PER PKG.
368	2MM	2MM X 12MM	1
367	2-56	2-56 X 1/2"	1
860	2-56	2-56 X 1/2"	12
369	4-40	2-56 X 1/2"	1
497	4-40	4-40 X 5/8"	1
861	4-40	4-40 X 5/8"	12



HEAVY DUTY BALL LINKS

CAT. NO.	FITS ROD/TURNBUCKLE	SCREW SIZE	PER PKG.
899	4-40	4-40 X 5/8"	2
900	4-40	4-40 X 5/8"	12



E/Z ADJUST BALL LINK

CAT. NO.	FITS ROD/TURNBUCKLE	SCREW SIZE	PER PKG.
259	4-40	4-40 X 5/8"	1



DUAL SWIVEL BALL LINKS

CAT. NO.	FITS ROD/TURNBUCKLE	SCREW SIZE	PER PKG.
901	2-56	4-40 X 5/8"	2
902	4-40	4-40 X 5/8"	2



FOR EVEN MORE QUALITY DU-BRO BALL LINKS, GO TO PAGE #63

BUTTON HEAD SHEET METAL SCREWS

This design is by far the best way to mount servos, cowl, landing gear, etc. The large head of the screw acts as a washer and they also have a socket head for easy, no slip installation. Bright zinc plated with clear chromate 8/pkg.



- No. 525 2 x 3/8" No. 529 4 x 1"
- No. 526 2 x 1/2" No. 531 6 x 3/4"
- No. 527 4 x 1/2"
- No. 528 4 x 3/4"

Btn. Hd. Screw	Wrench Sizes Wrench Size
#2	.050
#4	1/16"
#6	5/64"
#8	3/32"



SOCKET HEAD CAP SCREWS

Assorted sizes 4/pkg.

- No. 309 2-56 x 1/4"
- No. 310 2-56 x 1/2"
- No. 311 2-56 x 3/4"
- No. 569 4-40 x 1/4"
- No. 570 4-40 x 3/8"
- No. 571 4-40 x 1/2"
- No. 572 4-40 x 3/4"
- No. 312 4-40 x 1"
- No. 313 4-40 x 1-1/4"
- No. 314 4-40 x 1-1/2"
- No. 574 6-32 x 1/4"
- No. 575 6-32 x 1/2"
- No. 576 6-32 x 3/4"
- No. 315 6-32 x 1"
- No. 316 6-32 x 1-1/4"
- No. 317 6-32 x 1-1/2"
- No. 577 8-32 x 1/2"
- No. 578 8-32 x 3/4"
- No. 318 8-32 x 1"
- No. 319 8-32 x 1-1/4"
- No. 320 8-32 x 1-1/2"
- No. 580 10-32 x 3/4"
- No. 581 10-32 x 1"
- No. 582 10-32 x 1-1/4"
- No. 583 10-32 x 1-1/2"

METRIC

- No. 2111 2.0 MM x 4
- No. 2112 2.0 MM x 6
- No. 2113 2.0 MM x 10
- No. 2114 2.0 MM x 12
- No. 2115 2.5 MM x 4
- No. 2116 2.5 MM x 6
- No. 2117 2.5 MM x 8
- No. 2118 2.5 MM x 10
- No. 2119 2.5 MM x 15
- No. 2120 3.0 MM x 4
- No. 2121 3.0 MM x 6
- No. 2122 3.0 MM x 8
- No. 2123 3.0 MM x 10
- No. 2124 3.0 MM x 15
- No. 2125 3.0 MM x 18
- No. 2126 3.0 MM x 20
- No. 2127 3.0 MM x 30
- No. 2271 3.0 MM x 50
- No. 2272 3.5 MM x 15
- No. 2273 3.5 MM x 20
- No. 2278 4.0 MM x 14
- No. 2279 4.0 MM x 18
- No. 2280 4.0 MM x 25
- No. 2281 4.0 MM x 35
- No. 2282 4.0 MM x 40



SOCKET SET SCREWS

- No. 2168 (A) 3 MM x 3 4/pkg.
- No. 2170 (C) 4 MM x 4 4/pkg.
- No. 2171 (D) 4 MM x 6 4/pkg.

BOAT LINE

(Stainless Steel)

- No. 3115 4-40 x 1/2"
- No. 3116 4-40 x 5/8"
- No. 3117 4-40 x 3/4"
- No. 3118 4-40 x 1"
- No. 3119 6-32 x 1/2"
- No. 3120 6-32 x 3/4"
- No. 3121 6-32 x 1"

Allen Wrench Sizes Screw	Wrench Size
2-56	5/64"
4-40	3/32"
6-32	7/64"
8-32	9/64"
10-32	5/32"



NYLON INSERT LOCK NUTS

Zinc plated aircraft quality nylon insert lock nuts. 4/pkg.

No. 168 2-56 No. 329 8-32
No. 170 4-40 No. 585 10-32
No. 171 6-32

CAR LINE

(Metric) Zinc plated
No. 2101 3MM
No. 2102 4MM
No. 2175 5MM

BOAT LINE

(Stainless Steel)
No. 3112 4-40
No. 3113 6-32

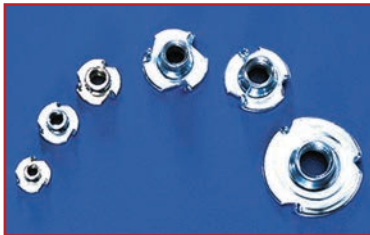

BLIND NUTS

Du-Bro's "permanent mount" blind nuts are available in 7 sizes. Used for mounting engines, landing gear, cowls, hatches, etc. The perfect mounting nut for hard to reach areas. Zinc plated. 4/pkg.

No. 133 2-56 No. 607 6-32 24/pkg.
No. 135 4-40 No. 347 8-32
No. 606 4-40 24/pkg.
No. 584 10-32
No. 136 6-32



SKT. HEAD SHEET METAL SCREWS

These zinc plated socket head sheet metal screws are fully threaded and have more applications than wood screws. The non-slip socket head makes hard to get at places easy! Perfect for mounting servos, landing gear straps, motor mounts, etc. Available in 9 sizes. 8/pkg.

No. 380 No. 2 x 3/8"
No. 381 No. 2 x 1/2"
No. 382 No. 4 x 1/2"
No. 383 No. 4 x 3/4"
No. 384 No. 4 x 1"
No. 385 No. 6 x 1/2"
No. 386 No. 6 x 3/4"

Allen Wrench Sizes	
Screw	Wrench Size
#2	5/64"
#4	3/32"
#6	7/64"
#8	9/64"

For DU-BRO Skt. Hd. Sheet Metal Screws Only.



STEEL HEX NUTS

Zinc plated. 4/pkg.

No. 560 2-56 No. 563 8-32
No. 561 4-40 No. 564 10-32
No. 562 6-32
CAR LINE (Metric)
No. 2103 2.0MM No. 2105 3.0MM
No. 2104 2.5MM No. 2106 4.0MM

FLAT HEAD SOCKET SCREWS

No. 2285 3.0 MM x 6 4/pkg.
No. 2286 3.0 MM x 8 4/pkg.
No. 2287 3.0 MM x 10 4/pkg.
No. 2288 3.0 MM x 12 4/pkg.
No. 2289 3.0 MM x 14 4/pkg.



FLAT HEAD SELF- TAPPING SCREWS

(ZINC PLATED / PHILLIPS HEAD)
No. 2299 3 MM X 20 8/PKG.





NYLON WING BOLTS

The outside hex head will fit your glo-plug/prop nut wrench, inside socket is made to fit standard allen wrenches. Both methods insure a safe, non-slip way to secure or loosen wing bolts. 4/pkg.

No. 164 10-32 x 2" (5/16" wrench)

No. 142 1/4-20 x 2" (7/16" wrench)

NYLON WING BOLTS XL

Our 3" Wing Bolts XL provide a longer reach to secure your wings. The large profile 0.5" dia. head works with a phillips or slotted head screwdriver. 4/pkg.

No. 993 1/4-20 x 3"

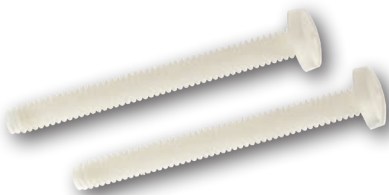

THREADED INSERTS

These brass threaded inserts are the perfect way to put threads into wood and mount engines to wood mounting rails. Threaded inserts make a simple and effective way to make wing hold downs. Can be used where blind nuts are hard to fit. Available in 3 sizes. 4/pkg.

No. 391 4-40

No. 392 6-32

No. 393 8-32



FLAT AND SPLIT WASHERS

Zinc plated. 8/pkg.

No. 321 No. 2 Flat

No. 322 No. 2 Split

No. 323 No. 4 Flat

No. 324 No. 4 Split

No. 325 No. 6 Flat

No. 326 No. 6 Split

No. 327 No. 8 Flat

No. 328 No. 8 Split

No. 586 No. 10 Flat

No. 587 No. 10 Split



CAR LINE

(Metric) Zinc plated

No. 2107 2.0MM Flat

No. 2108 2.5MM Flat

No. 2109 3.0MM Flat

No. 2110 4.0MM Flat

BOAT LINE

(Stainless Steel)

No. 3109 No. 4 Flat

No. 3110 No. 6 Flat

NYLON FLAT WASHERS

Today many modelers are using a socket head bolt with a nylon washer for wing bolts and many other uses. 8/pkg.

No. 635 No. 4 Flat

No. 636 No. 6 Flat

No. 637 No. 8 Flat

No. 638 No. 10 Flat

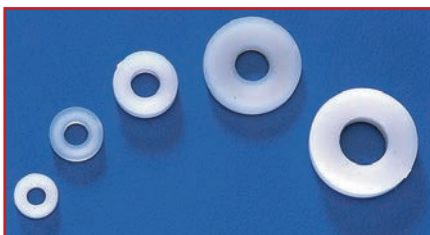

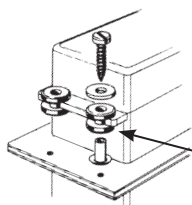

SERVO MOUNTING HARDWARE

Small servo mounting hardware. 60 pieces, enough for five servos. 20 sheet metal screws, 20 flat washers, 20 spacers.

5 sets/pkg. No. 114

*Rubber grommets not included

NYLON WING MOUNTING KIT

The up-to-date way to fasten wings to fuselage. Includes nylon bolts and nylon threaded blocks. 11 pc. set.

No. 256 1/4-20 thread, 2 sets/pkg.

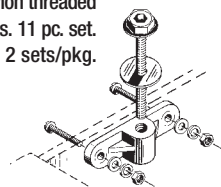

BOLT SETS WITH LOCK NUTS

Aircraft quality, includes 4 each of bolts, flat washers and lock nuts. High strength steel. 12 piece set. 4 sizes.

No. 174 (A) 2-56 x 1/2"

No. 176 (A) 4-40 x 1-1/4"

No. 177 (A) 6-32 x 1-1/4"

MOUNTING BOLT SETS W/ BLIND NUTS

For mounting engines. Includes 4 each of bolts, flat washers, and blind nuts. 16 pc. set. 3 sizes.

No. 125 (B) 2-56 x 1/2" No. 127 (B) 4-40 x 1-1/4"

No. 128 (B) 6-32 x 1-1/4"

SOCKET HEAD BOLT SETS WITH BLIND NUTS

Includes 4 each of bolts, flat washers, lock washers and blind nuts plus one allen wrench. 17 piece set.

Two sizes. High strength steel.

No. 129 (C) 4-40 x 1"

No. 130 (C) 6-32 x 1"

Allen Wrench Size: 4-40 = 3/32", 6-32 = 7/64"



SOCKET HEAD BOLT SETS WITH LOCK NUTS

12 piece set. 2 sizes.

No. 178 (D) 4-40 x 1" No. 179 (D) 6-32 x 1"

Allen Wrench Size: 4-40 = 3/32", 6-32 = 7/64"

SOCKET HEAD SERVO MOUNTING SCREWS

Comes with washer permanently attached to screw so you can't lose it.

Screw size: #2 X 7/16"

Cat. No. 893 (24/pkg.)



Install in Minutes

SNOWBIRD SKIS

No more seasonal flying! Du-Bro Snowbird Skis make it possible to fly all year. Easily mounts on airplanes with dural or wire landing gear in minutes. Snowbird Skis are manufactured out of high density polyethylene. Runners are molded right on the ski for better tracking. Ideal for up to .60 powered aircraft. Our Snowbird Skis flex on take-offs and landings yet remain in a positive lock position while in the air. All mounting hardware is included.

- No. 825 Snowbird Snow Skis MAIN (Black) (2 skis/pkg)
- No. 826 Snowbird Snow Skis NOSE (Black) (1 ski/pkg)
- No. 825-BL Snowbird Snow Skis MAIN (Blue) (2 skis/pkg)
- No. 826-BL Snowbird Snow Skis NOSE (Blue) (1 ski/pkg)
- No. 825-LG Snowbird Snow Skis MAIN (Lime Green) (2 skis/pkg)
- No. 826-LG Snowbird Snow Skis NOSE (Lime Green) (1 ski/pkg)
- No. 825-R Snowbird Snow Skis MAIN (Red) (2 skis/pkg)
- No. 826-R Snowbird Snow Skis NOSE (Red) (1 ski/pkg)
- No. 825-Y Snowbird Snow Skis MAIN (Yellow) (2 skis/pkg)
- No. 826-Y Snowbird Snow Skis NOSE (Yellow) (1 ski/pkg)

Dimensions:
2-9/16" X 9-1/4"
Weight:
Each Ski: 63.4 g



**EXTEND
YOUR
FLYING
SEASON!**





DU-BRO Park Flyer Snow Skis are shown here on GWS DHC-2 Beaver

PARK FLYER SNOW SKIS

Now you can fly your park flyer year round. DU-BRO's Park Flyer Snow Skis are vacuum formed with two runners on each ski for excellent tracking and steering on the snow. Ski's include a spring system to allow for flex on take-offs and landings, yet remain in a positive locked position while in air. The Park Flyer Snow Skis mount on your aircraft in minutes. Weight - (25.7 grams/pair) - Dimensions - (2 1/16" W X 7" L) No. 830 Park Flyer Snow Skis (2/pkg.)



MICRO PROFILE LANDING GEAR

STRONG, LIGHTWEIGHT, and VERSATILE!

Perfect for your profile "Foamie", "ARF's" and your original designs. Simple and strong mounting with all hardware included.

Rated for airplanes up to 1.5 pounds.

This is THE landing gear for all profiles up to 5/8" wide.

No. 943 Micro Profile Landing Gear (34 grams)

SUPER STRENGTH LANDING GEAR

Our Super Strength Landing Gear will absorb landings without bending out of shape, unlike wire and aluminum landing gear. Let's face it, not every landing is perfect and without our quality, flexible landing gear, your model may not recover from a hard landing. Weight: 4^{3/4} oz.

No. 789 Super Strength Landing Gear (for .35 - .60 Size Airplanes)

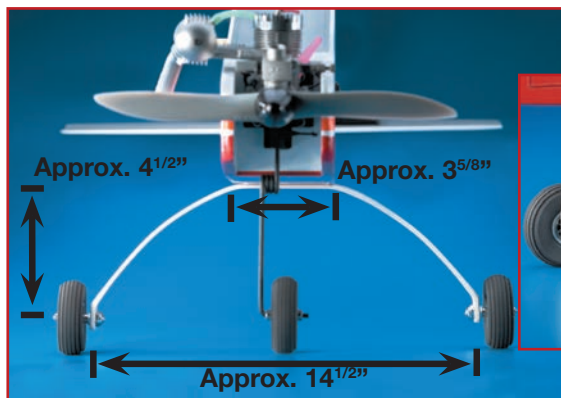

SEMI-SCALE TAILWHEEL SYSTEM

These complete ready-to-install Semi-Scale Tailwheel Systems are durable and great looking. Comes with rudder bracket and springs for control between rudder and tailwheel steering. Tailwheel included.



CAT. NO.	SIZE AIRCRAFT	LENGTH (A)	HEIGHT (B)	WHEEL DIA. (C)	WEIGHT (grams)
955	20-60	4.25"	2.375"	1"	18.5
956	40-90	4.875"	2.75"	1.1875"	20.5
957	60-120	5.625"	4"	1.625"	35

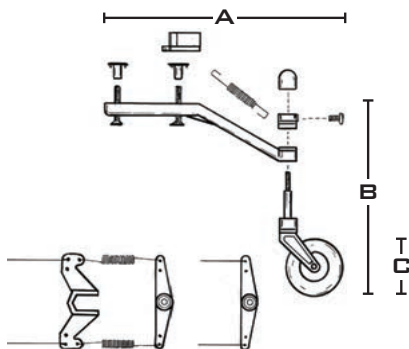

E/Z BRAKE - AIRCRAFT BRAKE SYSTEM

DESIGNED FOR 5/32" (.156") AND 4MM LANDING GEAR USING 2.25" - 3.50" DU-BRO WHEELS

The easily assembled E/Z Brake will function as a main or nose wheel braking system. This can be very useful in take-offs and landings where you need quicker stops and tighter turns. After the simple installation, an aircraft's receiver can be set up in many ways depending on the pilot's preference. A common method would be to attach the brake line to the elevator servo and utilize the trim to engage the brake. The tension can be adjusted so the brake can be on or off or to include more of a range allowing partial braking upon taxiing and turning.

The E/Z Brake works with 5/32" (.156") and 4mm landing gear with the following DU-BRO wheels:

Wheel Dia.	T	TL	SL	DL	R
2.25"	✓	✓	✓	✓	✓
2.50"	✓	✓	✓	✓	✓
2.75"	✓	✓	✓	✓	✓
3.00"	✓	✓	✓	✓	✓
3.25"	✓	✓	✓	✓	✓
3.50"	✓	✓	✓	✓	✓



No. 3370 E/Z Brake System (1 set/pkg.)

**(use on main wheels does require 2 sets.)*

STEERABLE NOSE GEAR

Quality, shock absorbing nose gear. 5/32" (4mm) heavy duty wire. Complete with nylon nose gear blocks, steering arm and all hardware. 1 set/pkg.

No. 152 (A) Bent (3 3/4" from center of coil to end)

No. 153 (B) Straight (6 5/8" from center of coil to end)

No. 154 Nose gear wire only - Straight

(6 5/8" from center of coil to end)

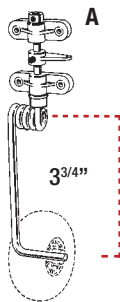

STEERING ARM ASSEMBLY

1-1/4" (31.7 mm) steering arm assembly. Nylon steering arm with brass bushing and set screw fits 5/32" (4mm) nose gear wire. Snap on E/Z Connector included. 1 set/pkg.

No. 155 Assembly **No. 166** Steering arm only

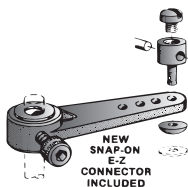

NICKEL PLATED DURA-COLLARS

Great for securely holding wheels on axles! Also great for many other uses. Enough stock so that threads will not strip & can be reworked for many other uses.

Allen Wrench Sizes (*):

1/16", 3/32", 1/8" = .050*

5/32", 3/16" = 1/16"* - 7/32", 1/4" = 5/64"*

No. 137 1/16" 1.5 mm 4/pkg.

No. 595 1/16" 1.5 mm 12/pkg.

No. 138 3/32" 2.3 mm 4/pkg.

No. 596 3/32" 2.3 mm 12/pkg.

No. 139 1/8" 3mm 4/pkg.

No. 597 1/8" 3mm 12/pkg.

No. 140 5/32" 4mm 4/pkg.

No. 598 5/32" 4mm 12/pkg.

No. 141 3/16" 4.7 mm 4/pkg.

No. 599 3/16" 4.7 mm 12/pkg.

No. 243 7/32" 5.5 mm 2/pkg.

No. 244 1/4" 6.3 mm 2/pkg.



No.'s 137 to 141 & No.'s 595 to 599 are packaged complete with Allen Wrench.

MICRO TAIL WHEEL BRACKET

Now your tail dragger can have a tail wheel bracket. The two piece bracket simply glues together to secure pre-bent 1/32 (.032) wire tail wheel strut. Ideal for use with DU-BRO Micro Tail Wheels.

No. 854 Micro Tail Wheel Bracket (.6 grams)

Wheel not included



MICRO TAIL WHEELS

You asked...we delivered! Our Micro Tail Wheels are available in two sizes, 3/8" & 1/2". Both sizes come complete with tail wheels (2), and Micro Wheel Retainers (4) per package. Axle dia. 0.031" on both tail wheels

No. 38MTW 3/8" Micro Tail Wheels w/ Retainers (.108" Wide)

No. 12MTW 1/2" Micro Tail Wheels w/ Retainers (.162" Wide)
(3/8": 0.2 grams ea. / 1/2": 0.4 grams ea.)

E/Z ADJUST AXLE

Zinc plated steel. Simply slide axle housing on 5/32" (4mm) nose gear or main wire and tighten with 8-32 set screw. The E/Z Adjust Axles are tightened with a 10-32 set screw. 2/pkg.

No. 615 2" x 5/32" (51mm x 4mm)

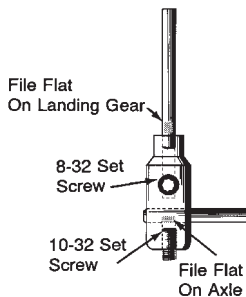

SPRING STEEL AXLE SHAFTS

Bolts to any dural landing gear. Easy installation. Available in four sizes. Comes complete with nylon insert lock nuts.

(length x diameter). Zinc Plated. 2/pkg.

No. 246 1-1/4" x 1/8" (32mm x 3mm) 1/4" hole

No. 247 1-1/4" x 5/32" (32mm x 4mm) 5/16" hole

No. 248 2" x 5/32" (51mm x 4mm) 5/16" hole

No. 249 2" x 3/16" (51mm x 4.7 mm) 5/16" hole

No. 250 3-3/8" x 1/4" (86mm x 6.35mm) 7/16" hole



NYLON GEAR BLOCKS

Includes two nylon blocks, four bolts, lock washers, nuts, one brass spacer. For 5/32" (4mm) wire. 1 set/pkg. No. 156

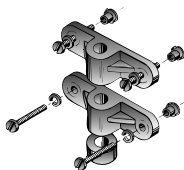

STEEL LANDING GEAR STRAPS

Zinc plated steel - light and strong. Includes (4) straps and (8) 2 x 7/16" slotted sheet metal screws. 4/pkg.

No. 158(A)

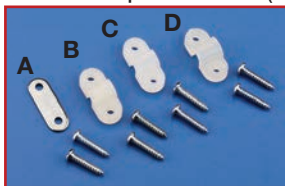

NYLON LANDING GEAR STRAPS

Strong nylon straps are molded to fit 1/8" (3mm) and 5/32" (4mm) music wire. Includes (4) straps and (8) 2 x 7/16" slotted sheet metal screws. 1 set/pkg.

No. 238(B) 1/8" (3mm) No. 239(C) 5/32" (4mm) No. 811(D) 3/16" (4.7mm)

TAILWHEEL BRACKETS

These tailwheel brackets are made of lightweight durable nylon. Available in three sizes to fit most airplanes from .40 size to large scale.

Includes 1 bracket, 1 wire form, 1 dura-collar and 3 flat washers. 1/pkg.

No. 375 for .40 size airplanes (1/16" axle dia. 1.5 mm)

No. 376 for .60 size airplanes (3/32" axle dia. 2.3 mm)

No. 377 for large scale airplanes (1/8" axle dia. 3mm)



MICRO TAIL SKID

Don't scratch your tail, our Micro Tail Skid comes with two pins molded on flat for easy installation and secure gluing. Keeps the tail section of your aircraft from getting scuffed up!

No. 853 Micro Tail Skid (.57 grams)



MICRO STEERABLE TAIL WHEEL

The Micro Steerable Tail Wheel comes with the strut and a 1/2" dia. wheel. This mount can be steerable or left free to travel. Mounts directly to the tail of your aircraft with CA (cyanoacrylate) or epoxy. The arm for steering is included and is 1 1/16" wide. This unit is paintable ABS plastic and will add functionality to your aircraft without adding a lot of weight.

No. 926 Micro Steerable Tail Wheel 1/pkg. (1.75 grams/ea.)



VINTAGE WHEELS

Our scale vintage wheels come in (5) sizes, 1/8 scale (3.50"), 1/6 scale (4.66"), 1/5 scale (5.60"), 1/4 scale (7") and 1/3 scale (9.33"). Each is made of lightweight solid foam material which is very durable. Internally, the tire is secured to the hub which is paintable ABS plastic.

No. 350V 1/8th Scale Vintage Wheels-2/pkg.	Axle Dia. 1/8"	(Weight: approx. 44 grams/ea tire)
	Can Drill to: 3/16"	(Hub Overall Width: 1.00")
No. 466V 1/6th Scale Vintage Wheels-2/pkg.	Axle Dia. 3/16"	(Weight: approx. 107 grams/ea tire)
	Can Drill to: 1/4"	(Hub Overall Width: 1.25")
No. 560V 1/5th Scale Vintage Wheels-2/pkg.	Axle Dia. 3/16"	(Weight: approx. 160 grams/ea tire)
	Can Drill to: 1/4"	(Hub Overall Width: 1.45")
No. 700V 1/4th Scale Vintage Wheels-2/pkg.	Axle Dia. 3/16"	(Weight: approx. 245 grams/ea tire)
	Can Drill to: 1/4"	(Hub Overall Width: 1.78")
No. 933V 1/3rd Scale Vintage Wheels-2/pkg.	Axle Dia. 1/4"	(Weight: approx. 667 grams/ea tire)
		(Hub Overall Width: 2.82")



1/4 Scale Balsa U.S.A. "S.P.A.D." shown with DU-BRO #700V Vintage Wheels
Aircraft Image Provided By: Balsa USA



MICRO WHEEL COLLARS

Lighten up with our Micro Wheel Collars. Designed for electric flyers with .047" to .062" axles and use set screws for a secure fit. These Micro Wheel Collars are **50% LIGHTER** than standard 1/16" brass wheel collars. Each collar weighs 0.42 grams. Each pack includes (4) collars with set screws and a .050" allen wrench. 4/pkg.

No. 944 1/16" (1.5mm) Micro Wheel Collars



MICRO SPORT WHEELS

These open spoke wheels will add a sporty look to your model and allow you to take off from grass fields. They also work well with indoor models. 2/pkg.

CAT. NO.	WHEEL DIA.	WHEEL WIDTH	AXLE DIA.	WEIGHT (ea/grams)
123MS	1.230" (31mm)	.270" (6.8mm)	.047" (1.2mm)	1.1
145MS	1.450" (37mm)	.300" (7.6mm)	.078" (2.0mm)	1.8
186MS	1.860" (47mm)	.345" (8.7mm)	.078" (2.0mm)	3.2
250MS	2.500" (63.5mm)	.396" (10.0mm)	.078" (2.0mm)	6.9
300MS	3.000" (76.2mm)	.508" (12.9mm)	.078" (2.0mm)	11

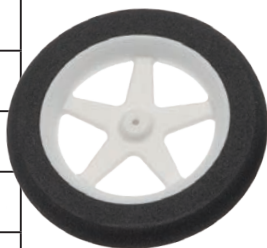

MINI LITE WHEELS

Ideal for indoor and park flyers. Our Mini Lite Wheels are lightweight and features a 2 piece press together hub and a super light foam tire. Comes standard with .047 axle hole and can be drilled out for larger diameter axles.



These Mini Lite Wheels are sure to give your airplane that scale look.

Available in 3 sizes:

1" (25mm),
1-1/4" (32mm) and
1-1/2" (38mm). 1pair/pkg.

100MW (25mm)
1" Mini Lite Wheels
(1.8 grams/pair) (.330" Wide)

125MW (32mm)
1-1/4" Mini Lite Wheels
(2.2 grams/pair) (.330" Wide)

150MW (38mm)
1-1/2" Mini Lite Wheels
(4.2 grams/pair) (.430" Wide)



MICRO LITE WHEELS

Our Micro Lite Wheels are available in 3 sizes: 1-1/2" (38mm), 2" (51mm) and 2-1/2" (64mm). They feature a one piece design, with polished spokes and flat black wheel (no O-rings to come off rim). Comes complete with 2 sets of wheel retainers, a wide axle hub for a true running wheel. Perfect for indoor and park flyers. 1 pair/pkg.

150ML (38mm) 1-1/2" Micro Lite Wheels (.032 axle hole) (2.9 grams/pair) (.120" Wide)

200ML (51mm) 2" Micro Lite Wheels (.032 axle hole) (4.3 grams/pair) (.130" Wide)

250ML (64mm) 2-1/2" Micro Lite Wheels (.032 axle hole) (5.5 grams/pair) (.135 Wide)



SUPER LITE XL WHEELS

The Super Lite XL are available in multiple diameters. These tires are very durable and are mounted on a molded hub that captures the tire to avoid any roll off of the hub. The smooth tread and rounded edge provide a great ride for your aircraft and the material they are made from offers low bounce and super lightweight!

Note: Axle dia. is 5/32" (4mm) that can be drilled out to 1/4" (7mm) if needed. 2/pkg.

CAT. NO.	WHEEL DIA.	WHEEL WIDTH	AXLE DIA.	WEIGHT (ea/grams)
400SLX	4.00" (101.6mm)	1.18" (30mm)	5/32" (4mm)	28.4
450SLX	4.50" (114.3mm)	1.18" (30mm)	5/32" (4mm)	42.5
500SLX	5.00" (127mm)	1.18" (30mm)	5/32" (4mm)	51
550SLX	5.50" (139.7mm)	1.18" (30mm)	5/32" (4mm)	56.7
600SLX	6.00" (152.4mm)	1.18" (30mm)	5/32" (4mm)	70.9

SUPER LITE WHEELS

By far the lightest wheels we have ever produced!

The Super Lite Wheel series feature a closed cell treaded foam wheel, with nylon hub. These wheels are ideal for electric, park flyers and lightweight gas models. Available in sizes: 1-3/4"

to 3". 1 pair/pkg.



	Diameter	Width	Axle Dia.	Weight
No. 175SL	1-3/4" (45mm)	0.6875" / 11/16" (17.5mm)	1/8" (3mm)	4.4 gr/ea.
No. 200SL	2" (51mm)	0.6875" / 11/16" (17.5mm)	1/8" (3mm)	6.3 gr/ea.
No. 225SL	2-1/4" (57mm)	0.7813" / 25/32" (19.8mm)	5/32" (4mm)	10 gr/ea.
No. 250SL	2-1/2" (64mm)	0.7813" / 25/32" (19.8mm)	5/32" (4mm)	11.5 gr/ea.
No. 275SL	2-3/4" (70mm)	0.9063" / 29/32" (23.0mm)	5/32" (4mm)	14.8 gr/ea.
No. 300SL	3" (76mm)	0.9063" / 29/32" (23.0mm)	5/32" (4mm)	16.8 gr/ea.



DIAMOND LITE WHEELS

Now you can give your model that scale look with our new Diamond Lite Wheels. Featuring our closed cell lightweight foam with nylon hub. These wheels are ideal for electric, park flyer and lightweight gas models.

Available in 3 sizes: 2-1/2" (64mm), 2-3/4" (70mm), and 3" (76mm). 1 pair/pkg.

	Diameter	Width	Axle Dia.	Weight
No. 250DL	2-1/2" (64mm)	0.7813" / 25/32" (19.8mm)	5/32" (4mm)	12.2 gr/ea.
No. 275DL	2-3/4" (70mm)	0.9063" / 29/32" (23.0mm)	5/32" (4mm)	13.9 gr/ea.
No. 300DL	3" (76mm)	0.9063" / 29/32" (23.0mm)	5/32" (4mm)	16.5 gr/ea.



SUPER SLIM LITE WHEELS

Super Slim Lite Wheels were designed for most ARF s that need larger dia. treaded wheels to taxi and take-off from grass fields. They are slim to fit onto short and small diameter axles.

The axle hole is (3.0 mm) 0.118" dia. and a width of (16.4 mm) 0.645". They are lightweight at 8.8 grams/ea for the 275SSL and 10.2 grams/ea for the 300SSL. These also have many more applications in school projects and various crafts. 2/pkg

	Diameter	Width	Axle Dia.	Weight
No. 275SSL	2-3/4" (70mm)	0.645" (16.4mm)	.118" (3mm)	8.8 gr/ea.
No. 300SSL	3" (76mm)	0.645" (16.4mm)	.118" (3mm)	10.2 gr/ea.



TREADED LIGHTWEIGHT WHEELS

After 3 years of research and development, we have produced the tire for the 21st Century. These wheels are lightweight, shock absorbing, fuel resistant and built extremely TUFF. Available in: 1-3/4" - 3-1/2" dia. 1pr./pkg.

	Diameter	Width	Axle Dia.	Weight
No. 175TL	1-3/4" (45mm)	.675" (17mm)	1/8" (3mm)	13 grams/ea.
No. 200TL	2" (51mm)	.710" (18mm)	1/8" (3mm)	15 grams/ea.
No. 225TL	2-1/4" (57mm)	.780" (20mm)	5/32" (4mm)	24 grams/ea.
No. 250TL	2-1/2" (64mm)	.820" (21mm)	5/32" (4mm)	31 grams/ea.
No. 275TL	2-3/4" (70mm)	.925" (24mm)	5/32" (4mm)	39 grams/ea.
No. 300TL	3" (76mm)	1.00" (25mm)	5/32" (4mm)	53 grams/ea.
No. 325TL	3-1/4" (83mm)	1.11" (28mm)	5/32" (4mm)	64 grams/ea.
No. 350TL	3-1/2" (89mm)	1.25" (32mm)	5/32" (4mm)	75 grams/ea.



Tested on Airplanes over 50 lbs.

TREADED LIGHTWEIGHT WHEELS FOR BIG AIRPLANES

Our Large Scale Treaded Lightweight wheels are substantially lighter than other aircraft wheels available. These lightweight wheels feature a foam interior yet have a tough and rugged exterior skin for durability - excellent for paved runways! Hubs come with 3/16" (5mm) axle dia. opening and can be drilled out to 1/4" (6.35mm). The 700TL & 800TL have a 1/4" (6.35mm) axle dia. and can be drilled out to 3/8" (9.54mm). 1/pkg.

	Diameter	Width	Weight
No. 400TL	4" (102mm)	1.150" (29.21mm)	(108 grams/wheel)
No. 450TL	4-1/2" (114mm)	1.325" (33.65mm)	(166 grams/wheel)
No. 500TL	5" (127mm)	1.500" (38.10mm)	(175 grams/wheel)
No. 550TL	5-1/2" (140mm)	1.700" (43.18mm)	(298 grams/wheel)
No. 600TL	6" (152mm)	1.850" (47.00mm)	(372 grams/wheel)
No. 700TL	7" (178mm)	2.076" (52.70mm)	(639 grams/wheel)
No. 800TL	8" (203mm)	2.450" (62.20mm)	(794 grams/wheel)



Hub Mounting Design eliminates the wheel collar and hub cap clearance hassle with the 338TLC model.

TREADED LIGHTWEIGHT CUB WHEELS

Add the realism & final detail to your J-3 Cub with Du-Bro's Treaded Lightweight Cub Wheels. These J-3 Cub wheels offer bolt together hubs & realistic looking "Cub" wheel covers. Available in three sizes, these lightweights feature a foam interior yet have a tough and rugged exterior skin for durability. 1 pr./pkg.

	Scale	Diameter	Axle Dia.	Weight	Width
No. 338TLC	1/5 Scale	3-3/8" Dia. (86mm)	3/16" Axle (4.7mm)	(83 grams/ea)	1.525" W
No. 425TLC	1/4 Scale	4-1/4" Dia. (108mm)	5/32" Axle (4mm)	(155 grams/ea)	2.00" W
No. 558TLC	1/3 Scale	5-5/8" Dia. (143mm)	3/16" Axle (4.7mm)	(384 grams/ea)	2.50" W

REPLACEMENT CUB CAPS

- No. 338CC 1/5 Scale Cub Caps with mounting screws 2/pkg.
- No. 425CC 1/4 Scale Cub Caps with mounting screws 2/pkg.
- No. 558CC 1/3 Scale Cub Caps with mounting screws 2/pkg.

BIG WHEELS

Smooth inflatable tires with positive seal air valves. Features two piece bolt together hubs and hub caps. Wheels can be inflated (or deflated) thru a tiny valve in the side of the tire. Axle dia. size 5/32" (4mm). 1pr./pkg.

	Diameter	Width	Weight
No. 400RV	4" (102mm)	1.50" (38mm)	(130 grams/wheel)
No. 450RV	4-1/2" (114mm)	1.65" (42mm)	(153 grams/wheel)
No. 500RV	5" (127mm)	1.95" (50mm)	(235 grams/wheel)
No. 550RV	5-1/2" (140mm)	2.23" (57mm)	(265 grams/wheel)
No. 600RV	6" (152mm)	2.43" (62mm)	(321 grams/wheel)



LARGE SCALE TREADED WHEELS

Our treaded wheels are narrower in width to fit inside wheel pants and retracts easier. Comes with 3/16" (5mm) axle dia. and can be drilled out to 1/4" (6mm) if desired. Comes complete with our positive seal air valves and inflator valves. 1 wheel/pkg.



	Diameter	Width	Weight
No. 375TV	3-3/4" (95mm)	1.160 (29.4mm)	117 grams/wheel
No. 400TV	4" (102mm)	1.175 (29.8mm)	138 grams/wheel
No. 450TV	4-1/2" (114mm)	1.375 (34.9mm)	180 grams/wheel
No. 500TV	5" (127mm)	1.500 (38.1mm)	243 grams/wheel
No. 550TV	5-1/2" (140mm)	1.750 (44.4mm)	282 grams/wheel
No. 600TV	6" (152mm)	1.900 (48.2mm)	367 grams/wheel



REPLACEMENT TIRE VALVES & TIRE INFLATOR

- No. 809 (A) Replacement Tire Valves (2/pkg.)
- No. 333 (B) Tire Inflator (1/pkg.)





Round

Treaded

R & T TIRES

Du-Bro's low bounce captive air wheels have flown on more airplanes over the years than any other wheels on the market! The wall thickness is consistent throughout the wheel giving you a balanced tire. Comes complete with a sporty nylon metallic hub. Works well on grass & paved runways. 1pr./pkg.

	Diameter	Width	Axle Dia.	Weight
No. 175 T or R	1-3/4" (45mm)	.675 (17mm)	1/8" Axle (3mm)	13 grams/wheel
No. 200 T or R	2" (51mm)	.750 (19mm)	1/8" Axle (3mm)	17 grams/wheel
No. 225 T or R	2-1/4" (57mm)	.775 (20mm)	5/32" Axle (4mm)	28 grams/wheel
No. 250 T or R	2-1/2" (64mm)	.875 (22mm)	5/32" Axle (4mm)	36 grams/wheel
No. 275 T or R	2-3/4" (70mm)	.900 (23mm)	5/32" Axle (4mm)	43 grams/wheel
No. 300 T or R	3" (76mm)	1.030 (26mm)	5/32" Axle (4mm)	58 grams/wheel
No. 325 T or R	3-1/4" (83mm)	1.150 (29mm)	5/32" Axle (4mm)	79 grams/wheel
No. 350 T or R	3"-1/2 (89mm)	1.250 (32mm)	5/32" Axle (4mm)	99 grams/wheel



CHROME TREADED WHEELS

DU-BRO's treaded low bounce captive air wheels have flown on more airplanes over the years than any other wheels on the market! The wall thickness is consistent throughout the wheel giving you a balanced tire. Comes complete with a sporty nylon 6-spoke metallic vintage hub with a chrome like shine. Works well on grass & paved runways. 2/pkg.

These also have many more applications in school projects and various crafts.

	Diameter	Width	Axle Dia.	Weight
No. 175TC	1-3/4" (45mm)	.675 (17mm)	1/8" Axle (3mm)	13 grams/wheel
No. 200TC	2" (51mm)	.750 (19mm)	1/8" Axle (3mm)	17 grams/wheel
No. 225TC	2-1/4" (57mm)	.775 (20mm)	5/32" Axle (4mm)	28 grams/wheel
No. 250TC	2-1/2" (64mm)	.875 (22mm)	5/32" Axle (4mm)	36 grams/wheel
No. 275TC	2-3/4" (70mm)	.900 (23mm)	5/32" Axle (4mm)	43 grams/wheel
No. 300TC	3" (76mm)	1.030 (26mm)	5/32" Axle (4mm)	58 grams/wheel
No. 325TC	3-1/4" (83mm)	1.150 (29mm)	5/32" Axle (4mm)	79 grams/wheel
No. 350TC	3"-1/2 (89mm)	1.250 (32mm)	5/32" Axle (4mm)	99 grams/wheel

TAILWHEELS

Du-Bro Tailwheels are sporty looking and have a machined, one piece aluminum hub. Available in six sizes. 1/pkg.



	Diameter	Axle Dia.	Weight	Width
No. 75TW	3/4" Dia. (19mm)	1/16" Axle (2mm)	3 grams/wheel	.367 (9.33 mm)
No. 100TW	1" Dia. (25mm)	3/32" Axle (2mm)	7 grams/wheel	.450 (11.4 mm)
No. 125TW	1-1/4" Dia. (32mm)	3/32" Axle (2mm)	13 grams/wheel	.520 (13.2 mm)
No. 150TW	1-1/2" Dia. (38mm)	1/8" Axle (3mm)	22 grams/wheel	.672 (17.0 mm)
No. 175TW	1-3/4" Dia. (45mm)	1/8" Axle (3mm)	30 grams/wheel	.674 (17.1 mm)
No. 200TW	2" Dia. (51mm)	1/8" Axle (3mm)	45 grams/wheel	.770 (19.6 mm)



Extended surface area replaced prop washer.



Securely tightens on propeller.

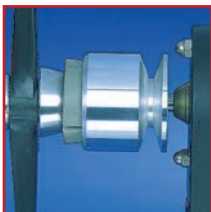

1-1/4" Diameter. Can be used with a standard starting cone.

SPINNER PROP NUTS

Our aluminum Prop Nuts weighs approximately one ounce, and are available in natural aluminum, or anodized in four colors. Our prop nuts work with standard electric starting cones, meet AMA safety specs. and are CNC machined from 6061 T6 aluminum.

Aluminum Spinner Prop Nuts

No. 730 1/4" - 28

No. 731 5/16" - 24

**Aluminum
Prop Nuts:**
1 oz.



DU-BRO Manufactures over 98% of our products in-house in our 40,000 sq. ft. facility in Illinois

- Simple, easy and safe to install (*no need to use the palm of your hand*).
- Available in 7 sizes.
- Each Spinner comes with 5 shaft adapters (5mm, 6mm, 1/4", 7mm, 5/16" shafts). *You don't have to drill out our back plates!*
- Features a unique nylon insert lock design for attaching the back plate and spinner - giving a solid and secure hold.
- Designed with safety in mind.

We Use
100% Virgin Nylon
For Max. Strength!



WHITE	BLACK	RED	YELLOW	BLUE	Metric Equiv.
260 1-1/2" Dia.	261 1-1/2" Dia.	262 1-1/2" Dia.	263 1-1/2" Dia.	264 1-1/2" Dia.	38mm
266 1-3/4" Dia.	267 1-3/4" Dia.	268 1-3/4" Dia.	269 1-3/4" Dia.	270 1-3/4" Dia.	45mm
272 2" Dia.	273 2" Dia.	274 2" Dia.	275 2" Dia.	276 2" Dia.	51mm
278 2-1/4" Dia.	279 2-1/4" Dia.	280 2-1/4" Dia.	281 2-1/4" Dia.	282 2-1/4" Dia.	57mm
284 2-1/2" Dia.	285 2-1/2" Dia.	286 2-1/2" Dia.	287 2-1/2" Dia.	288 2-1/2" Dia.	64mm
290 2-3/4" Dia.	291 2-3/4" Dia.	292 2-3/4" Dia.	293 2-3/4" Dia.	294 2-3/4" Dia.	70mm
296 3" Dia.	297 3" Dia.	298 3" Dia.	299 3" Dia.	295 3" Dia.	76mm

Designed with
Safety in Mind!

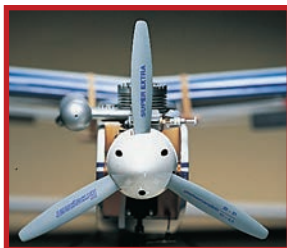
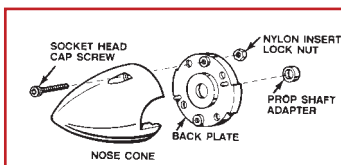

SPINNERS FOR THREE BLADE PROPS

- No. 541 2" (51mm) White
- No. 542 2" (51mm) Black
- No. 545 2-1/2" (64mm) White
- No. 546 2-1/2" (64mm) Black
- No. 549 3" (76mm) White
- No. 550 3" (76mm) Black

THE MODELERS #1 CHOICE IN SPINNERS

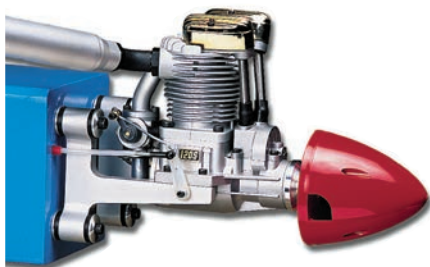

AN EFFECTIVE WAY TO REDUCE NOISE AND VIBRATION!

When purchasing a DU-BRO motor mount, it is best to understand its fundamentals. Our Motor Mounts are advanced in what they do, but remain simple in how they do it.

Vibration & harmonic resonance are by-products of your engine. In time, they can & will cause failure of something. It can show up in a broken hinge, a loosened clevis, fuel foaming, worn servo grommets, battery packs, receivers or even structural failure.

Du-Bro's innovative Motor Mounts are very effective in reducing airframe vibration & greatly reduce fatigue on the entire airframe. They are a totally captive mount that cannot debond & break free. Looking at the exploded view, the spool is solidly bolted to the firewall. The elastomeric rides on the spool & the sleeve which bears the engine & surrounds the elastomeric. The outer rib of the elastomeric absorbs the initial torque loads of the engine while the inner solid portion leaves plenty of compression to effectively absorb the power impulses - which causes most of the vibration in your aircraft. 1 pr./pkg.

- No. 658 Replacement Elastomeric Elements for No. 657 & 682
- No. 682 Motor Mount for .45 to .80 4-Stroke Engines
- No. 688 Motor MT. for 1.20 to 1.50 4-Stroke Eng. & 1.20 to 1.80 2-Cycle Eng.
- No. 689 Replacement Elastomeric Elements for No. 684, 686 & 688

DU-BRO's Shock Absorbing Design Reduces Airframe Vibration & Harmonics.

Cat.#	A	B	C	Wt. Grm
682	2-1/32"	2.700	4-13/64"	155
688	2-3/4"	3-17/32"	4.180	198

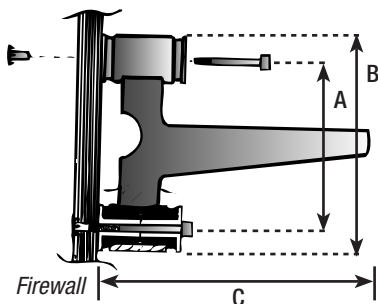

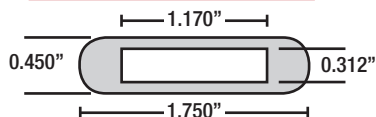
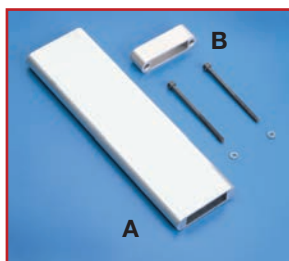

(Dimensions apply to #699 & #213)

MUFFLER EXTENSION

This muffler extension will fit the following .40 to .46 size engines - ASP™, Magnum™, O.S.® and Thunder Tiger™. Comes complete with two 3mm x 50mm screws. Dimension between screws is 1-7/16" 1/pkg. No. 699 (B) 1/2" Long

6" ALUMINUM EXHAUST EXTENSION

Custom make your own muffler extension. Will fit most engines .29 to .80 2-cycle & most mufflers. This stock can be cut, drilled, tapped and welded. 1/pkg. No. 213 (A)

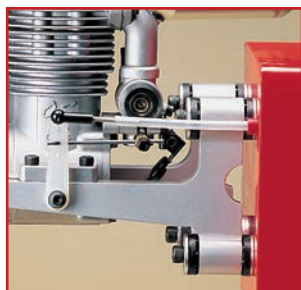

4-STROKE THROTTLE LINKAGE

DU-BRO's 4-Stroke Throttle Linkage eliminates the hassle of setting up a throttle linkage for 4-Stroke engines. This superior design leaves more room for linkage movement and is easy to install. Simply drill & tap a 4-40 hole into the side of your motor mount. A must for all 4-Stroke Engine installations. Ideal for 2-Cycle engines as well. 1/pkg. No. 665

BOLT ON PRESSURE FITTING

Includes brass pressure fitting, nut (#241 only) and fibre washer. Easily mounted anywhere on muffler by drilling a hole and bolting it or tap smaller hole. 1/pkg.

No. 241 6-32 (A) Recommend Tubing Size 1/8"

No. 539 8-32 (B) Recommend Tubing Size 5/32"

No. 540 10-32 (C) Recommend Tubing Size 5/32"





EXHAUST DEFLECTORS

Keep your aircraft clean! Install our silicone exhaust deflector on to your existing muffler and direct your engines exhaust oils and gases away from your model.

Our exhaust Deflectors mount to your muffler using the two (2) cable ties provided. This product will help to add years to your model's covering by simply directing the messy exhaust away from your aircraft.

No. 696 Exhaust Deflector (for .20 to .34 engines)
.360" I.D. Length 3"

No. 697 Exhaust Deflector (for .35 to .91 engines)
.415" I.D. Length 3"



Shown on underside of cowling.

**Don't take to the air,
track or water without the
DU-BRO Exhaust Deflector.**



Standard installation.

(A LETTER FROM A DU-BRO CUSTOMER)

Dear DU-BRO,
At The AMA Scale Nationals in August I met Ed Bojan who was enormously helpful to me during the competition. At one point Ed asked me what Du-Bro products I used in my scale model. I hadn't thought about it before, but it occurred to me that I probably have more Du-Bro components in the aircraft than those from any other manufacturer. I am using your fuel tank, tires, control system parts and countless hardware. I would guess that my competition T-34B is worth at least \$15,000, so I strive to use the best equipment, building materials, and parts.

Here are pictures of my Beechcraft T-34B taken at Top Gun in Florida and the Nats in Muncie Indiana. It is exact 1/4 scale and weighs 41 pounds.



Thank you,
Mark Frankel

SUPER BLUE SILICONE

For Glo-Fuel Only. Won't crack or harden and fits securely on fuel fitting.

No.	Size	Pkg.
196	Small (1/16" I.D.)	50 Ft. Spl.
197	Medium (3/32" I.D.)	50 Ft. Spl.
204	Large (1/8" I.D.)	30 Ft. Spl.
897	X-Large (5/32" I.D.)	25 Ft. Spl.
221	Small (1/16" I.D.)	2 Ft. Length
222	Medium (3/32" I.D.)	2 Ft. Length
223	Large (1/8" I.D.)	2 Ft. Length
553	X-Large (5/32" I.D.)	3 Ft. Length



Metric Equivalents:

1/16" = 1.5mm; 3/32" = 2.3mm

1/8" = 3mm; 5/32" = 4mm

TYGON FUEL TUBING (YELLOW)

If you're looking for a gasoline or diesel fuel tubing that won't harden or crack, but remains flexible, use tygon tubing.

No.	Size	Pkg.
505	Medium (3/32" I.D.)	50 Ft. Spl.
506	Large (1/8" I.D.)	30 Ft. Spl.
898	X-Large (5/32" I.D.)	25 Ft. Spl.
799	Med. (3/32" I.D.)	3 Ft. Length
800	Large (1/8" I.D.)	3 Ft. Length
554	X-Large (5/32" I.D.)	3 Ft. Length



3FT. SILICONE TUBING COMBO

Includes 1.5 Ft. blue Med. and 1.5 Ft. red Med. to distinguish your vent line and your carb line.

Cat. No. 892 (1.5 Ft. Blue / 1.5 Ft. Red Combo)



Everything in one package. (Silicone)

No. 680 3 Ft. Med. (3/32" I.D.) Fuel Tubing, Filter, Clips

No. 681 3 Ft. Lg. (1/8" I.D.) Fuel Tubing, Lg. Filter, Clips



FUEL LINE CLIPS

Fuel Line Clips help prevent fuel tubing from coming off fuel fittings. 4/pkg.

No. 677 For Med. Size Fuel Tubing (3/32" I.D.)

No. 678 For Lg. Size Fuel Tubing (1/8" I.D.)

KWIK-FILL FUEL CAP FITTING

Fill your tank with ease directly from your standard 1 gallon fuel container. Just drill or cut a 1/2" dia. hole in the cap and install the fitting as shown. Features a safety fuel line storage fitting to prevent leakage. Comes with filter pick-up.

Works with gas & glo fuel Cat. No. 807



US PAT. # 6,293,304B1

**STANDARD
& LARGE
SIZE**

E/Z FILL FUELING VALVE

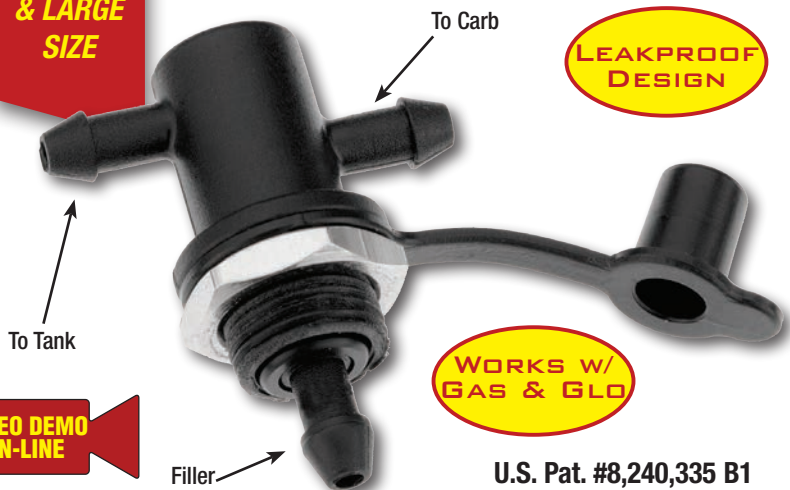

**VIDEO DEMO
ON-LINE**

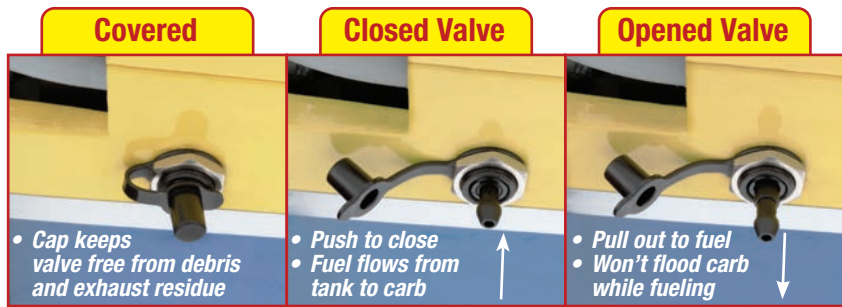

The E/Z Fill Fueling Valves make fueling and de-fueling your model easier than ever! Works with gas & glo fuel and the #996 accommodates medium - 3/32" ID fuel tubing while the #997 fits 1/8" & 5/32" fuel tubing. Generally fits models up to 1.20 size.

- No. 996 E/Z Fill Fueling Valve 1/pkg.
- No. 997 E/Z Fill Fueling Valve (Large) 1/pkg.



FUELING VALVE MOUNTING BRACKETS

The Fueling Valve Mounting Brackets make mounting your Fueling Valves a breeze. Using the included screws, the bracket will mount quickly and securely. Two sizes available.

- No. 994 Fueling Valve Mounting Bracket 1/pkg.
Fits Fueling Valves #334, 335, 996
- No. 995 Fueling Valve Mounting Bracket (Large) 1/pkg.
Fits Fueling Valves #610, 611, 997



E/Z Fill Fueling Valve shown on the Fueling Valve Mount (#994).



KWIK-FILL FUELING VALVE

The clean, safe way to fill your tank without disconnecting your fuel line from the carburetor. Perfect for models with enclosed engines. Easy to install. Comes complete with fueling probe. 1/pkg.

- No. 334(B) for Glo-Fuel
- No. 335(A) for Gasoline
- No. 339 Replacement Fueling Probe

LARGE SCALE FUELING VALVE

Du-Bro has taken innovation to its finest and produced a large scale fueling valve featuring a new press on dust cover to keep dirt and oil from getting into the valve.

Designed to work with 1/8" I.D. and 5/32" I.D. tubing, our new Large Scale Fueling Valve allows a higher volume of fuel to enter the carburetor and fill your fuel tank faster.

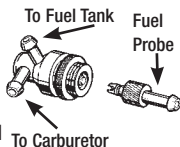

As larger airplanes are increasing in popularity, Du-Bro has again satisfied consumer demand for innovative products. Comes complete with fueling probe. 1/pkg.

- No. 610(C) For Glo-Fuel
- No. 611(D) For Gasoline
- No. 612 Replacement probe for Glo-Fuel and Gas



Dust Cover Keeps Dirt & Oil From Getting into Valve. (Cat. No. 610 & 611 Only)



REBUILD KIT

Comes complete with 2 o-rings, shuttle, spring, lock washer and nut.

- No. 718 Rebuild Kit for No. 334 Fueling Valve
- No. 719 Rebuild Kit for No. 335 Fueling Valve
- No. 720 Rebuild Kit for No. 610 Fueling Valve
- No. 721 Rebuild Kit for No. 611 Fueling Valve

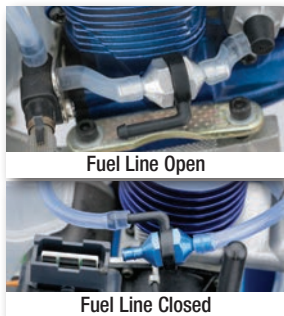

IN-LINE FUEL FILTERS W/ PLUG

Our In-Line Fuel Filters are constructed of two threaded aluminum parts which separate for easy cleaning. Includes a 130 micron mesh screen filter to filter out the smallest particles. The O-ring gasket will insure a proper seal against leakage. Plus, our In-Line Fuel Filter Plug is included to provide an easy method of "shutting off" the fuel source during transport. Simply remove the tank side of the fuel line from the filter and attach to the plug end and you're done. Use with 5/32" fuel lines.

- No. 340 (A) In-Line Fuel Filter w/ Plug
- No. 833 (B) In-Line Fuel Filter w/ Plug (Blue)
- No. 834 (C) In-Line Fuel Filter w/ Plug (Red)
- No. 835 (D) In-Line Fuel Filter w/ Plug (Purple)



LARGE SCALE IN-LINE FUEL FILTER (FOR GAS & GLO)

Constructed of two threaded aluminum parts which separate for ease in cleaning. Includes a 130 micron mesh screen filter to filter out the smallest particles and an o-ring to properly seal against leakage. Recommended to be used with 5/32" Fuel Lines. 1/pkg. No. 341 (C) Large Scale In-Line Fuel Filter

TANK FILTER

Combination weight and filter. Designed to fit all clunk tanks. Made of sintered bronze to give the ultimate in filtering. Recommended to be used with 5/32" Fuel Lines 1/pkg. No. 161 (D)

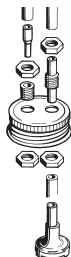

FUEL CAN CAP FITTINGS

For quick and easy fuel pump hook-ups. Universal cap fittings and new nylon filter for any standard 1-1/4" or larger. Includes 4-1/4" nuts, 3 top quality brass fittings and fuel filter. 1/pkg. No. 192

FUEL LINE PLUGS (FOR GAS & GLO)



Used to temporarily shut off fuel and air lines. Small plug is for 1/16" (1.5mm) and 3/32" (2.3mm) size tubing and the large plug is for 1/8" (3mm) and 5/32" (4mm) size tubing. Conveniently packaged with 2 small and 2 large size plugs. No. 617

REPLACEMENT FUEL TANK CAP & FITTINGS

Completely re-build your DU-BRO fuel tank with original DU-BRO components to insure a long, leak-proof life. Each kit includes the appropriate parts for either gasoline or glo-fuel applications.

Includes:

Cap, backing plate and screw, stopper, brass tubing and pick-up tubing.

No. 3360 (A) For 2oz. to 24oz. DU-BRO fuel tanks. (Glo-Fuel)

No. 3361 (A) For 32oz. to 100oz. DU-BRO fuel tanks. (Glo-Fuel)

No. 3362 (B) For 2oz. to 24oz. tanks. (Gasoline)

No. 3363 (B) For 32oz. to 100oz. tanks. (Gasoline)

(A) Silicone Tubing For Glo-Fuel

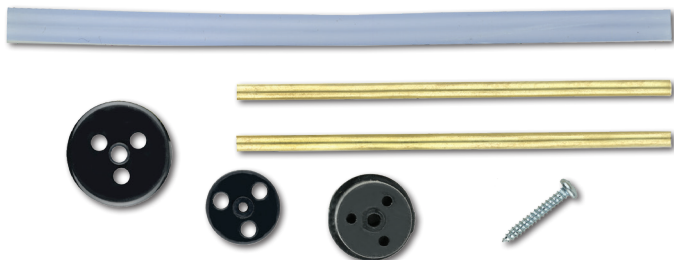

(B) Tygon Tubing For Gasoline

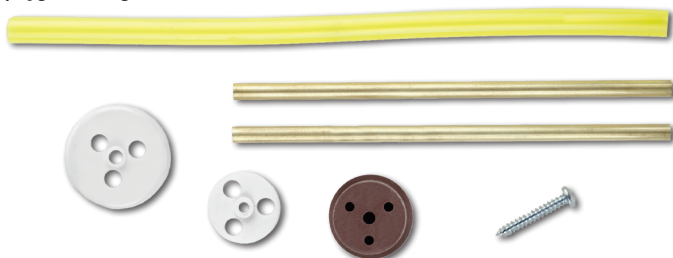

REPLACEMENT FUEL STOPPER

Specially formulated replacement stopper to convert any 2 oz. to 50 oz. Du-Bro fuel tank to gasoline. Replacement glo-fuel stopper also available.

No. 401(A) Glo-Fuel

No. 400(B) Gasoline

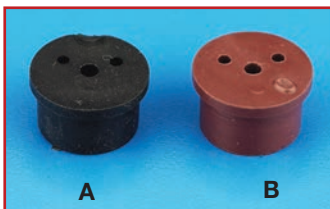



FUEL TANKS FROM 2 - 100 oz.

Filler cap fits over machined smooth neck of tank...Prevents tank from splitting...Forms a positive leakproof Seal.

Protruding front lip protects fuel lines from being crimped.
(6oz. - 100oz. only)

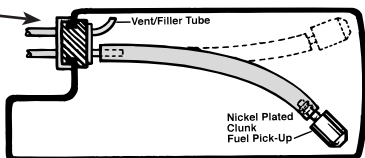

Du-Bro fuel tanks were designed with toughness in mind! Our fuel tanks will not split or crack from vibration or pressure. In fact, our fuel tanks can be used with pressurized fuel systems! Du-Bro fuel tanks come complete with all of the hardware including our one piece clunk with fuel barbs built right on the clunk stem, your fuel tubing will not slide off! Du-Bro fuel tanks can be used with either glo-fuel or gasoline if you purchase our Cat. No. 400 Gasoline Conversion Stopper. Next time you build a model, choose a Du-Bro fuel tank.

No.	Description	Size	Weight
No. 402	2 oz. (60 cc) Sq. Fuel Tank	1-5/16" H x 1-13/16" W x 2-3/4" Lg.	34 gr
No. 404	4 oz. (120 cc) Sq. Fuel Tank	1-1/2" H x 2-1/16" W x 3-3/4" Lg.	41 gr
No. 406	6 oz. (180 cc) Sq. Fuel Tank	1-7/8" H x 2-3/16" W x 3-7/8" Lg.	56 gr
No. 408	8 oz. (240 cc) Sq. Fuel Tank	1-15/16" H x 2-5/16" W x 4-7/8" Lg.	64 gr
No. 410	10 oz. (300 cc) Sq. Fuel Tank	2-1/4" H x 2-9/16" W x 4-7/8" Lg.	66 gr
No. 412	12 oz. (360 cc) Sq. Fuel Tank	2-1/4" H x 2-9/16" W x 5-3/8" Lg.	68 gr
No. 414	14 oz. (420 cc) Sq. Fuel Tank	2-3/8" H x 2-11/16" W x 5-3/8" Lg.	72 gr
No. 416	16 oz. (480 cc) Sq. Fuel Tank	2-3/8" H x 2-11/16" W x 5-7/8" Lg.	77 gr
No. 420	20 oz. (600 cc) Sq. Fuel Tank	2-1/2" H x 3-1/16" W x 7" Lg.	96 gr
No. 424	24 oz. (710 cc) Sq. Fuel Tank	2-1/2" H x 3-1/16" W x 7-1/2" Lg.	100 gr
No. 402-424 use 3/32" ID tubing			
No. 690-692 come complete with stopper & fuel tubing for both gas & glo-fuel and proportionally larger brass tubing and clunk. (32 oz.-100 oz. use 1/8" ID Tubing)			
No. 690	32 oz. (950 cc) Sq. Fuel Tank	3" H x 3-11/16" W x 7-3/4" Lg.	160 gr
No. 691	40 oz. (1200 cc) Sq. Fuel Tank	3-1/4" H x 4" W x 8" Lg.	178 gr
No. 692	50 oz. (1500 cc) Sq. Fuel Tank	3-1/2" H x 4-3/8" W x 8-3/8" Lg.	186 gr
No. 795	60 oz. (1800 cc) Sq. Fuel Tank	3-5/8" H x 4-1/2" W x 8-5/8" Lg.	182 gr
No. 796	80 oz. (2400 cc) Sq. Fuel Tank	3-5/8" H x 4-13/16" W x 10-1/2" Lg.	225 gr
No. 797	100 oz. (3000 cc) Sq. Fuel Tank	3-5/8" H x 5-1/4" W x 11-5/8" Lg.	240 gr

OVER 40 YEARS 0% FAILURE



FILL IT FUELING SYSTEM

Now, one fueling system that can be used with 4 different tubing sizes: 1/16", 3/32", 1/8" and 5/32" I.D. Ideal for cowlled engines, lightweight, no leaks, and can be used with glo-fuel or gasoline.

The Fill It Fueling System features The Fill It Plug with handy knob for easy removal of fuel line to fill or drain your fuel tank. Comes with housing, 4 Fill It fuel line plugs for different fuel tubing sizes, clunk and fuel tube for third line pick-up. No. 840

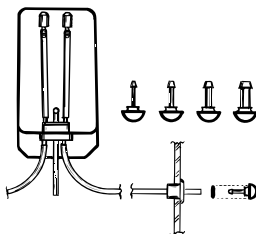

Fill It The Clean, Fast and Inexpensive Way!



Use knob to pull Fill It Plug and fuel tubing out.



Connect fuel nozzle to easily fill or drain fuel tank.



CLUNKS

Du-Bro Standard and Large Clunks are now available separately. Our Clunks are Nickel Plated to prevent corrosion. Fuel Line Barbs are machined right in Clunk to grip your fuel lines securely. 1/pkg.

No. 837 Standard (7.5 grams - .26 oz) Use 3/32" Tubing

No. 838 Large Clunk (13.6 grams - .48 oz) Use 5/32" Tubing

FUEL LINE BARBS

Help prevent fuel lines from coming off tubes inside and outside your fuel tank with our popular Fuel Line Barbs. Solder on installation.

Available in 1/8" and 5/32". 4/pkg.

No. 813 1/8" I.D. Fuel Line Barb

No. 814 5/32" I.D. Fuel Line Barb



Fillin' Station

When you fuel your aircraft with the Fillin' Station from DU-BRO, you will have everything you need right on board your bottle.



U.S. Pat. No. 6,293,304
and other U.S. Pat. Pend.

Fuel Can Version



INCLUDES:

1. **Kwik-Fill Fuel Pump**
Works with gas & glo-fuel.
2. **Kwik Fill Fuel Cap Fitting**
No leakage.
Aluminum fitting.
3. **Leak Proof Cap***
O-Ring seal.
4. **Silicone Fuel Tubing**
For glo-fuel only.
For gas, use DU-BRO Tygon Tubing #506 (sold separately)
5. **Built-In Tool Holders**
Keep screwdrivers, ball drivers, and other tools right on-board.
6. **Aluminum Glo-Plug Holders**
Holds (2) glo-plugs.
(Glo-plugs not included)

ALSO AVAILABLE WITH:

7. **Kwik Start Glo-Plug Ignitor**
Charger included.
8. **4-Way Wrench**
Works on American & Metric sizes: 5/16", 3/8", 7/16", 1/2", 8mm, 10mm, 11mm, 12mm.
Use No. 907 for complete version.

* Bottle version only.

No. 911



- No. 907 Fillin' Station (Complete Version)
- No. 908 Fillin' Station (w/o Kwik Start & 4-Way Wrench)
- No. 910 Fillin' Station Can Mount (w/o Kwik Start & 4-Way Wrench)
- No. 911 Kwik Fill Fuel Pump (Includes pump, silicone tubing, filter, pick-up, Kwik-Fill Fuel Cap Fitting and mounting chain)

**WORKS W/
GAS & GLO**

*Use Tygon Tubing for gas (not included).

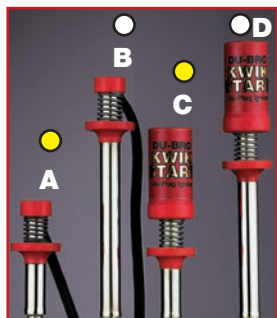

Length of reach from grip

● = 1 1/8" ○ = 2 7/8"



Du-Bro XL Glo-Plug Ignitors fit hard-to-reach areas such as airplane cowls, boats, cars helicopters.



Charger Only
No. 619

Du-Bro offers a wide variety of Glo-Plug Ignitors. No. 147 Kwik-Glo Engine Cord Set just presses on the glo-plug and comes with a 30" cord. Our Kwik-Klip II's No. 337 and No. 338 (XL) have a spring loaded grip and come with 30" cord. The Kwik-Start Glo-Plug Ignitors come complete with a Sanyo battery and a USB charger.

- No. 337 (A) Kwik-Klip II w/30" Cord
- No. 338 (B) Kwik-Klip II X-Long w/30" Cord
- No. 666 (C) Kwik-Start w/Battery, Charger & Storage Clip
- No. 841 (C) Kwik Start with battery only
- No. 668 (D) Kwik-Start X-Long w/Battery, Charger & Storage Clip
- No. 842 (D) Kwik Start XL with battery only.
- No. 619 (G) Charger Only



*Vertical
Glo-Plug
No. 794*



*Horizontal
Glo-Plug
No. 793*

REMOTE SAFETY IGNITOR

Safety first, safety all the time with the Remote Safety Ignitor. Removing the glo-plug ignitor from a started engine can be tricky and sometimes accidents do happen. We've eliminated that problem. Our Remote Safety Ignitor can be installed in five minutes and fits anywhere on the fuselage! Once the engine is started, the glo-plug can safely be removed without going near the prop. The small door is then shut to keep dirt and debris out of fuselage. Perfect for ARF flyers or anyone concerned about adding another safety factor to their aircraft.

- No. 793 Remote Safety Ignitor (Horizontal)
- No. 794 Remote Safety Ignitor for Recessed Glo-Plugs (Vertical)



TURNBUCKLES

Now there is no need to disconnect ball links to make front end adjustments! Get the ultimate in handling performance by replacing your stock linkage with DUBRO 4-40 Turnbuckles and quality built ball links. Precise toe-in, toe-out, and camber adjustments can be made with ease to get you back on the track fast! These 4-40 Turnbuckles are 2 5/8" long and can be cut to desired length.

No. 2156 4-40 Turnbuckles w/ Wrench 2/pkg.

No. 2157 4-40 Turnbuckles 2/pkg.

NITRO LINE FUEL TUBING

Nitro Line comes in 6 hot colors to add a great look to your vehicle. Our tubing is made from high quality silicone that is durable and will perform just the way it should. With no kinks when coiled and superb gripping on your fittings, Nitro Line is the real professional's choice. 50 foot spools also available. I.D. .080"



No. 2230 Nitro Line 2ft. (Yellow)

No. 2231 Nitro Line 2ft. (Green)

No. 2232 Nitro Line 2ft. (Orange)

No. 2233 Nitro Line 2ft. (Purple)

No. 2234 Nitro Line 2ft. (Red)

No. 2235 Nitro Line 2ft. (Blue)

No. 2238 Nitro Line 50ft. (Yellow)

No. 2239 Nitro Line 50ft. (Green)

No. 2240 Nitro Line 50ft. (Orange)

No. 2241 Nitro Line 50ft. (Purple)

No. 2242 Nitro Line 50ft. (Red)

No. 2243 Nitro Line 50ft. (Blue)





U.S. Pat.# US D500,536 S

**VIDEO DEMO
ON-LINE**

BODY KLIP RETAINERS

Our Body Klip Retainers are going to save you an enormous amount of time and frustration. Simple installation by making a small hole in the body, insert the retainer, and attach to your clips. Available in 9 cool colors (2/pkg.) and also includes a set of small clips and a set of large Body Klips. Drill Hole to 5/32"

- No. 2245 Body Klip Retainers (Black)
- No. 2246 Body Klip Retainers (White)
- No. 2247 Body Klip Retainers (Yellow)
- No. 2248 Body Klip Retainers (Red)
- No. 2249 Body Klip Retainers (Blue)
- No. 2250 Body Klip Retainers (Purple)
- No. 2251 Body Klip Retainers (Pink)
- No. 2252 Body Klip Retainers (Orange)
- No. 2253 Body Klip Retainers (Lime Green)

BODY KLIPS

- No. 2256 Body Klip (Small) 8/pkg.
- No. 2257 Body Klip (Large) 8/pkg.



A**SWIVEL
BALL LINKS****B****HEAVY DUTY
BALL LINKS****C****E/Z ADJUST
BALL LINKS****D****E/Z ADJUST
BALL LINKS****E****MONSTER
BALL LINKS**

DU-BRO Ball Links offer smooth friction-free operation with unsurpassed quality and durability.

	CAT. NO.	FITS ROD/ TURNBUCKLE	SCREW SIZE	PER PKG.
A	2133	2MM	2MM X 12MM	2
A	2135	2-56	2-56 X 1/2"	2
A	2139	4-40	2-56 X 1/2"	2
A	2160	4-40	4-40 X 5/8"	2
A	2161	4-40	4-40 X 5/8"	2

#2160 Does not include mounting hardware.

B	2262	4-40	4-40 X 5/8"	2
B	2263	4-40	4-40 X 5/8"	12
B	2321	3MM	3MM X 18	2
B	2322	3MM	3MM X 18	12
B	2266	6-32	4-40 X 5/8"	2
B	2267	6-32	4-40 X 5/8"	12
B	2268	6-32	6-32 X 5/8"	2
B	2269	6-32	6-32 X 5/8"	12

	CAT. NO.	FITS ROD/ TURNBUCKLE	SCREW SIZE	PER PKG.
C	2141	4-40	4-40 X 5/8"	2

D	2137	4-40	4-40 X 5/8"	2
----------	------	------	-------------	---

E	2317	4-40	4-40 X 5/8"	2
E	2318	4-40	4-40 X 5/8"	12
E	2319	3MM	3MM X 18	2
E	2320	3MM	3MM X 18	12
E	2315	6-32	6-32 X 5/8"	2
E	2316	6-32	6-32 X 5/8"	12

FOR EVEN MORE QUALITY DU-BRO BALL LINKS, GO TO PAGE #30





DU-BRO began in 1959 through the inventive imagination of Dewey Broberg. With a single product for igniting the glo-plugs on model airplanes (the original Kwik Klip), Dewey was quickly out-growing his modest production facility, a rented storage room in a factory. DU-BRO, a play on Dewey Broberg's name, was on the path to it's current 40,000 square foot manufacturing plant in Wauconda, Illinois.

For more than sixty years, DU-BRO has been synonymous with innovation, quality and American craftsmanship. The company continues to be the industry's leader in hardware and accessories. Plus, almost all of our products are still proudly **MADE IN THE USA** in our own factory!

While DU-BRO Products has been part of many advancements over the years, like the first radio control helicopter and one of the first ARF's in the 1970's, one thing has never changed; our appreciation for the modeler. Without the modeler's never ending thirst for new and creative products, DU-BRO's innovation would have been wasted. We know that we never could have succeeded without the loyalty and support of our customers. For over 60 years you have made us what we are!

From all of us at DU-BRO Products,
Thank you!

INTERNATIONAL SALES (EXCLUDING CANADA)

INTERNATIONAL HOBBYCRAFT CO.,INC.
NORTHBROOK,IL 60062-2502
U.S.A.

Telephone: +1 847 564 9945
Fax: +1 847 564 9951
Web: www.hobby-exporter.com
E-Mail- exports@hobby-exporter.com

Cat. No. 003



Printed in U.S.A.

DU-BRO PRODUCTS, INC.
P.O. Box 815 - 480 W.Bonner Rd.
Wauconda, IL 60084

Toll-Free (800) 848-9411
Ph. (847) 526-2136
Fax: (847) 526-1604
Website: www.dubro.com
E-Mail: rc@dubro.com