

Ronix[®]

Premium Quality

CORDLESS SPRAY GUN

8604



www.ronixtools.com

TECHNICAL SPECIFICATIONS

Model	8604
Voltage	20V
Battery Capacity	2000mAh
Paint Reservoir Volume	1200ml
Max. Viscosity	50-60din/sec
Max. Flow	600ml/min
Speed	32000RPM
Continuous Working Time	18-20 min
Battery Charging Time	60mins
LED Voltage	16-20V
LED Power	4W
Flux	150-200LM
CCT	7200-8000K
Weight	1.1kg
Supplied in	Ronix Color Box
Includes	clean needle, shoulder strap, viscosity cup, 2battery, charger, nozles (1/1.8/2.5mm), Spanner

PART LIST

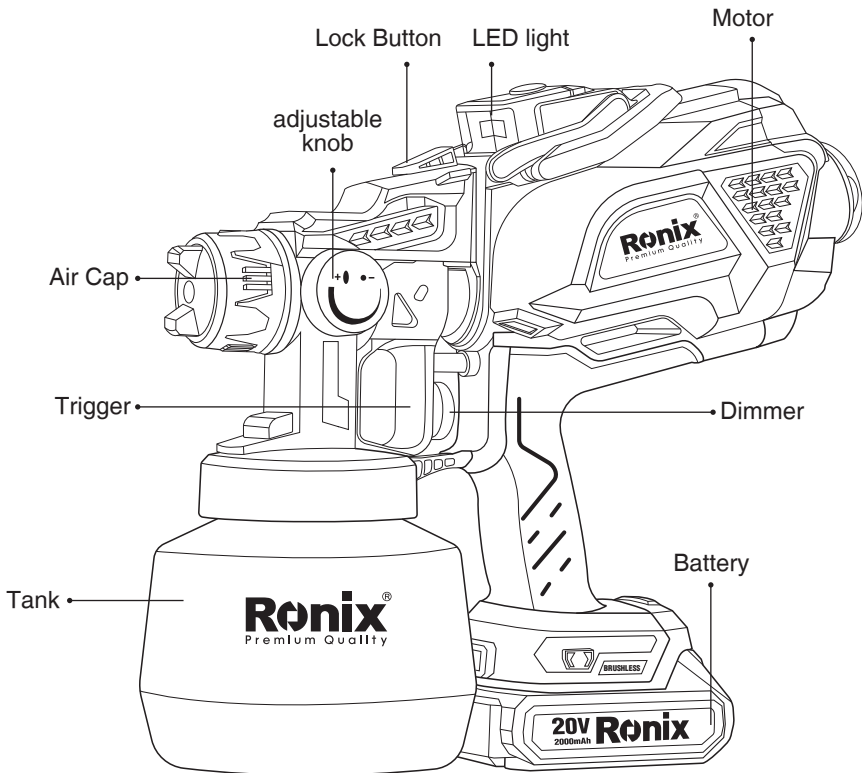

IMPORTANT SAFETY INFORMATION

■ READ AND FOLLOW ALL INSTRUCTIONS

Like other power tools, the PORTABLE SPRAY GUN is safe when properly used but can be dangerous if misused. It is the responsibility of the user to read and understand all instructions, and safety precautions before operating the unit and also to use the unit properly.

Failure to do so may result in personal injury or loss of life and product damage.

Do not try to repair (or disassemble) the unit yourself. Repairs

should be performed by Ronix Service Center.

When using parts that do not comply with the specifications and safety devices of the manufacturer, the user assumes all risks and liabilities.

WARNING!

- Do not spray flammable or combustible materials near an open flame, pilot lights or sources of ignition such as hot objects, cigarettes, motors, electrical equipment and electrical appliances.
- Keep area clean and free of paint or solvent containers, rags, and other flammable material
- Avoid creating sparks from connecting and disconnecting power cords.
- For use with only water-based with a minimum flash point of 73 °f(22c). (Flash point is the temperature at which a fluid can produce enough vapor to ignite)
- Always place the sprayer upright (do not place the sprayer upside down or on its side) to prevent liquid from entering internal wiring and causing electric shock.
- Keep spray area well ventilated. Keep a good supply of fresh air moving through the area.
- When you stop spraying, always unplug the cord to prevent unintended operation.
- Clean the spray gun thoroughly after each use.
- To prevent electrical shock, never immerse the sprayer into water or other liquids.

HOW TO USE

■ THINNING PAINTS

In order for your sprayer to operate properly it is important to make sure the paint is suitable to be sprayed.

- Hold the viscosity cup in your hand and block the bottom of the viscosity cup with one finger.

- Fill the viscosity cup with the diluted paint.
- Release your finger to let the paint leak and time it.
- Please refer to the thinning chart and picture.

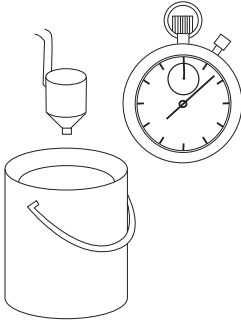

Material	Run out Time (Sec)
1) Oil enamel	25-60
2) Oil based primer	30-60
3) Oil stain	No thinning required
4) Clear sealer	No thinning required
5) Polyurethane	No thinning required
6) Varnish	20-60
7) Lacquer sanding sealer	25-35
8) Lacquer	25-35
9) Automotive finishes	20-40
10) Latex	45-90

■ CHOOSING THE PROPER NOZZLE

-The PORTABLE SPRAY GUN

can be equipped with 1.0mm/1.8mm/2.5mm nozzle.

The spray nozzle sets are changeable with the M4 wrench, simply turn the tip counterclockwise with the M4 wrench to loosen.

- Place the desired nozzle tip on the gun head and then tighten with M4 wrench.

- Fix the nozzle with air cap and big nut to complete the replacement. Please refer to the nozzle size and recommended paint in the table below.

Nozzle size	Recommend material	Project type
1.0mm	Sealers and varnish	Furniture and woodworking projects
1.8mm	Stains and polyurethane	Furniture and woodworking projects
2.5mm	Latex paint, chalk type paint, milk type paint	Furniture and cabinets

ASSEMBLY

- Make sure the container is empty and dry.

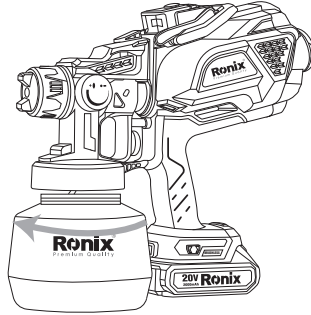

- Pour thinned paint into the tank, do not exceed the MAX. scale mark, rotate to tighten the tank.

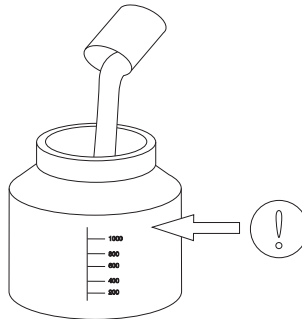

Be sure the suction tube is inserted tightly.

- a) If you are going to be spraying in a downward direction, the angled end of the suction tube should be pointing toward the front of the gun.
- b) If you are going to be spraying in an upward direction, the angled end of the suction tube should be pointing toward the rear of the gun.

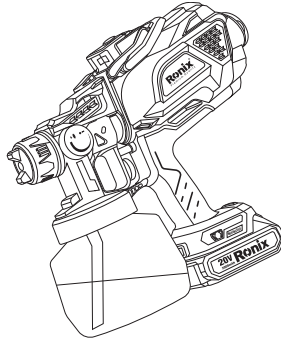

■ CONNECT GUN BODY WITH MOTOR

- a) Hold the gun with your hand to align the slot on the gun with the slot on the motor and insert it .
- b) Hold the motor handle with your hand, rotate the right hand clockwise 90°.
- c) When the gun and host are parallel, it is locked

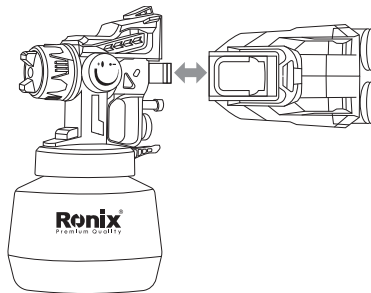

■ REMOVE THE MOTOR

- a. Hold the gun with your hand and press the latch in the direction of the arrow.
- b) At the same time hold the motor handle with your hand and rotate it counterclockwise 90°.
- c) Pull out to remove the motor from the gun.

■ REMOVE THE BATTERY PACK

- a. Hold the spray gun with your hand and press and hold the button on the battery (as shown in the figure).
- b. Pull out the battery

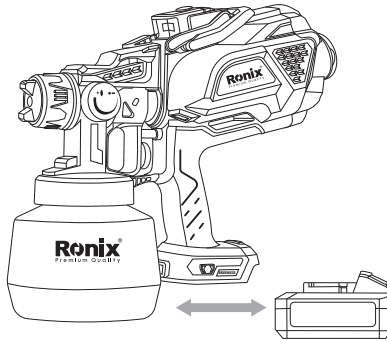

■ HOW TO USE LED LIGHTS

- a) Adjust the position of the LED light (as shown in the figure).
- b) Click the LED switch to turn on the LED light.

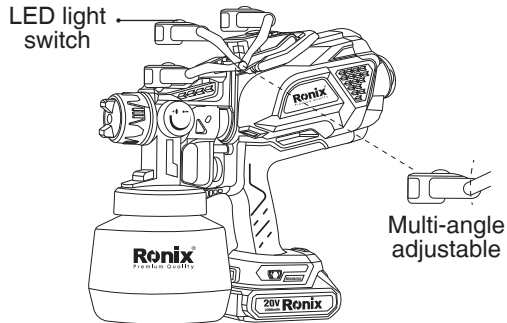

- c) When not in use, it can be detached and used as a work light.

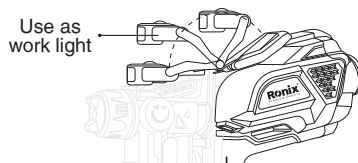

■ HOOK AND CARRYING

a) Shoulder strap can be hung on the hook and used on the shoulder

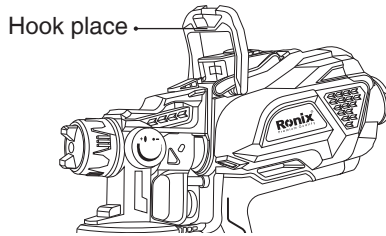

■ ACCESSORY BOX

a) First put the needle into the middle hole and fix it

b) Put the nozzle in the outer center

c) Put the wrench in the gap in the middle

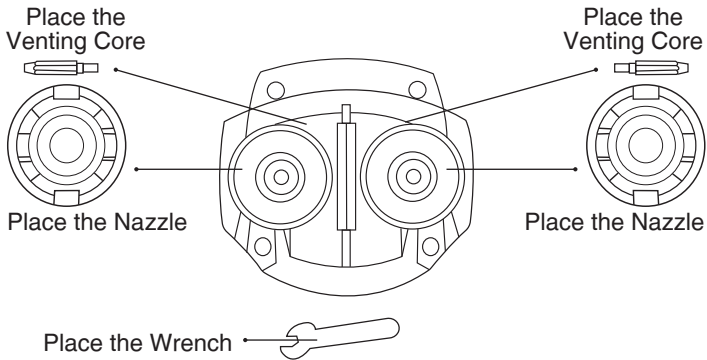

■ SPRAY INSTRUCTIONS

- Spray width adjustment

Patent spray width adjustment helps you control the spray width according to the spraying environment, reduce waste and save material.

a) The counterclockwise rotation shortens the width.

b) The clockwise rotation increased width.

c) By adjusting the air cap and the width knob at the same time, you will be able to spray a beautiful circular pattern.

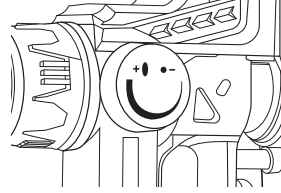
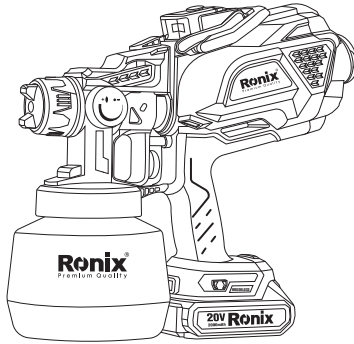

- Adjust the spray patterns

The spray pattern shape is adjusted by turning the ears of the air cap to either the vertical, horizontal, or diagonal positions. The positions of the air cap and the corresponding spray pattern shapes are illustrated below.

Test each pattern and use whichever pattern is suitable for your application

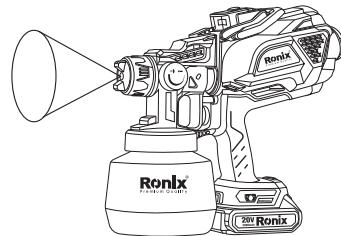
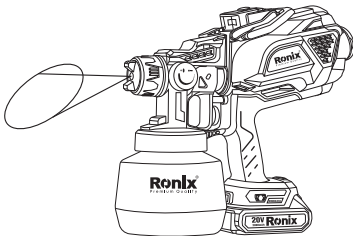

■ SPRAY PROPERLY

5.1. Keep distance.

The best distance for spraying is 8 to 12 inches from the surface you're spraying. Too far away may result in over spray (and wasted liquid), and too close may cause liquid build-up (runs).

- The spray result depends heavily on the smoothness and cleanliness of the surface to be sprayed. Therefore, the surface should be carefully prepared and kept free of dust.
- Cover all surfaces not to be sprayed.

- Cover screw threads or similar parts of the target object.
- It is advisable to test the spray gun on cardboard or a similar surface to find the correct setting.

⚠ IMPORTANT!

Begin spraying outside of the target area and avoid interruptions inside the target area.

⚠ CORRECT!

Be sure to hold the spray gun at an even distance of approx. 5 - 15 cm to the target object.

⚠ INCORRECT!

Heavy spray fog build-up, uneven surface quality.

- Move the spray gun evenly cross-wise or up-and-down, depending on the spray pattern setting.
- An even movement of the spray gun results in an even surface quality.

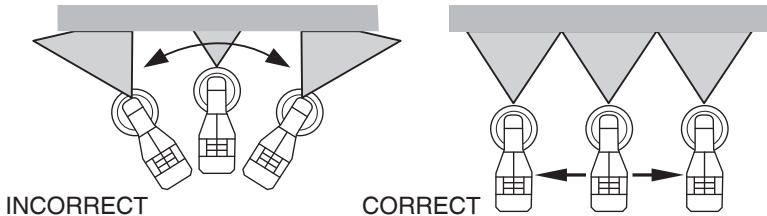

CLEAN UP AND MAINTENANCE

⚠ IMPORTANT!

Never store the sprayer longer than 30 minutes without cleaning.

Dried by-products act like glue and will cause moving parts to stick. Failure to properly clean your paint sprayer will damage the unit. Taking the time to clean your sprayer immediately after use will help your sprayer last longer and work correctly. If you are finished with the project or are not going to use the sprayer within the day, you must follow these instructions for proper clean up.

STEP ONE: Clean up the gun

- 1) Unplug sprayer from electrical outlet and pull trigger on spray gun so material inside unit flows back into the container.
- 2) Empty any remaining material from the container.
- 3) Fill container approximately 1/2 full with appropriate cleaning solution. For latex, use warm soapy water; for oil-based, use a cleaning solution recommended by the material manufacturer.
- 4) Plug sprayer into an electrical outlet.
- 5) Press the switch of the sprayer until the cleaning solution passes through the spray nozzle for several seconds.
- 6) Remove container and properly discard the cleaning solution.
- 7) Unplug the sprayer from the electrical outlet.

STEP TWO: Clean up the nozzle tip

- 1) Unscrew the container and discard any remaining cleaning solution.
- 2) Remove the suction tube from the sprayer and clean it with warm, soapy water.
- 3) Unscrew the air cap, remove the nozzle tips. Clean them with warm, soapy water.
- 4) Let the components dry thoroughly and reassemble the unit.
- 5) Store the unit.

TROUBLESHOOTING

Problem	Cause	Solution
A. little or no material flow	<ol style="list-style-type: none"> 1. nozzle clogged 2. suction tube clogged 3. material volume setting turn too far to the right 4. suction tube loose 5. material is too thick 6. inconsistent paint 7. container is loose 	<ol style="list-style-type: none"> 1. clean 2. clean 3. turn to the left 4. insert 5. check viscosity 6. strain paint 7. tighten the container
B. material leaking	<ol style="list-style-type: none"> 1. nozzle loose 2. nozzle worn 3. nozzle seal worn 4. material build-up on spray pattern dial and nozzle 	<ol style="list-style-type: none"> 1. tighten 2. replace 3. replace 4. clean
C. atomization is too coarse	<ol style="list-style-type: none"> 1. viscosity of material too high 2. material volume too large 3. nozzle clogged 4. too little pressure buildup in container 	<ol style="list-style-type: none"> 1. thin 2. turn to the right 3. clean 4. tighten container
D. too much over spray	<ol style="list-style-type: none"> 1. gun too far from spray object 2. too much material applied 	<ol style="list-style-type: none"> 1. reduce distance 2. turn material volume setting to right
E. pattern is very light and splotchy	<ol style="list-style-type: none"> 1. moving the spray gun too fast 	<ol style="list-style-type: none"> 1. adjust material flow or decrease movement of spray gun
F. large cloud of paint	<ol style="list-style-type: none"> 1. gun too close to surface 	<ol style="list-style-type: none"> 1. move gun away from surface and reduce paint flow

Ronix[®]
Premium Quality