

Ronix®

Premium Quality

ROTARY HAMMER 2703

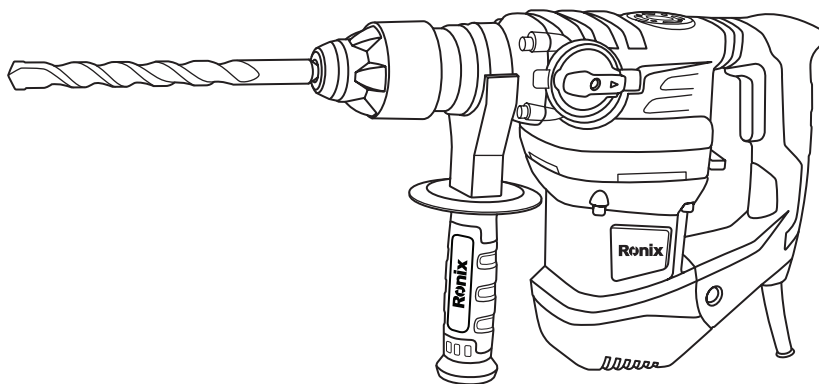

www.ronixtools.com

12
MONTHS
GUARANTY

FREE
DELIVERY

BANK
SPARE PARTS

CALL
CENTER
02161904

SPECIFICATIONS

SDS-Plus Chuck	Plus fitting
Chuck	32mm
Voltage	230V 50Hz
Reversible	No
Input power	1500w(approx.)
Impact hammer action	860r/min(approx.)
Weight	5.2 kgs(approx.)

WARNING!

The electric hammer chisel power tool noise output may exceed 85dB(A) at the workplace. In this instance, wear ear protection.



Wear safety-hearing protection



Wear Dust mask



Wear safety goggles



Wear safety shoes



Wear hard hat

KNOW YOUR ELECTRIC HAMMER

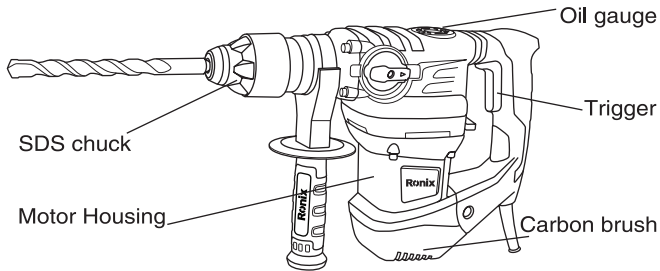

POWER TOOL SAFETY

■ GENERAL SAFETY RULES

▲ WARNING!

Read all instructions Failure to follow all instructions listed below may result in electric shock, fire and/or serious injury. The term “power tool” in all of the warnings listed below refers to your mains operated (corded) power tool or battery operated (cordless) power tool.

SAVE THESE INSTRUCTIONS

■ WORK AREA

Keep work area clean and well lit. Cluttered and dark areas invite accidents.

Do not operate power tools in explosive atmospheres, such as in the presence of flammable liquids, gases or dust. Power tools create sparks, which may ignite the dust or fumes.

Keep children and bystanders away while operating a power tool. Distractions can cause you to lose control.

■ ELECTRICAL SAFETY

Power tool plugs must match the outlet. Never modify the plug in any way. Do not use any adapter plugs with earthed (grounded) power tools. Unmodified plugs and matching outlets will reduce risk of electric shock.

Avoid body contact with earthed or grounded surfaces such as pipes, radiators, ranges and refrigerators. There is an increased risk of electric shock if your body is earthed or grounded.

Do not expose power tools to rain or wet conditions. Water entering the power tool will increase the risk of electric shock.

Do not abuse the cord. Never use the cord for carrying, pulling or unplugging the power tool. Keep cord away from heat, oil, sharp edges or moving parts. Damaged or entangled cords increase the risk of electric .

When operating a power tool outdoors, use an extension cord suitable for outdoor use. Use of a cord suitable for outdoor use reduces the risk of electric shock

■ PERSONAL SAFETY

Stay alert, watch what you are doing and use common sense when operating a power tool. Do not use a power tool while you are tired or under the influence of drugs, alcohol or medication. A moment of inattention while operating power tools may result in serious personal injury.

Use safety equipment. Always wear eye protection. Safety equipment such as dust mask, non-skid safety shoes, hardhat, or hearing protection used for appropriate conditions will reduce personal injury.

Avoid accidental starting. Ensure the switch is in the OFF position before plugging in. Carrying power tools with your finger on the switch or plugging in power tools that have the switch ON invites accidents.

Remove any adjusting key or wrench before turning the power tool on. A wrench or key left attached to a rotating part of the power tool may result in personal injury.

Do not overreach. Keep proper footing and balance at all times. This enables better control of the power tool in unexpected situations.

Dress properly. Do not wear loose clothing or jewellery. Keep your hair, clothing and gloves away from moving parts. Loose clothes, jewellery or long hair can be caught in moving parts.

If devices are provided for the connection of dust extraction and collection facilities, ensure these are connected and properly used. Use of these devices can reduce dust related hazards.

■ POWER TOOL USE AND CARE

Do not force the power tool. Use the correct power tool for your application. The correct power tool will do the job better and safer at the rate for which it was designed.

Do not use the tool if the switch does not turn it ON or OFF. Any power tool that cannot be controlled with the switch is dangerous and must be repaired.

Disconnect the plug from the power source before making any adjustments, changing accessories or storing power tools. Such preventive safety measures reduce the risk of starting the power tool accidentally.

Store idle power tools out of the reach of children and do not allow persons unfamiliar with the power tool or these instructions

to operate the power tool. Power tools are dangerous in the hands of untrained users.

Maintain power tools. Check for misalignment or binding of moving parts, breakage of parts and any other condition that may affect the power tools operation. If damaged, have the power tool repaired before use. Many accidents are caused by poorly maintained power tools.

Keep cutting tools sharp and clean. Properly maintained cutting tools with sharp cutting edges are less likely to bind and are easier to control.

Use the power tool, accessories and tool bits etc., in accordance with these instructions and in the manner intended for the particular type of power tool, taking into account the working conditions and the work to be performed. Use of the power tool for operations different from intended could result in a hazardous situation.

■ **SERVICE**

Tool service must be performed only by qualified personnel. Service or maintenance performed by unqualified personnel could result in risk of injury.

When servicing a tool, use only identical replacement parts. Follow instructions in the Maintenance section of this manual. Use of unauthorized parts or failure to follow Maintenance instructions may create a risk of electric shock or injury.

■ SPECIFIC SAFETY RULES

WARNING!

For your safety, do not plug in your Power tool until you have read and understood this Owner's Manual.

- WEAR EYE PROTECTION. Use face or dust mask along with safety goggles. Use hearing protection, particularly during extended periods of operation, wear safety shoes, wear hard hat.
- "Wear ear protectors with impact chisels. Exposure to noise can cause hearing loss"
- DO NOT wear gloves, jewellery, neckties or loose clothing.
- DO NOT drill, cut or sand material too small to be securely held.
- ALWAYS keep hands out of the path of the drill bit and saw blade. Avoid awkward hand positions where a sudden slip could cause your hand to move into the path of the drill bit or saw blade.
- SECURE WORKPIECE. Use clamps or a vice to hold the work when practical. It is safer than using your hand and it frees both hands to operate the tool.
- MAKE SURE there are no nails or foreign objects in the part of the workpiece to be cut drilled or sanded.

■ SPECIFIC SAFETY RULES – CONT'D

TO AVOID INJURY from accidental starting, always remove the Plug from the electrical socket before installing or removing a chisel bit.













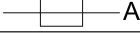
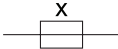

DRILL SAFETY

- When using electric hammer chisel only use bits that are configured with the correct slots for this chuck.
- BEFORE STARTING the operation, jog the chisel switch to make sure the chisel bit does not wobble or vibrate.
- DO NOT USE fly cutters or multiple-part hole cutters, as they can come apart or become unbalanced in use.
- MAKE SURE the spindle has come to a complete stop before touching the chuck or attempting to change the chisel bit also beware that the bit will be hot, let it cool down before changing as it could burn and cause injury.
- ALWAYS MAKE SURE THE CHISEL OR CHISEL IS FIRMLY SEATED IN THE Hex CHUCK before starting the job in hand.

SYMBOLS

Some of the following symbols may be used on your tool. Please study them and learn their meaning. Proper interpretation of these symbols will allow you to operate the tool better and safer.

V	volts
A	amperes
Hz	hertz
W	watt
Kw	kilowatts
F	farads
μF	microfarads
l	litres
Kg	kilograms
bar	bars

Pa	pascals
h	Hours
min	minutes
s	seconds
n_0	No load speed
./min or min^{-1}	Revolutions or reciprocations per minute
	direct current
	alternating current
2 	two-phase alternating current
$2N$ 	two-phase alternating current with neutral
3 	three-phase alternating current
$3N$ 	three-phase alternating current with neutral
	Rated current of the appropriate fuse-link in amperes
	Time-lag miniature fuseline where X is the symbol for the time/current characteristic, as given in EN 60127
	protective earthing at earthing terminal, Class I tools
\emptyset	Diameter
0	Off position
	Arrow
	Warning symbol
	alternating or direct current
	splash proof construction
	watertight construction
	class II construction
IPXX	IP symbol

ACCESSORIES & CARTON CONTENTS

■ AVAILABLE ACCESSORIES

WARNING!

Use only accessories recommended for this electric hammer chisel. Follow instructions that accompany accessories. Use of improper accessories may cause injury to the operator or damage to the cordless drill.

Do not use any accessory unless you have completely read the instructions or Owner's Manual for that accessory.

-Various chisels

CARTON CONTENTS

WARNING!

If any part is missing or damaged, do not plug the chisel into the power source until the missing or damaged part is replaced. Carefully unpack the tools see "Components chart" at right hand side of this page

NOTE:

See illustration of components on Page 10.

WARNING!

To avoid fire or toxic reaction, never use gasoline, naphtha, acetone, lacquer thinners or similar highly volatile solvents to clean the tool.

■ CARTON CONTENTS – CONT'D

ROTARY HAMMER		
KEY	Description	QTY
A	Rotary hammer	1
B	Chisels	2
C	Drill bits	3
D	Oil key	1
E	Carry case	1

ASSEMBLY & OPERATION

⚠ WARNING!

Always make sure the power tool is isolated from the power supply before fitting any attachment Handle.

Always make sure the fixed handle is secure before any job takes place as a loose handle could invite injuries.

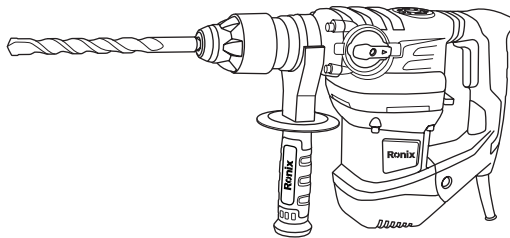

Switching the chisel on/off

The chisel has an On/Off switch built in to the handle. Holding the chisel with both hands simply squeeze the trigger and the motor will start. To switch off release the trigger.

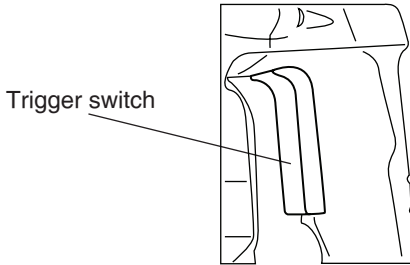

⚠ WARNING!

The electric hammer chisel continues for a few second after the trigger has been release, be careful when putting it down.
Fitting a chisel bit into the Hex housing.

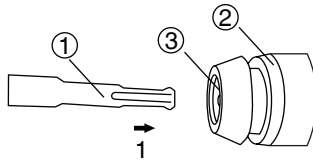

Put the bit into the hex housing and clamp the bit by turning the stop lever half a turn anti clockwise. This will lock the bit in place.

Do not use the chisel until you are satisfied the bit is secured.

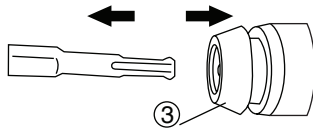

⚠ WARNING!

This electric hammer chisel does not have reverse direction, so always take care not to force the chisel in case the chisel bit gets stuck. Always make sure you keep the chisel going in and

out to remove debris.

This chisel does not have torque facility. It is not recommended to use any other bit other than masonry or chisels do not use metal cutting drills, this could cause serious injury.



NOTE:

chiseling for an extended period of time may cause the chisel motor to overheat. If the chisel gets hot, stop chiseling and allow it to cool for at least 15 minutes.

■ PRECAUTIONS ON USING ELECTRIC HAMMER CHISEL

- 1) Before using the electric hammer chisel always make sure the oil supply is to the full level and the screw is tight.
- 2) This electric hammer chisel has a fixed handle always make sure the screws holding the handle are secure before operation takes place. Always use both hands when using this chisel failure to adhere to this could invite injuries.
- 3) Safe operation, always make sure you have a stable posture and safe footing before operating the electric hammer chisel.
- 4) When working at a high level, always make sure that no person or persons are below you, as this could invite injuries to those persons under you.
- 5) Before starting any job like breaking, chipping a wall, floor or ceiling, thoroughly confirm that no items such as an electric cable, water pipe or conduit are buried inside as this could cause injury or flooding.
- 6) Properly set the bit holder.
- 7) The bit can become very hot during operation exercise extreme caution as this could cause injury.
- 8) Always wear protective safety glasses
- 9) Always wear ear defenders or earplugs

- 10) Always wear suitable dust mask
- 11) Always wear protective footwear.
- 12) Always wear hardhat

■ INFORMATION ON HOW TO USE THE ELECTRIC HAMMER CHISEL

Prior to operation

1) Power source

Ensure that the power source to be utilized conforms to the power requirements specified on the product nameplate.

2) Grounding

This tool should be grounded while in use to protect the operator from electric shock.

The tool is equipped with a three-conductor cord and grounding type receptacle, the green (or green and yellow) conductor in the cord is the grounding wire. Never connect the green (or green and yellow) wire to a live or neutral terminal.

3) Power switch

Ensure that the power switch is in the off position before any work is carried out on the chisel. If the plug is connected to a power receptacle while the power switch is in the on position, the power tool will start operating immediately this could invite serious injury.

4) Extension cord.

When the work area is away from the power source, use an extension cord of sufficient thickness and rated capacity. The extension cord should be kept as short as practicable.

■ HOW TO USE THE ELECTRIC HAMMER CHISEL

Place the bit you are going to use to do the job in hand as in page 10

- 1) Pull the trigger switch after applying the chisel bit tip to the chiseling position.
- 2) It may be necessary to punch the bit against the crushing position forcibly in order to begin the striking stroke. This is not due to malfunction of the tool, it means that the safe guard mechanism against no-load striking is working.
- 3) By utilizing the weight of the machine and by firmly holding the hammer chisel with both hands, one can effectively control the subsequent recoil motion.

Proceed at a moderate work rate, the use of too much force will impair efficiency.

⚠ CAUTION:

Sometimes the tool does not begin the striking stroke even when the motor rotates this may be because the oil has become thick Due to low temperature or has been standing idle for long period. Run the chisel for approx 5 minutes to bring the oil temperaturup.

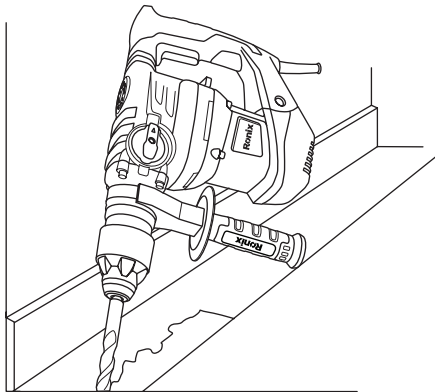

MAINTENANCE

■ OIL FEEDING

CAUTION:

Prior to oil feeding, always disconnect the plug from the power supply receptacle. Since an oil chamber is built in this electric hammer chisel, it can be used for approximately 20 days  without supplying lubrication oil, assuming that the chisel is used continuously 3 –4 hours daily.

Feed oil into the oil tank as described below before using the hammer chisel.

1) When the chisel is held upright look through the oil gauge window to see if oil is visible, if no oil shows oil must be installed before operating.

If chisel is used without oil this could seriously damaged the chisel and forfeit any warranty given.

2) Before feeding oil, use the provided wrench to remove the oil gauge (4). Be careful not to lose the rubber packing attached below the oil gauge.

3) Check the oil level once daily, confirming that oil is filled.

4) After feeding oil, securely clamp the oil gauge.

NOTE:

Oil for the electric hammer chisel is sold separately, use Shell oil ROTELLA 40 (engine oil) or equivalent, this is sold at most shops or filling stations anywhere.

■ MAINTENANCE AND INSPECTION

1) Inspecting the tool

When using dull tool bits this can cause motor malfunction and

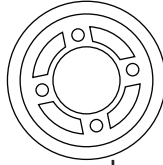

degraded efficiency. Always replace dull bits with new ones without delay when abrasion is noted.

2) Inspecting the mounting screws

Regularly inspect all mounting screws and ensure that they are properly tightened. Should any of the screws be loose, retighten them immediately. Failure to do so could result in serious injury.

3) Maintenance of the motor.

The motor unit winding is the very “heart” of the power tool. Exercise due care to ensure the winding does not become damaged and/or wet with oil or water.

4) Inspecting the carbon brushes.

The motor employs carbon brushes that are consumable parts; since an excessively worn carbon brush could result in motor trouble, replace the carbon brush. Wear limiter (6) No of carbon brush (7). (See Fig 7)

Always keep carbon brushes clean and ensure that they slide freely within the brush holders.

■ REPLACEMENT STEPS

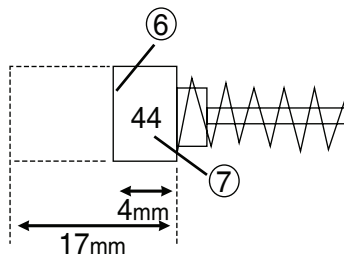

The carbon brush can be removed by removing the cap cover (9), cap rubber and brush cap in that order at the interior. To replace carbon brush reverse order of removal.

■ INSTALLING BITS

Never hold the chuck body with one hand and use the chisel power to the chisel body to loosen or tighten bits. You may severely injure your hand.

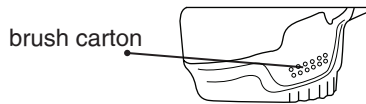

▲ WARNING!

Have you read “POWER TOOL SAFETY”, “DRILL SAFETY” and “SYMBOLS” on pages 4,5 & 6 of this manual? If not, please do it now before you operate this drill. Your safety depends on it! Every time you use the drill you should verify the following:

- 1) Hex bit is secure.
- 2) Oil level is full.
- 3) Select to the function you want to do before you engage in the proposed operation .
- 4) All safety apparel. Safety Glasses Safety Shoes. Safety Gloves. Ear Defenders and Safety Hat are being worn.

Failure to adhere to these safety rules can greatly increase the chances of injury.

▲ WARNING!

Be prepared for binding and bit breakthrough. When these situations occur, the chisel bit has the tendency to grab the workpiece.

This action will kick the chisel opposite to the direction of chisel bit rotation and could cause loss of control when breaking through

material as you complete chiseling the hole.

If you are not prepared, this loss of control can result in possible serious injury.

■ GENERAL

When servicing, use only identical replacement parts. Use of any other part may create a hazard or cause product damage.

DO NOT use solvents when cleaning plastic parts. Most plastics are susceptible to damage from various types of commercial solvents and may be damaged by their use. Use clean cloth to remove dirt, dust, oil, grease etc.

Do not at any time allow brake fluids, gasoline, petroleum-based products, penetrating oils, etc. to come in contact with plastic parts. They contain chemicals that can damage, weaken or destroy plastic.

DO NOT abuse power tools. Abusive practices can damage the tool as well as the workpiece.

DO NOT attempt to modify tools or create accessories not recommended. Any such alteration or modification is misuse and could result in a hazardous condition leading to possible serious injury. It will also void any warranty given.

PARTS LIST

When servicing, use only identical replacement parts. Use of any other parts may create HAZARD or cause damage to your power tool.

Any attempt to repair or replace electrical parts on this power tool may create a hazard unless repair is performed by a qualified technician.

NO	ENGLISH NAME	QTY	NO	ENGLISH NAME	QTY
1	Rubber Head	1	58	Washer 17.5*11.2*0.5	1
2	Steel Ring 17.5*2	1	59	Washer 18	1
3	steel frame	1	60	Button	1
4	Spring 30.2*1.8*76	1	61	Spring	1
5	Inner hexagon screw M5X22	4	62	Knob	1
6	Spring Washer 5	8	63	Spring Washer 4	1
7	Flat Washer 5	8	64	Flat Washer 4	1
8	Cylinder House	1	65	Cross Recess Head Screw M4X14	1
9	Oil Seal 35*51*6	1	66	Eccentric shaft	1
10	Big Washer 45*54.5*1	1	67	Bearing 6003	1
11	teleflex	1	68	Washer 34.5*28.5*1	1
12	Ball Φ 7.14	5	69	Washer	1
13	X-ring 20.9*2.2*4	1	70	Steel Ring 17	1
14	O-ring 11*2	3	71	Gear 27 Teeth	1
15	Impact hammer	1	72	Spring33*7.8*1.2	1
16	External retaining ring 35	1	73	Flat key 5*5*22	1
17	Bearing 61907-RZ	1	74	Pin 8*19	1
18	Ball Φ 7.938	3	75	Needle Bearing	1
19	Cylinder	1	76	Steel sleeve 26X22X9	1
20	Flat key 3*2.5*18	2	77	Oil Seal 35*51*6	1
21	Ring 45*55*7	1	78	Small gear	1
22	Washer38*47*1.5	1	79	Washer 15*19*4.7	1
23	Spring 42*2*28	1	80	Bearing 6002	1
24	Plastic sleeve	1	81	Washer 14.1*19*0.5	1
25	Chisel lock distance Sleeve	1	82	Gear 39 Teeth	1
26	Spring34*2.5*50	1	83	Ball 5	8
27	Clutch	1	84	Fixed plate	1
28	Gamp gear	1	85	Steel Ring	1
29	O-ring 28*1.8	1	86	Active plate	1
30	Hammer 25*30	1	87	Spring 14.2*9*0.5*2.7	4
31	O-ring 19*3.1	2	88	Nut M10*0.75	1
32	Piston Pin 6*24	1	89	Bearing 627	1
33	Piston 25*27	1	90	Twisting for Hammer	1
34	Connecting Rod	1	91	Pin	1
35	Steel bushing 12*10*8	1	92	Inner cover	1
36	Internal retaining ring 47	1	93	Bearing 6001	1
37	Bearing 30*47*9	1	94	Rotor	1
38	Oil Cover	1	95	Bearing 608	1
39	O-ring 31.5*2	1	96	Fan Guide	1
40	Gear Box	1	97	Screw ST3.9*60	2
41	Anti-vibration Holder	1	98	Stator	1
42	Anti-vibration Spring 10.5*1.4*35	2	99	E-rings	2
43	Anti-vibration Board	1	100	Motor Shell	1
44	Anti-vibration Screw M8*15	2	101	Inner hexagon screw M5X55	4
45	Cross pan head self-drilling screw	11	102	Brush	2
46	Right Handle	1	103	Brush Holder	2
47	Switch	1	104	Brush cover	2
48	Nut M8	1	105	Rubber-column	2
49	Electric capacity	1	106	Back cover	1
50	Electrical inductance	1	107	Oil baffle plate	1
51	Cable Board	1	S-1	T-Shape Screw M8*50	1
52	Cable sheath	1	S-2	Bracket	1
53	Cable 2*1mm ²	1	S-3	Auxiliary handle	1
54	Left Handle	1	S-4	Hoop	1
55	Inner hexagon screw M8*45	1			
56	Variable switch	1			
57	Dial Twist	1			

Ronix[®]
Premium Quality

www-ronixtools-com