

SINK DETAIL

Flow Rate: 8.42sec/gal

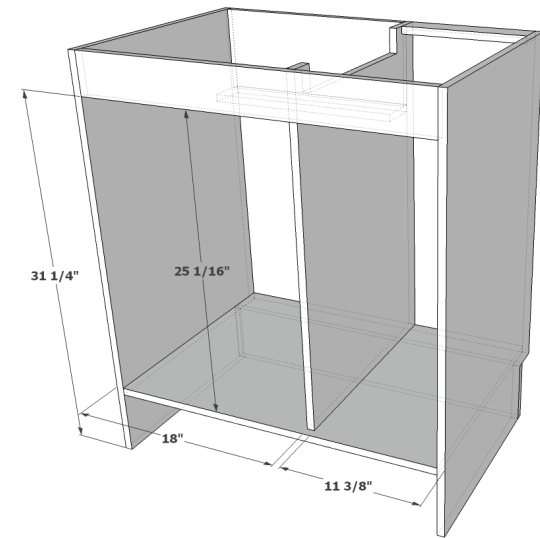

BACK DETAIL

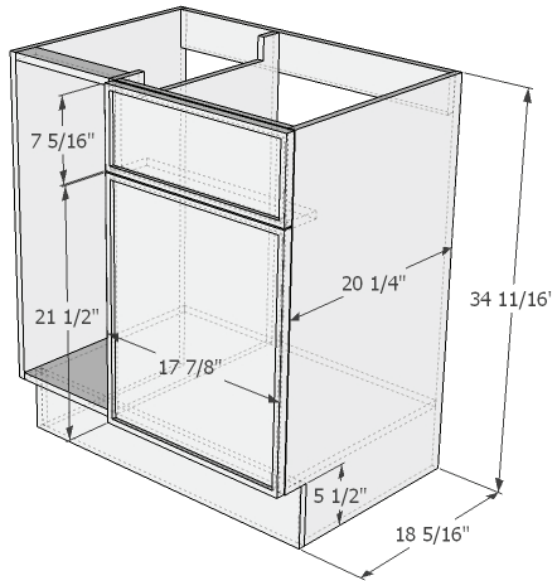
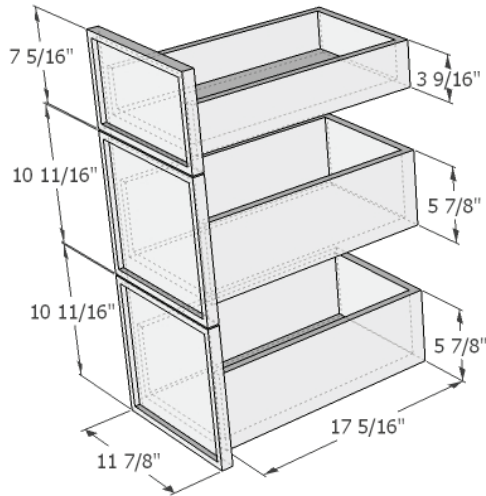

COLLECTION NAME

MANHATTAN COLLECTION

DISCLAIMER

ALL INFORMATION CONTAINED IN THIS DOCUMENT IS CONFIDENTIAL AND SHALL NOT BE REPRODUCED OR DIVULGED, IN WHOLE OR IN PART. DIMENSIONS ON FINISHED VANITIES MAY VARY SLIGHTLY FROM THOSE SHOWN ON THESE SPECIFICATIONS DUE TO VARIABILITY IN CONSTRUCTION MATERIALS.

CUTLER KITCHEN & BATH

81 ROYAL GROUP CRESCENT UNIT A VAUGHAN ONTARIO CANADA L4H 1X9 (tel) 905.212.121 (fax) 905.238.5512

VANITY STYLE

FREE STANDING

PRODUCT CODE

MAN%30

DESCRIPTION

30" Manhattan Collection - 1 Door 3 Drawers

CABINET SIZE

30" WIDE x 34 11/16" HIGH x 21" DEEP

AUTH. BY

SHANE

DATE

2020-09-09

REVISION #

1

PAGE #

1 OF 1