



**InströTek<sup>®</sup>  
Inc.**

innovators in instrumentation technology

**SMARTRACKER<sup>™</sup>**

Hamburg Wheel Tracker



# OPERATING MANUAL

[www.InströTek.com](http://www.InströTek.com)



# **SmarTracker<sup>™</sup>**

**Wheel Tracker Device for Measuring  
Rutting in Asphalt Mixtures  
Based on AASHTO T324**

Rev 6, Copyright June 2016



Innovators in Instrumentation Technology



# IMPORTANT

## **PRECAUTIONS WHEN USING THE SmarTracker**

1. DO NOT attempt any repairs on the unit with the power switch on.
2. DISCONNECT the unit from wall power before attempting any repairs.
3. Wipe off any water from the surface of the unit and from the surfaces surrounding the device to prevent shock.
4. Follow all your other related facility safety instructions while operating this device.
5. DO NOT operate this device without prior training.
6. Maintenance on this device must be done by trained technicians.
7. Call InstroTek, Inc. (919- 875-8371) if you have any questions.

# IMPORTANT



<b>Table of Contents</b>	<b>Page</b>
Introduction	1
System Location	1
System Specifications	2
Machine Components	2
System Setup	2
Main Menu	3
Running the Test	5
Specimen Preparation	5
Preheating Water	6
Inserting Specimen Tray into Waterbath	8
Test Setup	9
Performing the Test	13
Results	15
Clean Up	17
Data Storage and Printing	18
Alarms	19
Manually Position Loading Arm	21
Test Archives	23
System Configuration and Calibration	23
Control Panel	23
Maintenance	25
Warranty	29





# **Introduction**

InstroTek SmarTracker is designed for measuring the rut depth of asphalt mixtures in either water or air by following the procedures detailed in the AASHTO T324 standard. The rut depth profile from the SmarTracker can be used to predict the rutting performance and sensitivity to moisture damage of asphalt mixtures. The SmarTracker measures the rut depth over the length of the specimen for each pass using a measurement system that includes a high accuracy LVDT system for the rut depth and an encoder for the displacement across the specimen.

The System is fully automated with a microprocessor controlling the temperature, movement of the loading arms, and measurement acquisition. All the functions of the SmarTracker system are automatically controlled and the results are displayed on the touch screen.

## **System Location**

When setting up this unit, please select a location that meets the minimum requirements below.

1. Provide adequate space for the user to open the lid and insert/remove specimen trays. Also, provide adequate space for the unit to be rolled forward for service
2. Set the unit on a level and stable surface. It is recommended that the unit be leveled using the attached metal feet.
3. Use a dedicated AC circuit for powering the unit.
4. Location to drain water from the unit.

**NOTE:** The unit has an unplumbed overflow pipe in addition to the tank drains. If the water level gets too full due to water that is displaced when putting the specimen trays in a full water bath or the water inlet valve sticks open, water may come down this pipe and spill onto the floor.

# System Specifications

Temperature\* – Room temperature to 70°C

Dimensions – 54" W x 48" L x 50" H

Weight – 1450 lbs.

Wheel Speed\* – 30-55 passes per minute

Electrical Supply – Single Phase 208-230V – 30 Amps

Wheel Load\* – 705 +/- 4.5 N (158 +/- 1.0 lbf)

Displacement measurements\* – 0-25 mm +/- 0.1 mm

Water Capacity – 110 liters (30 US Gallons)

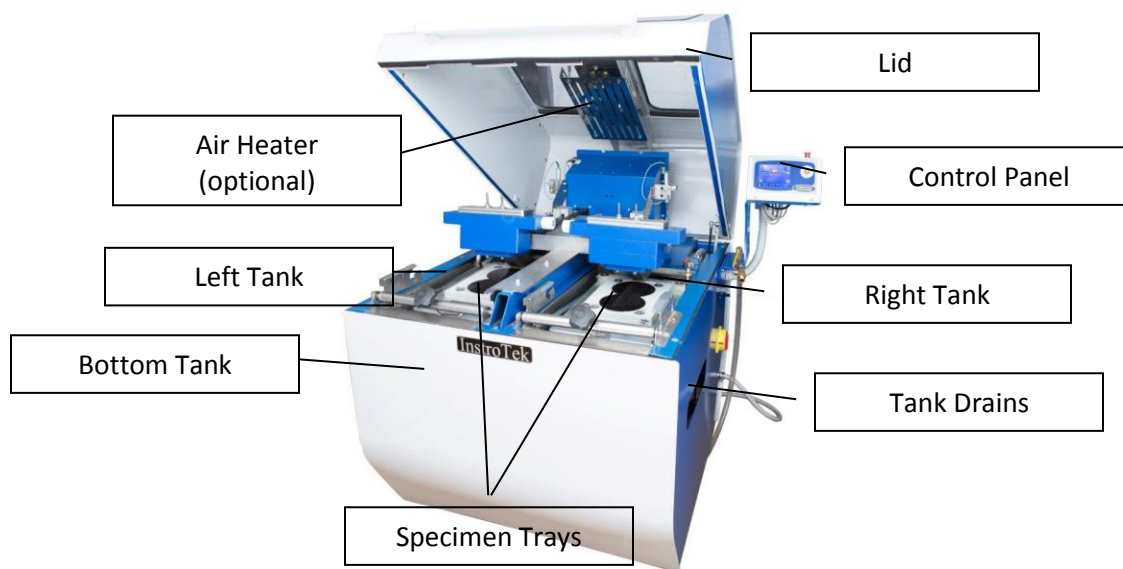

\*Meets or exceeds AASHTO T324 requirements

## MACHINE COMPONENTS



## System Setup

The following steps will guide you through the required connections for powering up the unit:





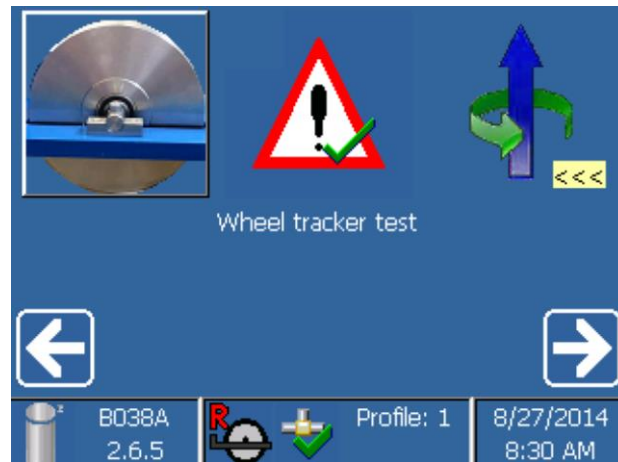

1. Plug the power cord in the appropriately rated outlet (30A – 230VAC).
2. Connect the unit to a clean water supply (minimal mineral content).
3. Turn ON the main power switch and the switch on the back of the touch screen.
4. The unit will perform a self-test and will show  when ready. If an alarm, , is shown, please refer the *Alarms* section.



# Main Menu



The main menu allows the user to select the main functions of the machine.



The main functions are:

-  Wheel Tracker Test
-  Active alarms
-  Manually position loading arm (<<< left wheel; right wheel >>>)
-  Washing tanks with supply water
-  Test archive
-  System configuration
-  Control panel

**Select an item with the touch-screen:** Scroll through the menu ( or ) until the desired menu item is highlighted and select the item by touching the screen.

**Select an item with the keyboard:** Scroll through the menu using the arrow keys (  or  ) until the desired menu is highlighted. Push the Enter key (  ) to select the item.

## STATUS BAR

The bottom of the main screen contains the status bar. The left side of the status bar provides the current software version installed on the machine. The center of the bar provides the current status of the machine. The right side provides the current date and time.

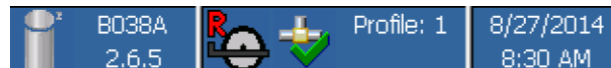

: Machine is ready to test



: Heating the air and water



: Running the test (automatic)



: Warning



## Running the Test

This section will provide a general guide to set up, run, and record the data for a test on the SmarTracker.

### SPECIMEN PREPARATION

1. Prepare specimens according to the instructions in the standard (AASHTO 324 or local state agency requirements).

**NOTE:** Specimens can be prepared using the gyratory compactor, kneading compactor, cores cut from the field, or slabs from a segmented laboratory roller compactor.

2. Cut the samples with a wet saw using a specimen mold as a cutting guide. See the figure below for details.

**NOTE:** An extra specimen mold is provided with the machine for a cutting guide.

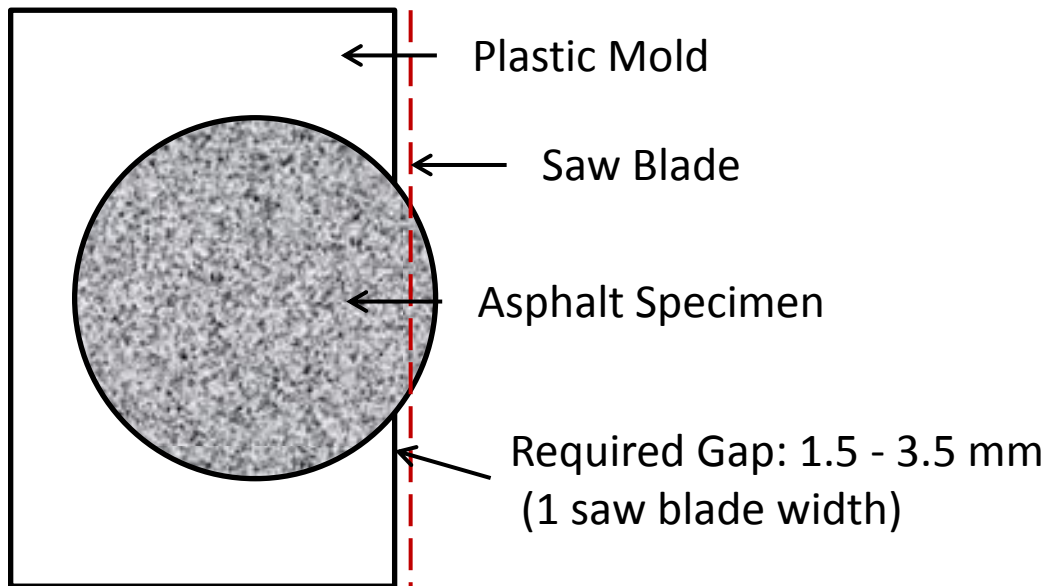

3. Tighten the specimens in the molds in the tray.
  - a. Insert the specimens in the molds.
  - b. Tighten the nut for each bolt 2-3 turns to apply even pressure to the confining plate; alternate between the left and right bolts until the confining plate is hand tight.
  - c. Tighten the *bolts* a quarter turn with a 13 mm wrench while holding the nut with your fingers; alternate sides until the bolts are tight. When the nut spins through your fingers, the nuts are tight enough for testing.

**NOTE:** The confining plate and specimen molds should not bend or bow during tightening. If this occurs, the tray has been overtightened. Loosen the bolts and repeat Step 3.

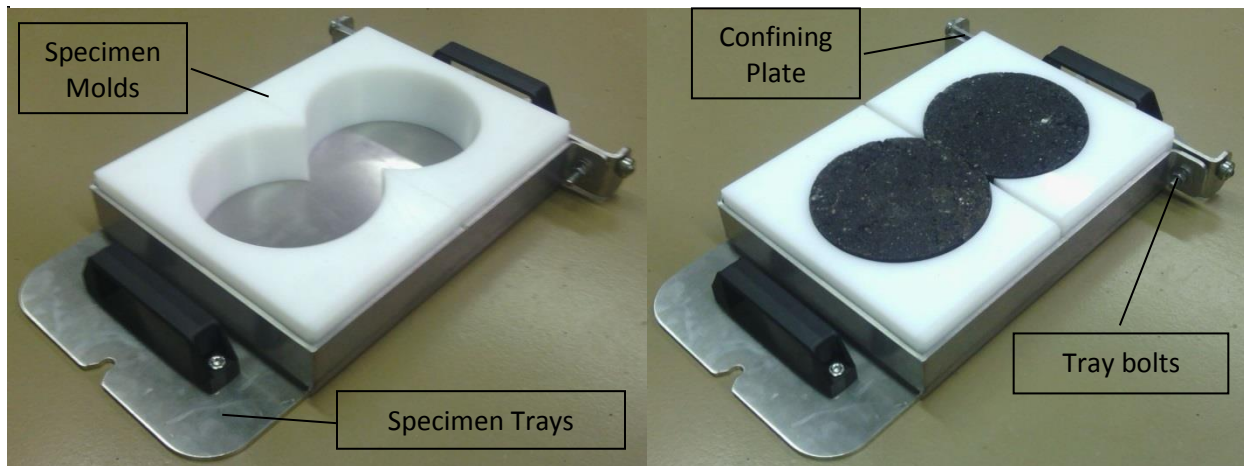

**NOTE:** The molds included with the SmarTracker are designed for 150 mm (nominally 6") gyratory specimens. Optional molds are available for field cores with a 145 mm diameter (from 6" outside diameter drill bits).

## PREHEATING WATER

The AASHTO T324 standard requires that the specimens be in the water at least 30 minutes to ensure the specimens are at the test temperature but not longer than 60 minutes to prevent unnecessary aging of the specimens. It is recommended to use a hot water source to fill the water bath. If this is not feasible, a procedure has been developed to preheat the water before inserting the specimens.



1. Touch  on the main menu to enter the test



2. Touch  to enter the filling/preheating option.

3. Allow the machine to fill and heat the water.

**NOTE:** The lid must be shut for the machine to start filling and heating the water.

4. Once the water is heated, touch  to stop the preheating mode and return to the test setup screen to select the appropriate test parameters.

## *Delayed Preheating*

If the water preheating should be performed when no one is present, such as overnight, a different set of procedures is necessary. The testing parameters in

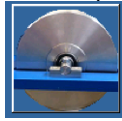

the main test function must be adjusted to preheat the water bath for this case.

1. Set the testing parameters to Preheat the water
  - a. Select the Start Mode
    - i. Immediate – Water filling and heating will start now.
    - ii. Delayed – Water filling and heating will start after a certain number of minutes.
    - iii. Timed – Water filling and heating will start at a certain time (24 hour clock (00:00 - 23:59 hours)).
  - b. Set the preconditioning time to 1440 minutes (24 hours) to prevent the machine from moving the arms before inserting the specimen trays.

2. Touch  to enter the filling/preheating option.

3. Allow the machine to fill the tanks with water. Then touch  to stop the preheating mode and return to the test setup screen.

4. Turn OFF the water supply.

**NOTE:** For Delayed and Timed settings, the water supply is turned OFF before leaving the machine to prevent the water from overflowing while unattended. The machine will still heat the water at the scheduled time.

5. Start the delayed preheating by touching . Verify that the trays for the LEFT and/or RIGHT sides are in place. Confirm by touching .

6. Once the water is heated, stop the preheating mode and set the appropriate test parameters. Reset the preconditioning time to 30 minutes.

## INSERTING SPECIMEN TRAYS INTO WATERBATH

1. Slide the specimen tray down the guide rails and into the water bath as seen below.

**CAUTION:** Water can be hot enough when preheated to cause burns on bare skin in less than 30 seconds. Use elbow length rubber gloves, safety glasses, and other appropriate PPE to prevent burns.

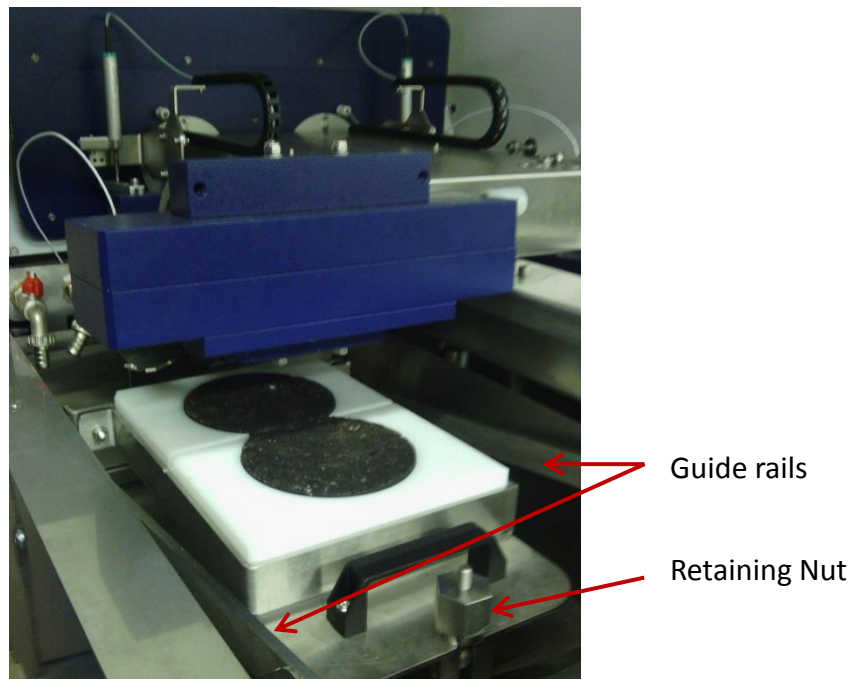

2. Tighten the retaining nut by hand to hold the specimen tray in place.

**NOTE:** The retaining nut should be tightened flush to the specimen tray. If the nut is tightened at an angle, loosen the nut, reinsert the tray firmly, and retighten the nut.

3. Close the lid.
4. Proceed to the TEST SETUP section to run the test.



## TEST SETUP



1. Touch  on the main menu to enter the test.
2. The main parameters screen will be displayed (as seen below). [Default – Combined]

### Combined Mode

### Individual Mode

## Default Test Parameters

The machine is capable of running the test in different modes, such as air or water testing, and at different temperatures and speeds. The software will be set up according to the standard used by the customer during installation. The table with the default parameters below can be used as a reference if these parameters are changed.

Parameter	Factory Default	Local Standard
Mode	Water (Combined)	
Pre-conditioning (minutes)	30	
Zero Passes	2	
Pause (minutes)	0	
Passes	20,000	
Rut Depth (mm)	20 (Enabled)	
Temperature Probe	Enabled	
Water Temperature	50°C	

3. Choose whether to test using the **Combined Mode** by selecting the Combined mode box or **Left / Right Mode** by deselecting the box. Combined mode runs both sides simultaneously using the same settings such as description (name),



water/air mode, temperature, cycles to failure, etc. Left / Right mode is designed for setting the test parameters individually for the left and right trays. For example, the machine can run a dry sample in the left tank and a wet sample in the right tank. The Left / Right mode also allows the user to *name the mixtures individually*. (Left / Right is based on facing the touch screen.)

**NOTE:** To run a dry test in the left tank and wet test in the right tank, the valve on the left water supply hose must be closed.

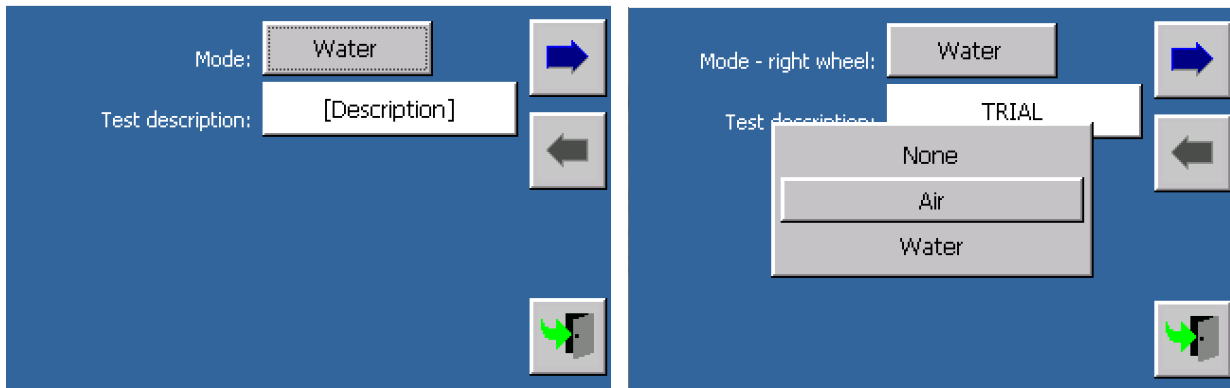
4. Set the **Speed** by touching the screen and entering the desired value (passes per minute). [Default – 52 passes/minute]
5. Set the **Start Mode**. (See descriptions on page 7)
6. Touch the **Mode** button (Water or Air) to enter the parameters to set up a test for a specimen. The following screen will appear.



7. Select the **Mode**. Select **None** to disable the test, **Air** to run a “dry” test, and **Water** to run a “wet” test. [Default – Water]. Only one side can be set to None.
8. Change the **Test description** by touching the description box; enter a name to identify the test with the virtual keyboard. The results will be automatically saved to a file with this name.

Pre-conditioning:	30	min	
Zero passes:	2		
Pause:	0	min	
Passes:	20000		
Rut depth:	<input checked="" type="checkbox"/>	20.00	mm
Temperature probe:	<input checked="" type="checkbox"/>		

9. Set the **Pre-conditioning** time (in minutes). The preconditioning time is the wait time after the air and water are heated to the desired temperatures. The AASHTO T324 default time is [30 minutes].
10. Select the **Zero passes**. The zero passes help seat the specimen before measuring the rut depth. During the last zero pass, the machine will acquire the reference measurement for the zero value of the rut depth. [Default – 2 passes, must be an even number]
11. Set the **Pause** time (in minutes). Pause time is the rest time between the zero passes and the passes. [Default – 0 minutes]
12. Set the number of **Passes**. [Default – 20,000 passes]
13. Set the **Rut depth** limit. This value is used to scale the graph during the test. In addition, it will be used to stop the test if the **Rut depth** is enabled.
14. Check/uncheck the **Rut depth**. If checked (enabled), the test will stop when the rut depth is equal to or greater than the input value. [Default – Enabled at 20 mm]
15. Check/uncheck the **Temperature Probe**. The temperature can be controlled by the individual temperature probes in the specimen water baths or by the probe in the bottom tank. To select the probes in individual water baths, select this option. [Default – Enabled]



16. Touch  twice (x2) to return to the main test setup screen (step 2) with the first parameter of "Test Description".
17. If in left/right mode, touch the **Mode (right)** button to enter the parameters for the specimen on the right side of the machine. Change the parameters by following steps 6-16.

18. Set the **Water temperature** and/or **Air Temperature**. Touch  to enter the temperature control (as seen on the next page).

**NOTE:** To regulate the air temperature, an optional air heater must be installed.

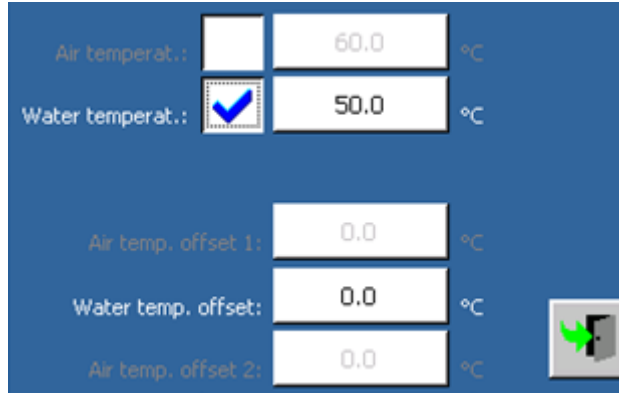

Air temperaturat.:	<input type="text" value="60.0"/>	°C	
Water temperaturat.:	<input checked="" type="checkbox"/>	<input type="text" value="50.0"/>	°C
Air temp. offset 1:	<input type="text" value="0.0"/>	°C	
Water temp. offset:	<input type="text" value="0.0"/>	°C	
Air temp. offset 2:	<input type="text" value="0.0"/>	°C	

19. Check/uncheck the **Air Temperature** and **Water Temperature**. If checked (enabled), the machine will heat the air and/or water to the setpoint before beginning the preconditioning.

20. Set the **Water temperature** and/or **Air Temperature**. [Default – Water enabled at 50°C].

21. Touch  to close the screen.

## PERFORMING THE TEST

1. Make sure that the machine is ready (  in the status bar). If not, check *Alarms*.

2. Check that a USB thumb drive has been inserted into the slot on the right side of the control panel so the data can be automatically saved.



3. Touch  to start the test.

4. Verify that the trays for the LEFT and/or RIGHT sides are in place. Confirm by touching .

5. The test status will be displayed on the screen below. The figure is labeled to describe what each value represents. It will change as the test progresses.

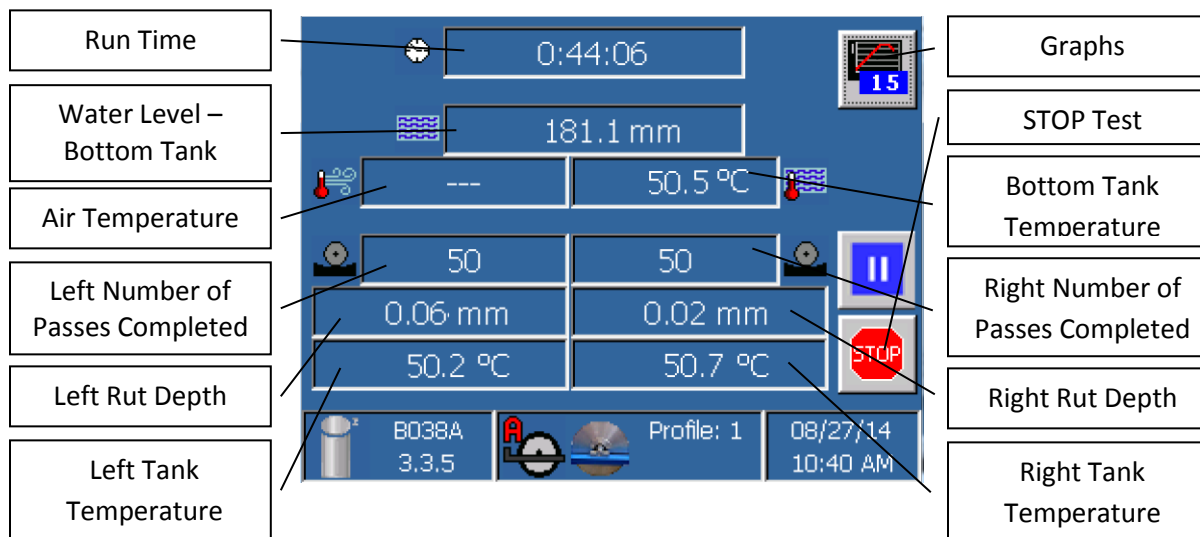

*Stage 1: Filling the tanks; heating the air and water*

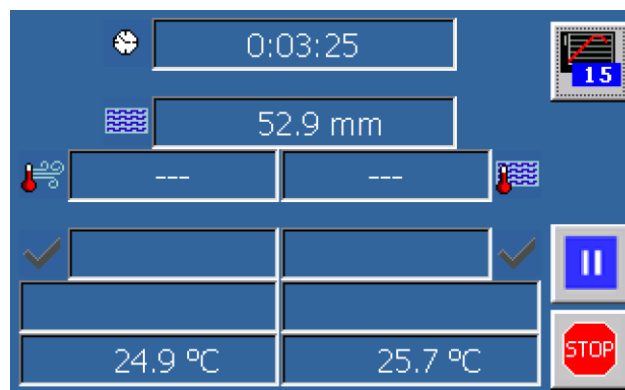

Water will fill the bottom tank, and then fill the top tanks. The bottom tank level will change as it fills. The machine starts heating the water at the default level of 70 mm. Temperatures of the air and water will increase until reaching the setpoints.

*Stage 2: Preconditioning*

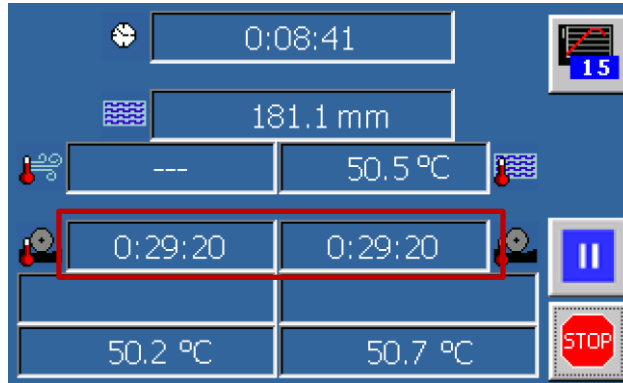

Temperatures are maintained at the setpoints (within +/- 1.0°C) while the machine counts down the remaining preconditioning time.

*Stage 3: Test*

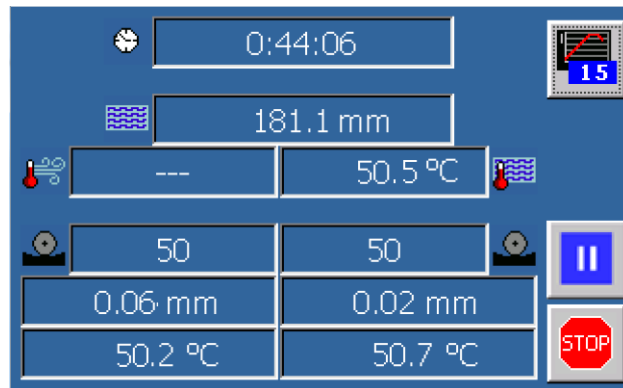





No rut depth values are reported for the zero cycles. These cycles are designed to stabilize and seat the specimens.

During the test, real-time rut depth values are displayed on the screen with the current number of cycles and temperatures for both water baths. The data will be automatically recorded to the USB thumb drive.

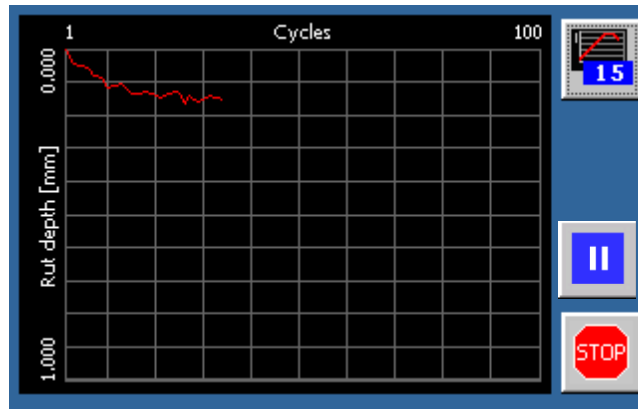

6. Touch  to switch between the numeric and graphic results during testing.



7. Press  at any time to stop the test.
8. Press  to pause the test. This will stop the arms from moving and the lid can be opened. After pausing the test, press  to continue the test.

**NOTE:** The heater will not run during the pause, so the pause should be as short as possible.

9. The test for each side will finish independently when the number of passes is completed or the rut depth limit is reached (if enabled).

## RESULTS

1. A summary of the test results will be displayed automatically at the end of the test.

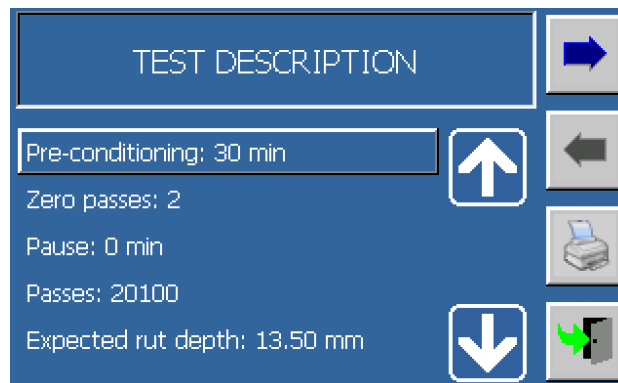

**NOTE:** If the screen shows ??? in each box, no testing was performed. Check the

Active Alarms  in the main menu to determine a possible cause.

2. Touch  to alternate between the numeric and graphical summaries of the test results.



3. The stripping inflection point and passes to failure (12.5 mm or 0.5 inches) will be calculated automatically. The results will be plotted as points on the graphs.

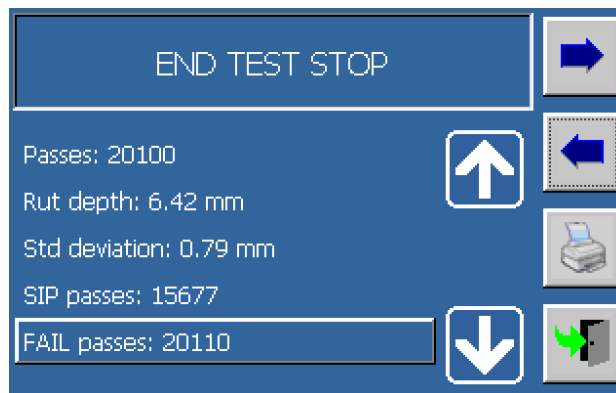

- Rut depth: Final rut depth measured at the end of the test.
  - Std deviation: This value is the statistical standard deviation of the middle 5 points. It is used to prevent damaging the machine if the rutting is excessive.
- NOTE:** If one arm stops earlier than expected, check if this value is  $\geq 3.00$  mm. If so, the arm stopped at the default value to protect the machine.
- SIP Passes: The stripping inflection point (SIP) represents the point that moisture-induced damage starts to dominate the rutting. The SIP is calculated by fitting two lines to the rut curve. The data is smoothed by fitting a 4<sup>th</sup> order polynomial to the curve. The first line is tangent to the point on the curve with the shallowest slope. The second line is tangent to the point on the curve with the steepest slope. The intersection of these points is the SIP passes.
  - FAIL passes: The passes to failure is the number of passes when the *measured* rut depth is greater than the rut depth set in the parameters.



## CLEAN UP

Perform these steps to clean the machine after *each* test. This helps ensure repeatable, quality results and a long machine life.

1. Drain the water using the valves on the right-hand side of the machine.
2. Clean the wheels by scrapping off any residual asphalt with a putty knife or similar dull blade. Heat or mild solvent such as WD-40 or orange cleaner can be used to remove the final residual asphalt layer.

**NOTE:** The use of harsh solvents, such as acetone or paint thinner, is not recommended because it can damage the bearing seals of the wheels.

3. Use rags or a *wet-vacuum* to remove the residual water and debris from the water baths.



4. If necessary, press  in the main menu to add more water to the tanks to assist in cleaning. This will fill the bottom tank first, and then add water to the top tanks.

## DATA STORAGE AND PRINTING



1. Press  to enter the screen below to store and print the rut depth history.

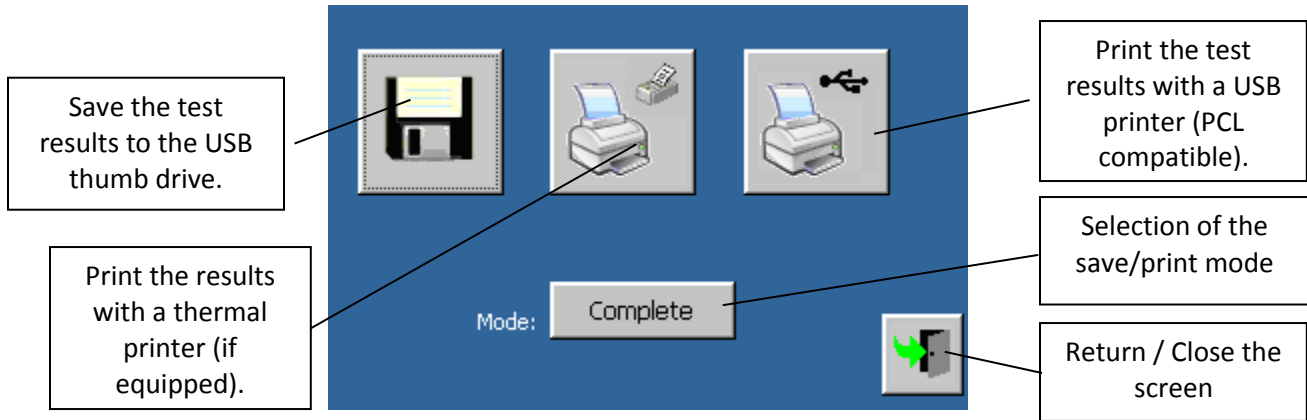

2. Select the **Print mode** (**Partial**: numeric values only – **Complete**: numeric values and graphs). The print mode is ignored when the results are printed on a USB printer (PC compatible).



3. Press  to print the test results using a thermal printer (if assembled on the machine).

4. Check that a printer (PCL compatible) is connected to the machine and press



to print the test results on the USB printer.

5. Check that a USB thumb drive has been inserted into the right side of the control



panel and press  to save the test data. Test results will be saved on the thumb drive. The file will be named with the “test description” name (set in TEST SETUP – Step 4), and will include the test date and time.





6. Close the storage and print screen by touching .

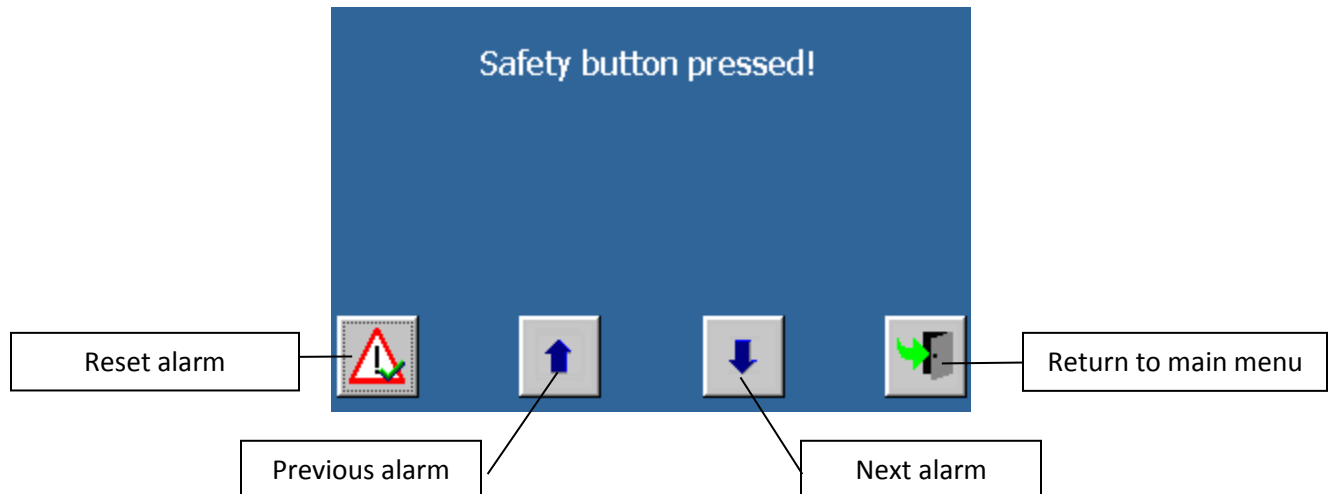

## Alarms



### *How to confirm and reset an alarm*

1. Scroll through the list of the active alarms (  or  ) until the desired alarm is shown.
2. Confirm and reset the alarm by pressing .
3. If alarm quickly reappears, the cause of the alarm is still active. For example, if the emergency stop switch on top of the controller is pressed, the alarm will not clear until it is released.





## Manually Position the Loading Arm

This function allows the user to position the wheel at the back, center, and front of the mold. This function is helpful when verifying the calibration of the device. The directions are based on the user standing in front of the machine and opening the lid.

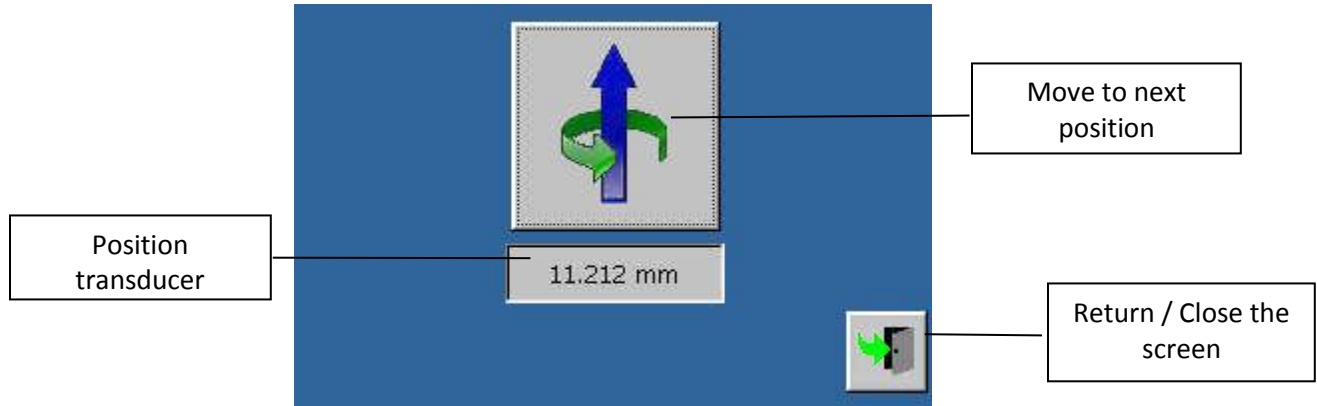

If this function is activated, the machine will bring the wheel to the back of the



mold. Press  to move to the next position. The arm moves out and back like the machine is performing a pass. The movement follows this pattern:

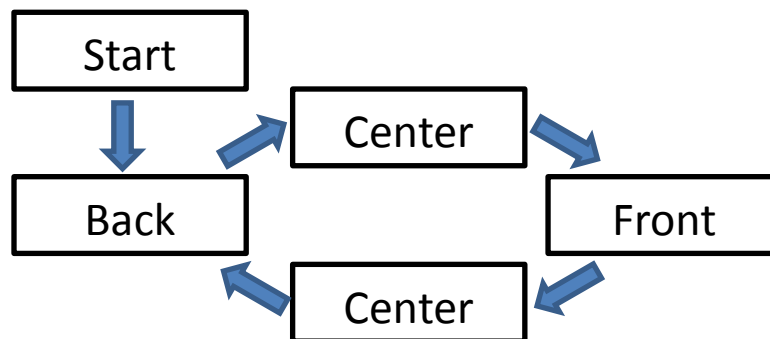

**WARNING:** As soon as this function is confirmed, the arm will move forward if door is closed. Check that the loading arm will not damage the equipment. It is recommended to insert something to support the arm as it moves back and forth (i.e., dummy sample, wood block, etc.).





## **Test Archive**

This function allows the user to review any tests that are stored on the USB thumb drive currently attached to the machine.









## **System Configuration and Calibration**

The section provides information on setting system parameters that are adjusted for optimal performance. The system configuration is divided into two sections: Device Configuration and Channel Configuration. The device configuration includes parameters that control the limits of the machine. Usually these parameters do not change. The channel configuration allows the verification and calibration of the measurement sensors on the machine. If you need access to these settings, please contact InstroTek, Inc. at (919-875-8371).



## **Control Panel**

The control panel menu allows the configuration of the software of the machine. The menu includes the following items:

-  Date and time.
-  International settings.
-  Touch screen calibration.
-  Network connection.
-  Password change (protected by PASSWORD – contact manufacturer).
-  Software maintenance (protected by PASSWORD – (default – 5555)).
  - Options include updating software, creating a backup of machine configurations, and restoring the machine configurations from a backup.





# Maintenance

Maintenance of the machine is necessary for a long life and quality results.

## Preventive Maintenance Items

### Frequency - Every 10 tests

1. Remove the protective cover over the drive screws by removing the 2 small screws.

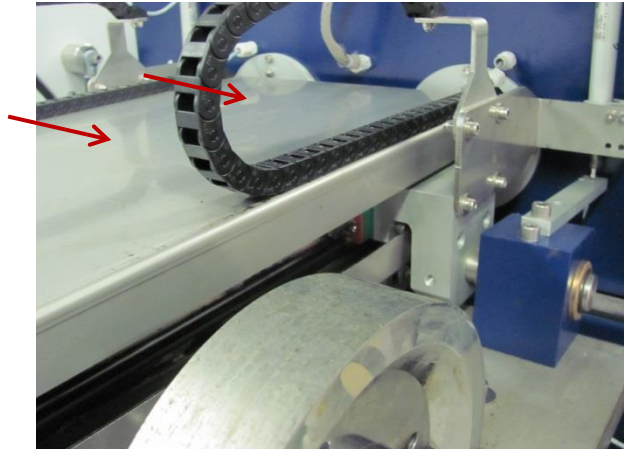

2. Lubricate the rails that guide the loading arms. Apply spray *lithium* grease to the guide rails (rectangles below).

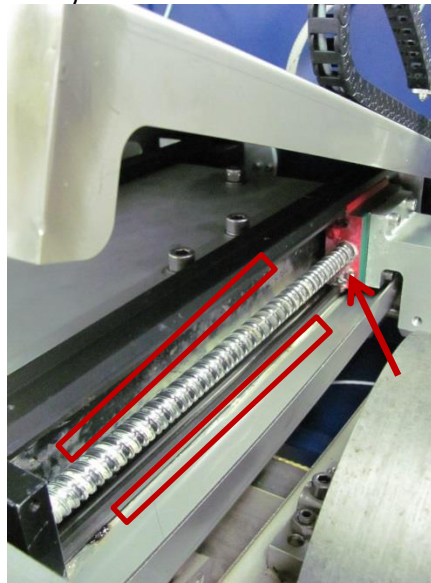

3. Lubricate the grease ports on the screw drive (arrow in picture above). Apply 1-2 pumps of *lithium* grease using a grease gun to both moving arms.

## Frequency – Monthly

4. Perform general cleaning using a damp clean cloth to remove dirt from the rails and screws.
5. Clean all machine parts with a damp cloth to remove dirt. Do not use solvents because they can damage the paint and machine components.

## Water Temperature Offset – Check every 3 months.

If the SmarTracker seems to be taking a longer time than usual to start, there could be a difference in temperature between the top and bottom tanks. A difference can occur because the water is heated in the bottom tank and then pumped up into the top tanks, where it is exposed to the air. The machine has an offset to adjust the water temperature between the top and bottom tanks.

To adjust the offset:

- 1) Determine the current difference between the top and bottom tanks by starting a test with the machine at room temperature. Write down the temperature of the bottom tank and the top tanks.

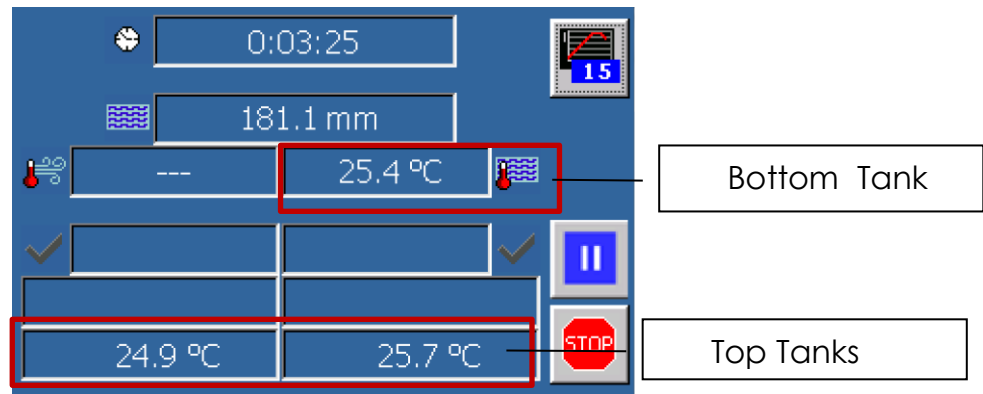

- 2) Calculate the offset.

$$\text{Offset} = \frac{\text{Left Tank} + \text{Right Tank}}{2} - \text{Bottom Tank Temperature}$$

In the figure above, the offset is  $(24.9+25.7)/2 - 25.4 = (-0.1)$ .

- 3) Change the offset by entering the test setup menu  and touch .

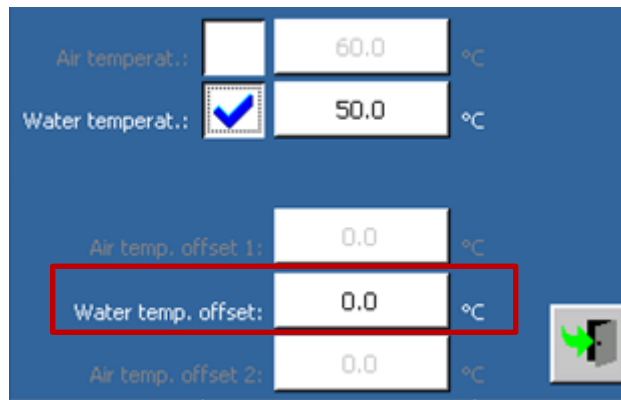

- 4) Add the calculated offset to the offset already in the menu and enter the new offset.
- 5) Verify the offset by running the machine and heating water to the desired temperature. Once the temperature has stabilized at the setpoint for the bottom tank, allow 30 minutes for the top tanks to stabilize. Verify that the difference is less than 0.5C. If not, adjust the offset based on the hot water values.

### 3) Tightness of Bolts - Check every 3 months

Inspect for loose bolts on the machine.

- 1) Check that bolts are tight for weights, wheel, and LVDT (see picture below)

**NOTE:** The weight may look different than the weights shown in the picture below.

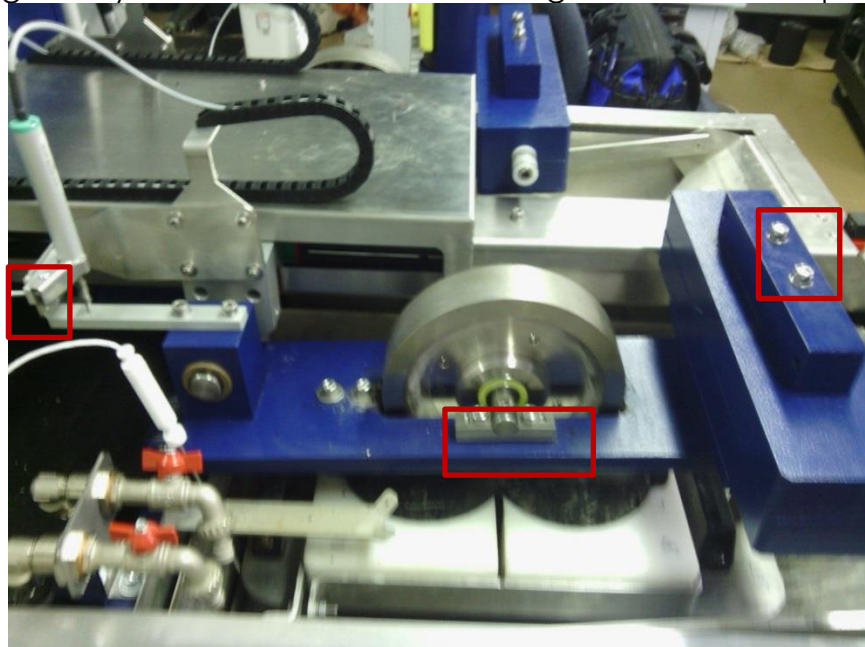

2) Check if the bolts in the picture below are loose. These bolts help keep the loading arms level. Also, check that the (3) set screws (red arrows) that hold the arm onto the screw drive are tight.

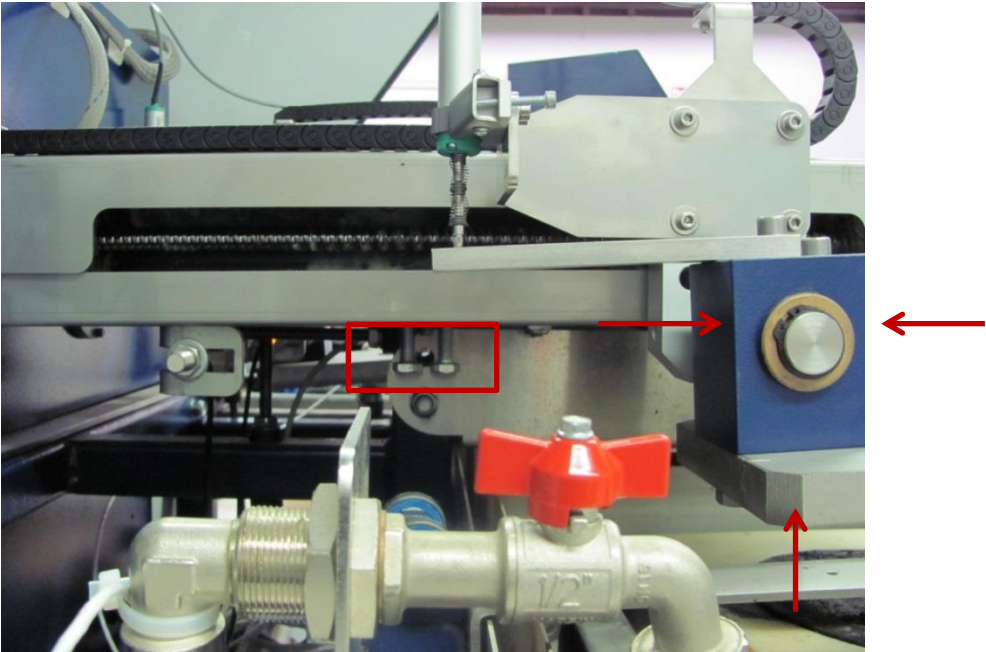

## **Warranty**

InstroTek extends a 1-year warranty on the SmarTracker to the original purchaser of this equipment. This warranty covers defects in material, workmanship, and operation under the conditions of normal use and proper maintenance.

This WARRANTY DOES NOT cover the replacement of the parts due to improper setup or running the unit without sufficient water.

InstroTek will replace, free of charge, any part found to be defective within the warranty period.

This warranty is void if inspection shows evidence of abuse, misuse or unauthorized repair.

This warranty covers replacement of defective materials and workmanship only. It does not cover shipping charges, duties or taxes in the transport to and from the factory or authorized service center.

InstroTek's liability is in all cases limited to the replacement price of its products. InstroTek shall not be liable for any other damages, whether consequential, indirect, or incidental arising from use of its product.

If return of the product is necessary, please include return shipping directions, contact name, phone & fax number and a description of the action needed.

Call InstroTek, Inc. for shipping details at (919-875-8371).





***Contact us for top quality, best value and superior service!***

email: [sales@instrotek.com](mailto:sales@instrotek.com) ✦ visit: [InstróTek.com](http://InstróTek.com)

**CALL A LOCATION NEAR YOU:**

Headquarters: **Raleigh, NC** phone: **919.875.8371**

**Richmond, VA** phone: **804.353.9499** ✦ **Bensalem, PA** phone: **215.645.1064**

**Grand Rapids, MI** phone: **616.726.5850** ✦ **Denver, CO** phone: **303.955.5740**

**Las Vegas, NV** phone: **702.270.3885** ✦ **Concord, CA** phone: **925.363.9770**