

SORENTHIA 2 SCONCE

DUNN

DESCRIPTION

The fluted lines of this sconce are graceful in either a vertical or horizontal orientation.

DETAILS

Lead Time | 8-10 Weeks

Materials | Steel and brass

Dimensions | 24.5"H x 5"W x 3.75"D

Weight | 1 lbs





Canopy | 5" Diameter x 1" Depth

Lamping | 120V/60Hz, E26 sockets



Made In | USA

FINISHES

Metal finish options:

-  | Brushed Brass (B)
-  | Brushed Nickel (N)
-  | Oil Rubbed Brass (ORB)
-  | Black Poppy Powder Coat (BP)
-  | Country Cream Powder Coat (CC)

Metal detail options:

-  | Brass (B)
-  | Nickel (N)
-  | Oil Rubbed Brass (ORB)

Metal details include canopy screw caps

ASSEMBLING PRODUCT SKUS

SOR-2-SCO - **N** - **N**
model finish detail

Finish samples sold online.

(401) 400-0206
info@studiodunn.com
www.studiodunn.com

FRONT VIEW

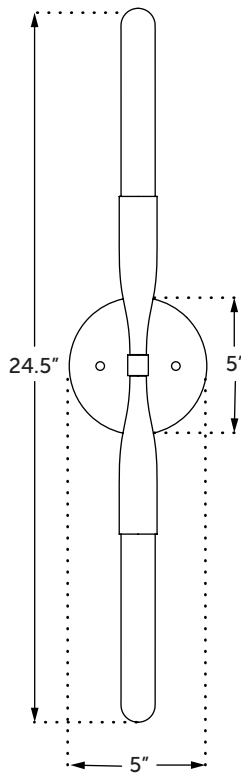

SIDE VIEW

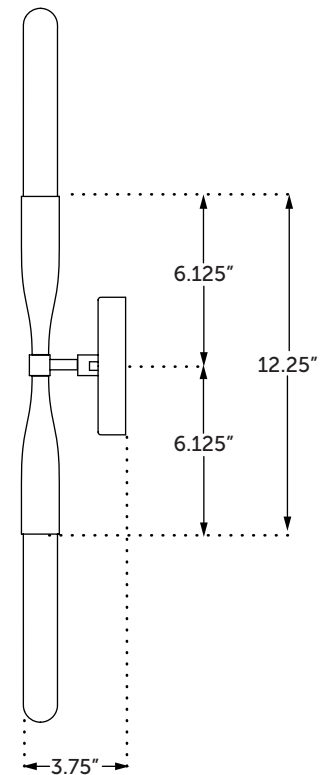

BULBS

Sold separately. Please visit our website for details. Many styles of bulbs work with our fixtures. Please refer to the lamping specifications to determine compatibility.

CUSTOMIZATION

This piece can be customized in length and configuration. Please contact us for more information.

CERTIFICATIONS



Each piece is built to order.

310 Bourne Ave
Building #1
Rumford, RI 02916

Designed by Studio DUNN, 2019

For quotes & custom inquiries
please contact Studio DUNN:
info@studiodunn.com