



**USER MANUAL**  
ZENO



# USER MANUAL

Download the complete user manual



Alfa Forni participates in the SAVE THE PLANET initiative; that's why the manual has been printed only in English. To download the other languages, scan the QR code or click the link below.



Alfa Forni partecipa all'iniziativa SAVE THE PLANET, per questo il manuale è stato stampato esclusivamente in lingua inglese. Per scaricare le altre lingue scansionare il QRcode oppure digita il link qui sotto.



Alfa Forni nimmt an der SAVE THE PLANET-Initiative teil. Die gedruckte Anleitung ist deswegen nur auf Englisch verfügbar. Um die anderen Sprachen herunterzuladen, scannen Sie den QR-Code oder geben Sie den Link hier unten ein



Alfa Forni participe à l'initiative SAUVER LA PLANÈTE et pour cela le manuel à été imprimé seulement en anglais. Pour télécharger les autres langues, flashez le code QR ou cliquez sur ce lien.



Alfa Forni participa en la iniciativa SALVAR EL PLANETA, por eso el manual fue publicado solo en inglés. Para descargar los otros idiomas escanea el código QR o haz clic aquí.

**RETAIN THIS MANUAL FOR FUTURE REFERENCE**



**DOWNLOAD USER MANUAL**  
**[www.alfaforni.com/user-manual-zeno.php](http://www.alfaforni.com/user-manual-zeno.php)**

**ALWAYS READ THE COMPLETE USER MANUAL.**  
**Further copies of this manual are available at [www.alfaforni.com](http://www.alfaforni.com)**

# Index

- **GENERAL WARNINGS.....3**
- **INSTALLATION.....5**
- **BASE.....10**
- **INSTALLATION BEHIND WALL.....11**
- **ELECTRICAL CONNECTION CE.....12**
- **VENTILATION.....14**
- **TOUCH SCREEN AND USER INTERFACE.....17**
- **ALARMS.....24**
- **FIRST USE AND IGNITION.....27**
- **CARE AND MAINTENANCE.....28**
- **TECHNICAL COMPARTMENT.....33**
- **F.A.Q.....36**
- **WARRANTY.....38**

**READ ALL INSTRUCTIONS BEFORE INSTALLING AND USING THE PRODUCT**  
Read the entire manual before proceeding with installation. Failure to follow these procedures could result in personal injury and death. Contact the appropriate authorities regarding any restrictions on installation.

## DEAR CUSTOMER

Before you starting using this oven, please read the following manual. Operator safety, equipment devices must be kept efficient at all times. This booklet is intended to illustrate the proper use and maintenance. It is the operator's duty and responsibility to abide by it.

## DECLARATION OF COMPLIANCE CE

Alfa Refrattari S.r.l - Via Osteria della Fontana, Anagni (FR), Italia - Declares that the electrical products comply with the following directives:

- Machinery safety. Basic concepts, general design principles.
- Specifications and technical principles. - **UNI EN ISO 12100:2010**
- Safety of household and similar electrical appliances.
- General Rules - Part 1 - **CEI EN 60335-1**
- Safety of electrical appliances for household and similar use. Part 2 - Special standards for electric cookers, ovens, electric hotplates for collective use. **CEI EN 60335-2-36 2017**
- Disturbances in power networks produced by household appliances and similar electrical equipment - Part2- Harmonics - **EN 60555-2-34**
- Disturbances in power networks produced by household appliances and similar electrical equipment - Part3 - Voltage fluctuations - **EN 60730-2-9**
- Electromagnetic compatibility - Generic emission standard - Part 1 - Residential, commercial and light industry environments - **EN 50081-1**
- Electromagnetic compatibility - Generic immunity standard - Part 1- Residential, commercial and light industry environments - **EN 50082-1 2014/35/UE, 2006/42/CE, 2004/108/CEE, 2014/30/UE**
- **CSA C22.2 No. 109**, Commercial Cooking Appliances, Edition 3, Revision Date 03/2021
- Alfa Refrattari S.r.l declares that the product, as per the technical file, complies with the above directives.

# GENERAL WARNINGS

**WARNING: Improper connection, as well as any alterations or improper maintenance, may cause material damage to things or people and even death in extreme cases.**

Please read the instructions carefully before installing and using the appliance.

## READ THE FOLLOWING INFORMATION CAREFULLY FOR A CORRECT INSTALLATION AND OPTIMAL OPERATION OF THE OVEN

- The data plate with the serial number, the model number and the mark is visibly applied to the oven. The data plate must never be removed.
- Check the appliance after unpacking. If any transport damage has occurred, do not use the oven.
- Before use, remove all plastic film protecting the appliance, blowing hot air to make it easier (hairdryer).
- This appliance is intended for professional use by qualified persons.
- Even though ALFA stainless-steel ovens include insulating materials between steel layers, they could overheat on the outside.
- During the switch-on phase, small muffled noises may occur; this should not cause concern, as this is only the material adapting to the change in temperature.
- Never allow children to get near the appliance when it is operating or to play with it.
- Never use steel sponges or sharp scrapers which could damage the surfaces. Use common non-abrasive products and, if need be, wood or plastic tools. Rinse thoroughly and dry with a soft or microfibre cloth.
- Never use plastic dishes or containers. The oven high temperatures could melt the plastic and damage the appliance.
- Use tools and cutlery that are resistant to high temperatures.
- Place the oven on a level surface and make sure to keep it away from objects and materials that might be damaged by heat or sparks.
- Due to the high temperatures, the colours of the exterior surfaces might vary in time.
- Do not paint the oven or put objects on it.
- The installation of the oven must allow for easy access for cleaning.
- Lock the oven casters to make sure your oven stays in place before using it.
- Do not move the oven during use or when it is hot.
- Never store flammable objects into the oven.
- Never insert sharp metal objects (cutlery or tools) into the ventilation slots.
- Never obstruct the ventilation openings or heat dissipation slots.
- Never place sealed containers or boxes into the oven. They can build pressure during cooking and can end up exploding.
- Never put flammable materials on the upper third under the oven chamber.
- Hold the handle when opening and closing the door.
- Do not touch the exterior surfaces and the flue when the oven is running.
- Do not use flammable liquids near the oven.
- Keep any electrical wiring and fuel line away from hot surfaces.
- Do not use the oven in case of breakage or malfunctioning.
- Do not lean or rest objects on the oven: they might compromise its stability.
- In case of grease fire, turn off the oven and leave the door closed until the fire goes out.
- The parts sealed by the manufacturer should not be altered by the user.
- Do not leave the appliance unattended during cooking that releases fats and oils: they can catch fire.
- Do not lift the oven from the shelf or the worktop.
- **Any modifications made to the device can be potentially dangerous.**



# SAFETY WARNINGS

This type of appliance is intended to be used for commercial applications, such as kitchens in restaurants, canteens, hospitals and commercial enterprises, such as bakeries, butchers, etc., but is not intended for the continuous mass production of food

For direct connection to the grid, it is necessary to provide a device that ensures disconnection from the grid, with a contact opening distance that allows complete disconnection in overvoltage category III conditions, in accordance with the installation regulations

## PLEASE READ THE FOLLOWING INSTRUCTIONS BEFORE INSTALLING AND USING THE OVEN.

Please read the entire instruction manual before installing this appliance. Failure to follow these instructions could result in personal and property damage or death. Please contact the local authorities for any restrictions on the installation.

**ONE OF THE MAIN CAUSES OF OVEN FIRE IS DUE TO THE NON-OBSERVANCE OF THE MINIMUM DISTANCE FROM FLAMMABLE MATERIALS OR IMPROPER INSTALLATION. IT IS OF THE UTMOST IMPORTANCE THAT THIS OVEN BE INSTALLED IN ACCORDANCE WITH THESE INSTRUCTIONS.**

**FOR YOUR SAFETY:** Do not store or use gasoline or other flammable vapours or liquids in the proximity of this or any other appliance. Always keep the area under and around this appliance free and clear of any combustible materials.

**WARNING:** Improper installation, adjustment, alteration or maintenance might cause personal and property damage and death. The device must be disconnected from its power source when in maintenance and when replacing parts

**FOR YOUR SAFETY:** If the power supply cable is damaged, it must be replaced by the manufacturer or its technical support service or in any case by a person with a similar qualification, in order to prevent any risk

**WARNING:** The appliance must not be cleaned with water jets or steam cleaners

**WARNING:** When the oven door is opened, be careful of the hot steam that may leak out

**WARNING:** The appliances must be disconnected from the power supply during cleaning, maintenance and replacement of the various parts.

**RETAIN THIS MANUAL FOR FUTURE REFERENCE**



**DOWNLOAD USER MANUAL**

**[www.alfaforni.com/user-manual-zeno.php](http://www.alfaforni.com/user-manual-zeno.php)**

**ALWAYS READ THE COMPLETE USER MANUAL.**  
**Further copies of this manual are available at [www.alfaforni.com](http://www.alfaforni.com)**

# UNPACKING OVENS

## TILES BLOCKING

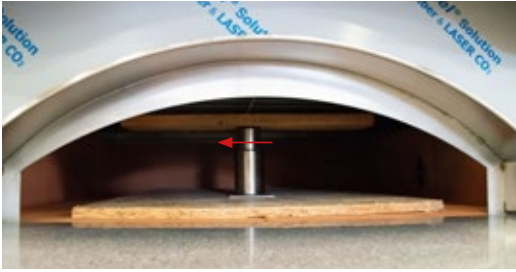

The oven is shipped with a tiles block internally so as to protect them during transport.

Before turning on, you need to remove it. In order to do this: hold the base of the metal cylinder still and rotate the upper part counter-clockwise.

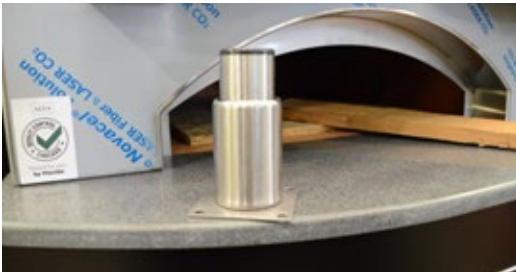

Once the metal cylinder has been unscrewed, remove it and the boards from the oven.

## OVEN HANDLING

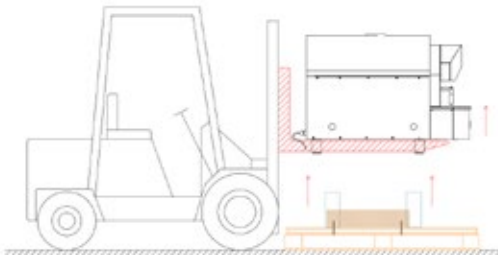

TOP OVEN

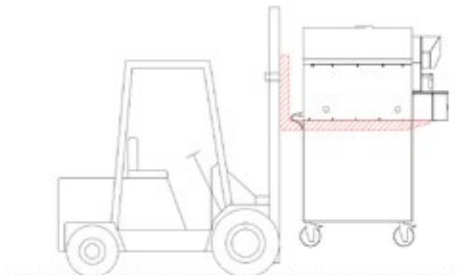

OVEN WITH BASE

# INSTALLATION

The local must have the following characteristics:

**OVEN SPACE:** Prepare adequate space when positioning the oven. For dimensions and weight, refer to the product data sheet.

**CHIMNEY:** for exhaust vapour, with an efficient damper suitable for receiving a pipe of a diameter of not less than 120 mm. Use the evacuation chimney with the compensation opening.

**POWER SUPPLY:** Three-phase line at least equal to the maximum oven power. Lower power may be installed as the oven is equipped with electronic control with power partializers (For more information contact the oven manufacturer). In any case, consider other electrical utilities to determine the power to be installed in the room where the oven will be installed.

**Should there be a need to connect a longer power cable, contact a specialized technician.**



**THIS APPLIANCE CANNOT BE COATED WITH FLAMMABLE MATERIALS. USE ONLY NON-COMBUSTIBLE MATERIALS TO BUILD IN THE OVEN.  
THE TOP PART OF THE OVEN CANNOT BE BUILT IN AND IT MUST BE KEPT CLEAR OF FURNITURE THAT COULD COMPROMISE ADEQUATE VENTILATION**

**ATTENTION:** do not occupy the minimum safe distance with insulation or other materials.

- Improper installation of this oven can cause fire; to reduce this risk, carefully follow the instructions.
- Read the entire instruction manual before installing this appliance. Failure to follow these instructions could result in personal and property damage or death.
- Leave enough space around the burner for proper maintenance.
- Remove the blocks inside the furnace chamber used for transportation.

## ATTENTION

the outer sides of the oven can reach temperatures above 50 °C (120 °F). Any flammable materials must not be within 1-metre radius of the oven.

**CAUTION:** When being used, place the oven at a safe minimum distance from flammable materials or any other substance that can be damaged by heat.

## FOR YOUR SAFETY

**Place the oven on a flat and stable surface.  
Involuntary movements during operation may result  
in personal injury and property damage.**



**CAUTION:** Place the oven at a minimum distance of 20 cm (8 in) from the wall or any other equipment. Increase the minimum distance to 50 cm around the flue and 1 m from the top of the oven.

**THE TOP VERSION OVENS SHOULD BE PLACED ON TABLES OR OTHER FIREPROOF SURFACES WITH ENOUGH LOAD-BEARING CAPACITY (for the weight, refer to the product data sheet attached to the instruction manual), ADJUST THE LEVELLING FEET TO HOLD THE OVEN STEADY.**

To move the oven more easily, remove the bricks inside the combustion chamber

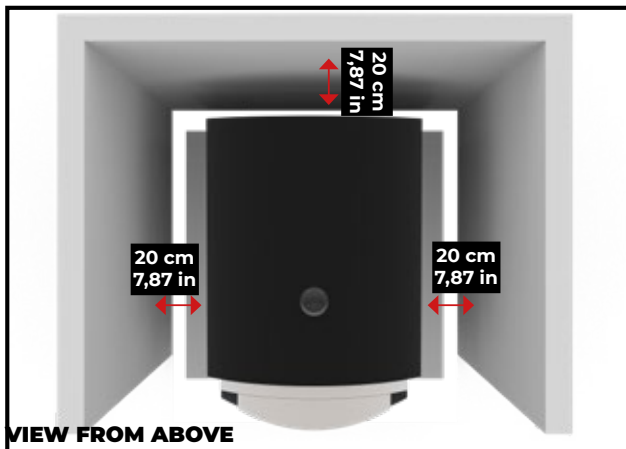
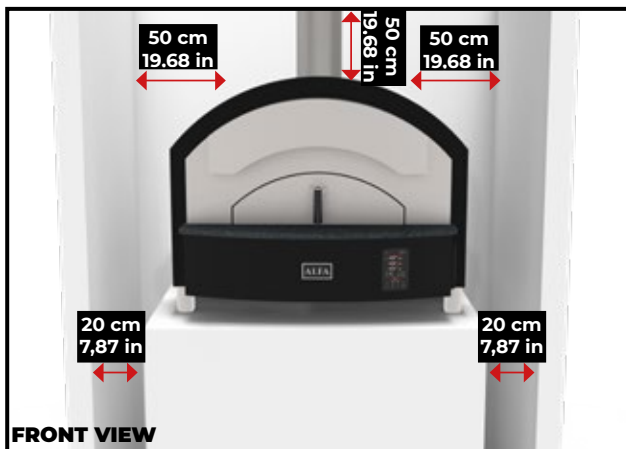

# BASE

- **Correct assembly:** Before using the base, check that all screws and parts are tightened tightly to ensure both stability and safety during use.
- **Load capacity:** Comply with the weight limit indicated for the base of the oven with wheels. Do not overload the base otherwise it could cause damage to the wheels or cause the oven to tip over.
- **Positioning surface:** Make sure to position the oven base on a flat and stable surface. Avoid placing it on slippery or unstable surfaces that could cause the oven to overturn.
- **Wheel locking:** The oven base is equipped with wheels that have wheel-brakes. Make sure to lock the wheels when the oven is in position so as to avoid unwanted displacements during use. Check the condition of the wheels periodically, making sure that they are in working condition and that they roll without obstacles. Lubricate moving parts and clean the oven base regularly to avoid accumulation of dust and dirt.
- **Safe use:** Use the oven base with wheels only for the intended purpose, i.e. to support and facilitate the movement of the oven. Do not use it as a ladder or support for other heavy objects.
- Wheel covers can be applied to the base of the oven.
- The cover is supplied disassembled, it will be necessary to screw the 3 pieces together using the screws provided.
- Once assembled, simply slide it under the base as illustrated in the images below.

## WHEEL COVER ASSEMBLY



1x 4mm Allen  
key

8x screws





Fix the lateral supports to the front using the screws supplied

Once the 3 components of the wheel cover have been fixed, place it under the oven and slide it to the ground.



# INSTALLATION

## BEHIND A WALL



**WARNING:**  
BUILT-IN INSTALLATION IS TO BE UNDERSTOOD  
AS INSTALLATION BEHIND A WALL

- The oven can be installed behind a fireproof wall leaving the non visible sides of the oven free and accessible (see img 3)
- Do not cover the oven with materials which would cause excessive overheating of the outside of the oven with possible paint deterioration
- Provide at least 2cm of air around the oven at the front (see img 1) to ensure easy removal in case of need.
- The premises must be well ventilated by providing suitable air vents.
- See ventilation section on page 14. Lack of air recirculation especially in gas ovens causes malfunctions
- Use fireproof materials for wall construction. (see img 1)
- For the vapour outlet, refer to the ventilation section on page 16.
- Install the oven on the base. When installing on a surface, make sure to screw the feet on.

Minimum distance between oven  
and wall opening >2cm

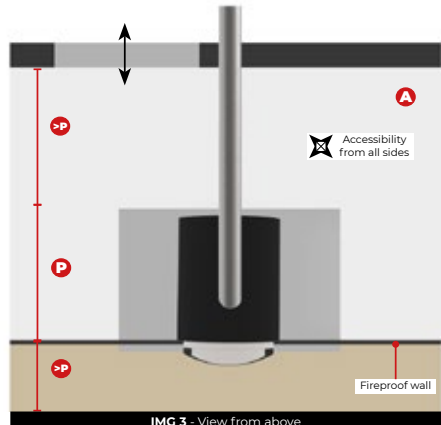
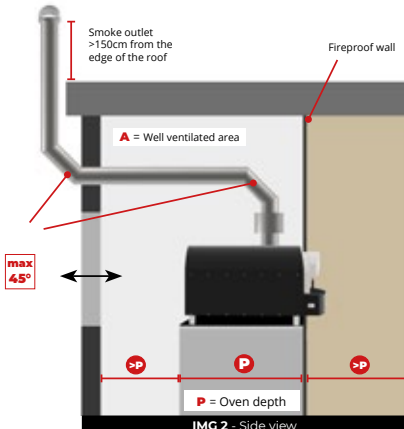
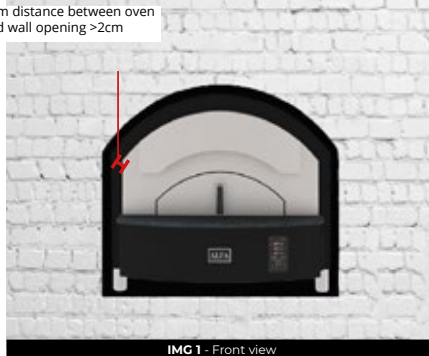

# ELECTRICAL CONNECTION

## CE VERSION

The product is supplied with cable of 1,5 m and with an electric plug. The electrical plug assembly and oven connection operations must be carried out by qualified personnel.

Should there be a need to connect a longer power cable, contact a specialized technician.

The oven supply cable must be connected to an external polarized circuit-breaker with minimum contact opening of 3 mm in the immediate vicinity, with the following minimum characteristics:

MODEL	MAX POWER	NOMINAL POWER	ELECTRICAL CABLE	POWER BREAK
	kW	Amp	mm <sup>2</sup>	kA
Zeno 4	13,5	19,5	5x6	10
Zeno 6	18	22	5x6	10

For direct connection to the grid, it is necessary to provide a device that ensures disconnection from the grid, with a contact opening distance that allows complete disconnection in overvoltage category III conditions, in accordance with the installation regulations

Over-current protection devices must comply with the relevant standards of the country of installation. The devices used for the connection must be approved for the country of installation. The degree of protection of the enclosures must be no less than IP 44 with the characteristics laid down in the standard of the country of installation. Verify that the oven has its earth terminal connected to an earth system that complies with the standard of the country of installation.

The Zeno oven is equipped with an equipotential terminal installed in the rear which, when connecting several electrical appliances, allows greater protection against accidental electrical discharges.





# CONNECTION TO THE CHIMNEY AND TO VAPOUR DISCHARGE

The connection operations of the oven vapour discharge chimney, must be performed by qualified personnel. The connection to the fireplace must be done through, a steel or aluminium tube of diameter not less than 120 mm. The damper of the chimney must ensure vapour evacuation in the most unfavourable weather conditions. Any fan in the room they must not compromise the damper of the chimneys. Pollutants such as hydrocarbons will not have to affect the chimney.

## VENTILATION AND AERATION

### VENTILATION

Appliances must be installed in rooms that are sufficiently ventilated to prevent the concentration of substances in the air.

### NATURAL VENTILATION

Natural ventilation can be obtained by using one or more permanent openings on walls/windows/fixtures or through ventilation ducts. The net area of the ventilation openings must be no less than 300 cm<sup>2</sup>.

The ventilation slots may be made in the walls, on the doors or the window systems of the room or the combustion air room facing outwards; they can be obtained by increasing the gap between doors facing outwards and the floor of the room or the combustion air room or they can be realised on the fixtures facing outwards as long as the free air flow is guaranteed and the net cross section is measurable.

The room ventilation can also be implemented by an individual or collective ventilation duct, provided that this pipework is impermeable to smoke and gas and it does not have changes in direction or sharp edges.

In case of indirect ventilation of the room where the gas appliance is installed, the circulation of air between adjacent rooms may be ensured with several air flow openings as long as each of them has a net cross-section area of no less than 200 cm<sup>2</sup>.

Such apertures can be made in the walls or in the doors of the common walls or can be obtained by increasing the gap between the inner doors and the floor of the premises as long as the free air flow is guaranteed and the net cross section is measurable.

### ATTENTION

**ALWAYS CONTACT A QUALIFIED TECHNICIAN.**

## **FORCED VENTILATION**

Forced ventilation can be obtained with systems equipped with electric fans. The actual flow rate must be no less than 1,72 m<sup>3</sup>/h per kW.

The air velocity near the installation must not disturb the operators and must have the following characteristics:

- The air velocity next to the exhaust hood must be between 0,25 m/s and 0,5 m/s.
- The make-up air velocity must be less than or equal to 0,15 m/s up to 2 metres from the walking surface.

The air flow vents in the premises, facing outwards, must have the following characteristics:

- To be conveniently located so as not to create a short circuit in the air flow.
- To be protected by grilles.



# AERATION

The required aeration may be obtained through the implementation of one of the systems described in the following paragraphs.

## FORCED AERATION SYSTEMS

The hourly flow rate of the system must be at least 1,72 m<sup>3</sup> per kW referred to the total rated thermal output of the installation

## NATURAL AERATION SYSTEMS

Total rated thermal output not exceeding 15 kW. Through permanent openings facing outwards in the room where the appliances are installed. The net area of the openings or the cross section must be no less than 100 cm<sup>2</sup>.

Total rated thermal output not exceeding 35 kW. Through exhaust hoods connected to the flue or duct with natural draught according to the UNI EN 13 384 guidelines.



➔ **NATURAL VENTILATION** -  $S=300\text{cm}^2$   
➔ **FORCED AERATION** -  $1,72 \text{ m}^3/\text{h} \times \text{kW}$

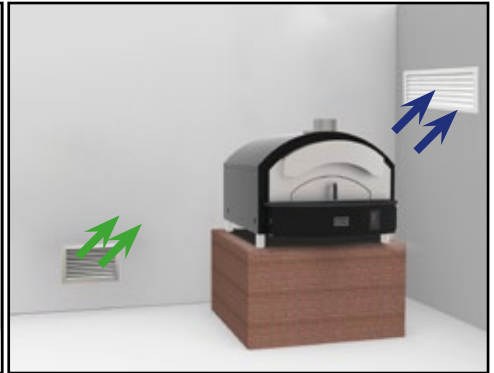

➔ **NATURAL VENTILATION** -  $S=300\text{cm}^2$   
➔ **NATURAL AERATION** -  $S>100\text{cm}^2$



➔ **FORCED VENTILATION** -  $1,72 \text{ m}^3/\text{h} \times \text{kW}$   
➔ **FORCED AERATION** -  $1,72 \text{ m}^3/\text{h} \times \text{kW}$



➔ **FORCED VENTILATION** -  $1,72 \text{ m}^3/\text{h} \times \text{kW}$   
➔ **NATURAL AERATION** -  $S>100\text{cm}^2$

# TOUCH SCREEN AND USER INTERFACE

## INITIAL INFORMATION

- **“STAND-BY”**: the device is powered up but switched off by the software; the loads are switched off.
- **“ON”**: the device is powered up and switched on; the loads can be switched on.
- **“OFF”**: the device is not powered up; the loads are switched off.

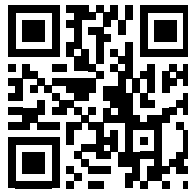

Video tutorial touch screen

## STAND BY SCREEN

Briefly press the ON/OFF key to switch on the device; pressing it for 3 seconds, switches it off.



The Planning key will also be displayed top left making it possible to set weekly programmed switch-on.



Set-up key displayed top right, makes it possible to access the date and time settings and to configure the parameters.



The 'Room Light' button allows the room light to be manually switched on or off even when the controller is in stand-by mode.



## CONTROL SCREEN

The control screen displays the following information and controls:

- Menu**: Located at the top left.
- Time and date**: 22/02/24 15:55 at the top right.
- Resistance status**: Three rows showing resistance values (234°, 210°, 214°) and set points (500°).
- Recipe steps**: 1/1 01:00, with a progress indicator.
- Temperature Ceiling** and **Set point Ceiling**: Labels for the top row of data.
- Temperature Floor** and **Set point Floor**: Labels for the middle row of data.
- Temperature Mouth** and **Set point Mouth**: Labels for the bottom row of data.
- Timer**: 00:01:00.
- Status bar**: PRERISCALDO at the bottom.
- Energy-saving mode**: Indicated by a crossed-out light bulb icon.
- Recipes**: Represented by a crown icon at the bottom.
- Light ON/OFF**: Represented by a light bulb icon at the bottom.
- Button ON/OFF**: Represented by a power button icon at the bottom.

# FUNCTIONS

In the Zeno oven, differentiated temperature management between Top, Floor and Front is achieved by setting the desired temperature values zone by zone. The temperatures can be set individually and are not bound to each other.

Settings on the display are:

- Status bar
- Energy-saving function
- Temperature and set point
- Power Ceiling
- Power Floor
- Power Mouth
- Cooking timer
- Light
- Recipe book
- Weekly programmed switch-on
- General settings and other functions

## STATUS BAR

When the device is switched on, the oven is already operating and the outputs are active according to the required settings. The status bar shows the function being performed by the oven.

**PREHEAT**

Pre-heating

**START**

Oven up to temperature  
cooking cycle can begin

**STOP**

Cooking cycle in progress

**COOKING FINISHED**

Cooking cycle terminated

## ENERGY-SAVING FUNCTION

The energy-saving function can be activated, except when rapid heating is in progress. This function allows the reduction of consumption by limiting the power of the heating elements. It can remain active until the deactivation button is pressed.



## TEMPERATURE AND SET POINT

How to set the temperature in the Zeno oven

The temperature setting is based on the chamber probe and the control outputs are the 3 relays (ceiling, floor, mouth).

Clicking on the temperature line takes you to the set point temperature setting screen. The temperature can be set in a range from 0 to 500°C

Once the oven has reached the temperature, the heating elements will work automatically to maintain the chosen temperature (red resistor line on, white resistor line off). The heating elements will restart when the detected temperature falls 5°C below the set point.

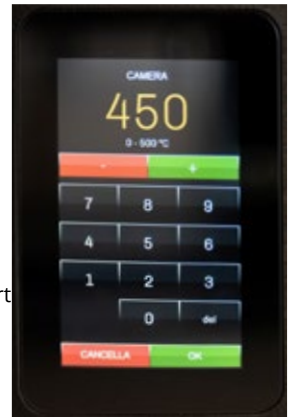

## COOKING TIMER

Touch the timer key to set the perfect time for baking pizza (one minute in the example); when cooking is finished, an alarm will sound.



## LIGHT

The On/Off light key manually switches the light on and off when the device is in stand-by or ON.



## RECIPE BOOK

### STORING A RECIPE

A maximum of 99 recipes can be stored. The recipe menu is accessed via the recipe button. A screen divided into 2 bins will appear:



The recipe book contains a main section "OEM RECIPES", where up to 99 recipes can be saved, and a second section, "MY RECIPES", where the user's favourite recipes in the main section can be displayed. This function gives quick access to the most frequently used recipes. The "OEM RECIPES" recipe book contains recipes uploaded by the manufacturer or previously created recipes, or default recipes which can be used to create personalised recipes. If a stored recipe is selected, a screen opens where it is possible to:

USE AS  
DEFAULT

Use the recipe for a cooking cycle



Delete the recipe (it will be overwritten by the default recipe)



Copy the recipe



Save the recipe



Include or exclude the recipe from the favourites

## PHASES

To configure a recipe (with one or more phases), press one of the available phases; this will open the following screen where it is possible to.



**DELETE PHASE**

Delete the phase (if there is more than one)

**ADD PHASE**

Add a new phase

To go back to the ON screen



To go back to the previous page.



**“WEEKLY PROGRAMMED SWITCHON” FUNCTION**

The “Weekly programmed switch-on” function allows the user to programme up to two recipes, each with 2 switch-ons, for every day of the week. The recipe is loaded and the oven heats up to the pre-set temperature for the recipe. To set it off, it must be started up manually using the appropriate key.

To access the procedure, operate as follows:

1. Make sure at least one recipe has been saved and that the device is in stand-by mode; if no recipes have been saved, the default recipe will be used.
2. Touch the key in the middle of the screen at the bottom. The following screen with the default recipe will appear (if it is the first time it is programmed):

To programme a switch-on, proceed as follows:

1. Select the day of the week.
2. Select one of the two recipes; choose which section to upload the recipe from (“OEM RECIPES” or “MY RECIPES”):

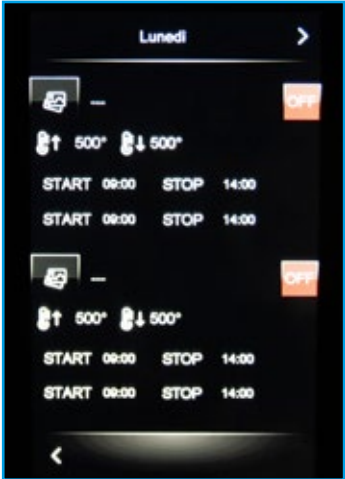

3. Activate the recipe using the OFF/ON key.



As soon as ON is pressed, two more keys will appear to set the times.



They will be set to OFF by default but can be changed by pressing the key:



ON will start up pre-heating of the set recipe, according to machine configuration.

4. Set the START and STOP times.

5. Once the programming for that day of the week is complete, it is possible to:



Delete the changes just made



Save the changes and exit; the controller will display the stand-by page with the details of the first programme closest in time



Save the changes and go to the next day.

If you programme a recipe with a programmed switch-on and switch-off time, be aware that the oven may lose the set programming in the event of a sudden switch-off due to a power failure or if the plug is pulled out. When restarting, this causes the automatically set switch-off to be lost and therefore the oven may not switch off at the set time and remain on. It then becomes necessary to act manually.

The weekly programme can be changed at any time by touching the key  and repeating the steps described above.





# INITIAL INFORMATION

On the Stand-by screen, touch the key  to access the menu with the following options:

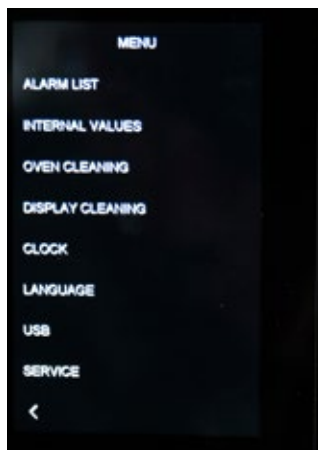

By selecting this option, the date and time can be changed and either the “EU” or “US” format chosen. In the event of “multi-base” configuration, this function can only be accessed if all the decks are in stand-by (this menu has a key which automatically puts all the ovens in stand-by).



## ALARM LIST

Selecting this option allows the active alarms page to be displayed.

ALARM CODE	DESCRIPTION
RTC ALARM	Rtc alarm To correct: - Set the date and time
Chamber/top probe ALARM	Chamber/top probe alarm To correct: - Check the type of probe; see parameter P0 - Check the device-probe connection - Check the chamber temperature Main results: - The temperature regulation output will be switched off
Floorro probe ALARM	Floor probe alarm To correct: - As in the previous case, but relating to the floor Main results: - The temperature regulation output will be switched off
Power failure ALARM	Power failure alarm To correct: - Check the device-power supply connection. Main results: - If the alarm is raised when the device is switched on or off, the device will switch off once the power is restored.

No connection ALARM	User interface-control module communication alarm To correct: - Check the user interface-control module connection. Main results: - The loads will be deactivated
Temperature ALARM	Ceiling/floor maximum temperature alarm To correct: - Check the temperature detected by the ceiling/floor probe.
High temperature ALARM	Operating temperature alarm To correct: - Check the operating temperature of the control module; see parameter A4 Main results: - The vent will open, the electronics compartment fan will switch on, the top and floor outputs and the steam generator will be switched off
	Door switch input alarm To correct: - Check the cause of the input activation
Safety thermostat ALARM	Safety thermostat input alarm To correct: - Check the cause of the input activation; Main results: -The ceiling and floor outputs and the steam generator will be switched off
ALERT Peak absorption	Electrical input absorption alarm Remedy: - Check the causes that triggered the input; Main consequences: - The ceiling output, stall output and steam generator mouth output will be switched off

## INTERNAL VALUES

Select this option to consult the oven parameters at the given moment.

## OVEN CLEANING CYCLE

The pyroscission cycle, referred to as the “oven cleaning cycle,” is a program that can be started when the controller is in stand-by. During this cycle, all heating elements run at maximum power until the set point is reached. Upon entering the options menu and pressing oven cleaning, the cycle will start immediately and a new screen will open where the following information is displayed: chamber temperature + cleaning cycle set, cleaning cycle time countdown. The oven will start the countdown and once the cycle is complete it will automatically return to the Stand-By screen

## DISPLAY CLEANING

When this option is selected, the display remains switched off for 15 seconds to allow the glass to be cleaned to avoid changing the displayed settings.

## IMPOSTAZIONI DATA/ORA

Selezionando questa opzione è possibile configurare la data e l'ora del dispositivo.

## LANGUAGES

Selecting this option allows the device to be configured with the desired language. It will be possible to select one of these languages: Italian, English, German, French and Spanish

## **USB**

It is necessary to have an empty USB support which is connected to the display, via the port inside the technical compartment. Select this option to import or export the parameter map or the recipe book and carry out software updates.

## **SERVICE**

Access to this section is password protected and only the retailer and manufacturer have access to these configurations.

**Unauthorised access will cause the product warranty to expire.**

Upon accessing this section, the Zeno oven allows you to intervene on the electrical board to set the default parameters.

SHOULD IT BE NECESSARY, PLEASE CONTACT EXPERT PERSONNEL AUTHORISED BY THE ALFA FORNI MANUFACTURING COMPANY.

## OTHER FUNCTIONS

### **FUNCTION BUZZER**

The buzzer is activated in the following situations:

- At the end of the cooking cycle
- For one second at the end of a cooking cycle phase
- On activation of an alarm

### **ELECTRONICS COMPARTMENT FAN**

Management of the electronics compartment fan depends mainly on the status of the device:

- If the device is switched on, the fan will switch on
- If the device is switched off, the fan will switch off

N.B.: The fan may remain on when the device is switched off if the operating temperature of the control module is above the 50° C threshold unless the main electrical voltage is completely removed.

# FIRST USE AND IGNITION

**BEFORE USE** Remove all plastic film protecting the appliance, blowing hot air to make it easier (hair-dryer). Never open with sharp objects.

**SILL** Do not use aggressive cleaning products on models that are equipped with a lava stone sill. Water and pure 30% pure alcohol are recommended: alcohol will dissolve the fat found on the stones and the water will capture it. Remember not to use any detergent or degreaser, as the stones absorb liquids.

Use neutral and non-aggressive detergents on models that have stainless steel sills. Simply use ethyl alcohol (or a solution made up of water and alcohol) for routine surface maintenance or to remove food stains or inevitable "finger marks" from stainless steel. The liquid can be sprayed or vaporized directly onto the surface and then dried with a soft, dry cloth.

If there is stubborn dirt, sodium bicarbonate mixed with some hot water is very effective. The result is a thick cream to be spread on the steel, left for a few minutes and then rinsed, drying well with a microfiber cloth. Furthermore, if needed, there are specific products on the market for cleaning steel. Always read the product label and check that it does not contain aggressive agents that could damage the stainless steel.

**DOOR** The oven door is an effective temperature regulator, handle the door carefully. Do not touch the metal parts of the door: open and close with the handle. Incorrect use could cause damage to the product.

## 1° IGNITION

When turning on the first time, smoke may escape from the heating elements. It is a normal phenomenon, insomuch as it is the protective oil placed on them that evaporates.

Allow the oven to warm up gradually and with the door open to allow the tiles to disperse excess moisture. Gradually bring the oven to temperature, increasing by roughly 100 degrees per hour. This enables the refractory tiles inside the combustion chamber to dry gradually.

### Warning

Keep in mind that the ground is the first thing to be connected to avoid risks related to leakage currents.

# CARE AND MAINTENANCE

**WARNING:** The appliances must be disconnected from the power supply during cleaning, maintenance and replacement of the various parts

MAINTENANCE CALENDAR	
CLEANING	TIME SCHEDULE
1 Cooking floor	Every use
2 Oven outside	Weekly
3 Stainless-steel parts	Weekly
4 Steel protection	Monthly
5 Rust spots	Biennially

## CLEAN THE COOKING FLOOR.

Wait for the oven to cool down and remove any food residues with the help of a brush.

## CLEAN THE OVEN OUTSIDE.

Like all 304 stainless and powder-coat products, Alfa ovens are built to withstand adverse weather conditions including salt air corrosion as long as punctual and effective maintenance is ensured. To clean stainless steel, use a soft cloth soaked in a solution of water and soap or alternatively with baking soda and dish detergent. Rub gently when the oven is completely cold.

**IMPORTANT:** always check the certification of the product you use and that the components are those declared.

**ATTENTION:** Steels subjected to high temperatures and direct flames tend to change color on the surface.

## CLEAN THE STAINLESS-STEEL PARTS.

ALFA ovens are made with 304 stainless-steel outside. To clean these parts, we recommend that you use a stainless-steel cleaner. Please carefully read the warnings and the instructions. Do not use detergents containing acids, white spirit or xylene. Rinse well after cleaning the oven.

## PROTECT STAINLESS STEEL.

To better protect the stainless-steel parts, we suggest using Vaseline or olive oil or baby oil as substitutes. In the case of beach front installations, to avoid salty air corrosion and white thin layers, often clean the oven with fresh water.

## REMOVE RUST SPOTS.

Stainless steel is rust-proof but in some cases (humidity, salty air, sea spray...) some rust stains might appear. Use a rust remover to make your oven shiny and new once again.

**WARNING**

Before any oven cleaning operation make sure that there is no voltage. To do this, open the external omnipolar switch.

**WARNING**

Do not clean the oven with cleaning products. Do not use water to clean the control panel. Simply wipe with a damp cloth.

**WARNING**

For any other maintenance not listed above, contact the manufacturer or authorized service.



**IT IS MANDATORY THAT AUTHORIZED OPERATORS USE GLOVES FOR PROTECTION AGAINST HEAT and POSSIBLY A PROTECTIVE GARMENT FOR THE PROTECTION OF THE BODY**

## **LAMP MAINTENANCE**

**WARNING:** carry out operations only when the oven is cold and disconnected from the power supply



1. Disassemble the painted casing on the right side by unscrewing the fixing screws (use a star screwdriver)



2. Unscrew the 2 fixing screws on the locking grid and remove the lamp to be replaced.

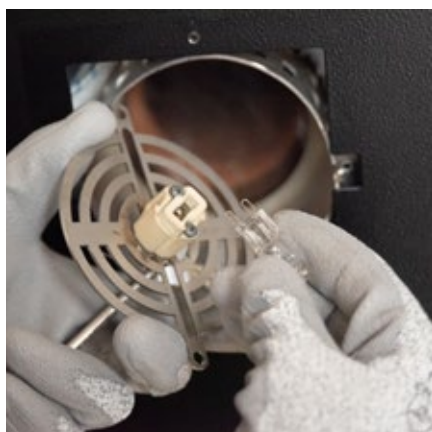

3. Unscrew the lamp and install the new one, taking care that it is not directly in contact with the internal glass



4. Follow the steps in reverse to reassemble everything

# REFRACTORY FLOOR MAINTENANCE

**WARNING:** carry out operations only when the oven is cold and disconnected from the power supply

**REFER TO THE DIAGRAMS ON THE NEXT PAGE**



**1.** To replace the refractory surface or a single tile, remove the lava stone sill. To remove the sill, simply pull the surface towards you.

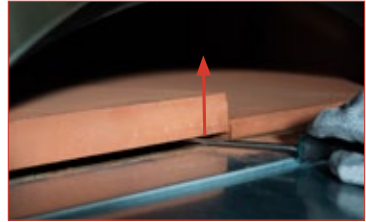

**2.** With the help of a screwdriver, lever out a tile and lift it to extract it. In order to remove the tiles in the back, you must first remove the front ones.



**3.** Replace the new tiles and re-install the sill

**4.** Warning: the temperature probe is inserted inside the right front tile. Be careful when replacing.

- To remove the left side tiles, remove the top tiles first and then slide the side tiles inwards.
- To remove the right side tiles, first remove the temperature probes from the right panel, then the floor tiles and finally allow them to slide.
- To remove the bottom tiles, first remove the top tiles and then slide the tiles inwards.
- Unscrew the right side panel in order to remove the upper tiles, then remove the fibre-ceramic in the upper part, remove the crosspiece that holds the tiles in position. At this point you can access the tiles and they can be replaced by sliding them towards the outside and pulling them towards you.
- NOTE: it is important to carry out the above steps in reverse order to reposition the fibre in the correct position so as to ensure insulation. These operations must be carried out by a qualified technician.



# PIANI ZENO 4

## ZENO 4

CEILING

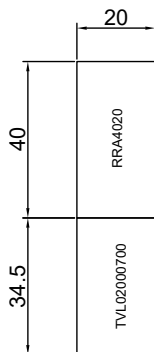
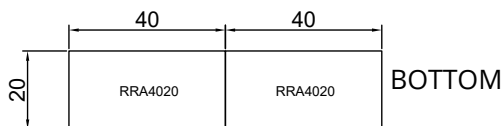
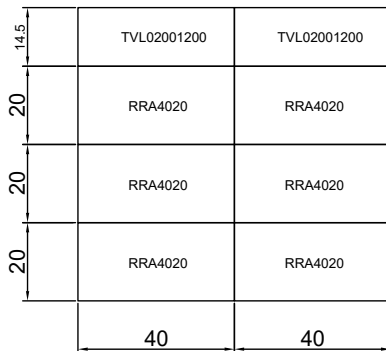

LEFT

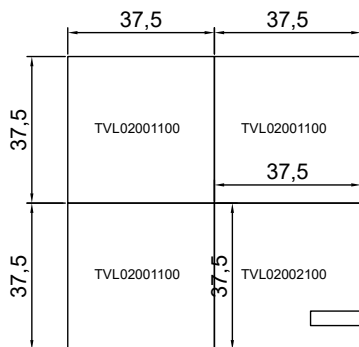

MOUTH

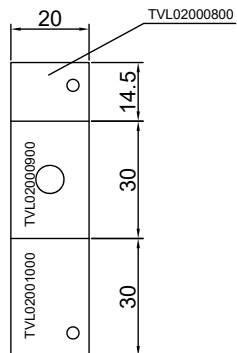

RIGHT

# PIANI ZENO 6

## ZENO 6

CEILING

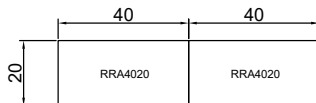
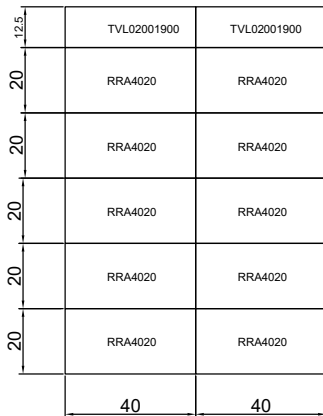

BOTTOM

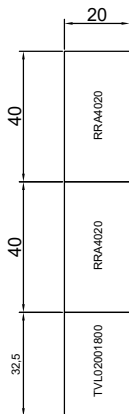

LEFT

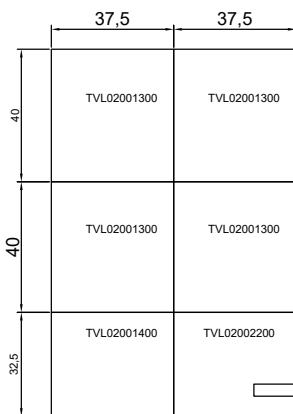

MOUTH

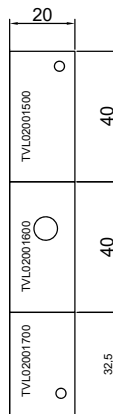

RIGHT

# RESISTANCE MAINTENANCE

- This must be done by a specialised technician
- The resistors are armoured type.
- Power: Upper heating elements 1500W, Lower heating elements 750W
- Make sure there is no voltage. Disconnect the oven from any power supply

**WARNING:** carry out operations only when the oven is cold and disconnected from the power supply



1. Disassemble the painted casing on the right side by unscrewing the fixing screws (use a star screwdriver).



2. Once all the screws have been unscrewed, you can proceed to remove the side panel. It is recommended that two people carry out the operation so as to avoid causing damage to the oven or the internal electrical circuit. Warning: the grounding system is installed on the panel. Pay attention to the cable. To disconnect the cable you need to unscrew the nut with a 7 wrench. Be sure to reconnect the grounding once the maintenance work has been completed.



3. Identify the damaged resistor by checking the continuity of current between the resistors' poles using a tester. (This operation must be done by a specialized technician).



4. At this point disconnect the 2 electrical connection fastener terminals and unscrew the 2 screws that attach the resistance to the oven structure. Unscrew the 2 fixing screws.



5. Once the 2 fastening screws have been unscrewed, remove and replace the resistor.

**WARNING:** Be sure to reinstall the electrical connections correctly.

**WARNING:** Correctly reposition the fibre that may move during maintenance

# TEMPERATURE PROBE REPLACEMENT

**WARNING:** carry out operations only when the oven is cold and disconnected from the power supply



1. To replace the probe, remove the side cover (see page on the side) and then loosen the fastening screw with a Phillips screwdriver.

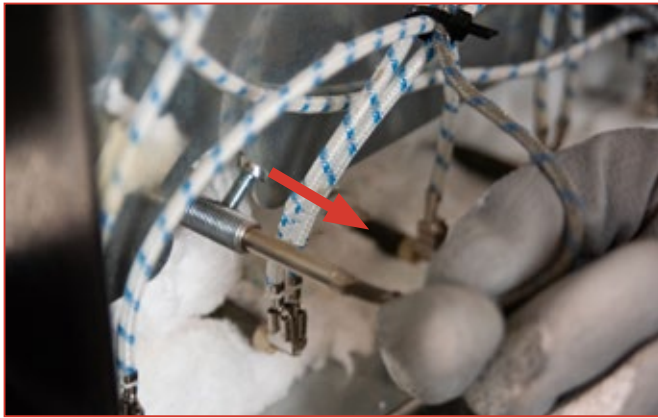

2. Remove the probe from its housing. Then disconnect the relevant contacts from the board (refer to page 38, Point A)



3. Insert the new probe into the housing until it is fully inserted and reconnect the electrical contacts on the board.

# TECHNICAL COMPARTMENT

## MAINTENANCE AND INSPECTION

**WARNING:** carry out operations only when the oven is cold and disconnected from the power supply



1. In order to remove the sill, simply pull the top towards you.



2. Unscrew the 3 locking screws of the steel protection



3. Lift the steel guard using a screwdriver.



4. You can now access the technical compartment.

- This must be done by a specialised technician.
- Make sure there is no voltage. Disconnect the oven from any power supply.
- In order to access the technical compartment, simply reattach the lava stone sill by pulling it frontally and remove the protective steel panel by unscrewing the three fixing screws.

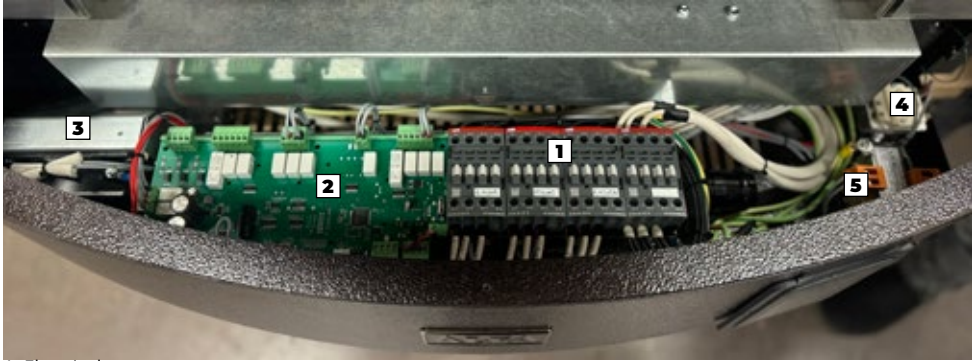

1. Electrical contactors
2. Electronic control board
3. Cooling fan
4. Safety thermostat
5. Transformer

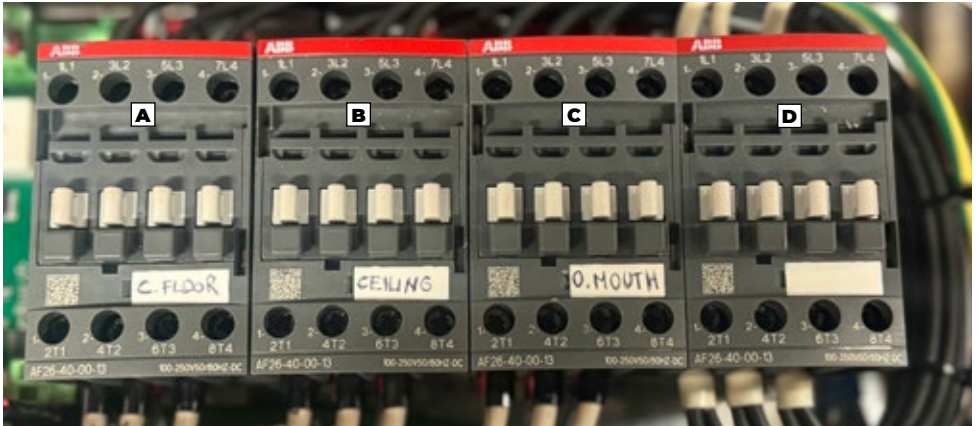

#### 1 - ELECTRICAL CONTACTORS

- A. Floor Contacts
- B. Ceiling Contacts
- C. Mouth Contacts
- D. Main power supply and safety thermostat contacts

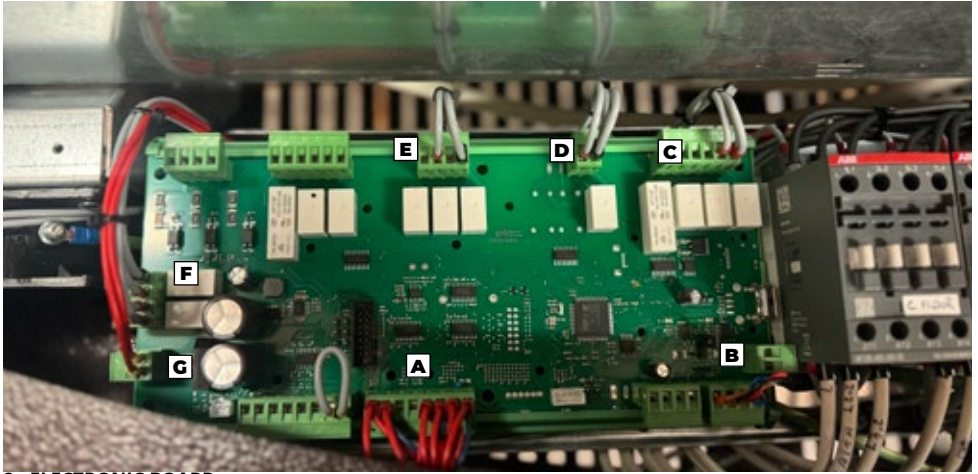

## 2 - ELECTRONIC BOARD

- A. Temperature probes (Floor, Ceiling and Mouth)
- B. EVCO touch screen connection
- C. Fan connection
- D. Inlet Contactor
- E. Oven light connection
- F. Slab and Upper contactor
- G. Transformer Connection

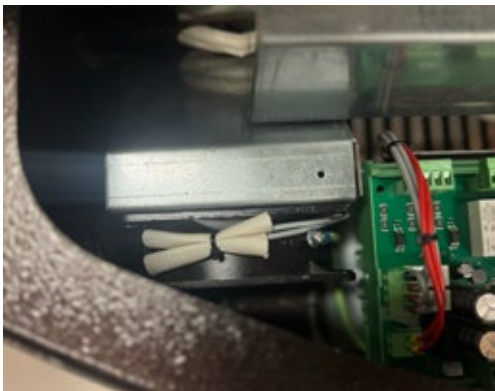

## 3 - COOLING FAN

It expels hot air from the technical compartment to keep it cool.



#### 4 - Safety thermostat

Equipped with a probe installed in the resistance compartment and intervenes in case of exceeding safety values. The thermostat is supplied reinforced and in case of intervention the reset must be done manually by pressing with a button tool.



The button is located at the bottom of the sill and it is necessary to press it with the aid of a tool in order to reset it.

#### 5 - Transformer

High voltage input and low voltage output for power supply of electrical components.

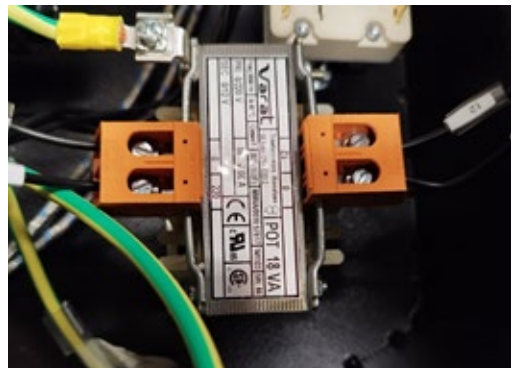



# FAQ

## The oven does not turn on

- Check that all electrical connections have been carried out correctly
- Check that the temperatures reached inside the technical compartment do not exceed 40°C. The system stops automatically. Cool down the oven.

## The oven does not rise in temperature

- Check that the voltage is correct
- Check that all the resistors are working

## The oven does not cook

- Check that the temperature on the surface is correct
- Check that the oven maintains the chosen temperature for the entire duration of use

## The oven cools down quickly

- Check that there is no water infiltration inside the oven

**WARNINGS IN CASE OF ACCIDENTS AND OVEN MALFUNCTIONS**  
**Do not place foods and other flammable materials inside the oven**  
**Disconnect the appliance from the power supply immediately**  
**Keep personnel not involved in product recovery operations away**

## DISPOSAL

When demolishing the oven, it is mandatory to comply with the provisions of the regulations in force. Proceed to differentiate the parts that make up the oven according to the different types of construction materials (plastic, copper, iron, etc.).



# WARRANTY



ALFA professional ovens are covered by a legally-required 12-month warranty against conformity defects. Good maintenance and proper use of the product will contribute to extending its lifespan.

The time limit for reporting defects is 8 days from their discovery.

For legal warranty regulations, please refer to the provisions of the individual national legislation of reference.

**YOU ARE REQUESTED TO KEEP THE PURCHASE RECEIPT OR INVOICE TO SHOW TO THE RETAILER. WE ADVISE YOU TO WRITE DOWN BELOW THE SERIAL NUMBER YOU WILL FIND ON THE IDENTIFICATION LABEL ON THE BACK OF THE PRODUCT.**

**In case of any warranty claims, please contact your dealer only. Under the Warranty, ALFA undertakes to remedy any faults and malfunctions which are demonstrably related to material or manufacturing defects. ALFA shall be entitled to decide, on a case-by-case basis, whether to repair the product, to replace it or to substitute defective parts, without prejudice to business agreements and national legislation of reference.**

**We recommend the exclusive use of ALFA branded spare parts**

## **The warranty does not cover the following:**

Damage caused by the carrier in the event of such damage not being indicated immediately on the transport document by marking the product "accepted with reservation" upon receipt and immediately contacting the seller for further clarification;

The case of the oven not being properly used and installed as described in this manual. In particular, in the event of the oven needing to be recessed at the time of installation, please follow the correct procedures indicated in this manual under penalty of invalidating the warranty;

The case of the oven being tampered with in any way, whether intentionally or unintentionally, or altered so it is no longer in the condition it was when the product was delivered;

The case of damage to the product due to obstruction of all smoke/fume outlets;

Failure to observe the proper product maintenance and cleaning instructions as set out in the manual;

Damage to the burner due to cooking residues or damage in cases where fuel other than that recommended has been used, e.g. use of liquid barbecue charcoal, chemicals or other fuel;

The case of components being used which have not been manufactured or recommended by Alfa;

The case of damage being the result of the use of chemicals inside or outside the oven;

Damage due to exceeding the temperature indicated by the pyrometer

provided, over 500°C (932° F), due to improper use of wood fuel;

The case of the label on the back of the product being removed, altered or erased;

The case of normal wear and tear of the product due to professional use;

Possible oxidation of the steel due to exposure to saline environments or near the sea.

Alfa specifies that possible oxidation is not due to quality defects in the product, but to intrinsic chemical-physical characteristics of steel in the event of prolonged exposure near saline environments;

Possible deterioration of the paint due to prolonged contact with flames;

Small surface imperfections on painted or aesthetic parts that do not affect the normal use of the product;

Accessory parts supplied with the product, such as the door;

Floors and underfloor insulation are not covered by the warranty. Alfa ovens are however supplied with a replacement floor;

As regards electrically powered products, the warranty does not cover light bulbs and any damage due to over voltage or the use of a power supply with inadequate power output and/or voltage;

The cost of the labour required to carry out the work under warranty.







