

## TUNGSTEN SMART-HEAT™ GAS

---

Our Tungsten Smart-Heat™ Gas heater has a durable, soft flowing curved fascia and engineered body, which produces formidable heat to create a truly comfortable outdoor space. Its easy pivot arm allows for greater positioning and directional heat control. This heater also has a range of accessories available to provide versatility in mounting & controller options.

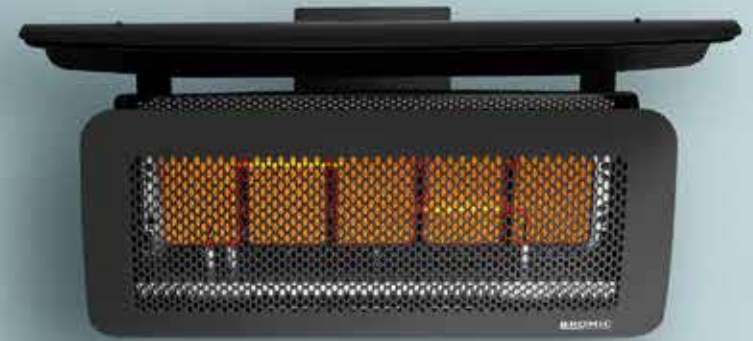

500 SERIES



300 SERIES

# SPECIFICATIONS

Reference the specification guide below to help you select the correct solution for your needs.

MODEL NUMBER	300 SERIES	500 SERIES
PRODUCT CODE	BH0210002-1   BH0210001-1	BH0210004-1   BH0210003-1
FUEL TYPE	LPG   NG	LPG   NG
COLOR	BLACK	BLACK
HEAT AREA	160FT	215FT
ELECTRICAL CONNECTION	110V/2A	110V/2A
MINIMUM FLOOR CLEARANCE	96"	96"
OUTPUT	26,000 BTU	43,000 BTU

## MOUNTING OPTIONS

CEILING MOUNT	✓	✓
WALL MOUNT	✓	✓
RECESSED   FLUSH MOUNT	-	-
CEILING POLE MOUNT	✓	✓
FREESTANDING	-	-

## CONTROL OPTIONS

ON   OFF	✓	✓
ON   OFF PRODUCT CODE	BH3130010-1	BH3130010-1
DIMMER	-	-
MASTER REMOTE	-	-

Measurements displayed within this catalogue are minimum requirements for installation. Bromic takes no responsibility for incorrect or non-compliant installations. All measurement in this catalogue are displayed in inches.

# DIMENSIONS

With a wide range of sizes available, find the ideal heater to suit your outdoor space.

## FRONT PROFILE

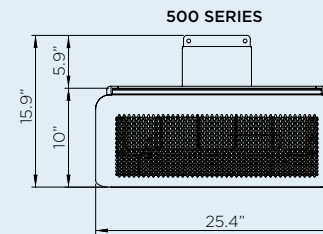

## + HEAT DEFLECTOR

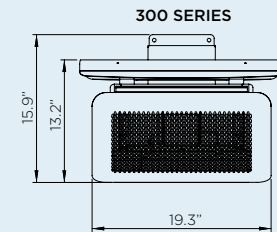
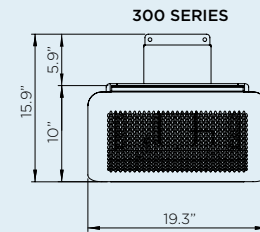
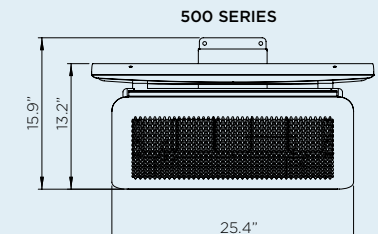

## SIDE PROFILE

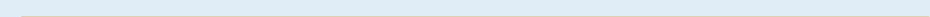
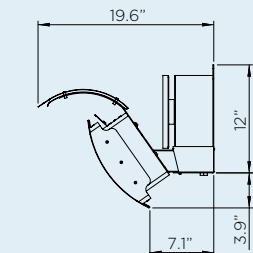
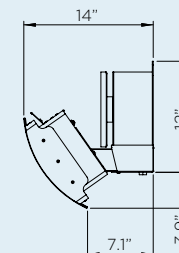

# MOUNT OPTIONS

With a wide array of mounting options, Bromic offers solutions to compliment any décor and provide functionality for ambiance and comfort.

## WALL MOUNT

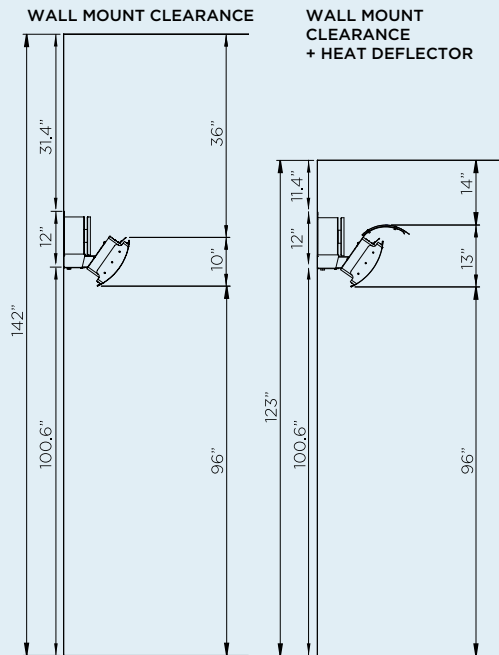

## CEILING MOUNT

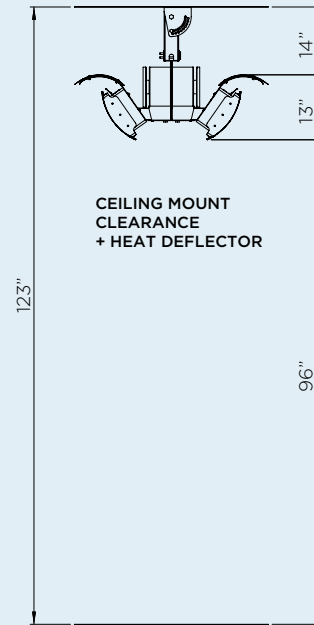

## WALL BRACKET

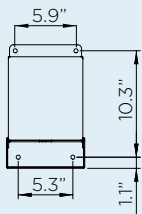

# HEATING REACH

Creating ideal comfort levels, Bromic heaters offer a variety of heat distribution options to suit your outdoor heating needs.

## 500 SERIES

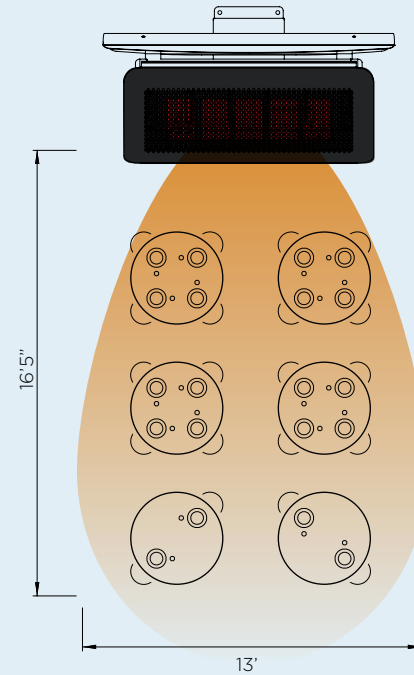

HEATING APPROXIMATELY 215FT<sup>2</sup>  
43,000 BTU HEATING POWER

## 300 SERIES

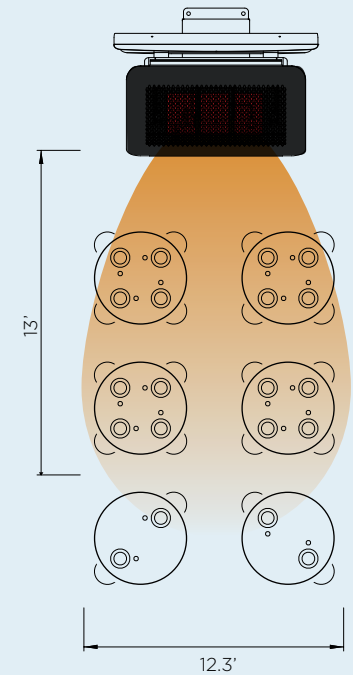

HEATING APPROXIMATELY 160FT<sup>2</sup>  
26,000 BTU HEATING POWER

## CONTROL OPTIONS



ON | OFF CONTROL



MASTER REMOTE



EXTEND YOUR COMFORT OUTDOORS  
WITH THE SUPERIOR HEAT AND  
AWARD-WINNING DESIGN OF OUR  
SMART-HEAT™ OUTDOOR HEATERS.

---

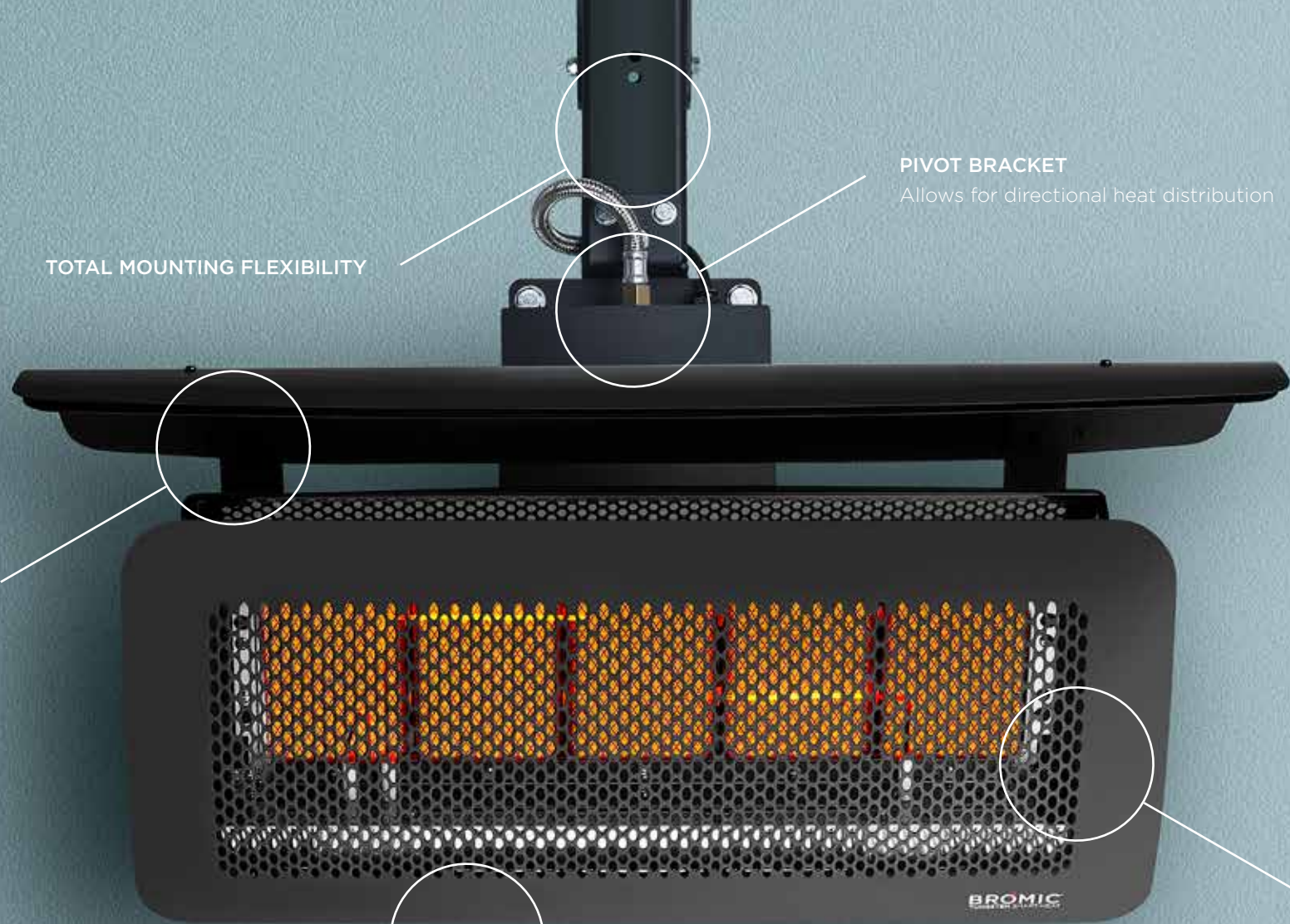

**TOTAL MOUNTING FLEXIBILITY**

**PIVOT BRACKET**  
Allows for directional heat distribution

**PATENTED PERFORMANCE**  
Superior wind resistance

**UNIQUE DESIGN**  
Honeycomb fascia enables precise heat distribution

**HIGH PERFORMANCE CONSTRUCTION**  
Matte black stainless-steel body

**BROMIC.COM/HEAT**

ASIA PACIFIC | NORTH AMERICA | EUROPE

Bromic pursues a policy of continuing improvement in design and performance of its products. The right is therefore reserved to vary specifications without notice.