



IR ENERGY INC.
 563 BARTON STREET
 STONEY CREEK, ON L8E 5S1
 PHONE: (905) 664-9082
 www.irenergy.ca

SELECT DESIRED GAS:

- NATURAL GAS
- PROPANE

SELECT DESIRED FINISH:

- 304 STAINLESS STEEL
- BLACK POWDER COAT
- CUSTOM POWDER COAT SPECIFY: _____

OPTIONAL GAS CONNECTION COVER
HEAT COVERAGE

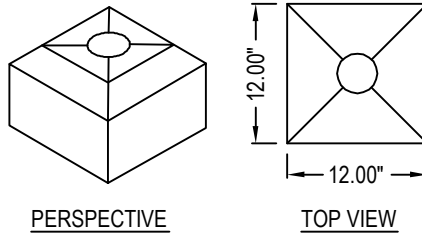

PERSPECTIVE

TOP VIEW

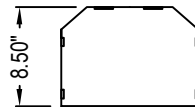

FRONT & SIDE
ELEVATION

TECHNICAL SPECIFICATIONS:

- HIGH FIRE - 53,000BTU/HR (NG)
47,000BTU/HR (LPG)
- LOW FIRE - 46,000BTU/HR (NG)
40,000BTU/HR (LPG)
- MANIFOLD PRESSURE: NG -
5.5" W.C. (HI), 4.0" W.C. (LO) | LPG -
9.8" W.C. (HI), 7.0" W.C. (LO)
- GAS SUPPLY PRESSURE: NG -
6.5" W.C. (MIN), 14.0" W.C. (MAX) |
LPG: 11.0" W.C. (MIN), 14.0" W.C.
(MAX)
- ELECTRICAL SUPPLY: 24 VOLTS, 0.8
AMPS
- DIRECT SPARK IGNITION WITH
3-TRY LOCK OUT & AUTOMATIC
RE-LIGHT

WARRANTY:

- 3 YEARS ON 316 STAINLESS STEEL
EMITTER
- 1 YEAR ON ALL OTHER PARTS

NOTES:

1. INSTALLATION TO BE COMPLETED IN ACCORDANCE WITH MANUFACTURER'S SPECIFICATIONS.
2. DO NOT SCALE DRAWING.
3. THIS DRAWING IS INTENDED FOR USE BY ARCHITECTS, ENGINEERS, CONTRACTORS, CONSULTANTS AND DESIGN PROFESSIONALS FOR PLANNING PURPOSES ONLY. THIS DRAWING MAY NOT BE USED FOR CONSTRUCTION.
4. ALL INFORMATION CONTAINED HEREIN WAS CURRENT AT THE TIME OF DEVELOPMENT BUT MUST BE REVIEWED AND APPROVED BY THE PRODUCT MANUFACTURER TO BE CONSIDERED ACCURATE.
5. CONTRACTOR'S NOTE: FOR PRODUCT AND COMPANY INFORMATION VISIT www.CADdetails.com/info AND ENTER REFERENCE NUMBER 5029-005.

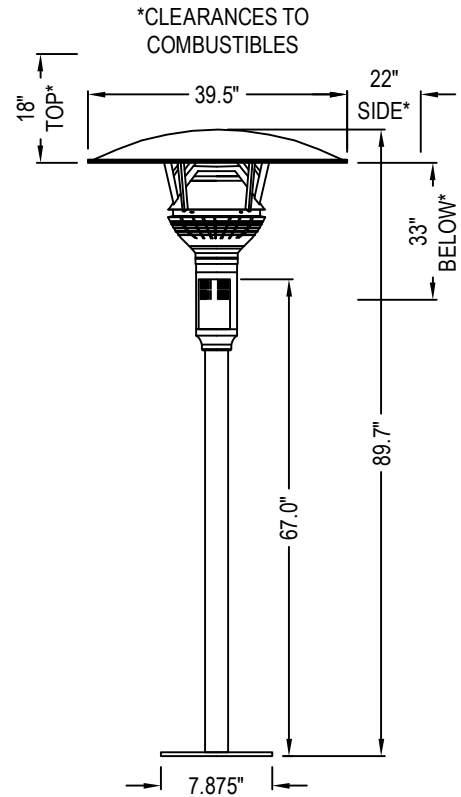

FRONT ELEVATION -MODEL GA301

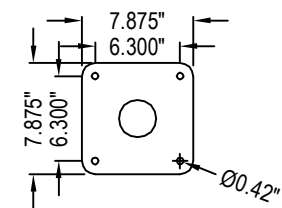

BOTTOM MOUNTING PLATE

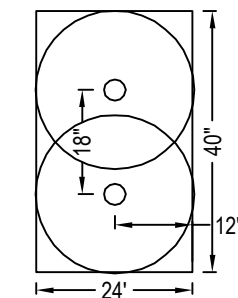

TYPICAL COVERAGE
TWO HEATERS

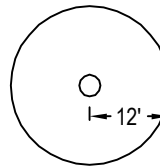

TYPICAL COVERAGE
ONE HEATER

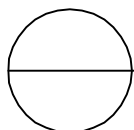

EVENFLO

EVENFLO FIXED SERIES: MODEL GA301