

# 33" Electric Firebox

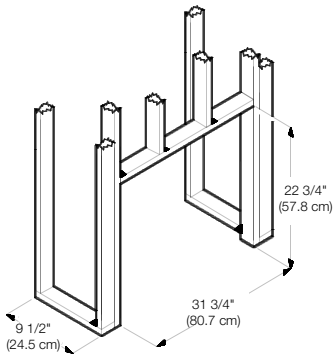











### Framing Dimensions



120 V / 1,000 W / 3,415 BTU

Model #	Description	Lbs / Kg	UPC	Carton Dimensions (WxHxD)		Cube	
				Inches	cm	ft <sup>3</sup>	m <sup>3</sup>
DFG3033	33" self-trimming widescreen electric firebox with glass ember bed	60.4 / 27.5	781052 061316	37.3 x 27.6 x 13	94.6 x 70.1 x 33	7.7	0.22

## Features

- 
**Flame**  
 A blend of technology, artistry and craftsmanship – the patented Dimplex flame technology creates the illusion of a true fire.
- 
**LED Technology**  
 Lasts more than 35 times longer and uses 10 times less energy than incandescent light bulbs.
- 
**Supplemental Heat**  
 Includes a powerful fan-forced heater designed to keep the rooms you spend the most time in warm and comfortable. Reduce your central furnace temperature and cut your heating costs!
- 
**Thermostat**  
 Includes a thermostat controlled fan-forced heater to ensure consistent comfort.
- 
**Remote**  
 Includes a convenient on/off remote for ease of use at your fingertips.
- 
**Year-round Enjoyment**  
 Enjoy the ambiance of the flame with or without the heater for year-round enjoyment.
- 
**Economical**  
 Economical to operate. Costing only pennies per hour.\*
- 
**Green**  
 The green alternative. No harmful particulates or emissions and 100% efficient. Produces 90% less carbon dioxide than an average direct vent gas fireplace.
- 
**Safe**  
 Front glass stays cool, making it safe to touch.
- 
**Instant Ambiance**  
 Plugs into any standard household outlet.

\* Based on national average residential electricity rate. Rates vary.