

# DRD Series

Modular Downlighting System

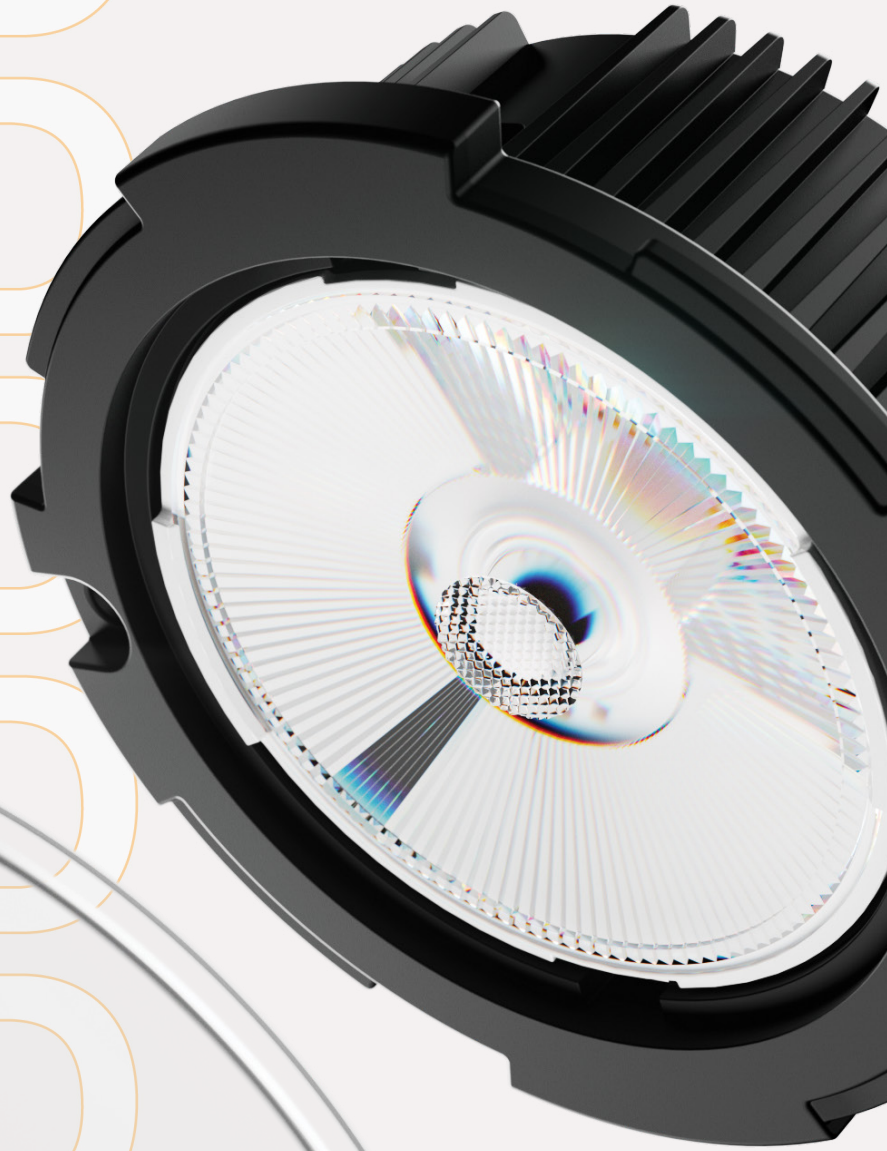



## **We've stayed up for hours so you don't have to**

DMF's upgraded DRD Series modular downlighting system, powered by the next generation DRD2 and DRD4, now hits every lighting spec you may come across – fixed, adjustable or wall wash, round or square, 750 to 1500 lumens. This versatile solution with integrated TRIAC/ELV and 0-10V drivers can keep up with the fast-paced and ever-changing nature of your projects.

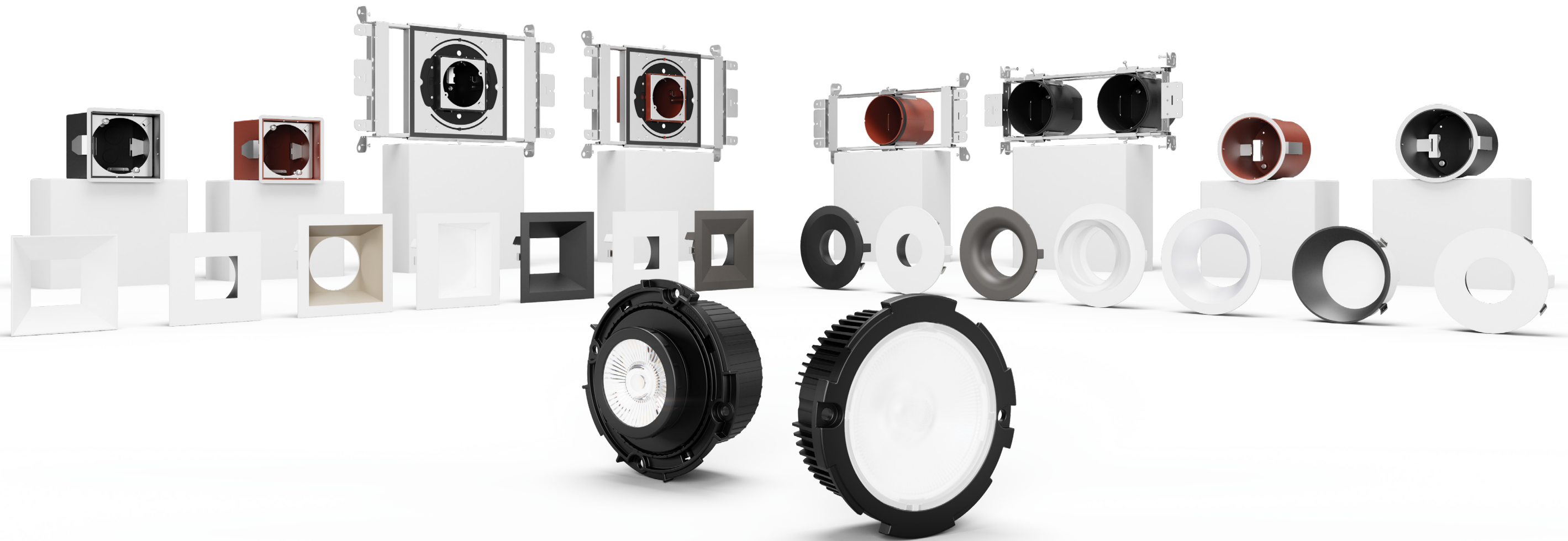

## One solution for every fixture type

The next generation DRD Series is engineered for ultimate flexibility. Our modular solution offers a range of color temperatures, field-changeable beam angles from 15 to 90+ degrees, 120/277 voltage regulation, and 1% dimming with TRIAC/ELV or 0-10V, all integrated into the module. A single housing can accommodate 98% of downlighting use cases – fixed, adjustable, to wall wash, we have you covered. Standardize on DRD and write fixture schedules with ease.

The DRD Series can support 98% of recessed lighting use cases.

## M Series 4" Round & Square Housing

The all-new M Series is designed to adapt. Building on our award-winning OneFrame platform, the M Series offers even more housing rating options, including Standard, Fire-Rated, and Chicago Plenum, along with specialty options such as Low-Profile and Double Housing. The compact, 4" housing installs easily and precisely for optimal fixture placement in crowded plenum space, to accommodate ductwork, framing, and plumbing.

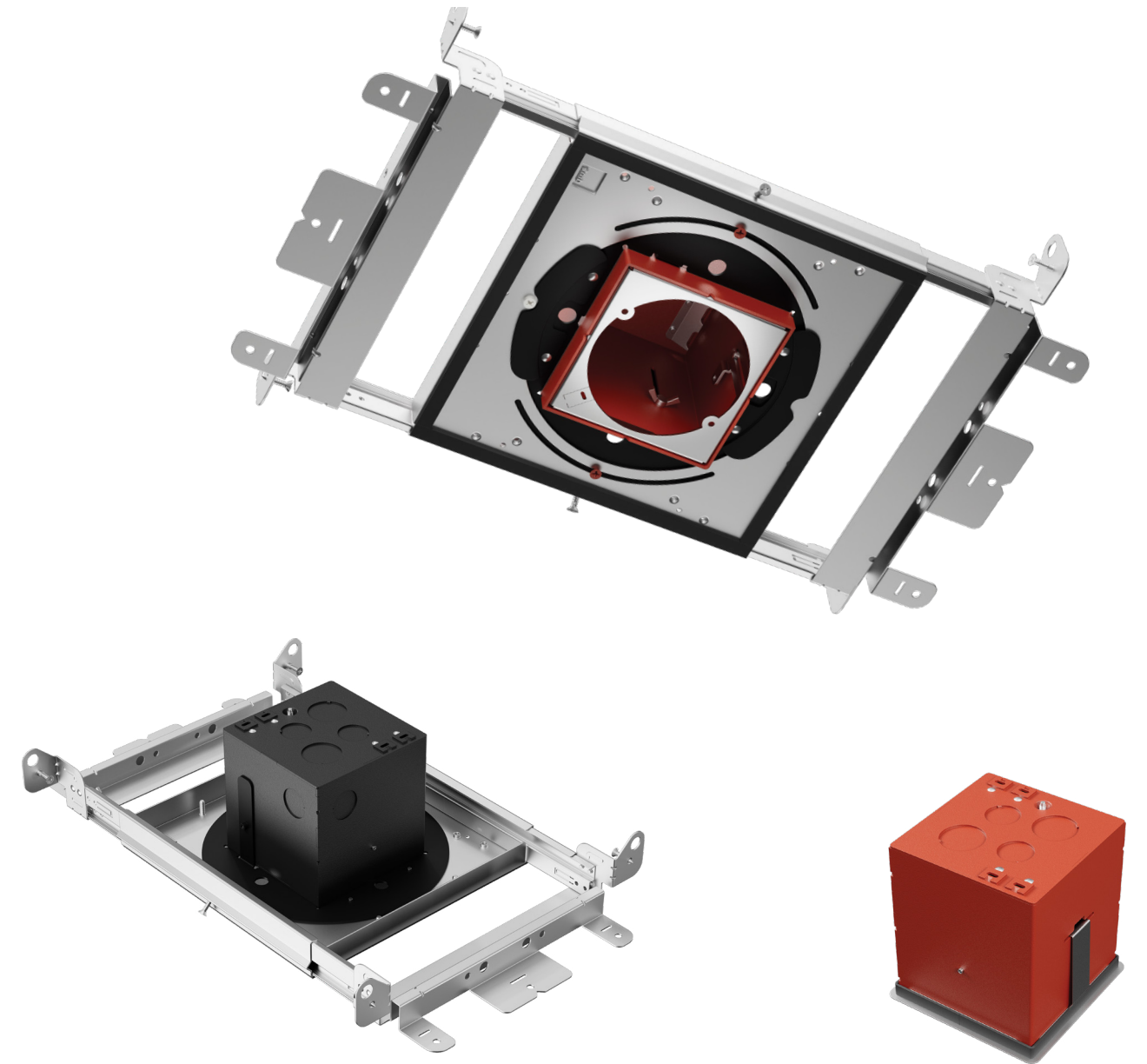
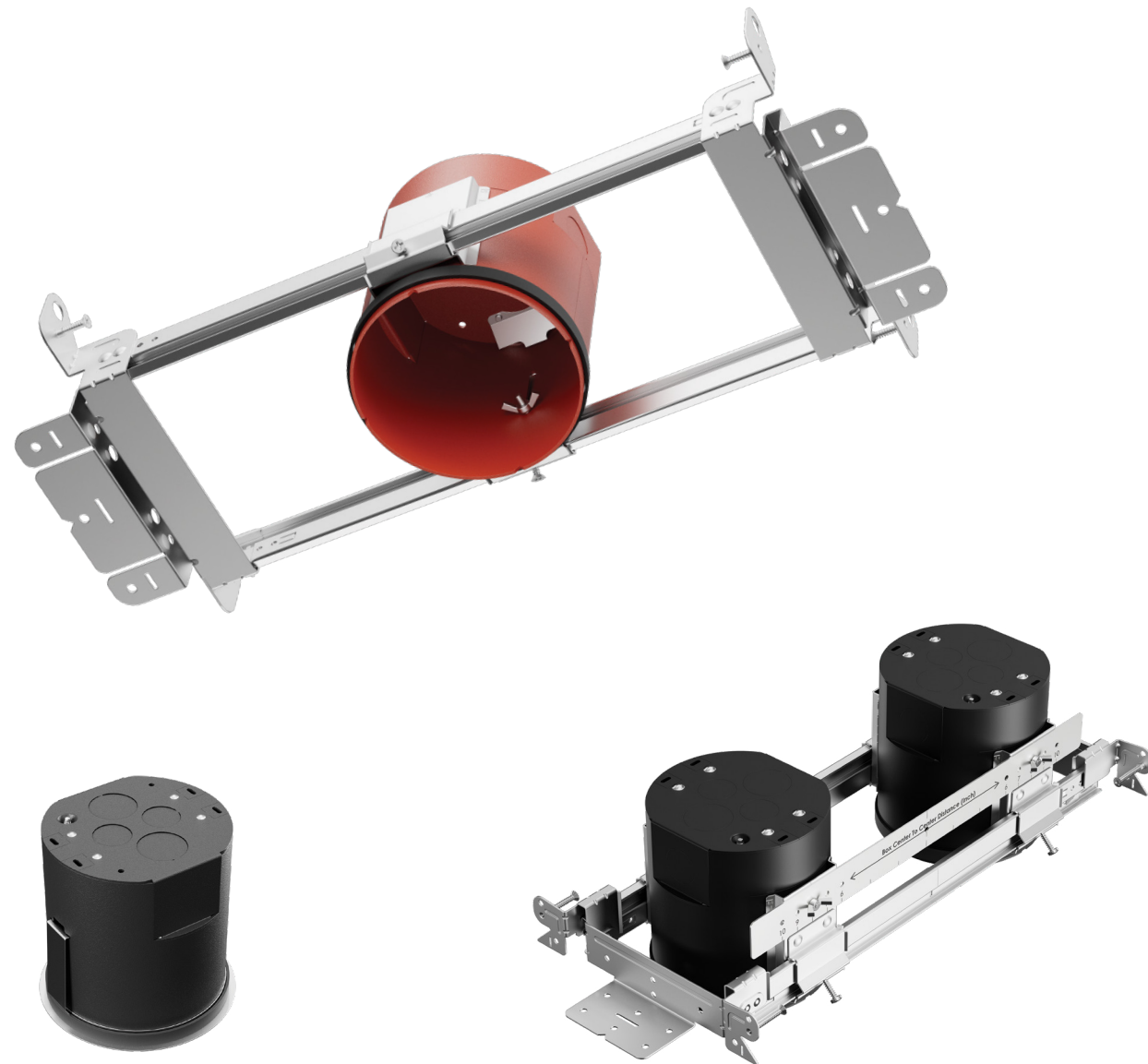

With the all-new M Series, the DRD Series is now more versatile than ever.

Bar hangers easily lock into place with a screwdriver to stay rigid even when extended to 24"







Indents for laser or string alignment





4" shallow housing with tool-free depth adjustment for ceilings thickness from 1/2" to 1 3/4"

Numerous connection points to install into hat channel, T-bar, C channel, wood joist, Quick-Span, I-Beam

## Eliminate planning headaches

Keep up with the fast-paced and ever-changing nature of your business with the all-new M Series housings. Comply with almost any building code you may come across – the system is compliant with JA8 Title 24, FCC, and UL, and is rated for installation in IC, Air-Tight, wet and damp locations. Additionally, the Series is Declare Listed for Living Building Challenge and LEED projects, and is Fire, STC/IIC Sound and IK10 Impact Rated.

-  Chicago Plenum
-  Concrete Construction
-  STC/IIC Sound Rated
-  ASTM Certified Air Tight
-  Insulation Contact (IC) Rated

-  2-Hour Fire Rated
-  IK10 Rated
-  Damp Location
-  Wet Location
-  Emergency





## Change orders? No problem

Make modifications without ripping open the ceiling – the modular DRD Series makes redesign a breeze. Swapping from fixed to adjustable is as easy as changing a lightbulb – quick connects make this solution plug and play. The modules feature lumen packages from 750 to 1500 and tool-free, field-changeable optics from 15 to 90+ degrees – easily handle any design changes, even post-installation.

Our precision-crafted aluminum trims meet the design aesthetic of any project – wall wash, pinhole, round, square, and flangeless. New standard finishes, including bronze, clear diffuse, and warm diffuse, expand their versatility even further. Like the modules, the trims are completely interchangeable.





## Bulletproof design & reliability

DMF's driver, heat sink, and the LED chip are all integrated into the module. They feature built in voltage regulation, thermal and surge protection. Components are designed in-house by our team of engineers to ensure flawless integration and optimal performance. This streamlined design simplifies installation, maintenance and troubleshooting.

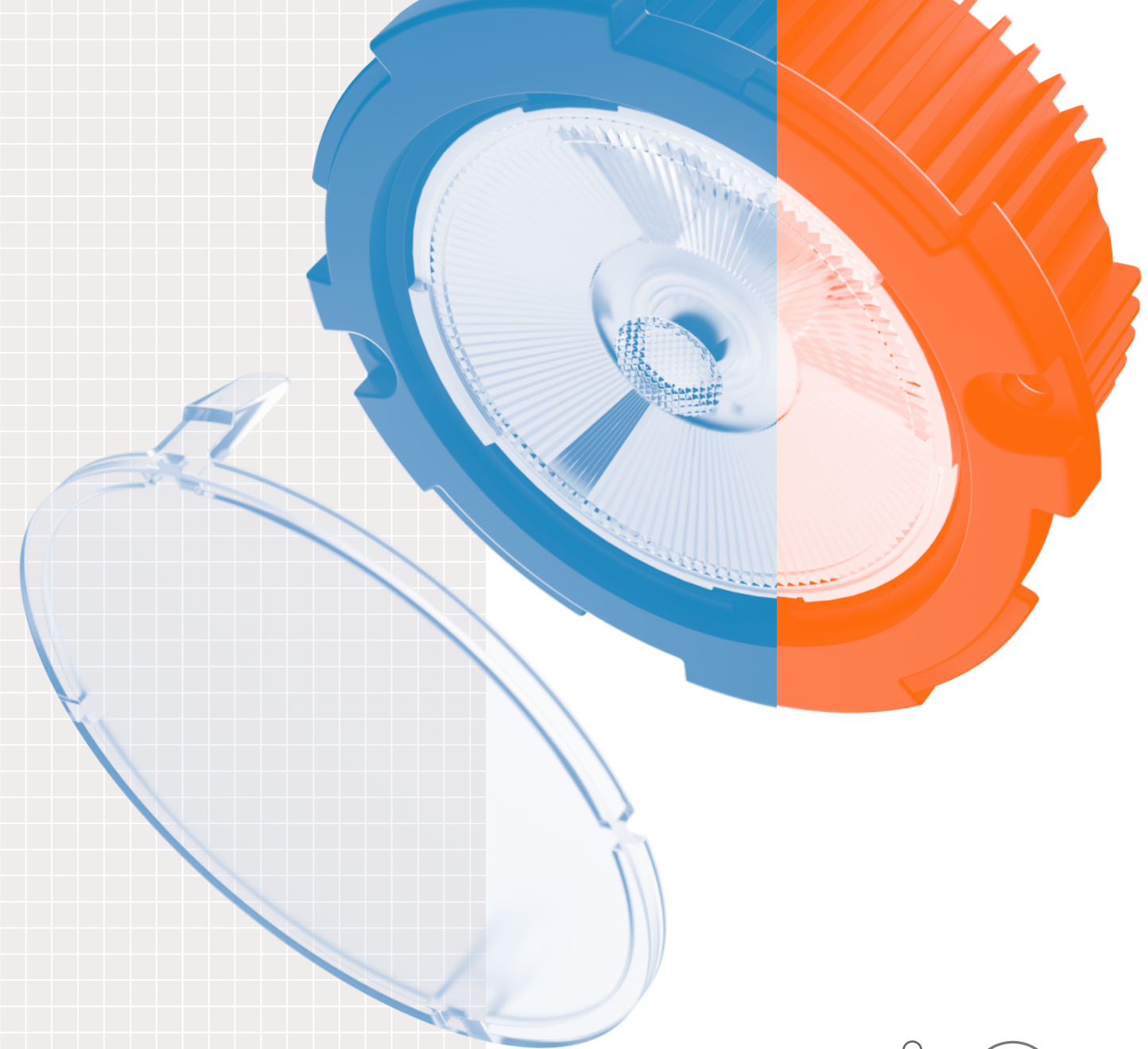

To ensure maximum reliability, we put the DRD Series to the test. The modules endure surge spikes up to 17x standard voltage and are run in a continuous ambient environment of 44° C (113° F) for over 10,000 hours to exceed the LM-84 standard. This high level of stress tests ensures DMF fixtures exceed our 50,000-hour guarantee.

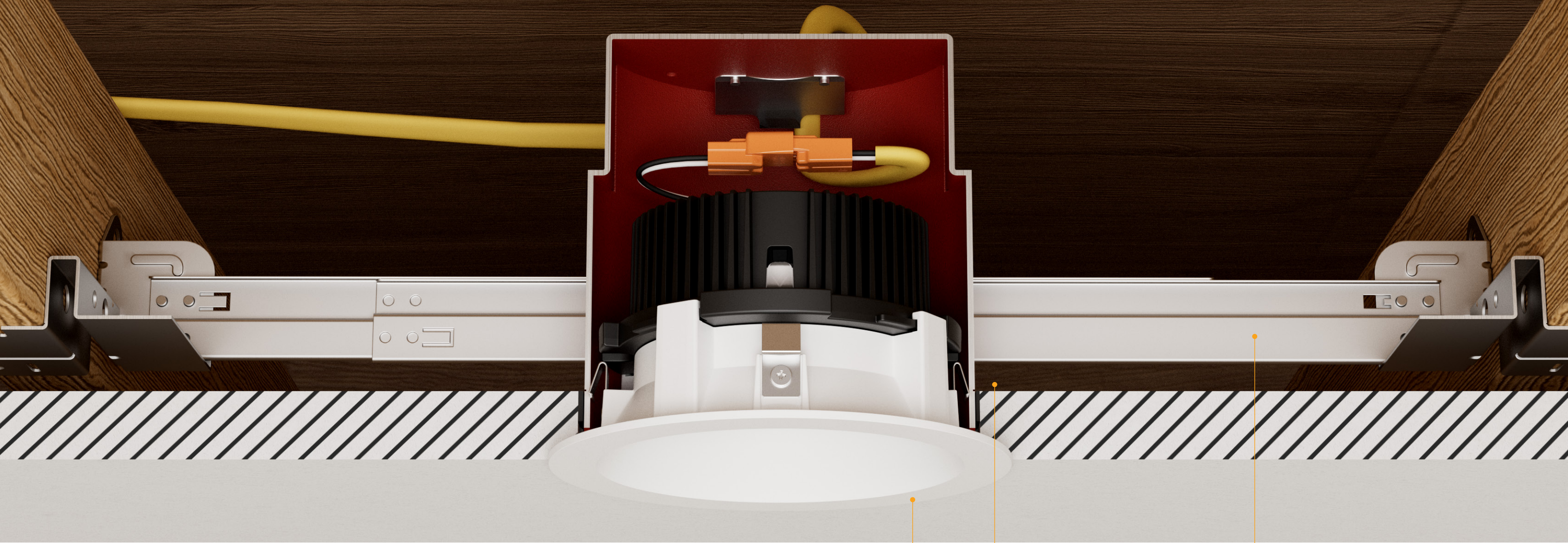

Adjustable housing depth for flush trim installation in ceilings ½" - 1¾" thick

Patented reinforced bar hangers prevent trim sag

Patented Twist & Lock Technology creates a secure connection

## Say goodbye to light leak and saggy trims

We have engineered this system to make light leak a thing of the past. The patented bar hangers have been reinforced to prevent against trim sag, even when fully extended. The housing offers depth adjustment for ceiling thicknesses from ½" to 1¾" allowing for flush trim installation. These features, paired with our precision crafted trims and patented Twist & Lock Technology, create a secure connection between the trim and the module – light has nowhere to escape.





## Stay ahead of ever-changing project timelines

Extend your decision-making timeline with the adaptability of our DRD Series. The modularity of the system allows housings and light modules to ship separately, so housings can install before the lighting design is finalized. Maintain tight project timelines, reduce on-site storage requirements, and extend product warranties start times until the modules ship. Our advanced warehousing allows for items to ship quickly. Get the exact product you need when you need it.

## Service first

DMF offers transparent pricing, module specific BIM and IES files, installation videos, and access to the engineers that built your product. We stand behind our products at every stage of the project: planning, installation, and maintenance.

The new DRD Series is the day in, day out downlight you can depend on.





## DRD2

Fixed Downlight

## DRD4

Adjustable Downlight

	DRD2 Fixed Downlight	DRD4 Adjustable Downlight
<b>APPLICATION</b>	New Construction, Remodel, Retrofit	New Construction, Remodel, Retrofit
<b>HOUSING</b>	M Series; SurfaceFrame; Classic Frame: 4", 5", 6", 8"; Cylinder	M Series; Classic Frame: 4", 5", 6"; Cylinder
<b>ADJUSTMENT</b>	–	360° directional aim, 45° tilt
<b>DELIVERED LUMENS</b>	750 lm (9.5W), 1000 lm (12.5W), 1250 lm (14W), 1500 lm (17.5W)	750 lm (9.7W), 1000 lm (12W)
<b>COLOR QUALITY</b>	93+ CRI, 2-step SDCM	93+ CRI, 2-step SDCM
<b>COLOR TEMPERATURE</b>	2700K, 3000K, 3500K, 4000K	2700K, 3000K, 3500K, 4000K
<b>WARM DIM</b>	3000K–1800K	3000K–1800K
<b>BEAM SPREAD</b>	15° Narrow Spot, 25° Spot, 40° Flood, 60° Wide Flood, 90°+ General Ambient, 40° x 20° Linear Spread, Soft Focus	15° Narrow Spot, 25° Spot, 40° Flood, 60° x 30° Linear Spread, Soft Focus
<b>OPTIONS</b>	–	Black, White Surround
<b>INPUT VOLTAGE</b>	120/277V	120/277V
<b>1% DIMMING</b>	TRIAC/ELV, 0-10V, Lutron EcoSystem	TRIAC/ELV, 0-10V, Lutron EcoSystem
<b>STANDARDS</b>	JA8 Title 24, UL certified, ENERGY STAR®, Declare	JA8 Title 24, UL certified, ENERGY STAR®, Declare
<b>RATINGS</b>	Wet location	Damp location
<b>LIFETIME (L70)</b>	50,000 hrs	50,000 hrs
<b>WARRANTY</b>	5 years	5 years

# Brilliance engineered



Our in-house R&D lab is filled with brilliant engineers always at work improving our products and inventing new ones. They understand that light is more than illumination, it's what makes a space beautiful, useful, and ultimately, enjoyable.

DMF engineers create products that deliver exceptional performance and aesthetics, while also saving you time and money year after year. That same ethos animates every part of our company, from our tireless customer service to our fast, intelligent distribution.

If you want lighting that's not just built better, but built smarter, DMF is the lighting partner for you.

## DMF Lighting

1118 East 223<sup>rd</sup> Street,  
Carson, CA 90745  
323.934.7779  
info@dmflighting.com  
[dmflighting.com](http://dmflighting.com)

