



Electronic Preset Meter 2 Standard Series

Model EPM2-STD Plus



AUT-UM-00933-EN-04 (May 2014)

User Manual

CONTENTS

| | |
|--|----|
| Safety | 4 |
| Meter Buttons | 5 |
| LCD Display | 5 |
| Meter Installation | 6 |
| Relieve System Pressure | 6 |
| Grounding | 6 |
| Flushing Procedure | 6 |
| Attach Meter to Hose | 6 |
| Attach Nozzle to Meter | 7 |
| Meter Operation | 8 |
| Manual Mode | 8 |
| Auto Batch Mode | 8 |
| Operating Mode Functions | 9 |
| Re-settable and Accumulated Totals | 9 |
| Emergency Override | 9 |
| Error Codes | 9 |
| Service | 10 |
| Low Battery | 10 |
| Changing the Batteries | 10 |
| Change Factory Settings | 10 |
| Verify Firmware Version | 10 |
| Programming | 10 |
| Change Unit of Measure | 11 |
| Change Scale Factor | 11 |
| Save Changes | 12 |
| Verify Changes | 12 |
| Calculate Scale Factor | 12 |
| Absolute Scale Factor | 12 |
| Chart of Approximate Scale Factors | 13 |
| Dimensions | 13 |
| Specifications | 14 |
| Troubleshooting | 16 |

SAFETY

⚠ WARNING

IMPROPER GROUNDING, POOR VENTILATION, OPEN FLAMES OR SPARKS CAN CAUSE A HAZARDOUS CONDITION AND RESULT IN AN EXPLOSION OR FIRE AND CAUSE SERIOUS INJURY.

- Be sure the fluid system is properly grounded. See your pump instruction manual for details.
- If there is static sparking or if you feel an electric shock while using the meter, stop dispensing immediately. Identify and correct the problem before continuing.
- Provide fresh air ventilation. This will avoid the buildup of fumes from the fluid being dispensed.
- Do not smoke while dispensing flammable fluids.
- Keep the dispensing area free of debris including solvents, rags and spilled gasoline.

⚠ WARNING

EQUIPMENT MISUSE CAN CAUSE THE METER TO RUPTURE OR MALFUNCTION AND CAUSE SERIOUS INJURY.

- This equipment is for professional use only.
- Read all instructions, tags and labels before operating the equipment.
- Use the equipment only for its intended purpose.
- Do not modify or alter the equipment.
- Do not leave equipment unattended while dispensing.
- Check equipment daily. Repair or replace worn or damaged parts immediately.
- Do not exceed the maximum working pressure level of the lowest rated system component.
- Use only extensions and nozzles that are designed for use with this equipment.
- Use only fluids and solvents that are compatible with the equipment. Read all fluid and solvent manufacturer's warnings.
- Tighten all fluid connections before operating this equipment.
- Do not stop or deflect leaks with hands, body, gloves or rags.
- Do not dispense towards any person or any part of the body.
- Do not place hands or fingers over the end of or into the dispense valve.
- Comply with all local, state, and federal fire, electrical and safety regulations
- Use of this product in a manner other than specified in this manual may result in impaired operation or damage to equipment.

⚠ WARNING

THIS METER IS DESIGNED SPECIFICALLY TO DISPENSE PETROLEUM PRODUCTS. DO NOT USE FOR ANTIFREEZE (ETHYLENE GLYCOL) SOLUTION, WINDSHIELD WIPER FLUID, BRAKE FLUID AND WATER BASED SOLUTIONS

METER BUTTONS

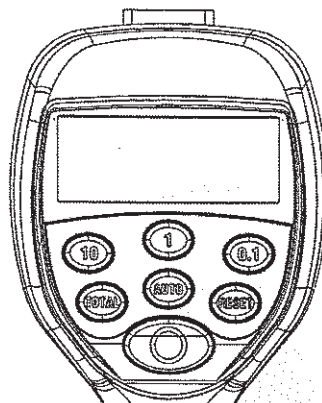

Figure 1: Meter button location

| | |
|--|---|
| | Used to enter the batch quantity to be dispensed. |
| | Used to display the accumulated total of fluid dispensed as well as the re-settable total during <i>Auto Batch</i> and <i>Manual Mode</i> . |
| | Used to enter and exit the <i>Manual</i> or <i>Auto Batch</i> mode. |
| | <ul style="list-style-type: none"> Used in the <i>Manual</i> mode to clear the dispensed quantity. Used in the <i>Auto Batch</i> mode to clear the dispensed quantity and reset the meter for the next batch. Used to reset the re-settable total dispensed while pressing the TOTAL button. |
| | Used to stop the flow through an <i>Emergency Override</i> . |

Table 1: Button descriptions

LCD DISPLAY

| | |
|--|---|
| | 1. Displays <i>Re-settable Total</i> , <i>Accumulated Total</i> and <i>Scale Factor</i> . |
| | 2. Displays <i>Unit of Measure</i> . |
| | 3. Arrow- not used. |
| | 4. Preset batch quantity. |
| | 5. History icon- not used. |
| | 6. Auto is an indicator of unit being in <i>Auto Batch Mode</i> . |
| | 7. Low battery icon. |

Table 2: LCD display description

METER INSTALLATION

Relieve System Pressure

⚠ WARNING

THIS EQUIPMENT STAYS PRESSURIZED UNTIL THE PRESSURE IS MANUALLY RELIEVED.

1. Turn off the power supply to the pump or close the shutoff valve.
 2. Dispense any fluid in the system into a waste container by opening the meter.
 3. Open all bleed-type master air valves and fluid meter in the system.
 4. Leave the meter open until ready to pressurize the system.
- To reduce the risk of injury from fluid spray from the meter, follow this procedure when you:

- Are instructed to relieve pressure.
- Stop dispensing.
- Check, clean or service any system equipment.
- Clean or install nozzles.

Grounding

⚠ WARNING

MOVEMENT OF FLUIDS THROUGH THE DISPENSING SYSTEM CREATES STATIC ELECTRICITY. STATIC ELECTRICITY CAN CAUSE VOLATILE FUMES RESULTING IN AN EXPLOSION AND FIRE. THE DISPENSING SYSTEM MUST BE GROUNDED.

Grounding reduces the risk of static sparking. Ground all system components according to local, state and federal codes. Consult the pump user manual and other system components to ground the following:

1. Pump: follow manufacturer's recommendations
2. Air and Fluid Hoses: use only grounded hoses Air Compressor: follow manufacturers recommendations
3. Fluid Supply Container: follow the local code

Flushing Procedure

⚠ CAUTION

IF THIS INSTALLATION IS NEW OR IF THE FLUID IN THE LINES IS CONTAMINATED, FLUSH THE SYSTEM BEFORE INSTALLING THE METER(S).

NOTE: If the system has multiple dispense positions, begin at the position farthest from the pump and move towards the pump.

1. Close fluid dispense valves at every position.
2. Once the main fluid outlet valve at the pump is closed and the air pressure to the pump motor is properly adjusted, the air valve is opened.
3. Slowly open the main fluid valve.
4. Place the hose end in a waste container. Make sure the hose is secure so no fluid leaks during flushing.
5. Slowly open the dispense valve and allow enough fluid to pass through it to ensure that the system is clean.
6. Close the valve and repeat for all dispense positions.

Attach Meter to Hose

Close the drain valve before starting this procedure.

1. Attach swivel to meter. Apply thread sealant to the male end of the hose. Recommended sealant is Loctite® 243. See *Figure 2*.



Figure 2: Apply thread sealant

2. Insert the metal end of the hose into the swivel. See *Figure 3*.



Figure 3: Insert hose into swivel

3. Tighten completely with an open ended, adjustable, wrench. See *Figure 4*.

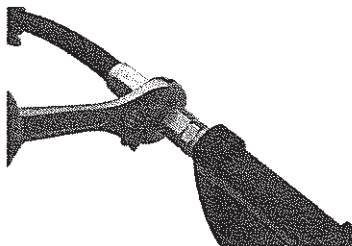

Figure 4: Use wrench to tighten

NOTE: The threaded end of the meter always has female threads. The metal end of the hose must have male threads. The inlet and outlet swivel connections are either 1/2" NPT or 1/2" BSPP, depending on meter model.

Attach Nozzle to Meter

1. On the opposite end, apply sealant to the end of the nozzle. Recommended sealant is Loctite® 243.
2. Thread the nozzle onto the meter. See *Figure 5*.

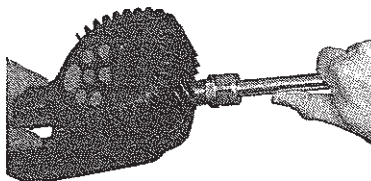

Figure 5: Thread nozzle onto meter

3. Screw it in tightly with an open-ended, adjustable, wrench. See *Figure 6*.

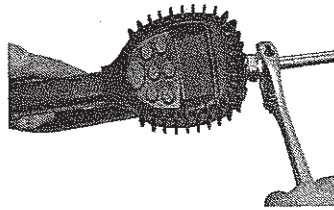

Figure 6: Tighten nozzle with wrench

4. Open all dispense position shut-off valves. Start the pump to pressurize the system.
5. Before use, to ensure accuracy, purge all air from the fluid lines and dispense valve(s).

METER OPERATION

NOTE: The keypad Auto button is used to toggle between *Manual Mode* and *Auto Batch Mode*.

Manual Mode

In *Manual Mode* the meter operates as a free flow-dispensing handle.



Figure 7: Manual mode screen

1. Pull the trigger to begin the flow.
2. The display shows the amount dispensed.
3. When the desired amount has been dispensed, release the trigger to stop the flow.
4. Press **RESET** once to reset the counter display to zero.

Auto Batch Mode

To enter *Auto Batch Mode* from *Manual Mode* press **AUTO**. When in *Auto Batch Mode*, the *Auto* icon displays and the batch quantity shows in the lower right hand LCD display.

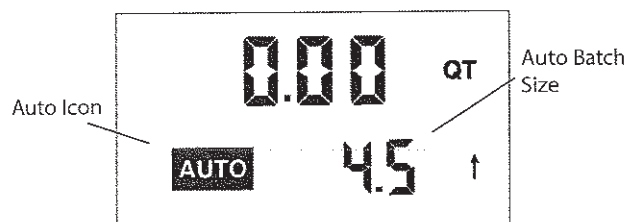

Figure 8: Auto batch mode display

1. Change the batch size by pressing **10**, **1**, and **0.1**.
 - a. Press **10** to increase the batch amount in increments of 10 units.
 - b. Press **1** to increase the batch amount in increments of 1 unit.
 - c. Press **0.1** button to increase the batch amount in increments of 0.1 units.
2. Pull the trigger to begin the flow. The solenoid valve, in the meter, automatically locks the dispensing valve in the full open position.
3. Release the trigger, allowing it to fall back.
4. The flow automatically shuts off after the batch quantity has dispensed.

5. After the batch quantity has been dispensed the meter is a free flow-dispensing handle until the reset button is depressed.
 - a. To top off the fluid, pull the trigger to being the flow and release it when the correct amount has been pumped.
- NOTE:** In case of an emergency or to interrupt a batch, the meter is equipped with an *Emergency Override*. See "*Emergency Override*"
6. Press RESET when finished. The display resets and the meter is now ready for the next batch to be dispensed.

OPERATING MODE FUNCTIONS

These functions operate the same in Manual Mode and Auto Batch Mode.

Re-settable and Accumulated Totals

The meter has two flow totalizers, *Re-settable Total* and *Accumulated Total*.

1. Press and hold **TOTAL** to display *Accumulated Total*, after holding for three seconds the display changes to *Re-settable Total*.
2. Resettotal displays the total fluid dispensed since the Re-settable Total was last set back to zero.



Figure 9: Re-settable total display

3. Press **RESET** while viewing Resettotal to set it back to zero.
4. Release **TOTAL** to return to the operating screen.

NOTE: The *Accumulated Total* cannot be reset unless the user changes from English units to metric units or from metric to English units. See "*Change Unit of Measure*" on page 11.

Emergency Override

In case of an emergency or to interrupt a batch, the meter is equipped with an *Emergency Override* which closes the valve, immediately stopping fluid flow.

1. Press **O** to activate the *Emergency Override*.
2. After an *Emergency Override*, batching can continue by pulling up on the trigger.

Error Codes

The meter has one error code that may display:

SF0 (Scale Factor 0) The Scale Factor setting for the meter is set to 0.000.

The code provides an indication, at the meter, that there is an error in communication between the meter and keypad. To correct the error, input a valid Scale Factor for the meter follow the instructions in "*Change Scale Factor*" on page 11. All other error codes are for factory purposes only. To clear the meter, press **RESET**.

SERVICE

Low Battery

When the batteries need to be changed a progression of warnings appears on the meter screen. First, the *Low Battery* icon will appear on the display, this means that the batteries are getting low, and should be changed. When the icon begins to flash, the battery power is too low, and meter functions are disabled.

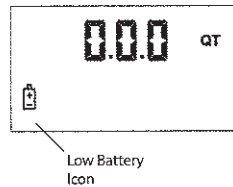

Figure 10: Low battery icon

Changing the Batteries

The battery compartment is located in the lower case on the underside of the trigger guard.

1. Turn the unit over.
2. Unscrew the two screws. Remove the battery door to expose the batteries.

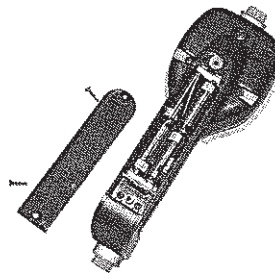

Figure 11: Replacing the batteries

3. Replace the old batteries. The meter takes four AA, alkaline, batteries. Battery polarity markings are inside the battery compartment.
4. Dispose of used batteries properly, according to local regulations.

NOTE: Changing the batteries does not affect any of the programmed values or totals.

CHANGE FACTORY SETTINGS

Each meter is calibrated at the factory for use with motor oil. See "Change Scale Factor" on page 11 The *Unit of Measure* is also selected prior to shipment.

Verify Firmware Version

The firmware version and code checksum are displayed by pressing and holding **TOTAL** and **1** simultaneously. The last two digits on the lower right are the firmware version. Meters with version 16 or higher use the procedure outlined in this manual for changing the unit of measure, scale factor and enabling or disabling the EPM functionality.

Programming

1. Press and hold **TOTAL** and **AUTO** simultaneously. PrG will appear on the display.

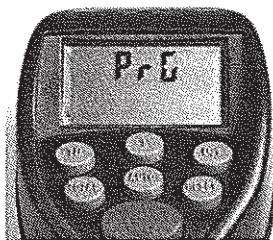

Figure 12: Entering programming mode

2. Release the buttons.
3. Press and release these buttons in order: **1**, **AUTO**, **10**, **0.1**, and **TOTAL**.
4. The current unit of measure will now be flashing indicating that you have entered the programming mode.

Change Unit of Measure

The meter comes with an option to choose four different units of measure.

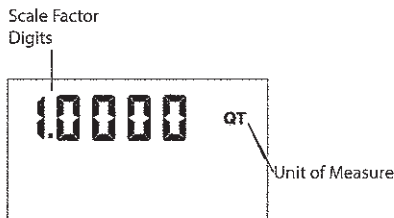

Figure 13: Unit of measure display

1. The current unit of measure will flash when *Programming Mode* is entered.
2. Press **TOTAL** to toggle amongst the four options; PT, QT, GAL, L.
3. When the correct unit of measure is displayed, press **RESET** to select it. The unit of measure will stop flashing.
4. If L (liters) is selected, the decimal point will be flashing. The decimal point can either be changed to a comma or a period. To do this press **TOTAL**.
5. If no scale factor changes are necessary, see "*Save Changes*" on page 12.

⚠ CAUTION

CHANGING THE UNIT OF MEASUREMENT FROM METRIC TO ENGLISH OR FROM ENGLISH TO METRIC CLEARS THE RE-SETTABLE TOTAL AND ACCUMULATED TOTAL.

Change Scale Factor

⚠ WARNING

CHANGING THE SCALE FACTOR CHANGES THE ACCURACY OF THE METER, POTENTIALLY CAUSING IT TO OVERFILL OR UNDER FILL. THIS HAS THE POTENTIAL TO CAUSE A MECHANICAL BREAKDOWN.

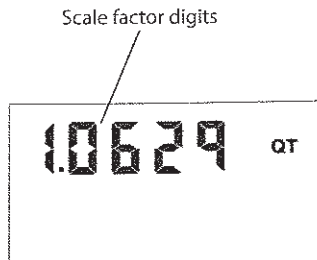

Figure 14: Scale factor display

1. Press **RESET** to advance through the scale factor digits.
 2. To change the selected number, press **TOTAL**.
- NOTE:** All digits can be scrolled between 0 and 9 except the first. It can only be scrolled from 0 to 1 or from 1 to 0.
3. Press **RESET** to advance to the next digit in the scale factor.
 4. Repeat steps 2 and 3 for all five digits.

Save Changes

To save changes and exit programming mode:

1. Press and hold **TOTAL** and **AUTO** simultaneously.
2. The display will flash three times and go blank.
3. Press **RESET** and the display will turn back on.

Verify Changes

1. Verify unit of measure is correct.
2. Press and hold **TOTAL** and **AUTO** simultaneously to verify the scale factor is correct.

CALCULATE SCALE FACTOR

A Scale Factor is a number used to adjust meter accuracy. The Scale Factor is set at the factory using motor oil with a viscosity of 10W. The primary use for Scale Factor recalibration is to batch fluids with different viscosities. If the fluid has a lower viscosity, more fluid can slip past the meter gears without being detected. Changing the Scale Factor adjusts the meter to compensate for the loss. The meter multiplies each pulse by the Scale Factor number to correct the accuracy when it converts to the specified units. For an approximate Scale Factor for fluids of different viscosities, see "Chart of Approximate Scale Factors" on page 13.

NOTE: The meter's original Scale Factor was written on the trigger when it was calibrated at the factory. It may have been revised after field installation. Use the Scale Factor showing on the display, not on the trigger.

⚠ WARNING

CHANGING THE SCALE FACTOR WILL CHANGE THE ACCURACY OF THE METER, POTENTIALLY CAUSING IT TO OVERFILL OR UNDER FILL. THIS HAS THE POTENTIAL TO CAUSE A MECHANICAL BREAKDOWN.

To view the current scale factor press and hold **TOTAL** and **AUTO** simultaneously.

Absolute Scale Factor

For absolute scale factor, perform this test:

1. Run a measured amount of fluid through the meter.
2. If the meter delivers 4.20 quarts and the display shows only 4.00 quarts, then the Scale Factor needs to be adjusted.
3. Divide what the meter delivered (4.20) by what the display shows (4.00). You get an error factor of (1.05).
4. The existing Scale Factor is 1.0123, as shown in steps 1 and 2 in "Verify Changes".
5. To calculate a new factor: $1.0123 \text{ (existing Scale Factor)} \times 1.05 \text{ (error factor)} = 1.0629 \text{ (new Scale Factor)}$.
6. Enter that number as described in the "Change Scale Factor" on page 11.

NOTE: Use the Scale Factor shown on the display, not on the trigger.

Chart of Approximate Scale Factors

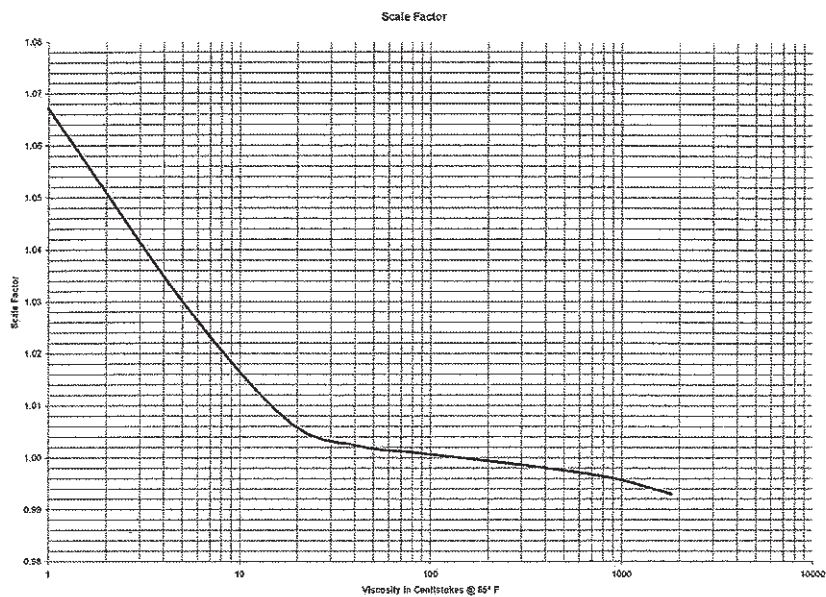

Figure 15: Scale factors for fluids with different viscosities

| Fluid | Viscosity | Scale Factor |
|-------------------|-----------|--------------|
| Water/anti-freeze | 5 | 1.044 |
| Anti-freeze | 18 | 1.007 |
| Brake Fluid | 42 | 1.004 |
| ATF | 80 | 1.002 |
| 10W | 140 | 1.000 |
| 80W-90 | 450 | 0.999 |
| 140W | 1800 | 0.993 |

Table 3: Fluid viscosity and scale factor

DIMENSIONS

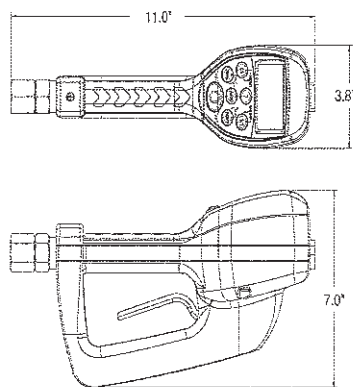

Figure 16: Meter dimensions

SPECIFICATIONS

| | |
|---|--------------------------------|
| Maximum flow * | 10 gpm (38 lpm) |
| Minimum flow * | 0.25 gpm (1 lpm) |
| Operating pressure (maximum) | 1000 psi (67 bar) |
| Operating pressure (minimum) | 5 psi (0.35 bar) |
| Operating temperature (maximum) | 120° F (50° C) |
| Operating temperature (minimum) | 20° F (-5° C) |
| Accuracy (general) | +/- 0.5% |
| Accuracy (anti-freeze) | +/- 1.5% |
| 5-digit LCD display | Quarts, Pints, Gallons, Liters |
| Inlet and outlet connections | 1/2" NPT (1/2" BSPP) |
| * Minimum and maximum flow range will vary with fluid viscosity | |

Table 4: Part numbers: inside meter

Parts

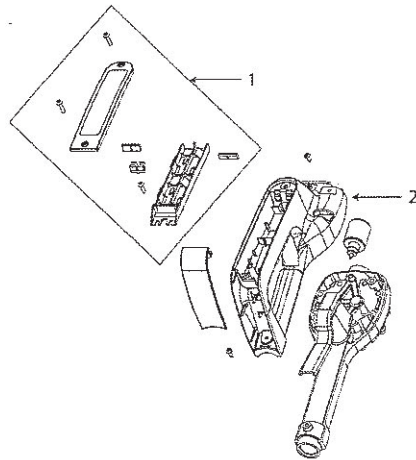

Figure 17: Parts: back of meter

| Item | Description | Part Number |
|------|-------------------------|-------------|
| 1 | Battery holder assembly | 64103-026 |
| 2 | Bottom case with screws | 64103-003 |

Table 5: Part numbers: back of meter

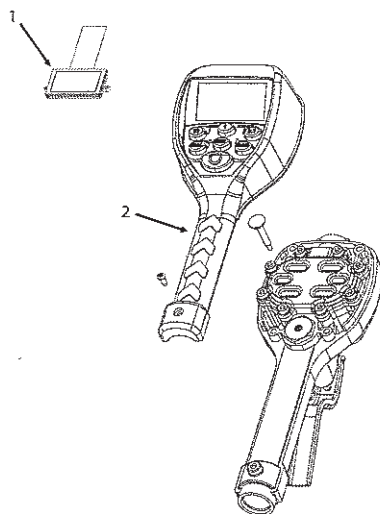

Figure 18: Parts: front of meter

| Item | Description | Part Number |
|-----------|-----------------------------|-------------|
| 1 | Display assembly | 64103-023 |
| 2 | EPM2 std. register assembly | 64103-024 |
| Not shown | Swivel, NPT, special fluids | 64082-001 |
| Not shown | Rubber boot | 65546-001 |

Table 6: Part numbers: front of meter

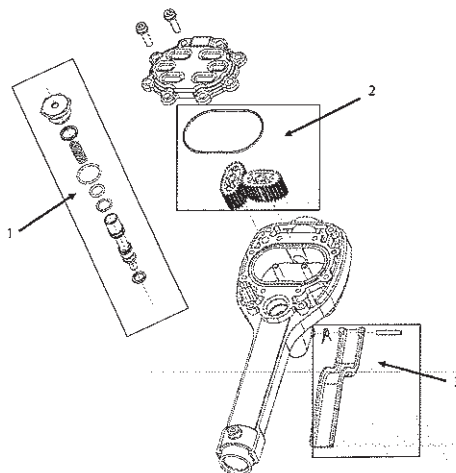

Figure 19: Parts: inside meter

| Item | Description | Part Number |
|------|------------------------------|-------------|
| 1 | Valve assembly | 64103-010 |
| 2 | Gear service kit with O-ring | 62896-001 |
| 3 | Trigger Assembly | 64103-005 |

Table 7: Part numbers: inside meter

TROUBLESHOOTING

⚠ WARNING

RELIEVE THE PRESSURE PRIOR TO CHECKING OR REPAIRING THE METER. MAKE SURE ALL VALVES, CONTROLS AND PUMPS ARE OPERATING CORRECTLY.

| Symptom | Possible Cause | Remedy |
|-----------------------------------|------------------------------------|---|
| Battery icon is displayed | Batteries are low | Replace batteries |
| Display blank | Meter asleep | Press RESET |
| | Loose battery connection | Remove battery pack and check battery connection / press RESET |
| | Batteries dead | Replace batteries / press RESET |
| Meter does not latch for batching | Meter not in AUTO mode | Press AUTO and program batch size |
| | Meter not reset after prior batch | Press RESET |
| | Low batteries | Check for battery icon / replace batteries / press RESET |
| Slow or no fluid flow | Filter is clogged | Clean or replace the filter in the swivel nut |
| | Pump pressure is low | Turn up the pump pressure |
| | Foreign material is jamming meter | Contact your local distributor for repair |
| Meter inaccurate | Scale factor not correct for fluid | Enter program mode, check and reset program factor |

Control. Manage. Optimize.

Trademarks appearing in this document are the property of their respective entities. Due to continuous research, product improvements and enhancements, Badger Meter reserves the right to change product or system specifications without notice, except to the extent an outstanding contractual obligation exists. © 2014 Badger Meter, Inc. All rights reserved.

www.badgermeter.com

The Americas | Badger Meter | 4545 West Brown Deer Rd | PO Box 245036 | Milwaukee, WI 53224-9536 | 800-876-3837 | 414-355-0400
 México | Badger Meter de las Americas, S.A. de C.V. | Pedro Luis Ogazón N°32 | Esq. Angelina N°24 | Colonia Guadalupe Inn | CP 01050 | México, DF | México | +52-55-5662-0882
 Europe, Middle East and Africa | Badger Meter Europa GmbH | Nürtinger Str 76 | 72639 Neuffen | Germany | +49-7025-9208-0
 Europe, Middle East Branch Office | Badger Meter Europe | PO Box 341442 | Dubai Silicon Oasis, Head Quarter Building, Wing C, Office #C209 | Dubai / UAE | +971-4-371 2503
 Czech Republic | Badger Meter Czech Republic s.r.o. | Maříkova 2082/26 | 621 00 Brno, Czech Republic | +420-5-41420411
 Slovakia | Badger Meter Slovakia s.r.o. | Raciánska 109/B | 831 02 Bratislava, Slovakia | +421-2-44 63 83 01
 Asia Pacific | Badger Meter | 80 Marine Parade Rd | 21-04 Parkway Parade | Singapore 449269 | +65-63464836
 China | Badger Meter | 7-1202 | 99 Hangzhong Road | Minhang District | Shanghai | China 201101 | +86-21-5763 5412

Legacy Document Number: ICM-170-03-EN 53400-170