

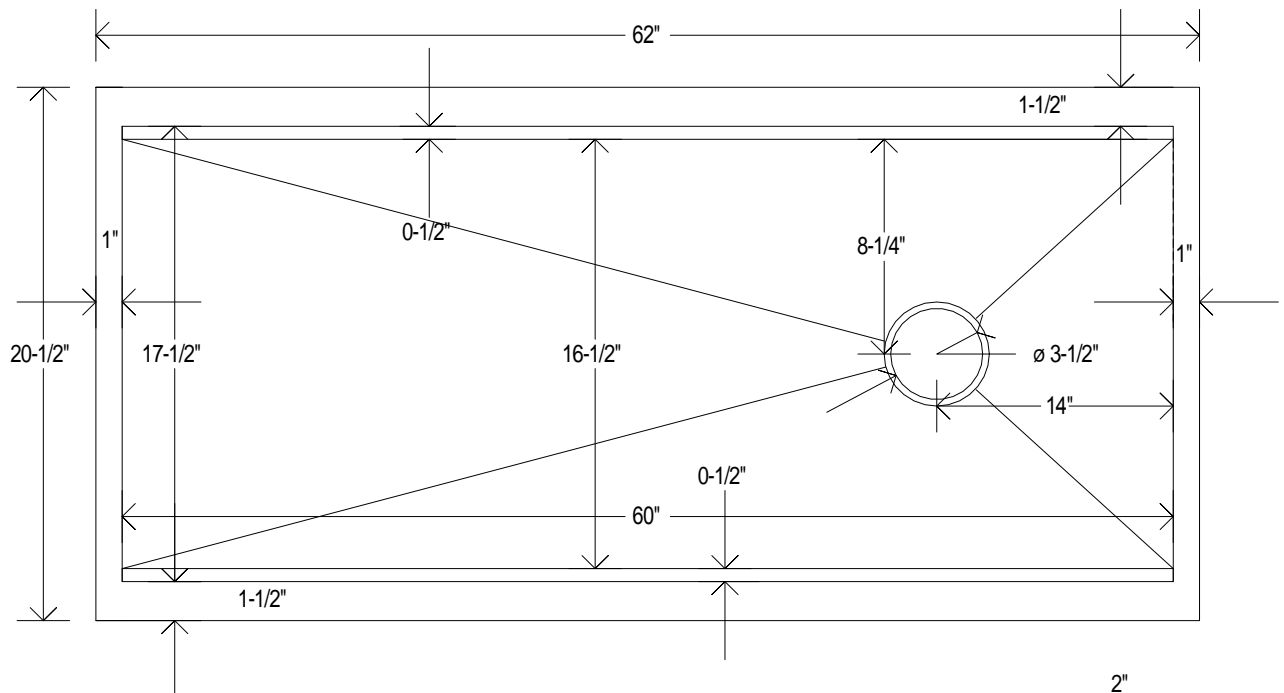

- Sink Model: 62" Eclipse Stainless Undermount
- Metal: 16-Gauge Type 316 Stainless Steel
- Non-recycled American Stainless Steel
- Overall dimensions: 62" x 20.5" x 9"
- Inside dimensions: 60" x 17.5" x 9"
- Drain Placement: Right Center - 3.5" Standard
- Installation: Undermount - 1" Perimeter Flange
- 1/2" Flange Reveal for Top Ledge

62 INCH

TOP
VIEW



FRONT
VIEW

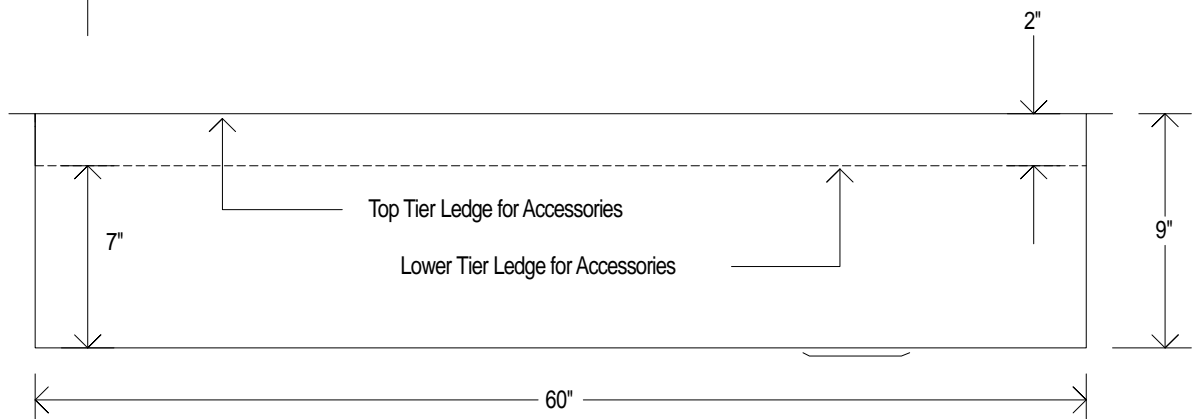

*Drawing is to scale

HAVENS



LIFETIME WARRANTY | EASY CARE | ERGONOMIC DESIGN | AMERICAN HANFCRAFTED

HANDCRAFTED IN THE USA BY HAVENS

BUILT-IN CULINARY WORKSTATION LEDGE FOR ACCESSORIES

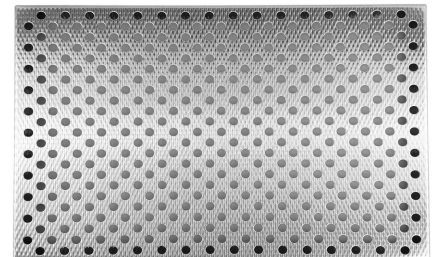
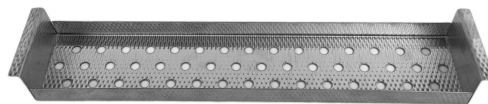

AVAILABLE CULINARY ACCESSORIES FOR THE LEGACY SINK:

12"/15" STAINLESS DRYING RACK | SPONGE & SOAP CADDY
PROFESSIONAL CUTTING BOARD | MIXING BOWL CUTTING BOARD 5
QT. PASTA STRAINER BOARD | 5 QT. MIXING BOWL BOARD TRIPLE
CONTAINER SERVE BOARD | SIX CONTAINER SERVE BOARD FILLABLE
STAINLESS DROP IN BOWL | STAINLESS DROP-IN STRAINER
2 CONTAINER & BOWL BOARD | OVEN PAN | FULL SINK COVER