

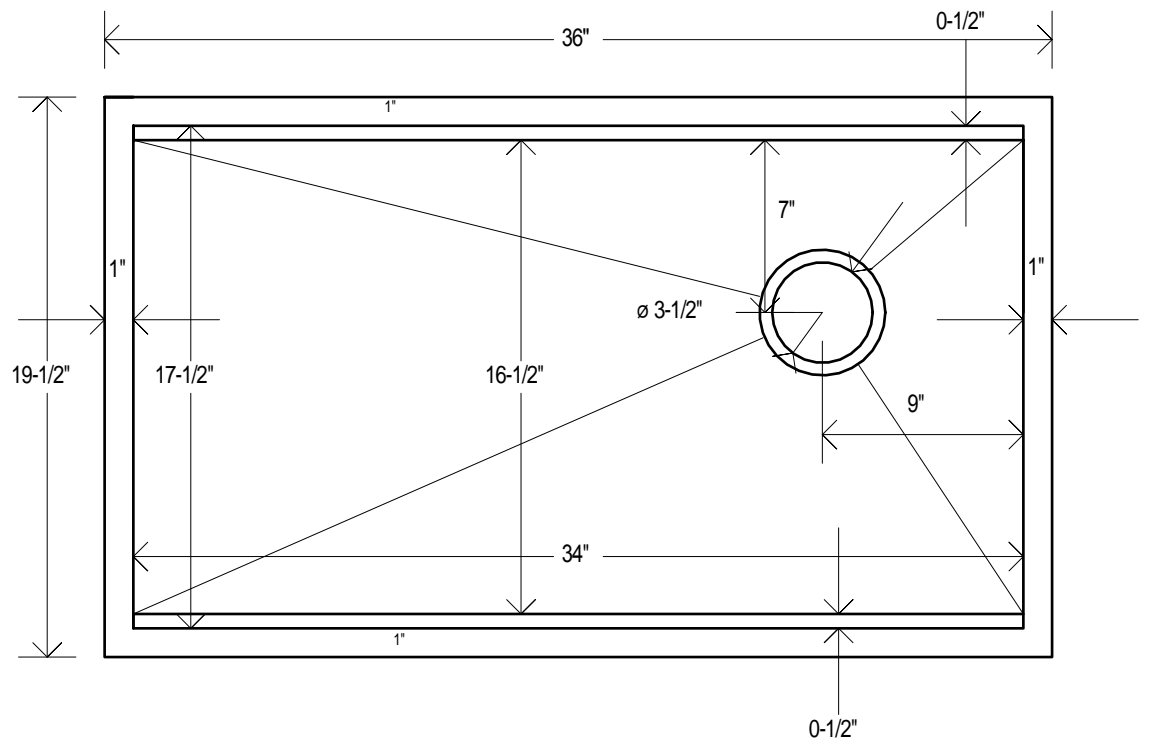

- Sink Model: 36" Legacy Stainless Undermount
- Metal: 16-Gauge Type 316 Stainless Steel
- Non-recycled American Stainless Steel
- Overall dimensions: 36" x 19.5" x 8"
- Inside dimensions: 34" x 17.5" x 8"
- Drain Placement: Right rear - 3.5" Standard
- Installation: Undermount - 1" Perimeter Flange

36
INCH

**TOP
VIEW**



**FRONT
VIEW**

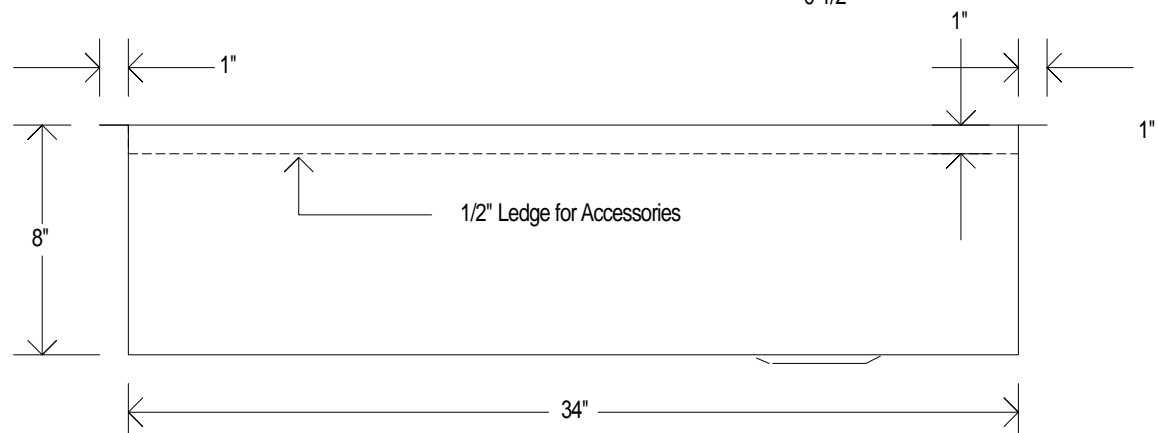

*Drawing is to scale



LIFETIME WARRANTY | EASY CARE | ERGONOMIC DESIGN | AMERICAN HANDCRAFTED
HANDCRAFTED IN THE USA BY HAVENS
BUILT-IN CULINARY WORKSTATION LEDGE FOR ACCESSORIES

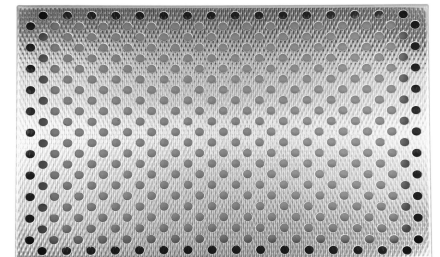
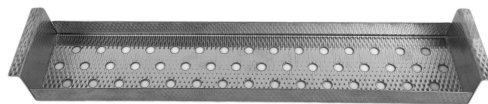

AVAILABLE CULINARY ACCESSORIES FOR THE LEGACY SINK:

- STAINLESS DRYING RACK | SPONGE & SOAP CADDY
- PROFESSIONAL CUTTING BOARD | MIXING BOWL CUTTING BOARD
- 5 QT. PASTA STRAINER BOARD | 5 QT. MIXING BOWL BOARD
- TRIPLE CONTAINER SERVE BOARD | SIX CONTAINER SERVE BOARD
- STAINLESS DROP IN BOWL | STAINLESS DROP-IN STRAINER
- 2 CONTAINER & BOWL BOARD | OVEN PAN | FULL SINK COVER



REVOLUTIONARY



HIGHLY VERSATILE



LAVISH DESIGNS

SELECT ADVANCED SINK ACCESSORIES FOR YOUR SINK

LIFETIME WARRANTY | EASY CARE | ERGONOMIC DESIGN | AMERICAN HANDCRAFTED

SELECT ACCESSORIES TO ADD TO YOUR EXISTING SINK ORDER

PRO CUTTING BOARD

12-INCH - \$80 -

15-INCH - \$100 -

18-INCH - \$120 -

MIXING BOWL BOARD

12-INCH - \$80 -

15-INCH - \$100 -

18-INCH - \$120 -

SELECT FINISH

AMBER BAMBOO -

LIGHT BAMBOO -

POLY WHITE -

POLY BLACK -

TRIPLE SERVE BOARD

12-INCH - \$80 -

15-INCH - \$100 -

18-INCH - \$120 -

BOWL & DOUBLE CONTAINER BOARD

12-INCH - \$80 -

15-INCH - \$100 -

18-INCH - \$120 -

STAINLESS DRYING RACK

12-INCH - \$250 -

15-INCH - \$280 -

18-INCH - \$320 -

STAINLESS DROP IN STRAINER

12-INCH - \$350 -

15-INCH - \$400 -

18-INCH - \$450 -

STAINLESS DROP IN BOWL

12-INCH - \$450 -

15-INCH - \$500 -

18-INCH - \$550 -

STAINLESS SPONGE CADDY - \$160 -

SEGMENTED SINK COVER - \$250 -

STAINLESS BASIN GRATE - \$500 -