

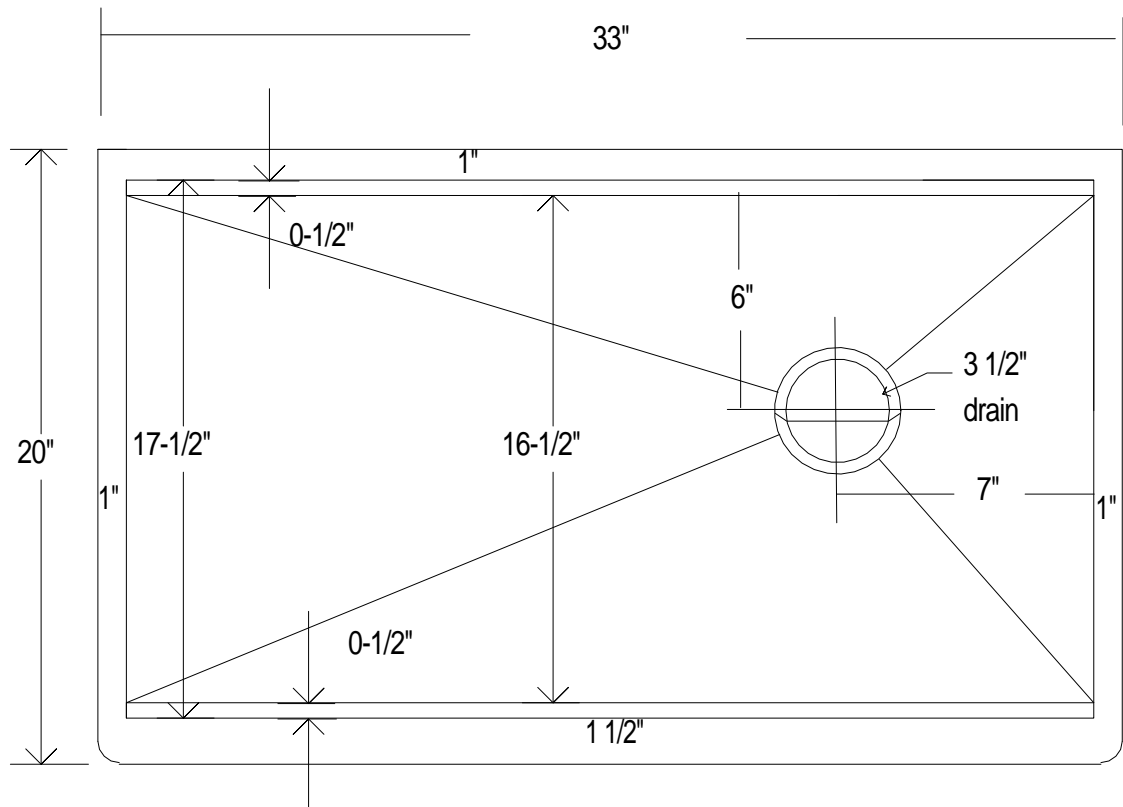

- **Sink Model:** 33" Nova Copper Farmhouse
- **Metal:** 14-Gauge 48oz American Copper
- **Non-recycled** - 99.9% Purity Rating
- **Overall dimensions:** 33" x 20" x 8"
- **Inside dimensions:** 31" x 17.5" x 8"
- **Drain Placement:** Right rear - 3.5" Standard
- **Installation:** Undermount - 1" Perimeter Flange

33
INCH

TOP
VIEW



FRONT
VIEW

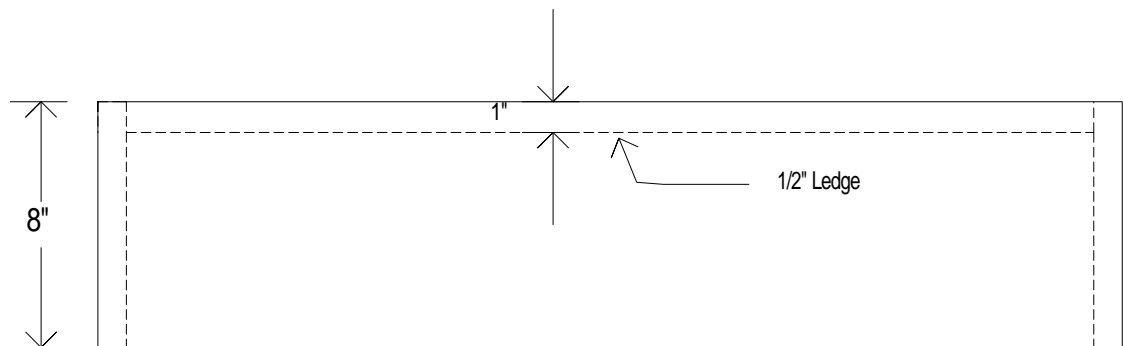

*Drawing is to scale



LIFETIME WARRANTY | EASY CARE | ERGONOMIC DESIGN | ANTIMICROBIAL SURFACE

HANDCRAFTED IN THE USA BY HAVENS

BUILT-IN CULINARY WORKSTATION LEDGE FOR ACCESSORIES

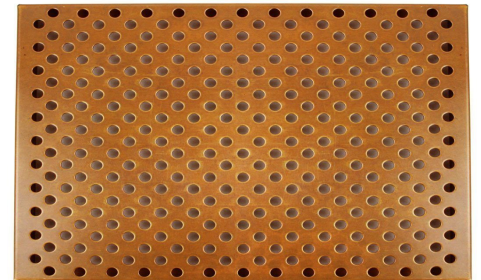

AVAILABLE CULINARY ACCESSORIES FOR THE LEGACY SINK:

COPPER DRYING RACK | SPONGE & SOAP CADDY

PROFESSIONAL CUTTING BOARD | MIXING BOWL CUTTING BOARD

5 QT. PASTA STRAINER BOARD | 5 QT. MIXING BOWL BOARD

TRIPLE CONTAINER SERVE BOARD | SIX CONTAINER SERVE BOARD

FILLABLE COPPER DROP IN BOWL | COPPER DROP-IN STRAINER

BOWL & 2 X CONTAINER BOARD | OVEN PAN | FULL SINK COVER



REVOLUTIONARY



HIGHLY VERSATILE



LAVISH DESIGNS

SELECT ADVANCED SINK ACCESSORIES FOR YOUR SINK

LIFETIME WARRANTY | EASY CARE | ERGONOMIC DESIGN | AMERICAN HANDCRAFTED

SELECT ACCESSORIES TO ADD TO YOUR EXISTING SINK ORDER

PRO CUTTING BOARD

12-INCH - \$80 -

15-INCH - \$100 -

18-INCH - \$120 -

MIXING BOWL BOARD

12-INCH - \$80 -

15-INCH - \$100 -

18-INCH - \$120 -

SELECT FINISH

AMBER BAMBOO -

LIGHT BAMBOO -

POLY WHITE -

POLY BLACK -

TRIPLE SERVE BOARD

12-INCH - \$80 -

15-INCH - \$100 -

18-INCH - \$120 -

BOWL & DOUBLE CONTAINER BOARD

12-INCH - \$80 -

15-INCH - \$100 -

18-INCH - \$120 -

STAINLESS DRYING RACK

12-INCH - \$250 -

15-INCH - \$280 -

18-INCH - \$320 -

STAINLESS DROP IN STRAINER

12-INCH - \$350 -

15-INCH - \$400 -

18-INCH - \$450 -

STAINLESS DROP IN BOWL

12-INCH - \$450 -

15-INCH - \$500 -

18-INCH - \$550 -

STAINLESS SPONGE CADDY - \$160 -

SEGMENTED SINK COVER - \$250 -

STAINLESS BASIN GRATE - \$500 -