

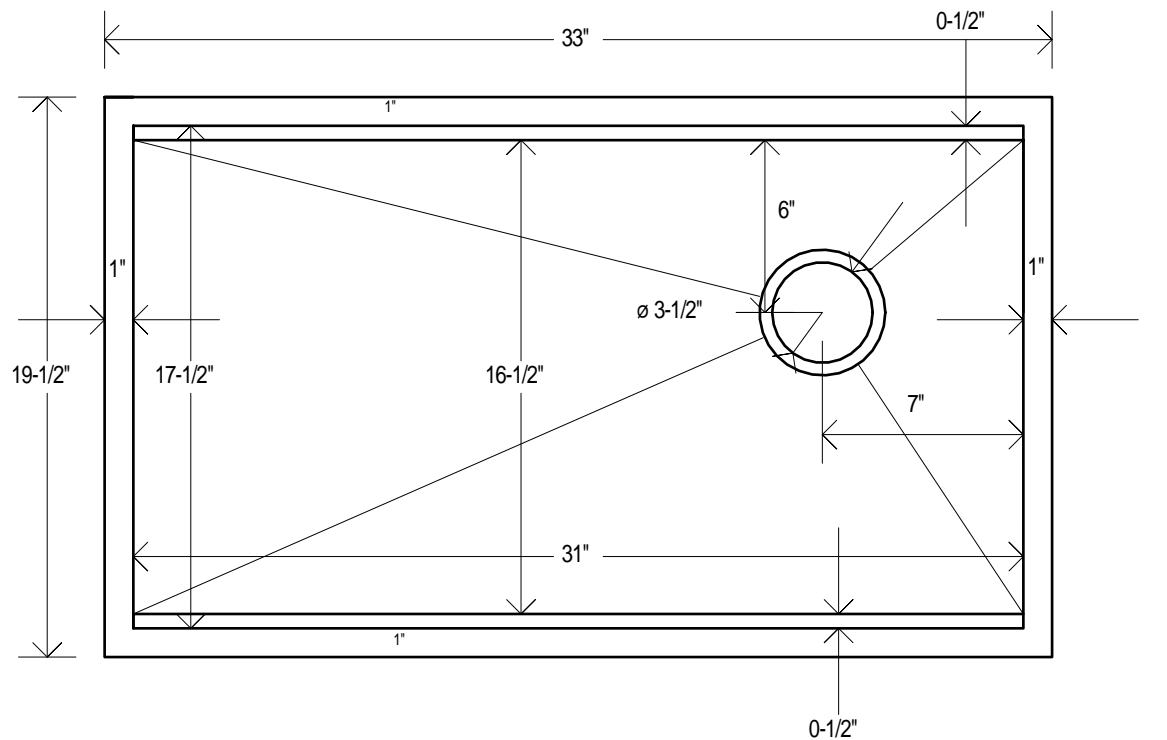

- Sink Model: 33" Legacy Copper Undermount
- Metal: 14-Gauge 48oz American Copper
- Non-recycled - 99.9% Purity Rating
- Overall dimensions: 33" x 19.5" x 8"
- Inside dimensions: 31" x 17.5" x 8"
- Drain Placement: Right rear - 3.5" Standard
- Installation: Undermount - 1" Perimeter Flange

33  
INCH

TOP  
VIEW



FRONT  
VIEW

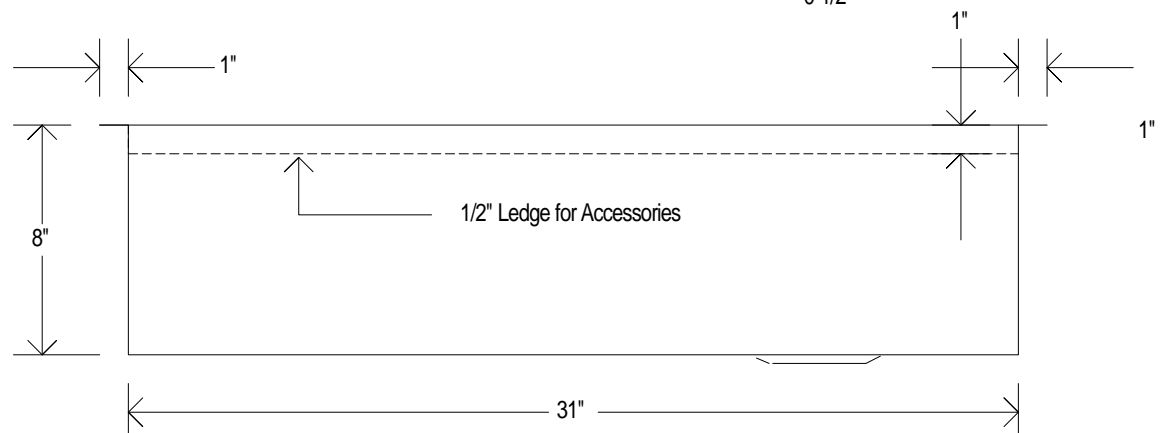

\*Drawing is to scale



LIFETIME WARRANTY | EASY CARE | ERGONOMIC DESIGN | ANTIMICROBIAL SURFACE

**HANDCRAFTED IN THE USA BY HAVENS**

**BUILT-IN CULINARY WORKSTATION LEDGE FOR ACCESSORIES**

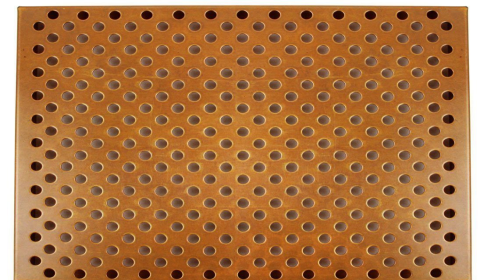

### AVAILABLE CULINARY ACCESSORIES FOR THE LEGACY SINK:

12"/15" COPPER DRYING RACK | SPONGE & SOAP CADDY  
PROFESSIONAL CUTTING BOARD | MIXING BOWL CUTTING BOARD  
5 QT. PASTA STRAINER BOARD | 5 QT. MIXING BOWL BOARD  
TRIPLE CONTAINER SERVE BOARD | SIX CONTAINER SERVE BOARD  
FILLABLE COPPER DROP IN BOWL | COPPER DROP-IN STRAINER  
BOWL & 2 X CONTAINER BOARD | OVEN PAN | FULL SINK COVER



**REVOLUTIONARY**



**HIGHLY VERSATILE**



**LAVISH DESIGNS**

### SELECT ADVANCED SINK ACCESSORIES FOR YOUR SINK

LIFETIME WARRANTY | EASY CARE | ERGONOMIC DESIGN | AMERICAN HANDCRAFTED

#### SELECT ACCESSORIES TO ADD TO YOUR EXISTING SINK ORDER

##### PRO CUTTING BOARD

12-INCH - \$80 -

15-INCH - \$100 -

18-INCH - \$120 -

##### MIXING BOWL BOARD

12-INCH - \$80 -

15-INCH - \$100 -

18-INCH - \$120 -

##### SELECT FINISH

AMBER BAMBOO -

LIGHT BAMBOO -

POLY WHITE -

POLY BLACK -

##### TRIPLE SERVE BOARD

12-INCH - \$80 -

15-INCH - \$100 -

18-INCH - \$120 -

##### BOWL & DOUBLE CONTAINER BOARD

12-INCH - \$80 -

15-INCH - \$100 -

18-INCH - \$120 -

##### STAINLESS DRYING RACK

12-INCH - \$250 -

15-INCH - \$280 -

18-INCH - \$320 -

##### STAINLESS DROP IN STRAINER

12-INCH - \$350 -

15-INCH - \$400 -

18-INCH - \$450 -

##### STAINLESS DROP IN BOWL

12-INCH - \$450 -

15-INCH - \$500 -

18-INCH - \$550 -

STAINLESS SPONGE CADDY - \$160 -

SEGMENTED SINK COVER - \$250 -

STAINLESS BASIN GRATE - \$500 -