

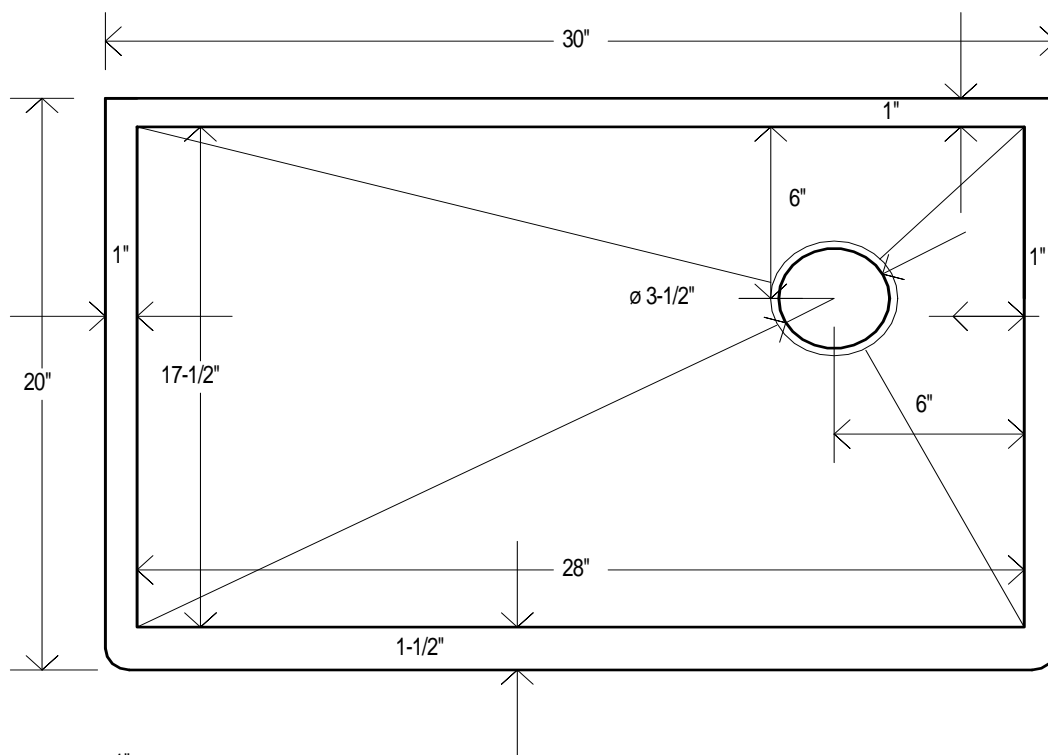

- Sink Model: 30" Heritage Stainless Farmhouse
- Metal: 16-Gauge Type 316 Stainless Steel
- Non-recycled American Stainless Steel
- Overall dimensions: 30" x 20" x 8"
- Inside dimensions: 28" x 17.5" x 8"
- Drain Placement: Right rear - 3.5" Standard
- Installation: Undermount - 1" Perimeter Flange

30
INCH

TOP
VIEW



FRONT
VIEW

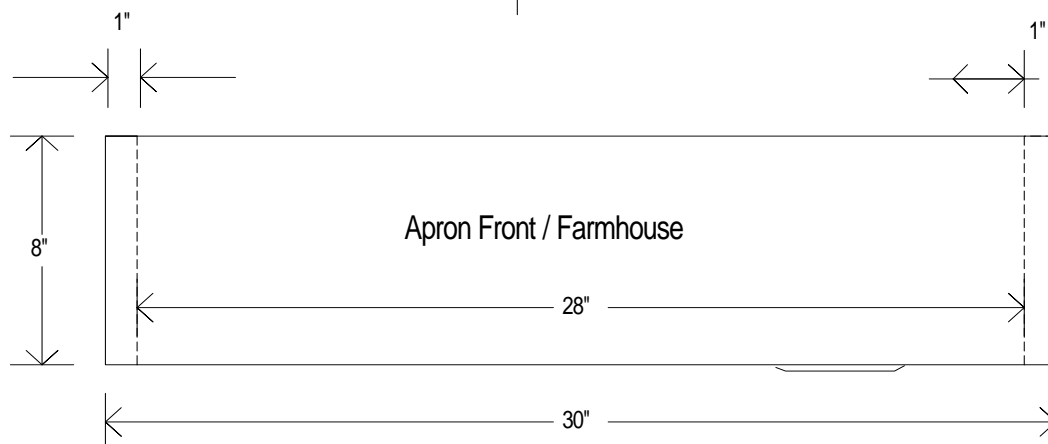

*Drawing is to scale



LIFETIME WARRANTY | EASY CARE | ERGONOMIC DESIGN | AMERICAN HANDCRAFTED
H A N D C R A F T E D I N T H E U S A B Y H A V E N S

How To Clean & Maintain a Havens Stainless Sink

1. **Apply soap** or any household detergent to a wet sponge or any dish washing applicator. Scrub the inside of the sinks basin with the soapy sponge, applying a light pressure to wipe through any foods particles and debris.
2. **Rinse away** the soap and residuals with running water from the faucet. Allow the sink to drain itself, and air dry completely - this only takes a few minutes.
3. **If preferred** (not required) apply your included stainless steel conditioner to recondition the luster of the metal, giving it a sheen and somewhat reflective appearance. A bottle of conditioner is included with every Havens sink - a little bit goes a long way.

Havens products are exclusively handcrafted from the highest quality materials available, which is why care and cleaning is significantly less involved than other sinks. Over 95% of sinks available are made outside of the USA, and imported to save on labor and material costs. This is untrue for Havens sinks, as we never compromise quality for quantity. Whether you plan on selecting a copper or stainless steel sink, it's important to consider the quality, warranty, and overall durability of the metal.