



R

Issue : 0001

Thank you for purchasing your Lean-To from Ruby. Simply follow these step by step instructions and our top tips and you'll be enjoying your Lean-To for many years to come. If you have any questions or need advice, our friendly team is here to help.

Corrapol® PVC Lean-To

Assembly Instructions

For all sizes of Ruby Lean-Tos

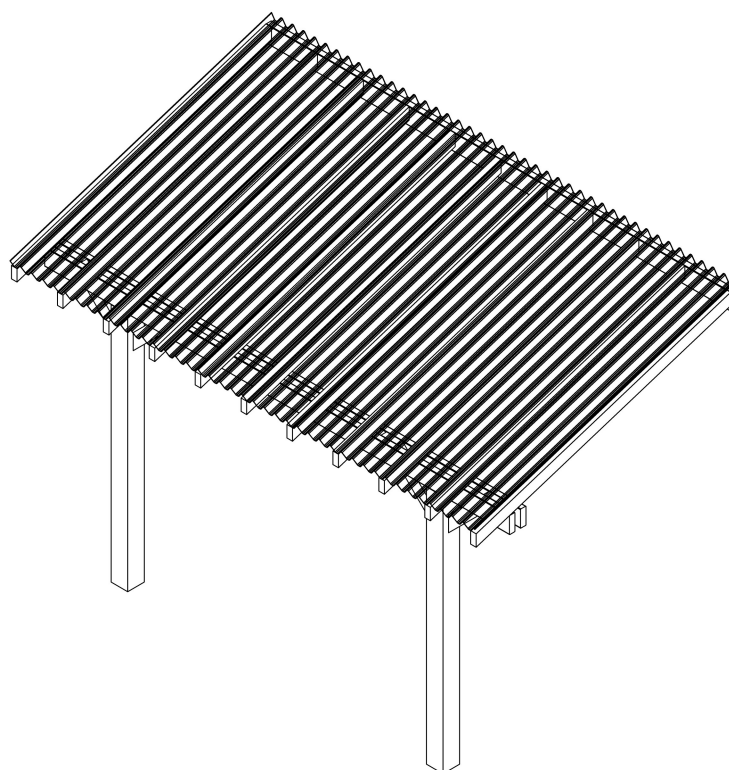
**Missing Something?**

Call our aftersales team on
01409 231 763—Option 1

Need More Information?









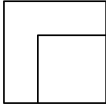

Call our technical team on
01409 231 763—Option 2

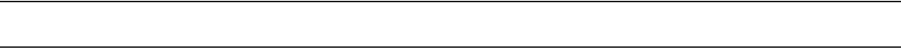
**Visit our website for more
information**

www.ruby-group.co.uk

Timber Parts List:

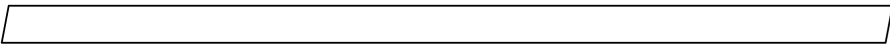
Quantities and lengths of timber parts will vary dependent on the size of your Lean-To. The assembly instructions however are identical for all Lean-To sizes.

Uprights 2320x150x150		
Front Beam 150x50 Profile		
Wall Brace 150x50 Profile		
45° Bracing 150x50 Profile		
Roof Spars 100x50 Profile		
Length Edge Trim 150x25 Profile		
Corrapol Roofing Corrapol Install Pack		

Fixing Parts List:

Quantities of fixings will vary dependent on the size of your Lean-To. The assembly instructions however are identical for all Lean-To sizes.

6mm Wood Screw 150mm nom length	
5mm Wood Screw 100mm nom length	

Missing Something?

Call our aftersales team on
01409 231 763—Option 1

Need More Information?

Call our technical team on
01409 231 763—Option 2

Visit our website for more information

www.ruby-group.co.uk

Before You Start

Please read through these instructions to familiarise yourself with your product. We recommend that you check all the components using the lists found on the front page before you start to build.

All of our Lean-Tos are constructed in the same way. They simply come with different components depending on the type of Lean-To you have. Don't worry if your fixing pack contains some spare items at the end of the build (you haven't missed a bit!) we have sent you a generic fixing pack to suit the Lean-To range.

Preparation

It's vital that you build your new Lean-To on a **solid, level base**.

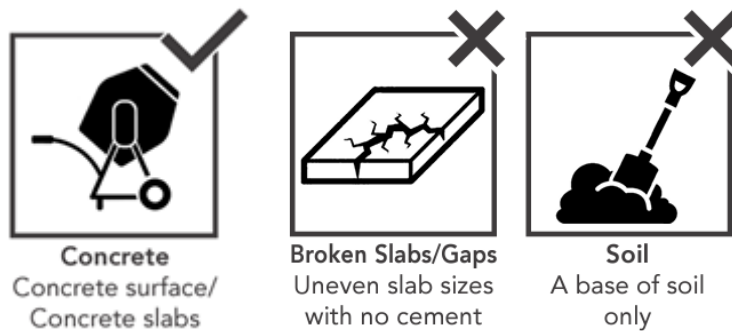

If you have an existing base and think it's suitable for your new Lean-To to be sited on, it is important you check that it is level and doesn't deviate by any more than 15mm from edge to edge. If this isn't the case the building will twist, causing gaps to appear in the roof sections.

Tools Needed

We recommend using the following tools (not supplied):



Tape Measure



Sharp Knife



Pozidrive Screwdriver



Drill & 2mm Drill Bit



Hammer



Ladder

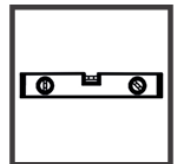

Spirit Level

Missing Something?

Call our aftersales team on
01409 231 763—Option 1

Need More Information?

Call our technical team on
01409 231 763—Option 2

Visit our website for more information

www.ruby-group.co.uk

Care & Attention

Things To Notice

MOVEMENT, TWISTING & WARPING

Wood contains a natural level of moisture so decreasing humidity levels in the surrounding air may cause panels to change their shape as the porous fibres shrink. This can be exaggerated during prolonged periods of dry weather. Movement and gaps in timber products are normal, in most cases the wood will revert to its original form once the high temperatures subside and there is more moisture content in the air. Similarly, in the winter months, the opposite may occur with wood swelling.

EXPANSION, CONTRACTION, SPLITS & CRACKS

All timber will expand and contract according to its environment. As a result of this expansion and contraction, it is very common to see splits and cracks developing in the wood. Splits are common during the spring and summer months as the wood begins to dry out. The outer surface dries first and contracts, contracting over a still expanded core of the wood. The result of this is that splits and cracks appear along the grain of wood. These splits are not a fault and do not affect the structural integrity of a product.

MOULD & BLUE STAIN

Mould is a surface-dwelling fungus that feeds on the nutrients and debris contained in the surface cells of timber. The most common problems associated with mould are discoloured timber and an increase in permeability of the timber. Blue stain is part of the same family but penetrates deeper into the surface layers of the timber. It stains the timber a dark blue, whereas mould is usually black. These do not cause the timber to rot. Keep the building well ventilated to avoid mould.

THE ROOF OF THIS BUILDING IS NOT A LOAD BEARING STRUCTURE

Construction

Assembly is relatively straightforward if you follow these step by step instructions.

We recommend getting everything aligned properly before screwing together and that screw holes should be pre-drilled to avoid splitting the timber.



IMPORTANT

Assembly requires 2+ adults.



REMINDER

Always pre-drill before screwing.

Missing Something?

Call our aftersales team on
01409 231 763—Option 1

Need More Information?

Call our technical team on
01409 231 763—Option 2

Visit our website for more information

www.ruby-group.co.uk

Construction

1 Right and Left Side

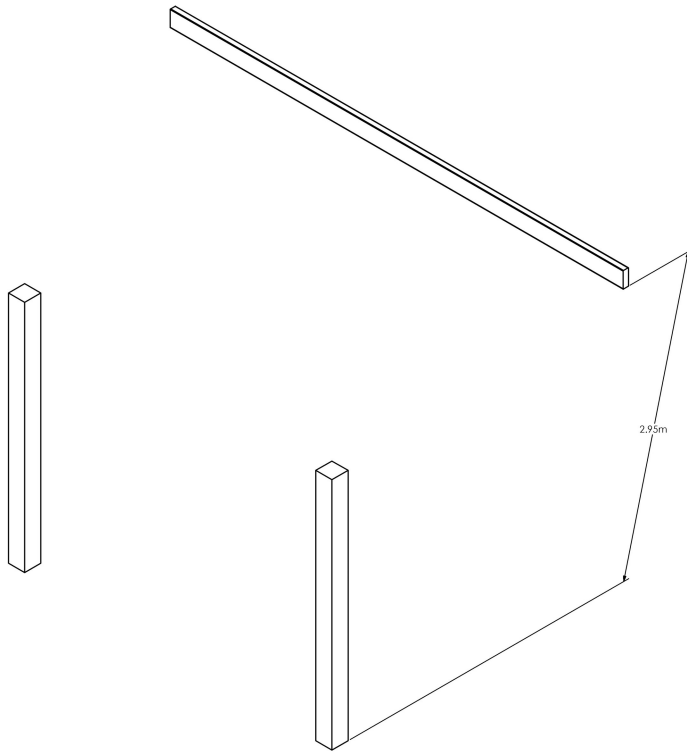

Install your selected post bases onto the 2320mm 150x150 uprights. Then, using the correct fixings for your type of wall finish, secure the wall brace onto your wall, ensuring the bottom of the brace is 2.95m above ground level.

2 Front Beams & Bracing

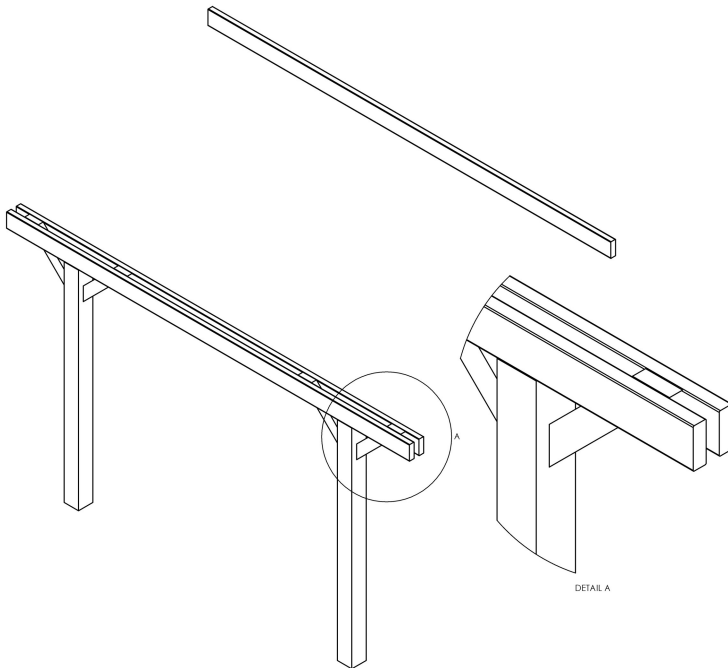

Secure the first front beam member to the rear of the uprights using the supplied 6mm x 150mm wood screws, creating one freestanding structure.

Then fix the 45 degree bracing members to the front ring beam and the uprights using the supplied 5mm x 100mm wood screws.

Finally fit the second front beam member to the 45 degree bracings and the uprights using the supplied 5mm x 100mm wood screws.

Missing Something?

Call our aftersales team on
01409 231 763—Option 1

Need More Information?

Call our technical team on
01409 231 763—Option 2

Visit our website for more information

www.ruby-group.co.uk

Construction

3 Mid Lean-To Structure and Bracing

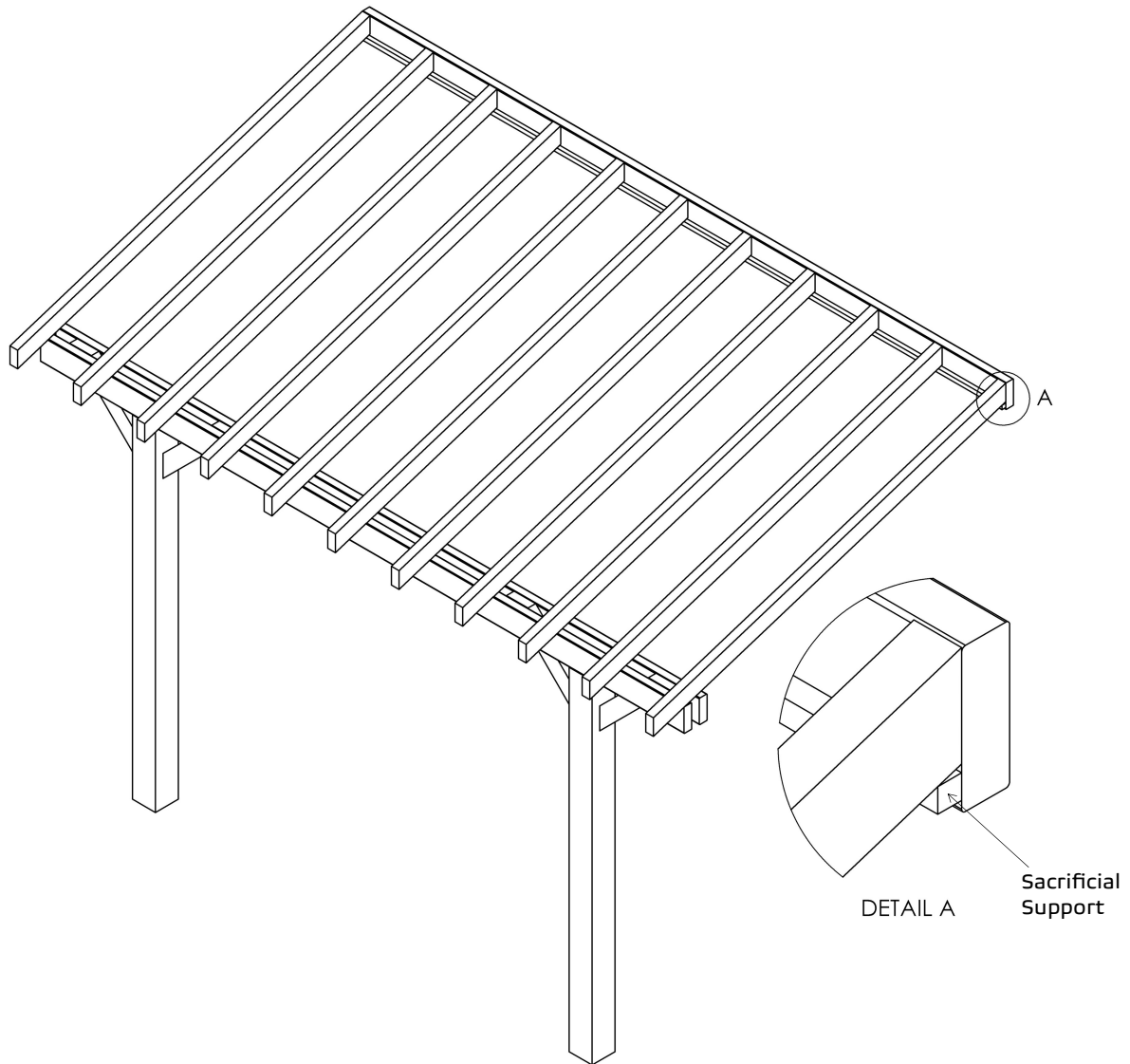

One at a time, install the roof spars to the two front beam members and wall brace, using the supplied 6mm x 150mm wood screws.

For ease of installation, it is suggested that a sacrificial piece of timber is screwed to the bottom of the wall brace, enabling you to rest the roof spars on the base structure and sacrificial piece.

Missing Something?

Call our aftersales team on
01409 231 763—Option 1

Need More Information?

Call our technical team on
01409 231 763—Option 2

Visit our website for more information

www.ruby-group.co.uk