



R

Issue : 0001

Thank you for purchasing your Pergola from Ruby. Simply follow these step by step instructions and our top tips and you'll be enjoying your Pergola for many years to come. If you have any questions or need advice, our friendly team is here to help.

Open Roof 4 Sided Apex Pergola Assembly Instructions

For all sizes of Ruby Pergolas

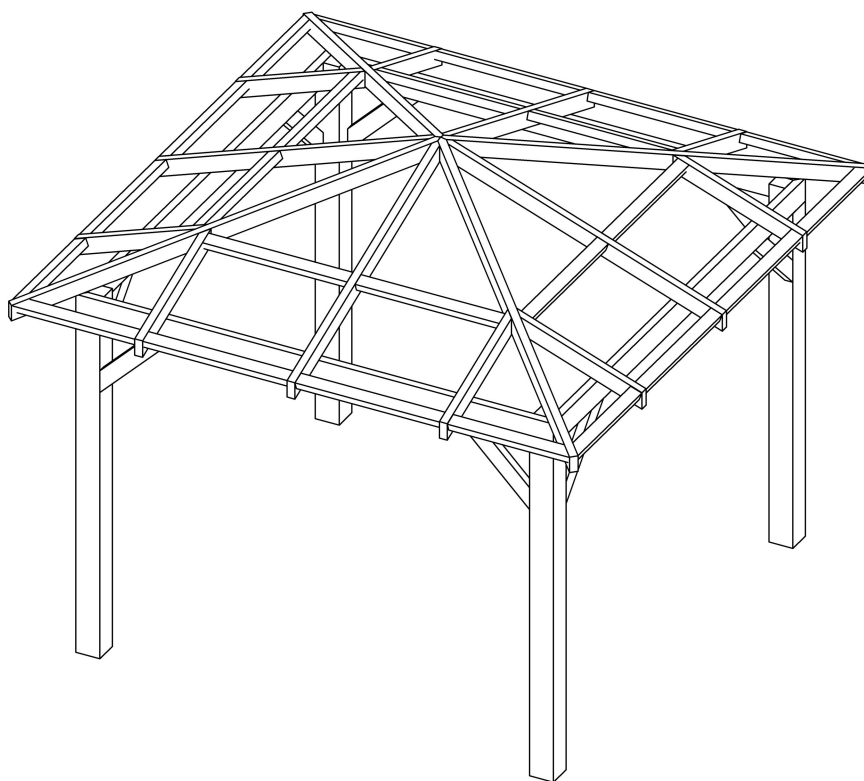
**Missing Something?**

Call our aftersales team on
01409 231 763—Option 1

Need More Information?











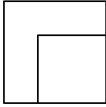

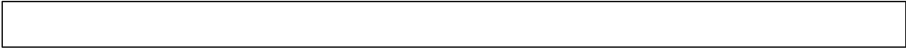

Call our technical team on
01409 231 763—Option 2

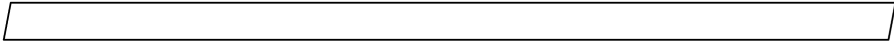
**Visit our website for more
information**

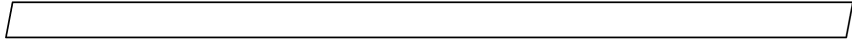
www.ruby-group.co.uk

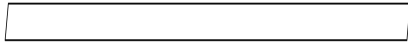
Timber Parts List:

Quantities and lengths of timber parts will vary dependent on the size of your pergola. The assembly instructions however are identical for all pergola sizes.

Uprights 2320x150x150		
Length Ring Beam 150x50 Profile		
Front/Rear Ring Beam 150x50 Profile		
Main Roof Rafter 100x50 Profile		
Half Roof Bracing 100x50 Profile		
Quarter Roof Bracing		
Horizontal Bracing 150x50 Profile		
45° Bracing 150x50 Profile		

Fixing Parts List:

Quantities of fixings will vary dependent on the size of your pergola. The assembly instructions however are identical for all pergola sizes.

6mm Wood Screw 150mm nom length	
5mm Wood Screw 100mm nom length	

Missing Something?

Call our aftersales team on
01409 231 763—Option 1

Need More Information?

Call our technical team on
01409 231 763—Option 2

Visit our website for more information

www.ruby-group.co.uk

Before You Start

Please read through these instructions to familiarise yourself with your product. We recommend that you check all the components using the lists found on the front page before you start to build.

All of our Pergolas are constructed in the same way. They simply come with different components depending on the type of Pergola you have. Don't worry if your fixing pack contains some spare items at the end of the build (you haven't missed a bit!) we have sent you a generic fixing pack to suit the Pergola range.

Preparation

It's vital that you build your new Pergola on a **solid, level base**.

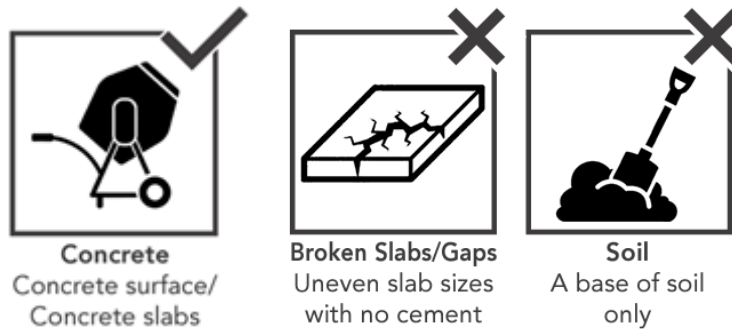

If you have an existing base and think it's suitable for your new pergola to be sited on, it is important you check that it is level and doesn't deviate by any more than 15mm from edge to edge. If this isn't the case the building will twist, causing gaps to appear in the roof sections.

Tools Needed

We recommend using the following tools (not supplied):



Tape Measure



Sharp Knife



Pozidrive Screwdriver



Drill & 2mm Drill Bit



Hammer



Ladder

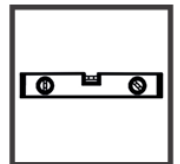

Spirit Level

Missing Something?

Call our aftersales team on
01409 231 763—Option 1

Need More Information?

Call our technical team on
01409 231 763—Option 2

Visit our website for more information

www.ruby-group.co.uk

Care & Attention

Things To Notice

MOVEMENT, TWISTING & WARPING

Wood contains a natural level of moisture so decreasing humidity levels in the surrounding air may cause panels to change their shape as the porous fibres shrink. This can be exaggerated during prolonged periods of dry weather. Movement and gaps in timber products are normal, in most cases the wood will revert to its original form once the high temperatures subside and there is more moisture content in the air. Similarly, in the winter months, the opposite may occur with wood swelling.

EXPANSION, CONTRACTION, SPLITS & CRACKS

All timber will expand and contract according to its environment. As a result of this expansion and contraction, it is very common to see splits and cracks developing in the wood. Splits are common during the spring and summer months as the wood begins to dry out. The outer surface dries first and contracts, contracting over a still expanded core of the wood. The result of this is that splits and cracks appear along the grain of wood. These splits are not a fault and do not affect the structural integrity of a product.

MOULD & BLUE STAIN

Mould is a surface-dwelling fungus that feeds on the nutrients and debris contained in the surface cells of timber. The most common problems associated with mould are discoloured timber and an increase in permeability of the timber. Blue stain is part of the same family but penetrates deeper into the surface layers of the timber. It stains the timber a dark blue, whereas mould is usually black. These do not cause the timber to rot. Keep the building well ventilated to avoid mould.

THE ROOF OF THIS BUILDING IS NOT A LOAD BEARING STRUCTURE

Construction

Assembly is relatively straightforward if you follow these step by step instructions.

We recommend getting everything aligned properly before screwing together and that screw holes should be pre-drilled to avoid splitting the timber.



IMPORTANT

Assembly requires 2+ adults.



REMINDER

Always pre-drill before screwing.

Missing Something?

Call our aftersales team on
01409 231 763—Option 1

Need More Information?

Call our technical team on
01409 231 763—Option 2

Visit our website for more information

www.ruby-group.co.uk

Construction

1 Right and Left Side

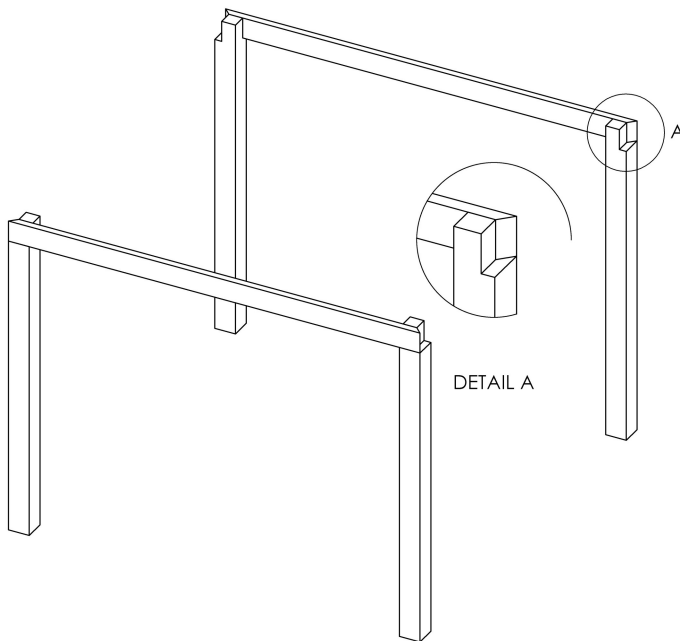

Install your selected post bases onto the notched 2320mm 150x150 uprights. Then, using the supplied 6mm x 150mm wood screws, secure the length ring beam members to the recessed side of the top

2 Front and Rear Ring Beam

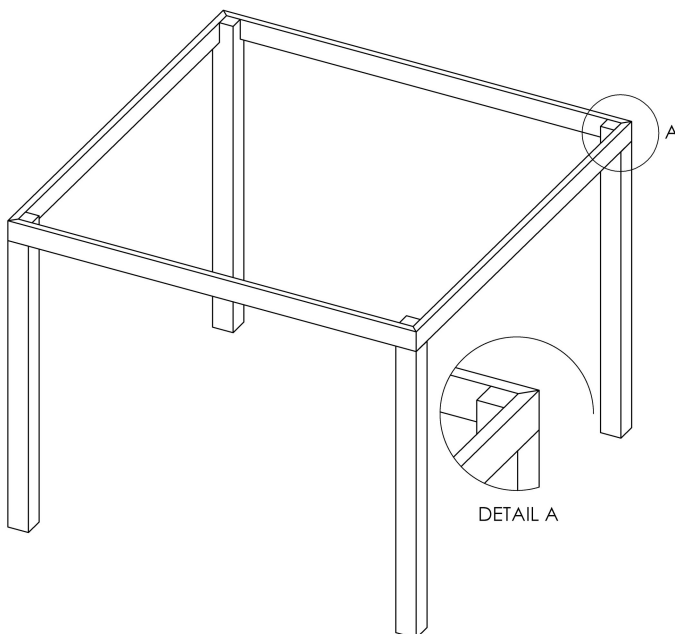

Secure the front and rear ring beam members to the existing 2 structures using the supplied 6mm x 150mm wood screws, creating one freestanding structure.

Missing Something?

Call our aftersales team on
01409 231 763—Option 1

Need More Information?

Call our technical team on
01409 231 763—Option 2

Visit our website for more information

www.ruby-group.co.uk

Construction

3.1 Pergola Roof Structure and Bracing

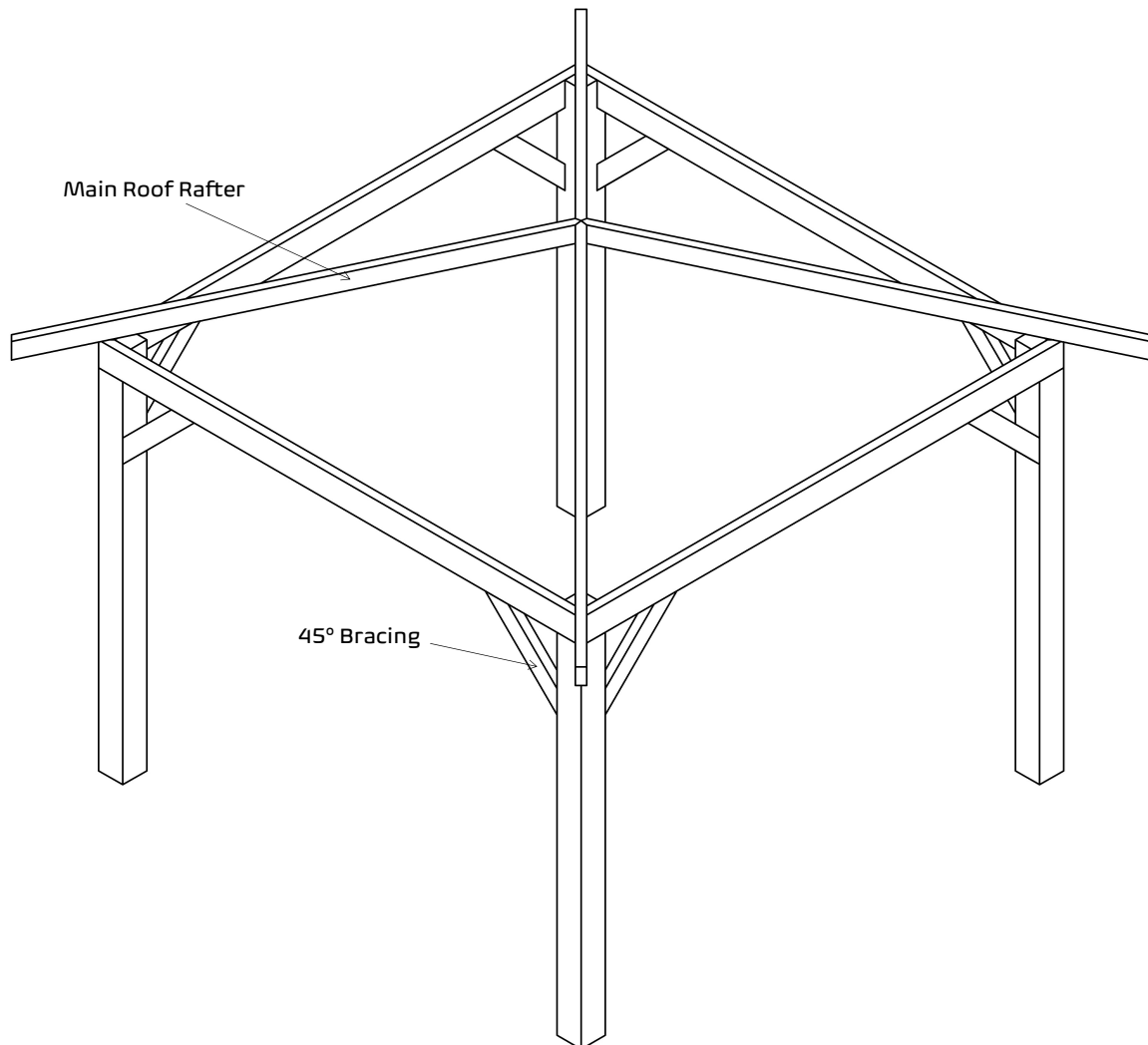

Using the 8 x 45 degree angled braces supplied, secure the 2320mm uprights to the ring beams using the supplied 5mm x 100mm wood screws.

Then, secure the 4 main roof rafters together at their 90° join creating the base of the roof structure. Then secure the base roof structure to the ring beam as seen in the image above, using the supplied 6mm x 150mm wood screws.

Missing Something?

Call our aftersales team on
01409 231 763—Option 1

Need More Information?

Call our technical team on
01409 231 763—Option 2

Visit our website for more
information

www.ruby-group.co.uk

Construction

3.2 Roof Bracing

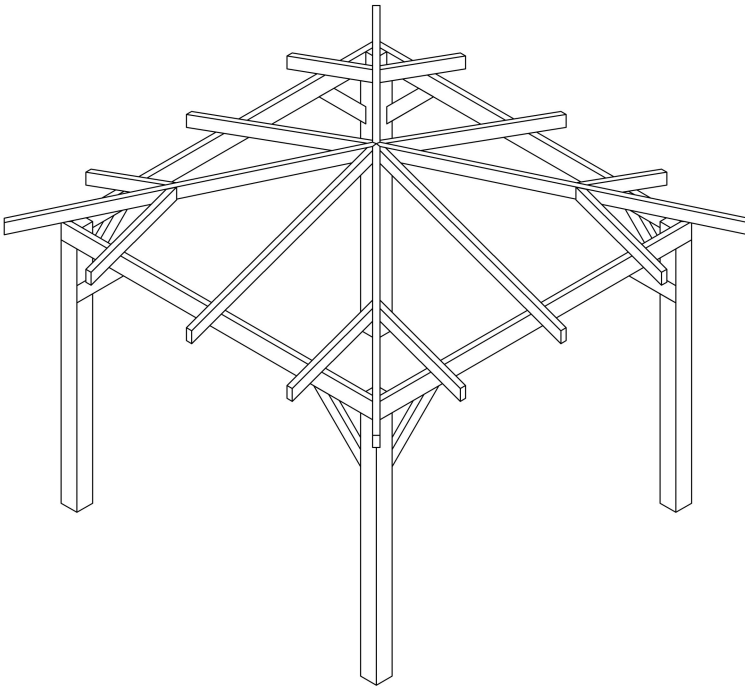

Install the half roof bracing and quarter roof bracing to the existing roof structure using the supplied 5mm x 100mm wood screws.

3.3 Roof Horizontal Bracing

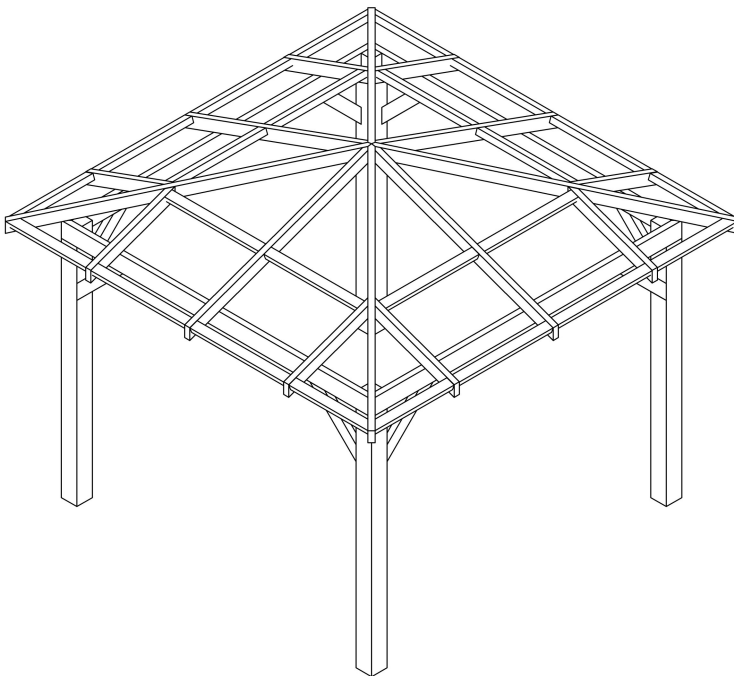

Install the horizontal roof bracing periodically through the frame of the roof using the supplied 5mm X 100mm wood screws.

Missing Something?

Call our aftersales team on
01409 231 763—Option 1

Need More Information?

Call our technical team on
01409 231 763—Option 2

Visit our website for more information

www.ruby-group.co.uk