

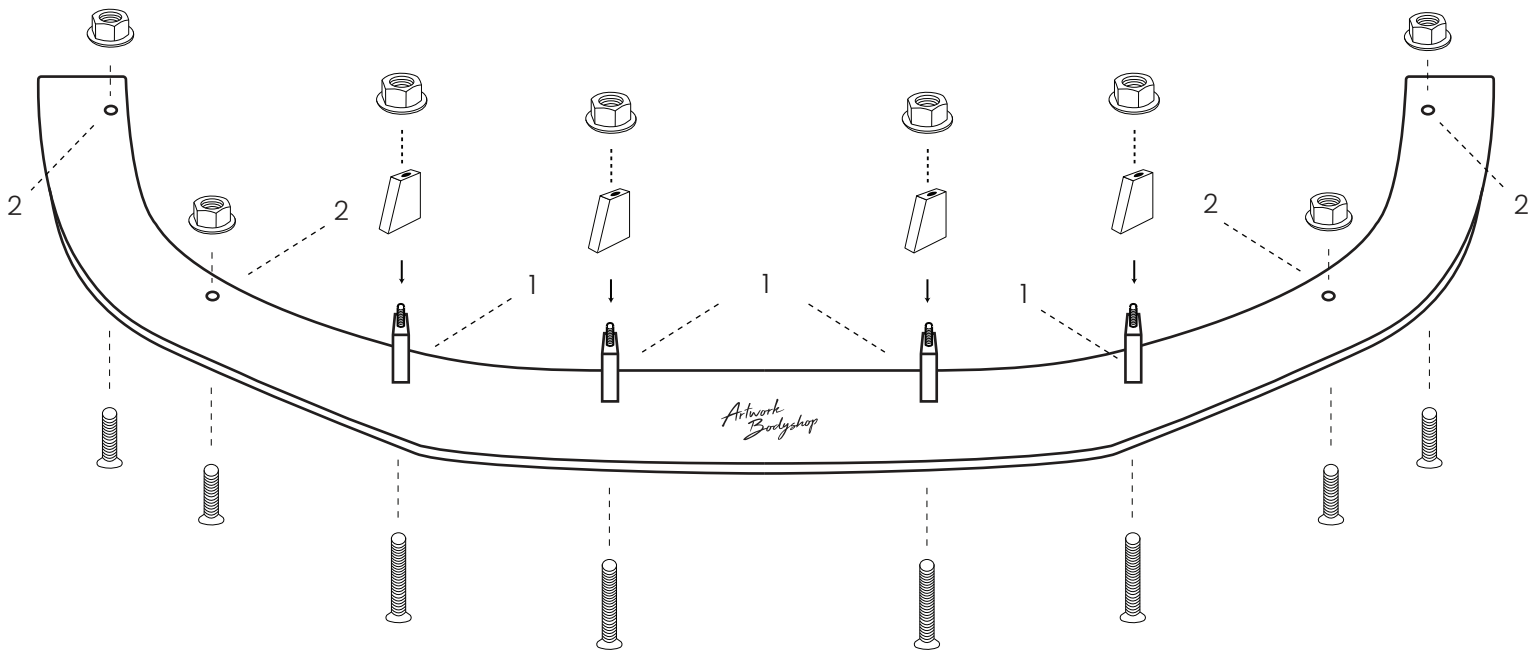



1. 55mm Bolts / Spacers
2. 25mm Bolts



PARTS LIST MAY DIFFER ACCORDING TO YOUR MODEL

PARTS LIST	
	1-1/4" Spacers x 2
	M8 Lock Nuts x 8
	25mm M8 Bolts x 4
	55mm M8 Bolts x 4

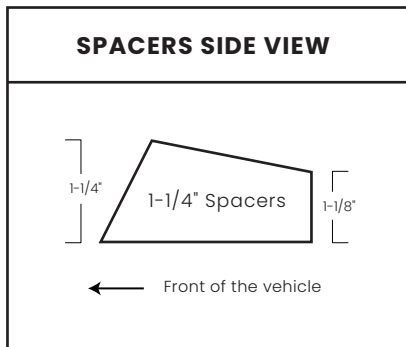

*Install your bolts with your hex key by the bottom of your lip.

	M8 Hex Key X 1
---	----------------

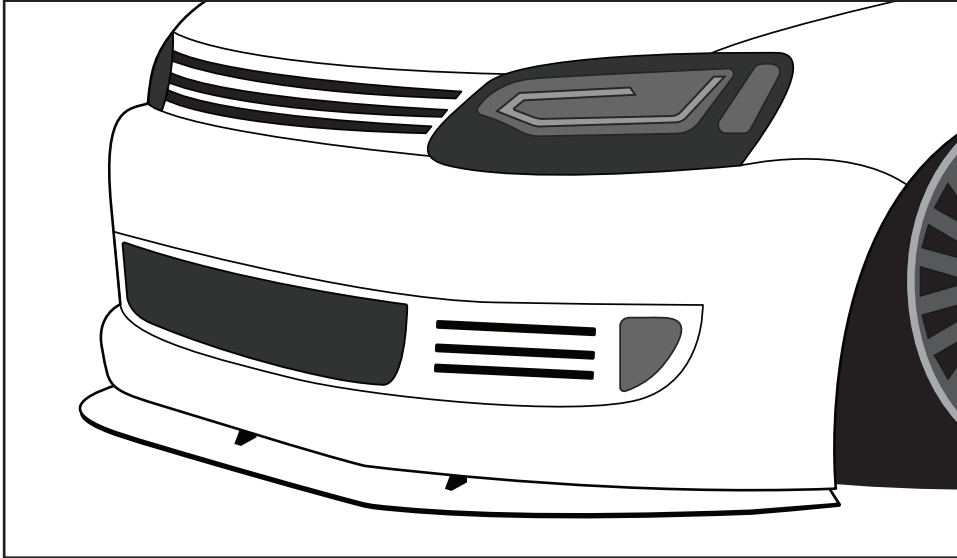

TOOLS REQUIRED

- ☑ CAR JACK & JACK STANDS
- ☑ PERMANENT MARKER
- ☑ DRILL
- ☑ DRILL BITS 5/16
- ☑ HARDWARE BAG (INCLUDED)
- ☑ TORX, PHILLIPS, 10MM BOX
(TO REMOVE YOUR SPLASH GUARD, IF NECESSARY)

****CAUTION: PROFESSIONAL INSTALLATION IS STRONGLY RECOMMENDED****

1. Jack the front of the car for an easy access (don't forget to put your jack stands).
2. Align perfectly the lip under the bumper (the tip of the lip should be lined with the corner of your bumper near the wheel, see picture above).
3. With the permanent marker, mark the drill spot on the bumper through the holes of the lip (the lip should not move if you can't reach the bumper with your marker, skip to step #4).
4. Drill in the middle of your marks (or holes) with 5/16 drill bit.
5. Make an easy access to reach the holes inside the bumper. assemble the lip with hardware (see assembly instructions).
6. Put the lip on the bumper by aligning the bolts through the holes and add the lock nuts over the bolts inside the bumper.
7. Tight the bolts by the bottom of the splitter with you hex key.
8. Reinstall all removed trims and you're ready to rock n roll. take pictures and send them to info@artworkbodyshop.com and don't forget to tag us on social media [@artworkbodyshop](https://www.instagram.com/artworkbodyshop).