

Deb Tucker's  
Fundamental Tools

# Wing Clipper®

Basic Instructions

A Trim Down Tool for Traditional Flying Geese Units

High Precision

10 Different Size Units

Right Handed and Left Handed Instructions

Studio 180  
*Design*

Studio180Design.net

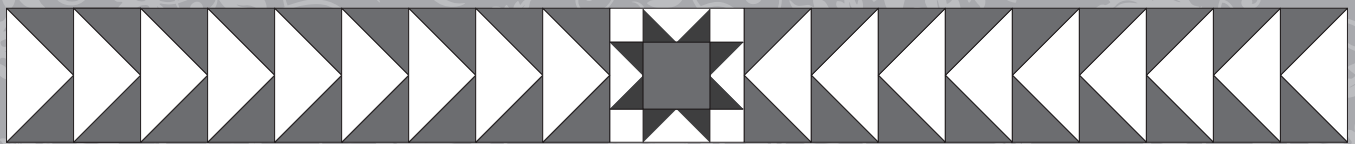

## Wing Clipper™ Basics

The **Wing Clipper**® is used to create traditional **Flying Geese units**. The finished size of these units will be twice as wide as they are tall. The construction method uses one large and four small squares to make four Flying

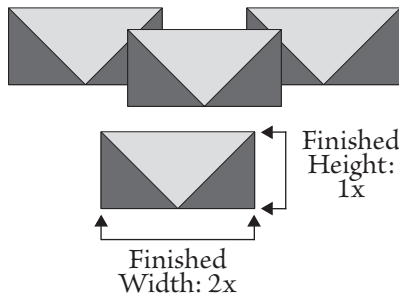

Geese at a time. The large square becomes the four large triangles in your Flying Geese, and the four smaller squares become the eight side triangles. Once the Flying Geese are sewn, the **Wing Clipper**® tool is used to trim each to its exact size, with the seams going directly into the corners. This is a terrific way to make precise units quickly and accurately!

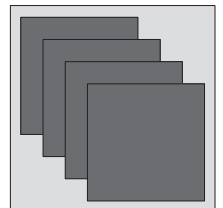

Finished Size of Flying Geese Unit	Cut Size of Flying Geese Unit	Cut Size of LARGE SQUARES Used to Make Large Quarter Square Triangles	Cut size of SMALL SQUARES Used to Make Small Half Square Triangles
½" x 1"	1 x 1½"	2½"	1½"
1" x 2"	1½" x 2½"	3½"	2"
1½" x 3"	2 x 3½"	4½"	2½"
2" x 4"	2½" x 4½"	5½"	3"
2½" x 5"	3" x 5½"	6½"	3½"
3" x 6"	3½" x 6½"	7½"	4"
3½" x 7"	4" x 7½"	8½"	4½"
4" x 8"	4½" x 8½"	9½"	5"
4½" x 9"	5" x 9½"	10½"	5½"
5" x 10"	5½" x 10½"	11½"	6"

## Flying Geese Construction Process

**Step 1 - Position** two of the smaller squares right sides together in diagonally opposite corners of the one large square. Nudge them in toward the center just a few threads.

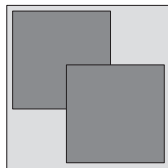

Step 1 - Position

**Step 3 - Stitch** on both of the drawn lines, then **Trim** between the lines of stitching on the center diagonal.

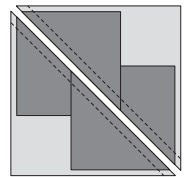

Step 3 - Stitch and Trim

If you have used this construction process in the past, it was critical to carefully align the raw edges of the small squares with the large square. For this process it is better to nudge the small squares closer toward the center of the large square and have about ⅛ of an inch showing between the raw edges of the small and large squares. After constructing a few, you'll know exactly how much to adjust.

**Step 4 - Press** seams toward the smaller triangles (I do this no matter which is dark or light).

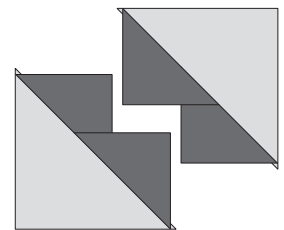

Step 4 - Press

**Step 2 - Mark** two lines, each ¼" away from the center diagonal. I like to use my **Quilter's Magic Wand™** and a fine line marking tool. The **Quilter's Magic Wand™** keeps my seam allowances from getting too wide and a fine line gives me better accuracy.

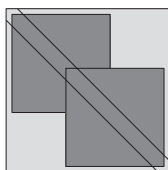

Step 2 - Mark

**Step 5 - Position** one small square in the corner of the previously pieced units. Nudge the squares in like you did before.

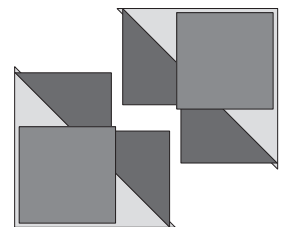

Step 5 - Position

**Step 6 - Mark** two lines, each  $\frac{1}{4}$ " away from the center diagonal. Use the **Quilter's Magic Wand™** and fine line marker.

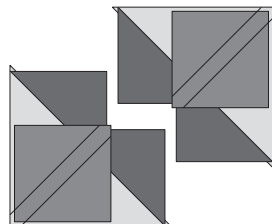

**Step 6 - Mark**

**Step 7 - Stitch** on both of the drawn lines, then **Trim** between the lines of stitching on the center diagonal.

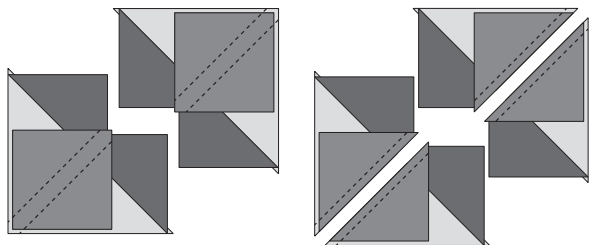

**Step 7 - Stitch and Trim**

**Step 8 - Press** seams toward the smaller triangles (I do this no matter which is dark or light).

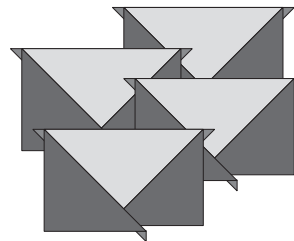

**Step 8 - Press**

At this point the pieced Flying Geese units are slightly larger than they need to be. You will use the **Wing Clipper®** to trim them to a precise measurement.

## Wing Clipper® Trim-Down Process Right Handed Quilters

**Step 9 - Position** your oversized units horizontally on your cutting mat with the long edge of the center triangle farthest away from you (in the "Valley" position).

**Step 10 - Align** the diagonal guide lines of the **Wing Clipper®** with the sewn seams of the Flying Geese unit. You'll automatically be centering the ruler over your pieced unit.

**Step 11 - Trim** up the right side and across the top of the **Wing Clipper®**, then rotate the Flying Geese unit 180° (half way around).

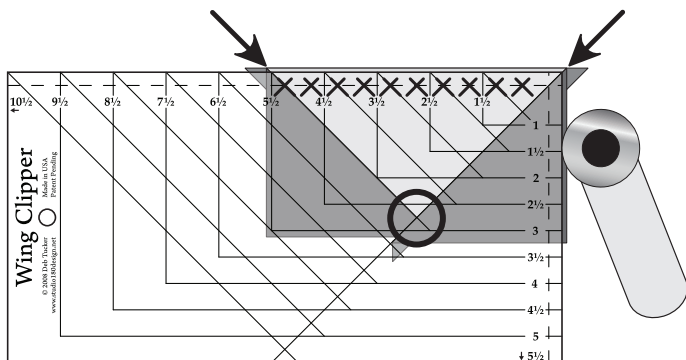

**Step 9 to 11 - Position, Align and Trim**

**Step 12 - Reposition** the **Wing Clipper®** to align clean-up guidelines with the previously trimmed raw edges and the "X" at the top with the intersection of the seams. Again be sure to have the proper cut sizes aligned for your particular project.

**Step 13 - Trim** again, up the right side and across the top. Each unit will now be precisely sized with all the seams properly positioned for perfect points every time.

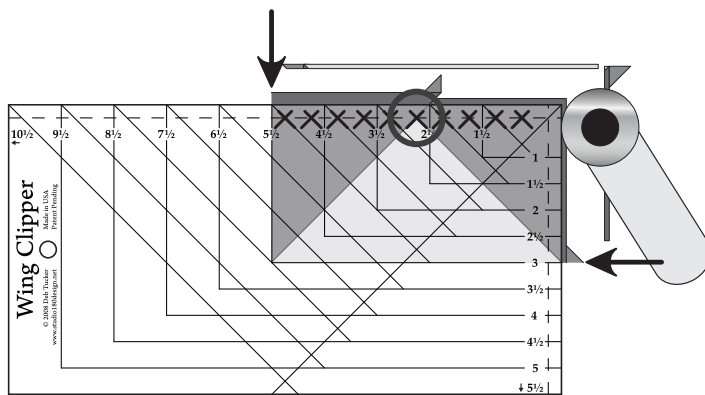

**Step 12 & 13 - Reposition and Trim Again**

To see an online video tutorial of the **Wing Clipper®** tool and others developed by Deb Tucker and **Studio 180 Design**, visit the video page on our website: [Studio180Design.net](http://Studio180Design.net)

## Left Handed Quilters

**Step 9 - Position** your oversized units vertically on your cutting mat with the long edge of the center triangle on the left as shown (with “the geese going East”).

**Step 10 - Align** the diagonal guide lines of the **Wing Clipper®** with the sewn seams of the Flying Geese unit. you'll automatically be centering the ruler over your pieced unit.

**Step 11 - Trim** up the left side and across the top of the **Wing Clipper®**, then rotate the Flying Geese unit 180° (half way around).

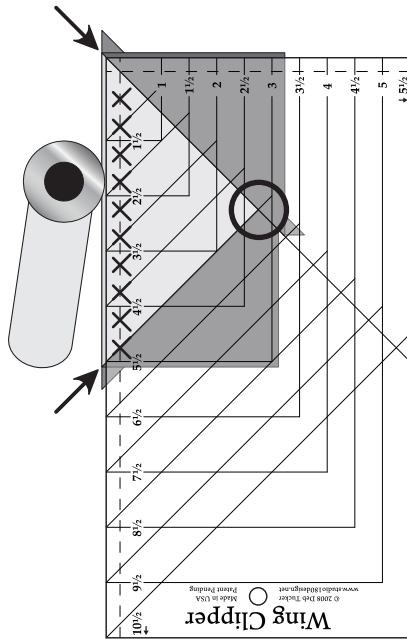

Step 9 to 11 -  
Position, Align and Trim

**Step 12 - Reposition** the **Wing Clipper®** to align the clean-up guidelines with the previously trimmed raw edges and the “X” at the top with the intersection of the seams. Again be sure to have the proper cut sizes aligned for your particular project.

**Step 13 - Trim** again, up the left side and across the top. Each unit will now be precisely sized with all the seams properly positioned for perfect points every time.

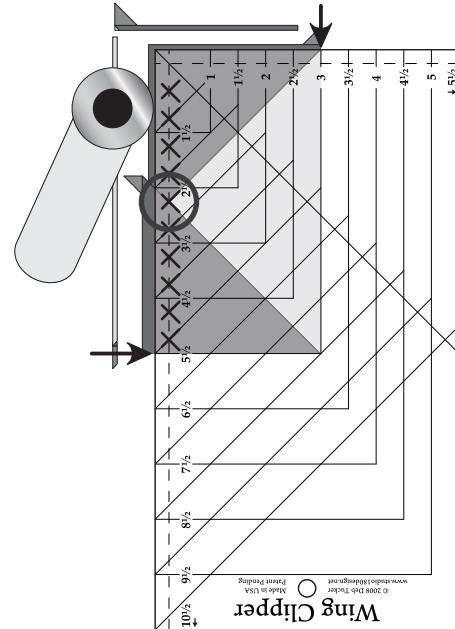

Step 12 & 13 -  
Reposition and Trim Again

## Additional Wing Clipper® Uses

To see additional ways to use your **Wing Clipper™** tool for making other units, be sure to check out our new **Technique Sheets** and companion video tutorials. The **Pickets and Quickets Technique Sheet** provides two methods to make a rectangular unit that looks like a Flying Geese unit with only one side triangle — like the Pickets on some Picket Fences. In both cases you make your unit oversized and trim to perfection with your **Wing Clipper™** ruler.