

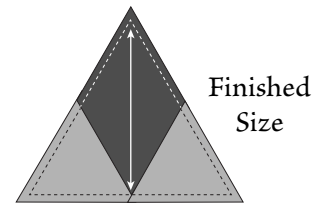

Are you ready to dive into the world of 60° quilting designs? Our Star 60™ tool brings the same concept of oversizing and trimming down into the realm of 60° shapes. We begin with a basic Star 60 unit, containing a diamond and two small triangles in 17 different size options, and then team this unit up with a multitude of additional shapes to create an array of amazing 60° quilt projects.

Of course, you will find all the same benefits you have come to expect from every Studio 180 Design tool. There are multiple size options, oversizing and trim down for better accuracy, fine lines for higher precision, right and left hand instructions, free videos, supporting patterns, incredible design options, ease of use with other patterns, and an increased success rate for every level quilt maker.



### Basic Unit

The Star 60 unit is made using one diamond (star point) and two equilateral triangles. When measuring the Star 60 units and referring to the finished height of the unit, it is measured from diamond point to diamond point.

### Tool Basics

Your new Star 60™ tool has four different areas for alignment and trimming.

- **Diamond Point Guidelines**
- **Flat Edge trim lines**
- **Horizontal Guidelines**
- **Vertical Guidelines**

The **Diamond Point Guideline** section has solid lines, broken lines, and numbers down the center of the tool. The solid lines are used to create whole inch Star 60 unit sizes, and the broken lines are used for the half inch unit sizes. All lines are engineered to precisely trim the diamond points of Star 60 units and are also used to cut the diamond shapes from strips. In addition, they act as guidelines for trimming other shapes.

The **Flat Edge trim lines** are the two outermost broken lines that intersect exactly ¼" from the base of the tool. They are used to precisely trim the stitched edge of the Star 60 unit, leaving the necessary ¼" seam allowance beyond the stitched intersection.

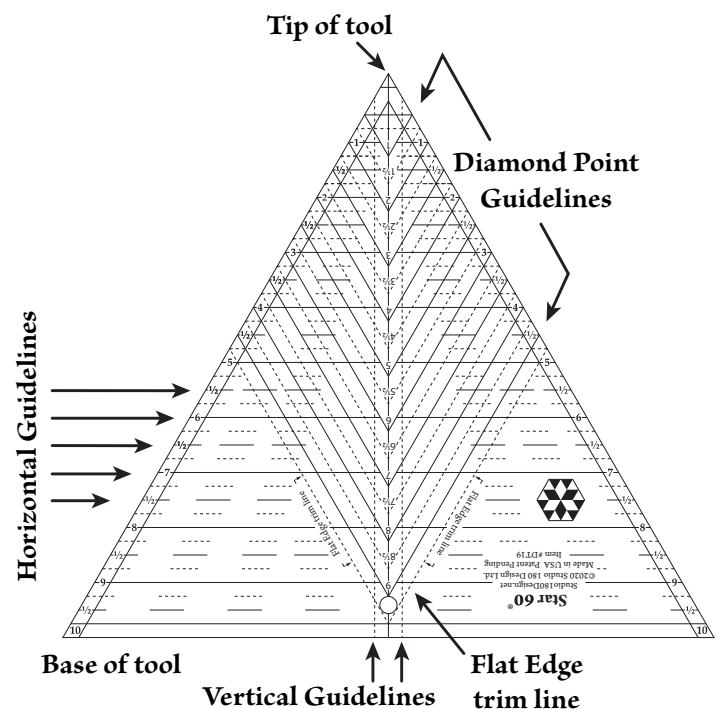

The **Horizontal Guidelines** are both solid and broken lines that run parallel to the base of the tool. They are used to cut and trim triangles, hexagons and half hexagons. The numbers along the edges are in whole inch, half inch and quarter inch increments.

The **Vertical Guidelines** are the three lines running north and south through the center of the tool. The solid line runs directly through the center of the tool and the two broken lines are each 1/4" away from the center line. They are most often used to cut the setting triangles required to square off edges of triangles and hexagons.

## Basic Shape Cutting Chart

When dealing with 60° piecework, there are a number of basic shapes used on a regular basis. Most of these shapes can be cut from strips or rectangles. The cutting charts provide the information you will need to determine what size strips or rectangles to cut for the 17 different size options available on the tool.

To use the chart, first determine the desired finished size of your unit, then follow the row across for the strip size for the shape you want to cut. Some of the columns will give you information for cutting shapes for precision piecework and others for oversizing to allow for trim down. These options allow you to use your Star 60 tool with other designers' patterns.

Star 60 Finished Unit Size	Diamond Strips (Oversized)	Diamond Sub-cut Guideline	Side Triangle Strip (Oversized)	Companion Triangle Strip (Oversized)	Companion Triangle Strip (Precision)	Half Triangle Rectangles (Oversized)
1"	1 1/4"	2"	1 1/2"	2"	1 1/2"	2" x 2"
1 1/2"	1 1/2"	2 1/2"	1 3/4"	2 1/2"	2"	2 1/2" x 2 1/2"
2"	1 3/4"	3"	2"	3"	2 1/2"	2 3/4" x 3"
2 1/2"	2"	3 1/2"	2 1/4"	3 1/2"	3"	3" x 3 1/2"
3"	2 1/4"	4"	2 1/2"	4"	3 1/2"	3 1/4" x 4"
3 1/2"	2 1/2"	4 1/2"	2 3/4"	4 1/2"	4"	3 1/2" x 4 1/2"
4"	2 3/4"	5"	3"	5"	4 1/2"	3 3/4" x 5"
4 1/2"	3"	5 1/2"	3 1/4"	5 1/2"	5"	4" x 5 1/2"
5"	3 1/4"	6"	3 1/2"	6"	5 1/2"	4 1/2" x 6"
5 1/2"	3 1/2"	6 1/2"	3 3/4"	6 1/2"	6"	4 3/4" x 6 1/2"
6"	3 3/4"	7"	4"	7"	6 1/2"	5" x 7"
6 1/2"	4"	7 1/2"	4 1/4"	7 1/2"	7"	5 1/4" x 7 1/2"
7"	4 1/4"	8"	4 1/2"	8"	7 1/2"	5 1/2" x 8"
7 1/2"	4 1/2"	8 1/2"	4 3/4"	8 1/2"	8"	5 3/4" x 8 1/2"
8"	4 3/4"	9"	5"	9"	8 1/2"	6" x 9"
8 1/2"	5"	Flat Edge Trim Line	5 1/4"	9 1/2"	9"	6 1/4" x 9 1/2"
9"	5 1/4"	Regular Ruler with 5 1/4" Line	5 1/2"	10"	9 1/2"	6 1/2" x 10"

## Star 60 Unit

To make one Star 60 unit you will need to cut 1 diamond and 2 side triangles.

### Cutting the Diamonds

**Step 1** - In the chart, find the row for your desired finished unit size. Follow the row across until you find the column labeled **Diamond Strips (Oversized)**. Cut a strip that size by width of fabric. Open the strip and lay one or more of them right side up on the cutting mat. Trim one short edge at a 60° angle as shown. For example, to make a 2" finished unit cut a strip 1 3/4".

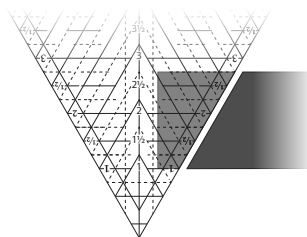

Right Handed

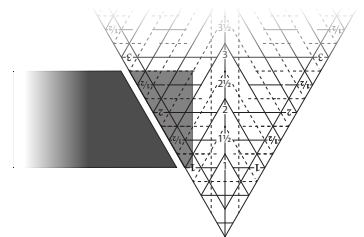

Left Handed

Step 1 - Cut

**Step 2 -** Locate the **Diamond Sub-Cut Guideline** in the next column for your desired finished size. Align those guidelines with the raw edges of the strip and the angled cut just made as shown in the diagram. Cut along the leading edge of the tool to create oversized diamond shapes. For example, for a 2" finished Star 60 unit find the 3" Diamond Point Guidelines and align them with the strip edges and cut. Continue cutting in the same manner until you have all the diamonds needed.

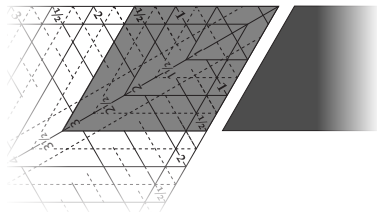

**Right Handed**

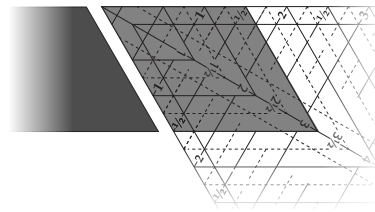

**Left Handed**

**Step 2 - Cut**

To cut the diamonds for the 9" finished unit a regular ruler is needed. Follow step 1 to set the 60° angle, then align the 5¼" line of your regular ruler with the angled edge of the strip and cut. Continue cutting 5¼" slices, frequently checking your 60° angle until you have the desired number of diamonds.

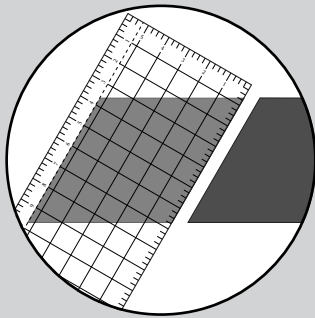

**Right Handed**

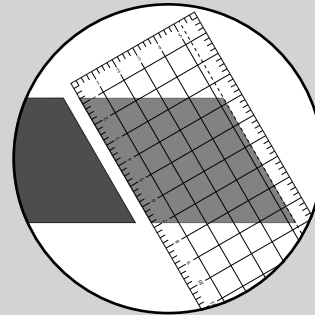

**Left Handed**

**Cutting the Side Triangles**

**Step 3 -** Follow the row for your finished block size over to the column labeled **Side Triangle Strip (Oversized)**. Cut a strip that size by width of fabric. Position the strip, either folded or open, on your cutting mat with the tool on top as shown in the diagram below. Align the mark near the tip of the tool with the top of the strip and the horizontal line on the tool that corresponds to the width of the strip on the bottom edge of the strip. For example, if making a 2" finished unit you will cut a strip 2" wide and align the 2" horizontal line on the tool with the bottom edge of the strip.

**Step 4 -** To cut, right handed quilters will cut from left to right. Left handed quilters will cut from right to left. Cut up one side of the tool and down the other.

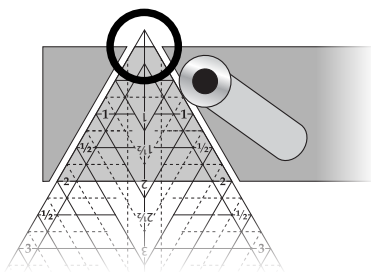

**Right Handed**

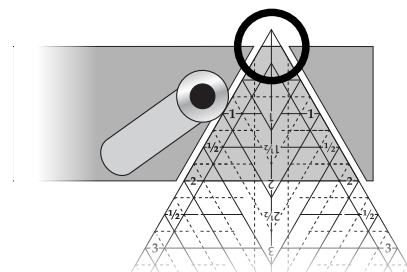

**Left Handed**

**Steps 3 & 4 - Position and Cut**

**Step 5** - Rotate the Star 60™ tool 180° so that the sharp point is closest to you. Align the same tool guidelines used previously with the upper edge of your strip. Also align one edge of the tool with the previously trimmed edge. Cut the next triangle shape from the strip. Continue rotating, aligning, and cutting until you have all the triangles you need for your project.

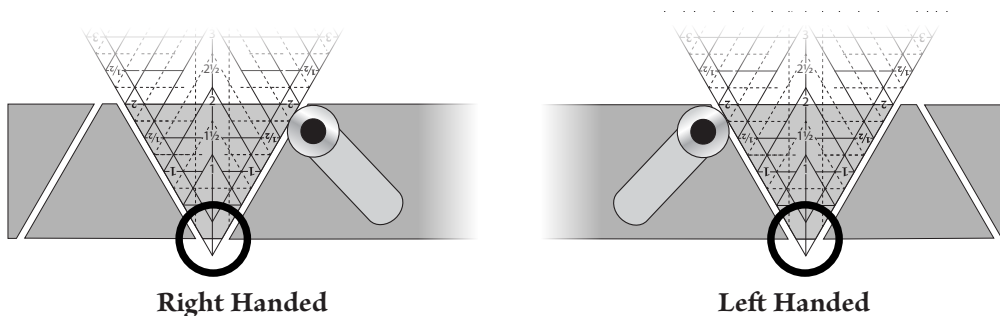

**Step 5 - Cut**

### Piecing the Star 60 Unit

**Step 6** - Lay out the diamonds and triangles as shown. We like to place the straight of grain along the top edge for stability.

**Step 7** - Take a triangle from the right hand side and position it on top of the diamond. Match the flat corner of the triangle with the edge of the diamond as shown; align the raw edges.

**Step 8** - With the diamond on top, stitch along the matched edges with a ¼" seam. Press the seam toward the diamond or open.

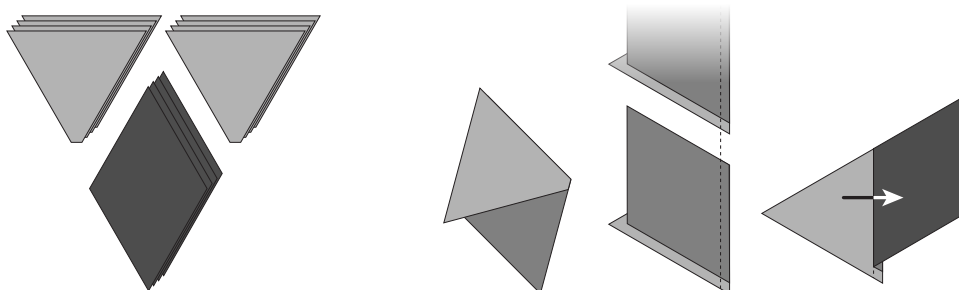

**Step 6 - Lay out**

**Steps 7 & 8 - Stitch and Press**

**Step 9** - Position a remaining triangle on the other side of the diamond point. Align the flat corner of the triangle with the edge of the diamond. Align the raw edges.

**Step 10** - With the diamond on top, stitch with a ¼" seam. Press the seam toward the triangle or open.

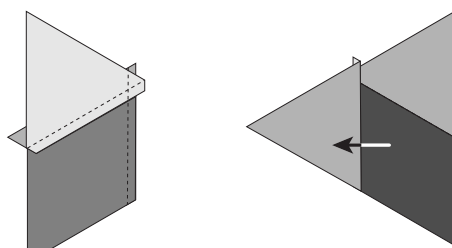

**Steps 9 & 10 - Position, Stitch, and Press**



The Star 60 unit is complete but oversized. It is in need of trimming on all 3 sides.

### Trimming Star 60 Units to Precision

Depending on the orientation of the unit within the block, you may want to trim just the point, just the flat end, or possibly all three sides. Decide how you are going to use the unit before you proceed to trimming. The instructions that follow are for trimming all three edges to create a high precision unit.

**Step 11 - Trimming the Diamond Point.** Use the **Star 60™** tool to trim each Star 60 unit to an exact size. Position the pieced unit right side up on the cutting mat. Righties point the diamond toward the 2 o'clock position, and lefties point the diamond toward the 10 o'clock position. Align the desired finished size Diamond Point Guidelines with the sewn seams. Trim along both sides of the ruler. For example, if making a 2" finished unit, you will align the solid lines above the number 2 with your seam lines.

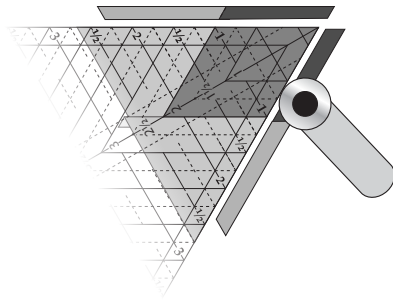

**Right Handed**

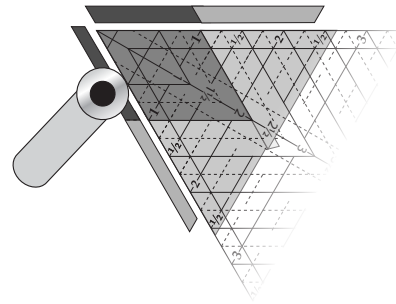

**Left Handed**

**Step 11 - Trim**

**Step 12 - Trimming the flat end.** Rotate the unit so that the untrimmed edge is either by your right hand for trimming if you are right handed or by your left hand if left handed. Locate the **Flat Edge trim line** on the **Star 60™** Tool. Align the **Flat Edge trim lines** with the seams of the Diamond. This trim gives you a perfectly trimmed Star 60 unit that, in our example, will finish to 2". At this point, we like to trim the remaining dog ear to help reduce bulk.

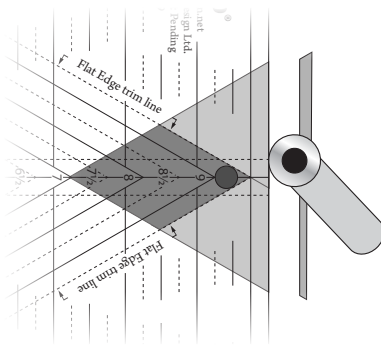

**Right Handed**

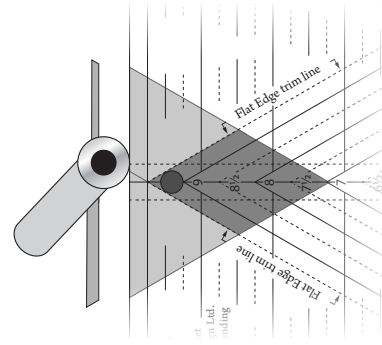

**Left Handed**

**Step 12 - Trim**

**Add a Companion Triangle to Your Star 60 Unit**

Many designs can be created by mixing and matching the Star 60 unit with other 60° shapes, including unpieced 60° triangles that we call Companion Triangles. Usually, we add oversized Companion Triangles to untrimmed Star 60 units to allow for future trimming, but sometimes it is best to use precision size Companion Triangles. All strip sizes for both techniques are listed in the chart for all 17 sizes.

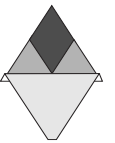

To cut these Companion Triangles, you will follow the same process you used to cut the Side Triangles.

**Step 13 -** Locate your desired finished unit size on the chart and follow that row over to the column labeled **Companion Triangles Strip (Oversized)**. Cut a strip that size, then follow steps 3-5 above to cut the number of Companion Triangles that you need. As with the side triangles, the horizontal line on the tool that corresponds to the width of your strip will align with the bottom of the strip. For example, to cut an oversized Companion Triangle to go with the 2" finished Star 60 unit, find the 2" Finished unit row on the chart and follow it over to see that you need a 3" strip. Cut a 3" strip, align the 3" horizontal guideline on the tool with the bottom of the strip and the line near the tip of the tool with the top of the strip.

**Step 13a** - To add the Companion Triangle (Oversized) to an untrimmed Star 60 unit, you will need to trim that side of the Star 60 unit first. Use step 11 or 12 to trim the appropriate side. Only trim one side at this time. Center the Star 60 unit against one edge of the Companion Triangle and align the edges. Stitch with a  $\frac{1}{4}$ " seam with the Star 60 unit on top. Press open or toward the Companion Triangle.

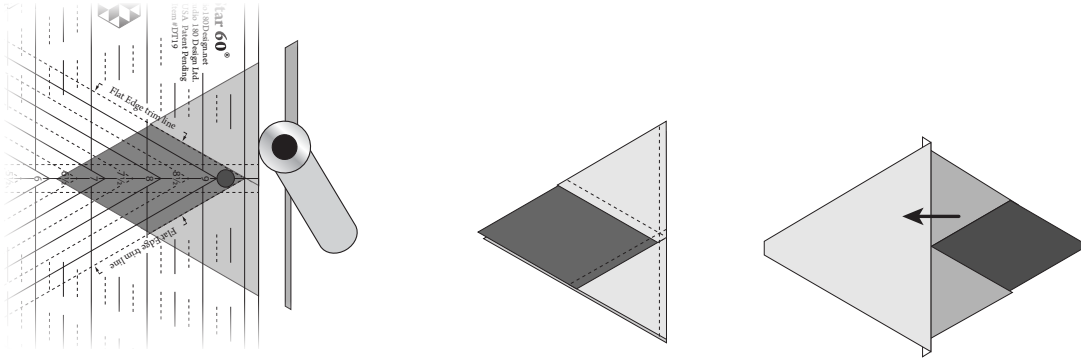

**Step 13a - Trim, Stitch, and Press**

**Step 13b** - Trim the Star 60 end of the expanded unit by placing the tip of the Diamond Point Guidelines for the unit size you are working with on the center seam and align the Diamond Point Guidelines with the seam(s) of the diamond coming from that center point.

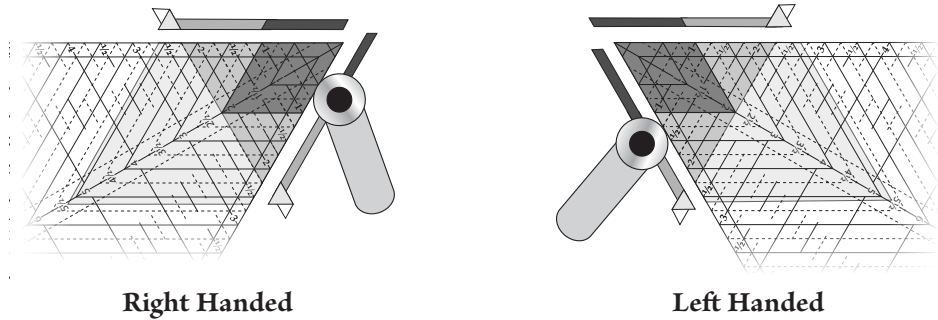

**Step 13b - Trim**

**Step 13c** - **Rotate** the expanded unit to trim the attached oversized companion triangle.

Place the same Diamond Point Guidelines as those used in the previous step, tip to tip with the Star Point 60° diamond, and the Horizontal Guidelines on the center seam. For our example, the 2" Diamond Point Guidelines will be tip to tip with the diamond.

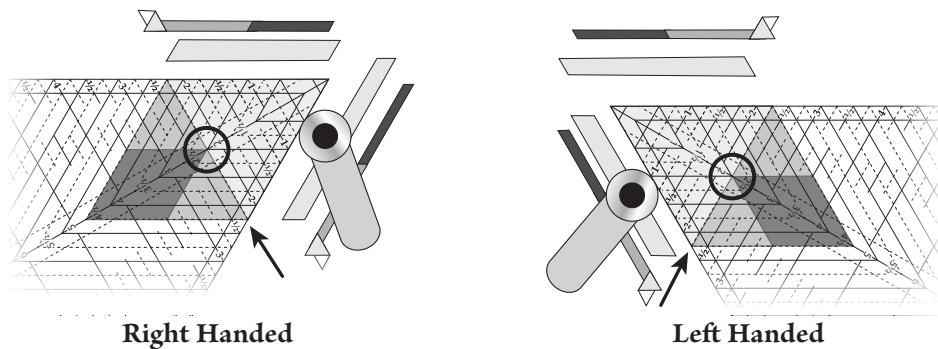

**Step 13c - Rotate and Trim**

In some designs, you might find it beneficial to work with precision units. If so, you will need to trim all sides of the Star 60 unit and cut the Companion Triangle using the precision size listed in the chart. Align the units on all edges and stitch with a  $\frac{1}{4}$ " seam. Press as desired. **No excess is added so trimming to clean up the edges should be avoided.**

## Hexagons from Star 60 Units

Hexagon sizes are measured from flat edge to flat edge through the exact center of the shape.

When making a hexagon from Star 60 units, you will be creating a finished hexagon shape that is twice the size of the starting Star 60 unit. So, if you are working with 2" finished Star 60 units, your hexagon will finish at 4".

Conversely, if you wish to make a hexagon a specific size using Star 60 units, you will need to create finished size Star 60 units that are half the size of the finished size hexagon. For example, if you wish to end up with a 9" finished hexagon, you will need to create 4½" finished Star 60 units.

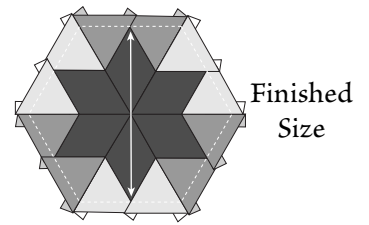

**Step 14** - Determine the desired finished size of your hexagon. Divide the finished size by two to determine the finished size Star 60 unit required. For example, to make a 4" finished hexagon, you would need to work with 2" finished Star 60 units.

**Step 15** - Create six Star 60 units following steps 1 - 10.

**Step 16** - Trim just the diamond point of each Star 60 unit using the Diamond Point Guidelines, 2" in the example above. **Do not trim the flat edge of the unit at this time.**

**Step 17** - Lay out your Star 60 units into a hexagon. Refer to the diagram for reference.

**Step 18** - Take two units that are next to each other and position them right sides together. Align the trimmed edges and match the points. The seams will nest or match depending on your pressing. Stitch along one edge with a ¼" seam and press the seam open.

**Step 19** - Position the sewn pair back into your hexagon layout. Take one additional unit and add it to the pair right sides together. Align the edges and match the seam intersection. The point will also align with the dog ear of the pair of sewn units.

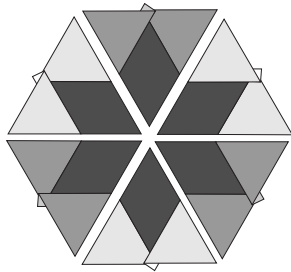

**Step 17 - Lay out**

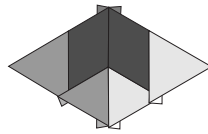

**Step 18 - Stitch and Press**

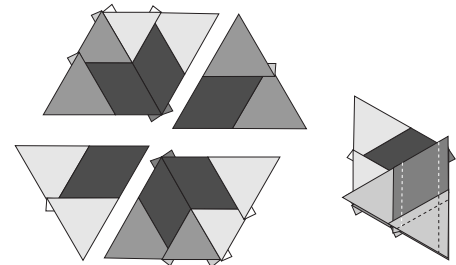

**Step 19 - Position and Stitch**

**Step 20** - Stitch with a ¼" seam and press the seam open. Repeat steps 18-20 for the other half of the hexagon. You now have two sections containing 3 units each.

**Step 21** - Position the two halves together to make a whole hexagon. Align the center, seam intersections, and raw edges. Pin together. Stitch. Press seams open.

**Step 22** - To trim the hexagon, you will need to make 4 trims. Locate the Diamond Point Guidelines for the finished size of your hexagon. This is double the size of your Star 60 unit. For example, you made 2" finished Star 60 units so that means you need to locate the 4" Diamond Point Guidelines.

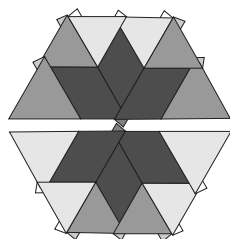

**Step 20 - Stitch and Press**

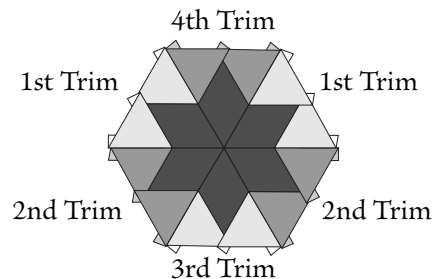

**Step 22 - Trim**

**Step 23** - Position the Diamond Point Guidelines in the center of the hexagon. Align the guidelines with the seams of your Star 60 units. Align the Horizontal Guidelines with the center seam to insure proper orientation. The Diamond Points on the edge units should be on or inside the ¼" line on the edge of the tool. In our example, you would position the tip of the 4" Diamond Point Guideline in the center and align the Diamond Point Guidelines with the seams. Also align the 4¼" horizontal line with the horizontal center seam.

**Step 24** - Trim the first two sides of the hexagon. Orient the block and tool for comfortable cutting.

**Step 25** - Rotate the hexagon 180° and align the same guidelines as in step 23. Trim the second two sides.

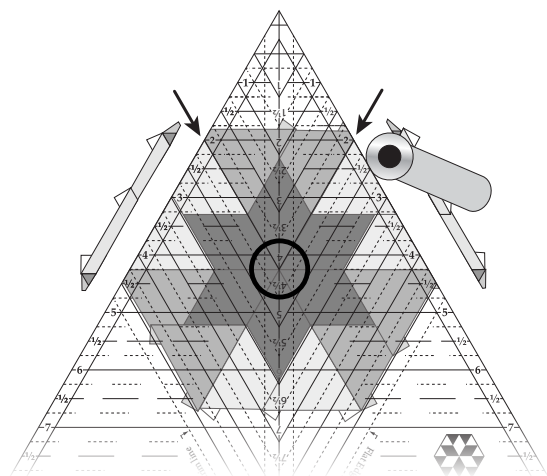

**Step 24 - Trim First Sides**

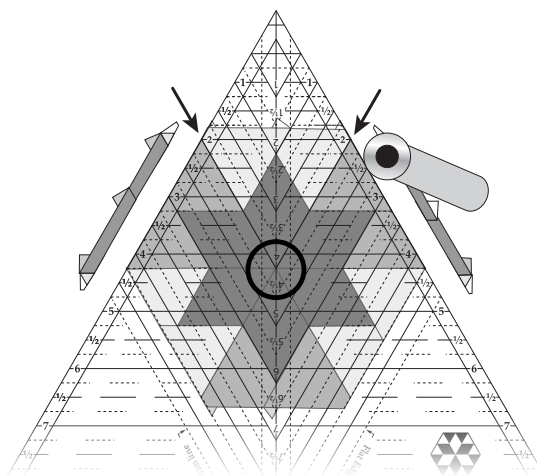

**Step 25 - Rotate and Trim Second Sides**

**Step 26** - To make the third and fourth trims, you will need to use the **Flat Edge trim line**. Locate one of the untrimmed edges and align the **Flat Edge trim lines** as in step 12. Make sure that as you align the horizontal guidelines, you also center the vertical line through both the center of the block and the opposite star point. Also note that many other lines will align with the seams. Trim along the flat edge of the tool. Repeat for the remaining untrimmed edge.

You now have a perfectly trimmed hexagon made up of Star 60 units.

### Expanding your Hexagons

Many of our favorite designs are created by adding Companion Triangles to the hexagon shape to create large pieced triangles. To do this, you will need to determine which three sides you will be adding triangles to, and trim those three edges using the **Flat Edge trim line** as shown in step 26.

Cut the oversized Companion Triangles according to the chart for the same size as your Star 60 unit. For example, if you used 2" Star 60 units to create your pieced hexagon, you would use the 2" Finished Unit Size row, and cut your oversized Companion Triangles from a 3" strip.

**Step 27** - Center each oversized Companion Triangle on the trimmed edges and stitch with a 1/4" seam. Press the seam toward the Companion Triangle. To trim this triangle unit, locate the Diamond Point Guideline for your hexagon's finished size, place that in the center of the pieced hexagon and align the seams of the hexagon with the guidelines. A horizontal guideline will align with the seam between the Companion Triangle and the Star 60 unit.

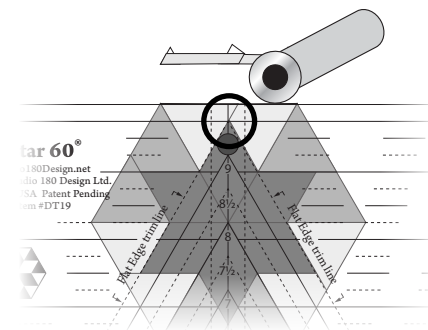

**Step 26 - Trim Third Side, Rotate, and Trim Fourth Side**

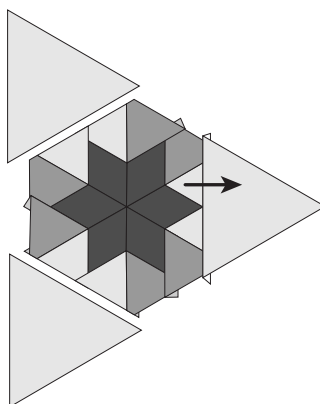

**Step 27 - Stitch and Press**



Trim on two sides of the tool to about the half way point on each side of the triangle. Rotate the block and trim the remaining two points using the same lines and methods. For example, if you used a 2" Star 60 unit to make a 4" finished pieced hexagon, you will locate the 4" Diamond Point Guidelines and align them with the center of your hexagon and with the seams. The 2¼" horizontal guidelines will align with the seam between the Star 60 unit and companion triangle.

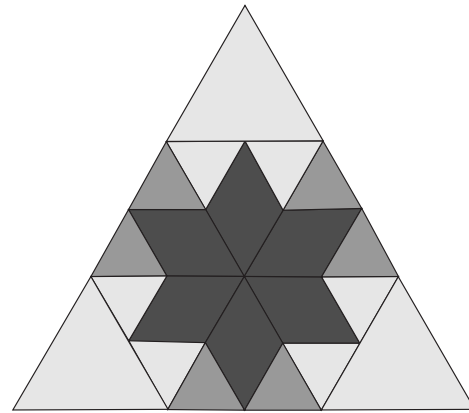
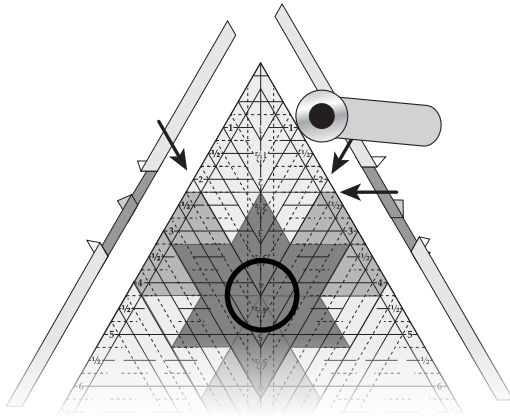

Step 27 - Trim

## Cutting Precision Hexagons

You can also use the Star 60 tool to cut hexagons either from strips or rectangles. You can cut hexagons from 2" to 9" finished height.

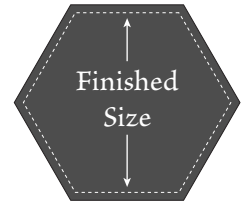

### Hexagon Cutting Chart

Hexagon Finished Height (Size)	Hexagon Unfinished Height	Strip Width (Precision)	Horizontal Guideline Placed on Fold	Rectangle Size (Precision)
2"	2½"	2½"	2¼"	2½" x 3¼"
2½"	3"	3"	2¾"	3" x 3¾"
3"	3½"	3½"	3¼"	3½" x 4½"
3½"	4"	4"	3¾"	4" x 5"
4"	4½"	4½"	4¼"	4½" x 5½"
4½"	5"	5"	4¾"	5" x 6¼"
5"	5½"	5½"	5¼"	5½" x 6¾"
5½"	6"	6"	5¾"	6" x 7¼"
6"	6½"	6½"	6¼"	6½" x 7¾"
6½"	7"	7"	6¾"	7" x 8½"
7"	7½"	7½"	7¼"	7½" x 9"
7½"	8"	8"	7¾"	8" x 9½"
8"	8½"	8½"	8¼"	8½" x 10"
8½"	9"	9"	8¾"	9" x 10¾"
9"	9½"	9½"	9¼"	9½" x 11¼"

**Step 28** - Locate your desired finished hexagon size in the chart. Follow that row over to either the **Strip Width (Precision)** or **Rectangle Size (Precision)** and cut a strip or rectangle that size. For example, if cutting a 4" finished Hexagon cut a strip 4½" or a rectangle 4½" x 5½".

**Step 29** - Fold the strip or rectangle in half right or wrong sides together. The fold should run parallel to the longest sides of the rectangle.

**Step 30** - In the chart, find the **Horizontal Guideline Placed on Fold** column for the hexagon size you are making. Locate that horizontal line on the **Star 60™** tool.

**Step 31** - Place the indicated horizontal line on the fold of the fabric. Cut along both edges of the tool. This creates a precision hexagon that you can use in piecing quilts or to make blocks.

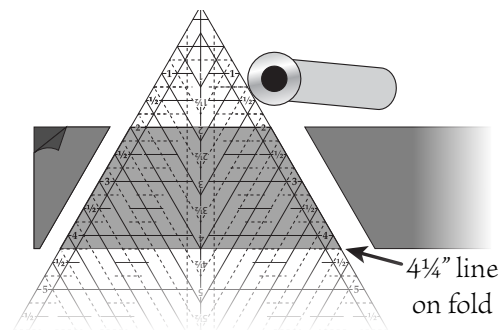

**Steps 29-31 - Position and Cut**

## Working with Half Hexagons

In many situations you will be working with half hexagons rather than full hexagons to eliminate “Y” seam construction and construct your quilt in rows.

To piece 3 Star 60 units into half hexagon units follow steps 14-20, then trim the half hexagon following steps 22-24. Use step 26 to trim the final edge.

Once you have pieced your Star 60 units into a half hexagon, you can stitch the pieced half hexagon to an unpieced half hexagon. To cut half hexagons from strips use the chart and steps below.

**Step 32**- Determine what size finished half hexagon you need, and if it is a precision or oversized half hexagon. Once you have determined the size and type that you need, locate the strip or rectangle size in the chart and cut that from your fabric.

## Half Hexagon Cutting Chart

Note: The half hexagon size is the same as the Star 60 unit size.

Half Hexagon Finished Height	Strip Width (Oversized)	Bottom Horizontal Line (Oversized)	Single Rectangle Size (Oversized)	Strip Width (Precision)	Bottom Horizontal Line (Precision)	Single Rectangle Size (Precision)
1"	1 3/4"	3"	1 3/4" x 4"	1 1/2"	2 1/2"	1 1/2" x 3 1/2"
1 1/2"	2 1/4"	4"	2 1/4" x 5 1/4"	2"	3 1/2"	2" x 4 1/2"
2"	2 3/4"	5"	2 3/4" x 6 1/4"	2 1/2"	4 1/2"	2 1/2" x 5 3/4"
2 1/2"	3 1/4"	6"	3 1/4" x 7 1/2"	3"	5 1/2"	3" x 6 3/4"
3"	3 3/4"	7"	3 3/4" x 8 3/4"	3 1/2"	6 1/2"	3 1/2" x 8"
3 1/2"	4 1/4"	8"	4 1/4" x 9 3/4"	4"	7 1/2"	4" x 9 1/4"
4"	4 3/4"	9"	4 3/4" x 11"	4 1/2"	8 1/2"	4 1/2" x 9 3/4"
4 1/2"	5 1/4"	10"	5 1/4" x 12 1/4"	5"	9 1/2"	5" x 11 1/2"

**Step 33** - Position the strip or rectangle on the cutting mat and position the **Star 60™** tool on the fabric with the point away from you. Determine your **Bottom Horizontal Line** from the chart and align that with the bottom edge of your strip or rectangle. Let's say you want a 2" finished half hexagon and you are going to cut it oversized. Cut a strip 2 3/4" x wof, lay the 5" horizontal line along the bottom of the strip.

**Step 34** - Cut on both sides of the tool to create the half hexagon. To cut a second half hexagon when you are working with strips, rotate the tool 180° and align the horizontal guideline for your selected size along the top of the strip (5", in our example). Cut on the next side. Continue rotating and cutting until you have all the half hexagons that you need.

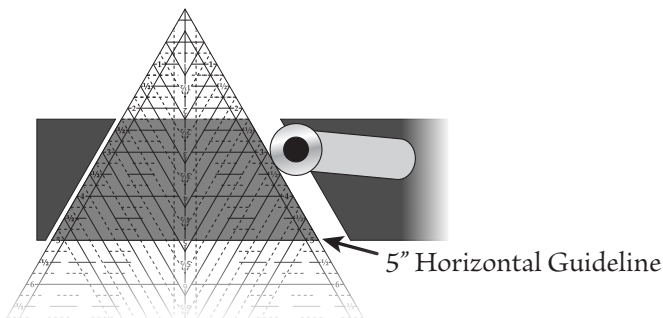

**Step 33 - Position and Cut**

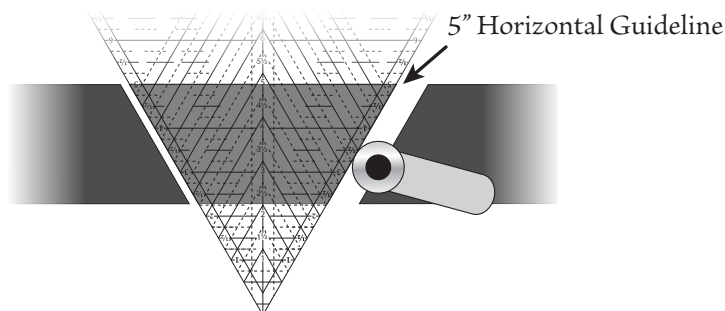

**Step 34 - Rotate and Cut Again**

## Working with Half Triangles

In many cases, you will want to square off the edges of your blocks and quilts. To do this, we recommend adding oversized half triangles to the ends of your rows. You will be cutting these shapes from rectangles. You will usually need mirror image triangles to finish off the rows, so remember to cut two rectangles the same size and place them right or wrong sides together.

**Step 35** - Determine what size Half Triangles you need. If your rows are made of half hexagons or Star 60 units, find the finished size for your Star 60 unit and follow that row in the Basic Shape cutting chart on page 1 to the column labeled **Half Triangle Rectangles (Oversized)**. Cut two rectangles the size listed. For example, with a 2" Star 60 unit you will cut two rectangles 2 $\frac{3}{4}$ "x 3".

**Step 36** - Layer the rectangles right or wrong sides together and set them on your cutting mat so that the longest measurement is vertical and the shorter measurement is horizontal. Place the center solid line on your tool on the longest edge of your rectangle and the  $\frac{1}{2}$ " line on the top of the rectangle as shown.

**Step 37** - Cut along the edge of your tool. You now have four Half Triangles that you can use to finish off your rows.

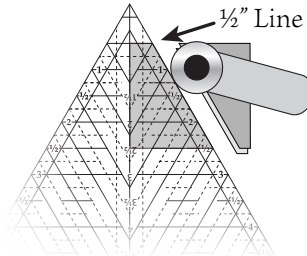
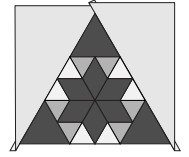
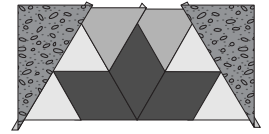

Step 37 - Cut

## Additional Setting Pieces

Often when building blocks and piecing them into rows, the rows become wider than 9" finished (9 $\frac{3}{4}$ " unfinished), which is the largest size in our chart. If your row ends up measuring more than 9 $\frac{3}{4}$ ", follow these steps to calculate the size rectangles you will need to cut for your setting pieces. If you are unsure about your calculations as you go through these steps, remember you can always cut your rectangles even larger and trim them down once you have them pieced on your rows.

**Step 38** - Measure the height of your row and add 2" to this measurement. For example, your row measures 12 $\frac{3}{4}$ " in height, then the height of your rectangle will be 14 $\frac{3}{4}$ ".

**Step 39** - To figure out the width of your rectangle, measure from point to point on your block and divide that measurement by 2, then add 2" to that number. For example, 12" finished triangle block measures 14 $\frac{3}{4}$ " from point to point. Divide this by 2 to get 7 $\frac{3}{8}$ ", so the width of your rectangle will be 9 $\frac{3}{8}$ " or 9 $\frac{1}{2}$ " for easier cutting. For example, for your 12" finished (12 $\frac{3}{4}$ " unfinished) blocks you want to cut your rectangles 9 $\frac{1}{2}$ "x 14 $\frac{3}{4}$ ".

**Step 40** - Cut 2 rectangles the size you calculated, make sure they are right or wrong sides together, align the  $\frac{1}{2}$ " line on the tool with the top edge and the center line with the edge of the rectangle, place a regular ruler next to the Star 60 tool. Move the Star 60 tool out of the way and cut along the edge of your long ruler.

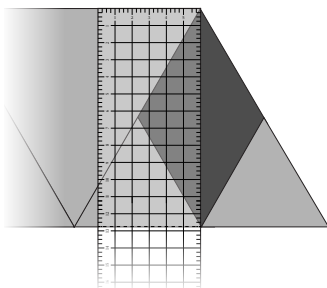

Step 38 - Measure Height

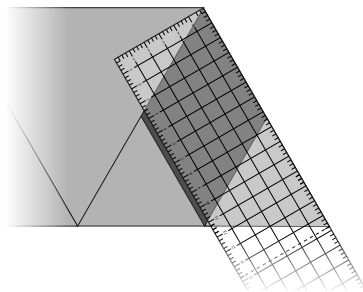

Step 39 - Measure Long Side

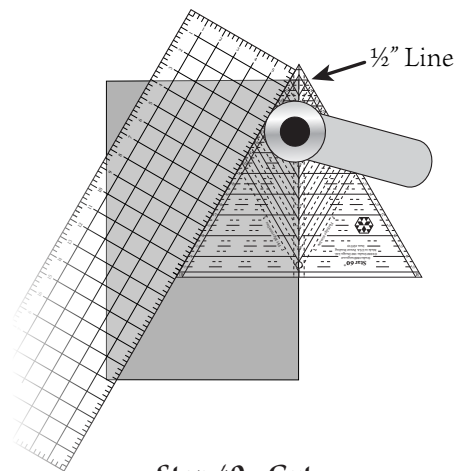

Step 40 - Cut

## Block Suggestions

Below are some possible block combinations to get your creativity flowing.

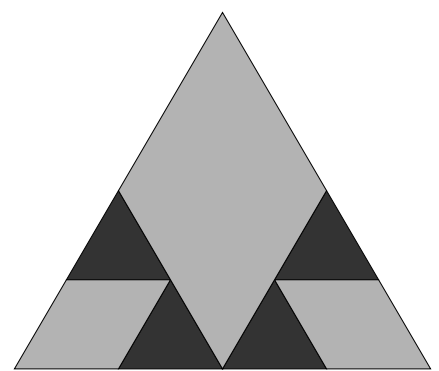
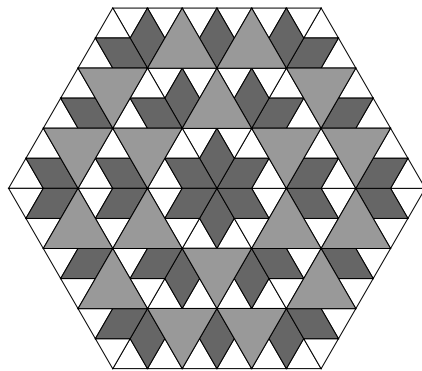
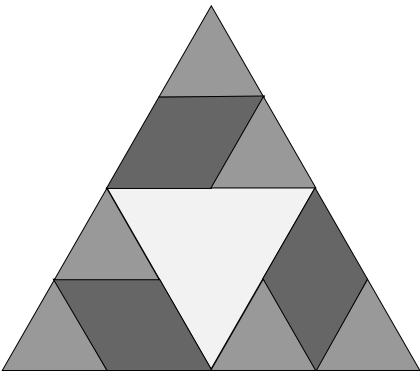
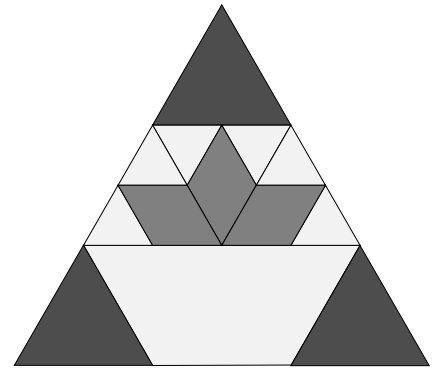
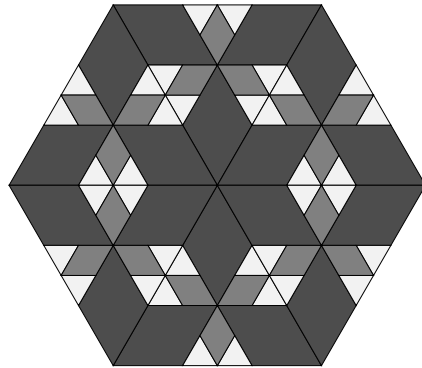
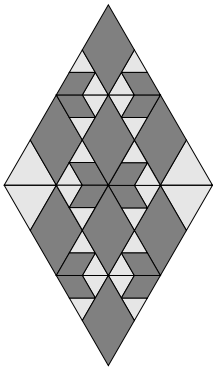
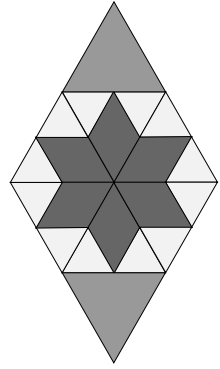
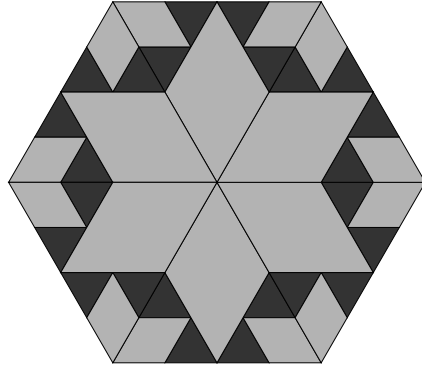
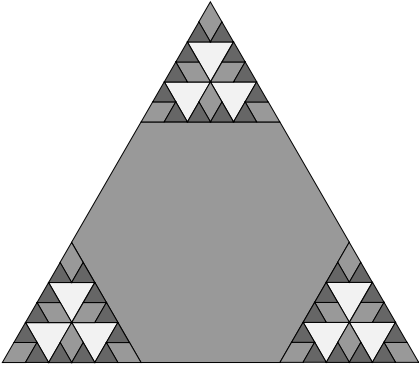

# Hextravaganza

**Finished Size:** 17 options from 6"x 7" up to 54"x 62<sup>3</sup>/<sub>8</sub>" (without borders)

Now that you know the basics of the Star 60™ tool, why not give our free project a try? The quilt size and fabric yardage will, of course, depend on the size blocks you choose. Below is a listing of the pieces you will need to make and cut for the *Hextravaganza* project.

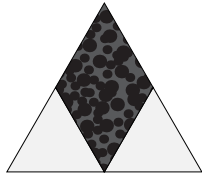

## Star 60 Units

*Color 1 & Background*

Make 18

18 Diamonds

36 Side Triangles

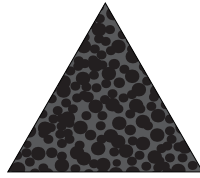

## Companion Triangles

*Color 1*

Cut 9



## Half Triangles

*Setting Color*

Cut 2 rectangles

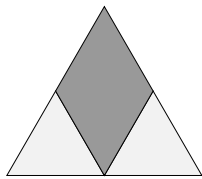

## Star 60 Units

*Color 2 & Background*

Make 18

18 Diamonds

36 Side Triangles

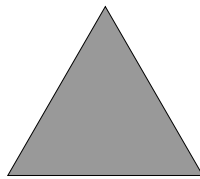

## Companion Triangles

*Color 2*

Cut 9



## Framing Strips

*Setting Color*

Cut 2

**Step 1** - Figure out what size Star 60 units you want to use in your project. Consult the chart on page 2 for the strip sizes you will need to cut for your Star 60 units and follow steps 2-10 for making your star 60 units. Consult our free downloadable chart to determine how many of each diamond, triangle, and rectangle shape you can cut from each strip for your unit size.

**Step 2** - Follow the chart row over for your chosen unit size to the **Companion Triangles (Oversized)**. Cut the triangles using steps 4 and 5.

**Step 3** - Construct hexagons using the Star 60 units, following steps 16 - 26.

**Step 4** - Add the companion triangles to the Star 60 hexagon to create your pieced triangle. Trim the triangle block to size following step 27.

**Step 5** - Measure your block and determine your setting **Half Triangle Rectangle Size** using the chart on page 1 and steps 35-37 or steps 38-40 if your block measures more than 9<sup>3</sup>/<sub>4</sub>" in height.

**Step 6** - Lay out the pieced triangles and stitch them together into a hexagon. Press the seams open as you go. Stitch the Setting Half Triangles onto the sides of the hexagon. See the layout diagram on page 14.

**Step 7** - Square up the center. Trim the Setting Half Triangles even with the edge of the hexagon. Square up the sides so that the edge is <sup>1</sup>/<sub>4</sub>" or more beyond the point. Add framing strips the width you desire to the two sides to float the hexagon.

**Step 8** - Pick how many borders you want to add, one, two or more. Finish as you desire.

The full Hextravaganza sub-cutting chart can be found on our website:  
**Studio180Design.net.**



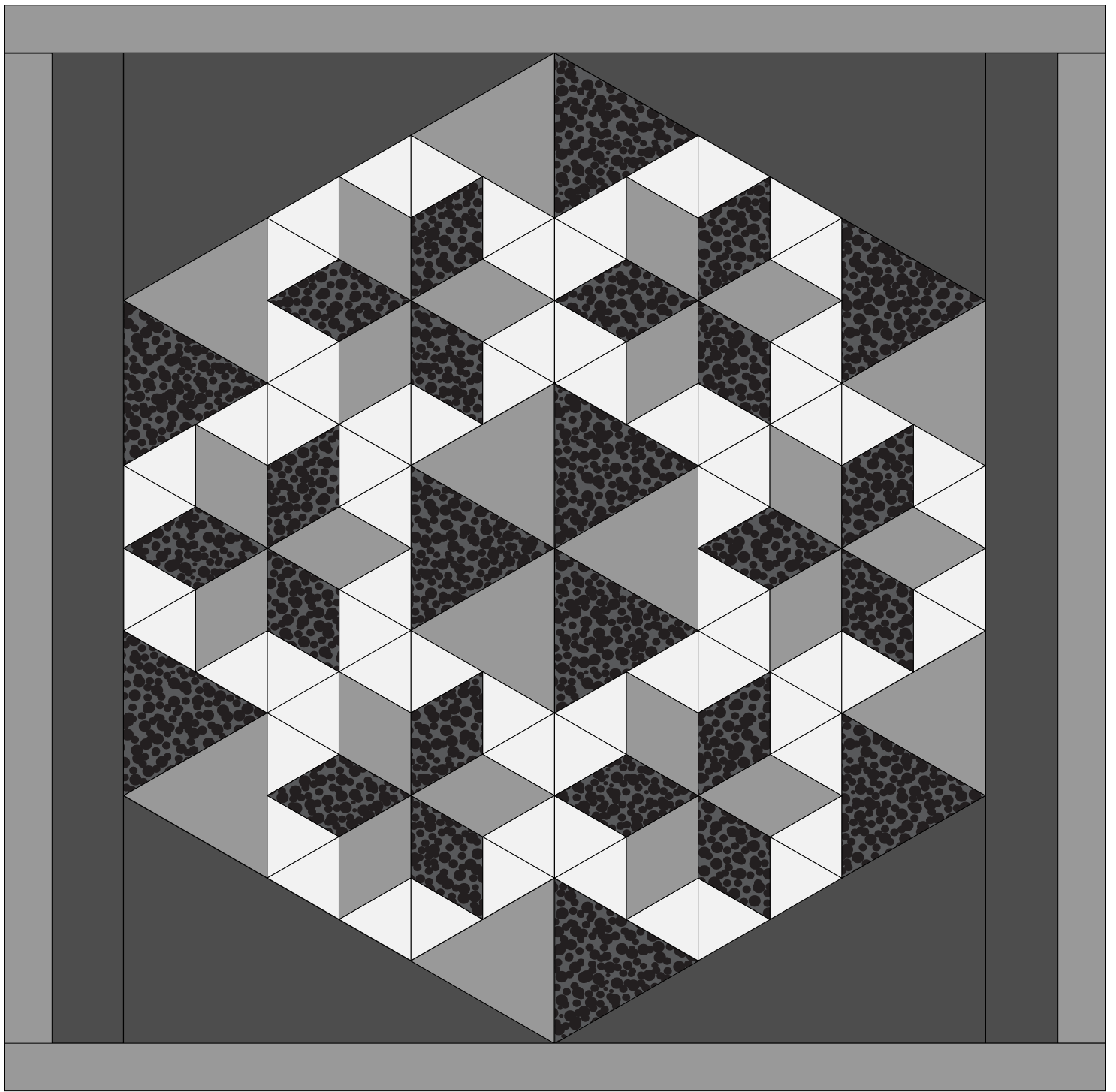

**Hextravaganza Layout**

We hope you have enjoyed making your own version of *Hextravaganza*. Consider sharing a photo of your project either on Instagram ([#Hextravaganza180](#)) or on our Gallery page!

For more unique tools and patterns by Deb Tucker & Studio 180 Design, visit your local quilt shop or check out our web site: [Studio180Design.net](#)

© 2020 Deb Tucker & Studio 180 Design, Ltd. All rights reserved. Printed in the USA.