

Rapid Fire Hunter's Star

Cutting Dimensions - Petite Star Ruler

Technique Developed by Deb Tucker
© Studio 180 Design, Ltd.



To make your first project, use the "Basic recipe" enclosed for a wall hanging sample (four by four blocks). Once you've worked through the process, use the chart below to help determine future project requirements.

Anatomy of a Hunter's Star Block

Each block contains the following pieces: two triangles, two trapezoids and four star points. By doing a little mathematics it is simple to calculate the number of strips you will need to cut and hence the amount of yardage you will need to buy. Below is a chart outlining the number of units possible from strips of fabric cut from standard 42" width.

Points to remember with the Rapid Fire technique:

- 1) All triangles are cut oversized and then trimmed down after the block is sewn.
- 2) The star points begin as long strips of fabric and not individual diamonds.
- 3) The trapezoids are the only shape that need to be cut to an exact shape and size.

As with most patchwork, careful measuring, cutting, pressing and sewing with an accurate $\frac{1}{4}$ " seam allowance give best results

✿ The Math - Example ✿

- Determine the number of blocks and the size of blocks
Example 6 blocks x 8 blocks (for a total of 48 blocks)
Using 8" blocks.
- Determine the number of pieces needed
Example 48 Light value triangles (1 per block)
48 Medium value triangles (1 per block)
48 Light value trapezoids (1 per block)
48 Medium value trapezoids (1 per block)
192 Star points/diamonds (4 diamonds x 48 blocks)
- Examine chart below.
- Determine the number of strips and units to cut
Example 5 strips 8" wide will yield 50 triangles
Need - 40" light value fabric for triangles
Need - 40" medium value fabric for triangles
10 Strips $1\frac{3}{4}$ " wide will yield 50 trapezoids
Need - $17\frac{1}{2}$ " light value fabric for triangles
Need - $17\frac{1}{2}$ " medium value fabric for triangles
16 Strips $2\frac{1}{4}$ " wide will yield 192 star points
Need - 36" for star points
- Add up the number of strips (number of inches) necessary to determine total number of yards for piecework.
- **Don't forget to add additional yardage for your borders and bindings.**

All strips should be cut across the Width of 100% cotton fabric.	Cut size of each strip x Width of Fabric (WoF)	Yield per Strip
5" Blocks - Triangle Strips Trapezoid Strips Star Point Strips	Cut 5" Cut $1\frac{3}{4}$ " Cut $2\frac{1}{4}$ "	8 Squares/ 16 half square triangles 13 Trapezoids using 5" cutting guides 12 Star Points/diamonds
6" Blocks - Triangle Strips Trapezoid Strips Star Point Strips	Cut 6" Cut $1\frac{3}{4}$ " Cut $2\frac{1}{4}$ "	7 Squares/ 10 half square triangles 9 Trapezoids using 6" cutting guides 12 Star Points/diamonds
7" Blocks - Triangle Strips Trapezoid Strips Star Point Strips	Cut 7" Cut $1\frac{3}{4}$ " Cut $2\frac{1}{4}$ "	6 Squares/ 8 half square triangles 7 Trapezoids using 7" cutting guides 12 Star Points/diamonds
8" Blocks - Triangle Strips Trapezoid Strips Star Point Strips	Cut 8" Cut $1\frac{3}{4}$ " Cut $2\frac{1}{4}$ "	5 Squares/ 10 half square triangles 5 Trapezoids using 8" cutting guides 12 Star Points/diamonds

Basic Recipe: Petite Wall Quilt

Using 6" Blocks and Petite Star Template

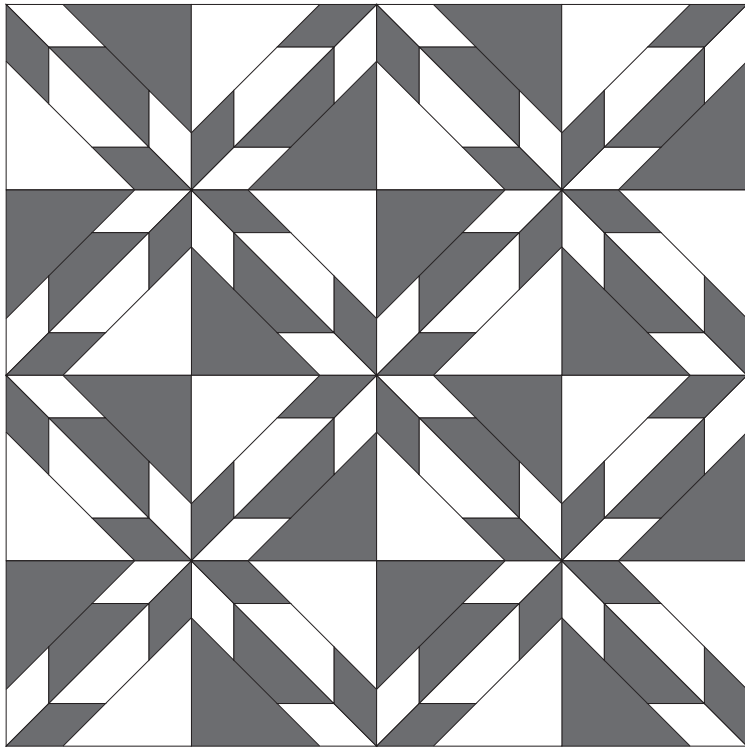

An Extra 1/2 to 3/4 yard or two or more fabrics will be needed to make borders and bindings

Two Color Quilt Project

Shown in Diagram: 24" x 24" Before Borders

From Dark Fabric(s) 3/4 Yard

Cut 2 strips 6" x WoF (Width of Fabric)
Cut into 8 squares 6" x 6"
Then cut into 16 half square triangles

Cut 2 strips 1 3/4" x WoF
Using Rapid Fire Petite Star template
Cut 16 trapezoids using the 6" guidelines

Cut 3 strips 2 1/4" WoF (for star points)

From Light Fabric(s) 3/4 Yard

Cut 2 strips 6" x WoF (Width of Fabric)
Cut into 8 squares 6" x 6"
Then cut into 16 half square triangles

Cut 2 strips 1 3/4" x WoF
Using Rapid Fire Petite Star template
Cut 16 trapezoids using the 6" guidelines

Cut 3 strips Cut 2 1/4" WoF (for star points)

NOTE

The cutting directions are for the INTERIOR PIECING ONLY.
Additional strips and fabric will be needed for the borders.

Three Color Quilt Project



From Dark Fabric(s) - for background piecing _____ 1/2 Yard

Cut 2 strips 6" x WoF and proceed as above
Cut 2 strips 1 3/4" x WoF and proceed as above

From Light Fabric(s) - for background piecing _____ 1/2 Yard

Cut 2 strips 6" x WoF and proceed as above
Cut 2 strips 1 3/4" x WoF and proceed as above

From Accent Fabric(s) - for stars/diamonds _____ 1/2 Yard

Cut 6 strips 2 1/4" x WoF

Four Color Quilt Project

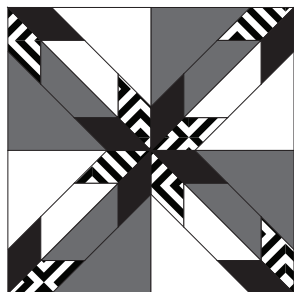

From Dark Fabric(s) - for background piecing _____ 1/2 Yard

Cut 2 strips 6" x WoF and proceed as above
Cut 2 strips 1 3/4" x WoF and proceed as above

From Light Fabric(s) - for background piecing _____ 1/2 Yard

Cut 2 strips 6" x WoF and proceed as above
Cut 2 strips 1 3/4" x WoF and proceed as above

From Accent Fabric #1 - for stars/diamonds _____ 1/4 Yard

Cut 3 strips 2 1/4" x WoF

From Accent Fabric #2 - for stars/diamonds _____ 1/4 Yard

Cut 3 strips 2 1/4" x WoF

Rapid Fire Hunter's Star General Directions

Technique Developed by Deb Tucker, Studio 180 Design, Ltd.

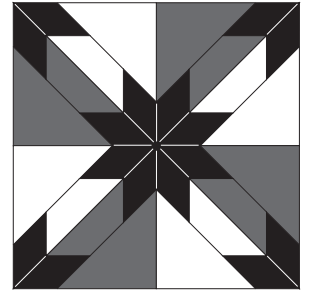

How to Cut the Trapezoid

To cut the trapezoid pieces, you will use the "Rapid Fire Hunter's Star" ruler and the appropriate size strip. If you are working with the "Petite Star" template, all of the strips for all of the trapezoids are cut to $1\frac{3}{4}$ " x WoF (Width of Fabric). If you are working with the "Large Star" template, all of the strips for all of the trapezoids are cut $2\frac{1}{4}$ " x WoF.

To cut the trapezoid shape examine the diagram shown here.

- Lay the strip horizontally on your cutting mat. It can be folded in half either right sides or wrong sides together. Be sure to cut from the open end toward the folded end of strip in order to be able to get the listed number of trapezoids/strip.
- If right handed, lay strip(s) with selvages on left and center fold on right. Make cuts from left to right.
- If left handed, lay strip(s) with selvages on the right and center fold on left. Make cuts from right to left.
- Rotate your template so that it is set "On Point" with the lines as shown in the diagram.
- Align the appropriate lines for the size template/block with which you will be working. (See NOTE)
- Cut on both sides of the ruler.
- Rotate the entire ruler and continue cutting additional trapezoids from the remainder of the strip as illustrated in the thumbnail sketch below.

NOTE
There is a **solid marked line** that should align with the bottom edge of your strip and there is an **upper dashed line** that should align with the top edge of the strip. **If both marked lines are not on the edges of the strip, something is wrong!!!** Check the size of the strip or make sure you do not have the "Star Point/Diamond" strip.

Guide Line Measurement	# of Trapezoids per WoF Strip
5" Line	13 per strip
6" Line	9 per strip
7" Line	7 per strip
8" Line	5 per strip

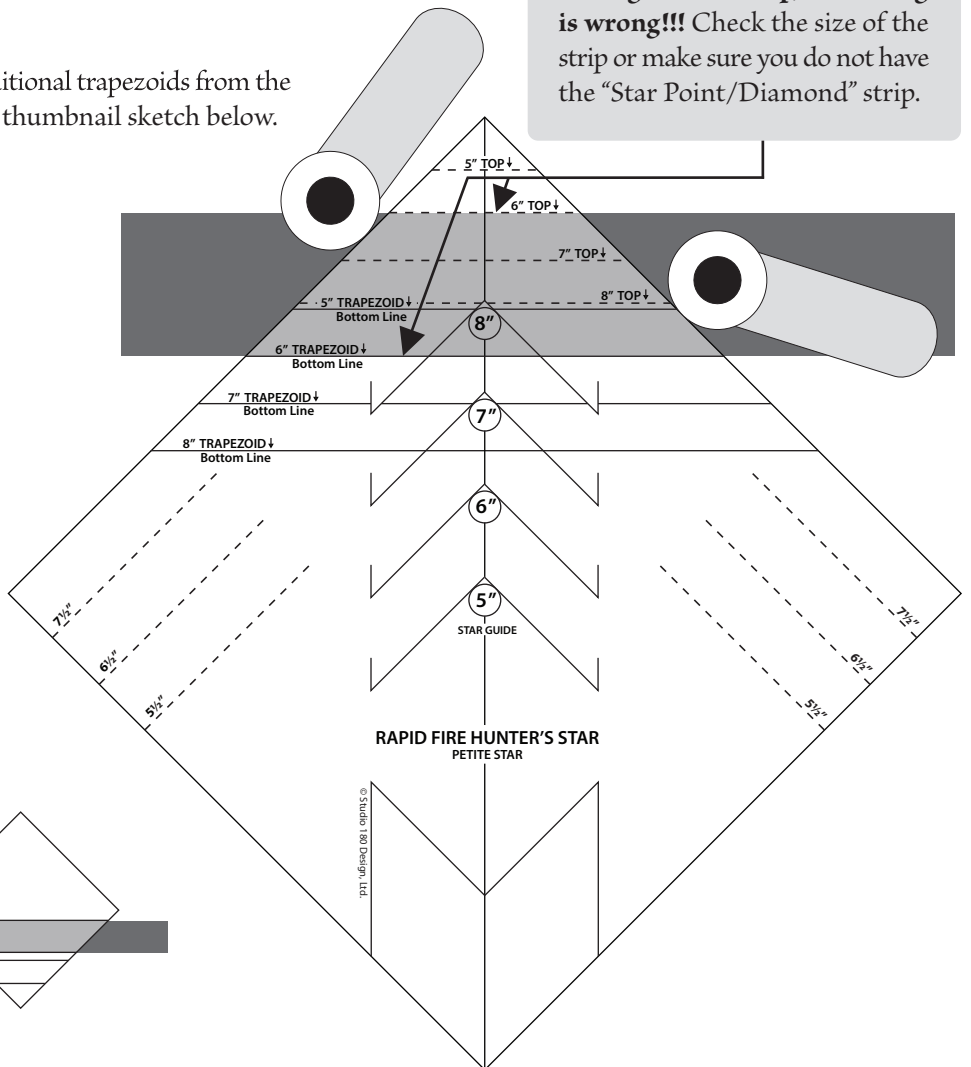

NOTE
It is important to focus on the correct size and line marking for your particular block. The Basic Recipe will use the 6" trapezoid lines.

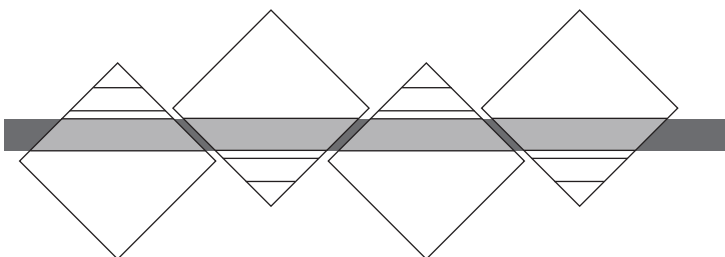

Piecing Instructions

The following directions are written in three color format. If using either a two color format or a four color format, please refer to the italicized notes in step 1, step 3, and step 6. Whenever possible I will try to note the procedures for the two color and four color options.

The directions will be shown for the construction of four blocks/one large star block (diagram shown at right). Generally you will need to continue a step until all units are processed. No specific numbers will be listed here as there are general directions for making many different size blocks and different size project. As stated earlier, it is advisable to work through the "basic recipe"/introductory project first to familiarize yourself with the steps and techniques presented. One time through will solidify the steps and allow for many different approaches to the Hunter's Star design.

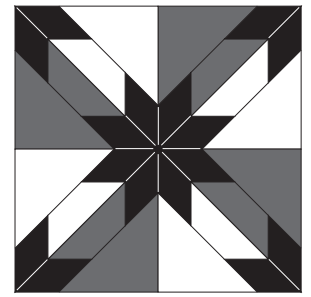

Four blocks sewn together make one large star block. Shown above in the three color option

Quilters should use good skills when cutting and pressing and always sew with an accurate 1/4" seam allowance.

Step 1 - Organize the pieces. You will need the precision cut trapezoids and the star point/diamond strips. Hold the triangle pieces until later.

- | | |
|-------------------------------------------------------------------------------------------------------------------------------------------------|-----------------------------------|
| <i>Petite Star - 2 1/4" strips</i> | <i>Large Star - 2 1/2" strips</i> |
| <i>Two Color Project - Diamond strips of both colors.</i> | |
| <i>Three Color Project - All diamond strips are the same color.</i> | |
| <i>Four Color Project - Two different color strips. For this first step, choose just one color strip and hold the second color until later.</i> | |

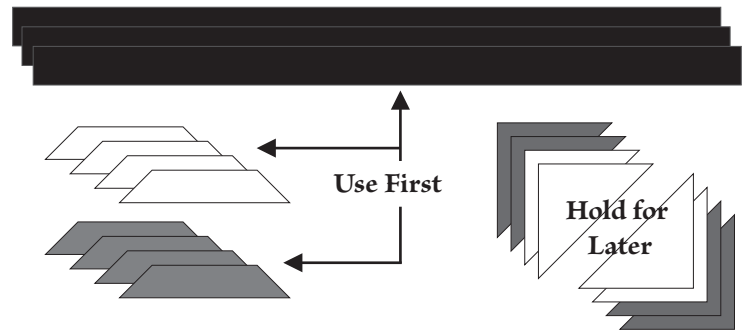

Step 2 - Position the trapezoids right sides together with the diamond strips. Align the pieces as illustrated. Be sure to start the lead trapezoid approximately 2 1/4" to 2 1/2" down from the top edge of the diamond strip. See illustration.

Points to Remember:

- Right sides together
- "Pointy" end of trapezoid first under the needle
- Cut edges carefully aligned

Step 3 - Stitch the trapezoids to the strip using an accurate 1/4" seam allowance and a chain piecing style of sewing. Be sure to leave approximately 1/4" of space between the trapezoids.

- Two Colors - stitch all color #1 trapezoids to color #2 strips, then stitch all color #2 trapezoids to color #1 strips.*
- Three Colors - stitch all trapezoids to the third color diamonds strips.*
- Four Colors - stitch all color #1 and color #2 trapezoids to just one color diamond strips. Hold the second diamond color strip until stitching at step 6.*

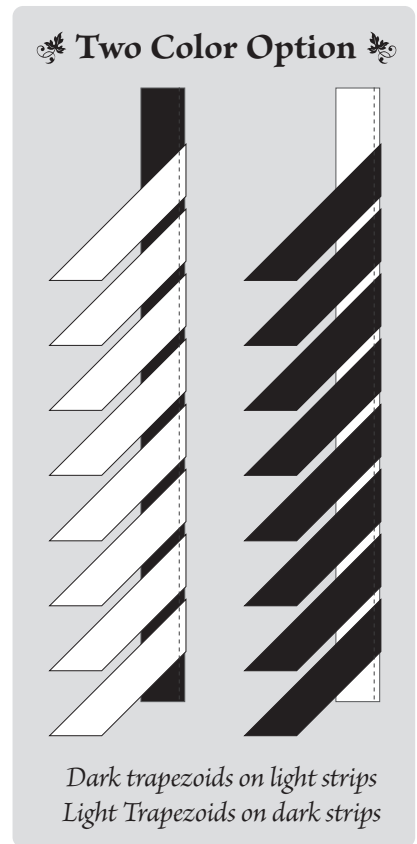
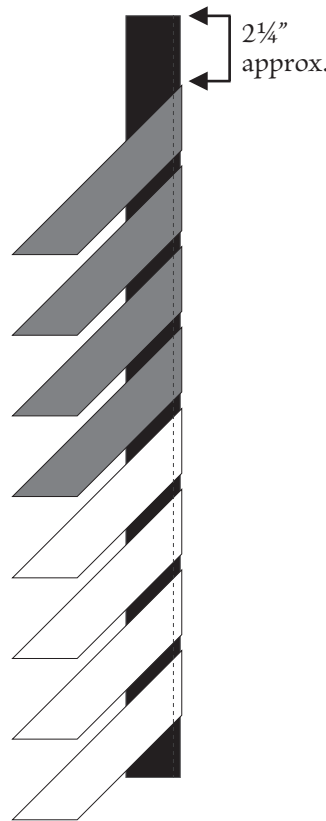

*Three and Four color options:
Both color trapezoids
on one color strips*

NOTE

Half Length Strips (21" approx.) are much easier to work with than whole length strips (42" approx.).

Petite Star should stitch 12 to 14 trapezoids on a whole strip, and 6 trapezoids per half strip.

Large Star should stitch 10 to 11 trapezoids on a whole strip, and 5 trapezoids per half strip.

Step 4 - Press. Lay the strip with the attached trapezoids on the ironing board. Strip on the bottom and trapezoids on top. Press flat to lock stitches. Carefully flip trapezoid back and press to the sewn seam as shown here.

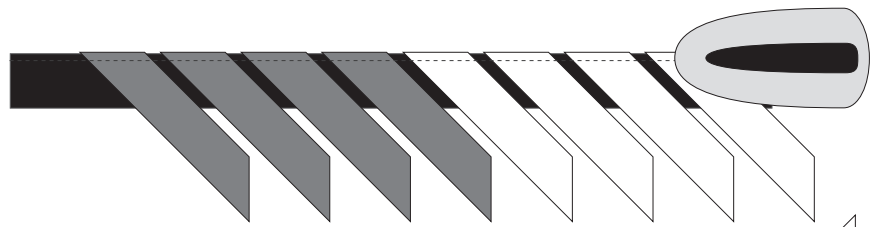

Step 5 - Trim. Move the entire strip to the cutting mat and position as illustrated. Note the different placement for “Righties” (right handed quilters - shown below right) and “Lefties” (left handed quilters - shown below left).

Step 4 - Pressing Diagram

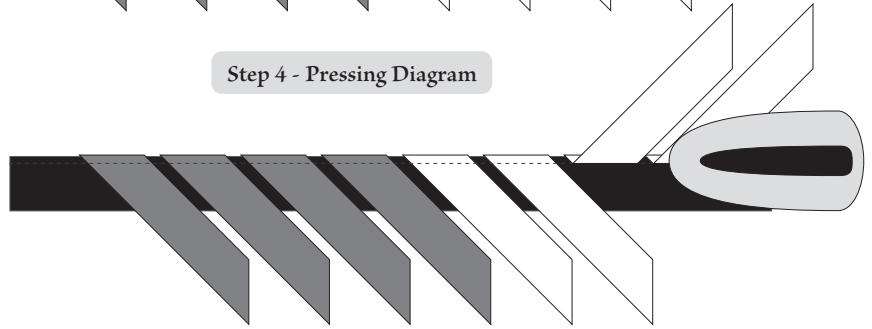

Position the center line of the Rapid Fire Hunter’s Star Ruler over the raw edge of the star point/diamond strip. Align the cutting edge of the ruler with the long edge of each trapezoid. Trim units apart (the cut should match the end of the trapezoid, and stay true to the 45° line).

Trim even with the long edge only. Do not trim even with the opposite edge at this time! Handle carefully.

Righties
 Step 5 - Right Hand Trimming Diagram
 Place strip vertically on your cutting mat and trim.

NOTE
 It is more important to **maintain the 45° angle** than to keep the edge of the ruler even with entire edge of the trapezoid. Simply make sure the cut edge of the diamond comes directly off the cut edge of the trapezoid. Any bowing will be corrected later.

Lefties
 Step 5 - Left Hand Trimming Diagram
 Place strip horizontally on your cutting mat and trim.

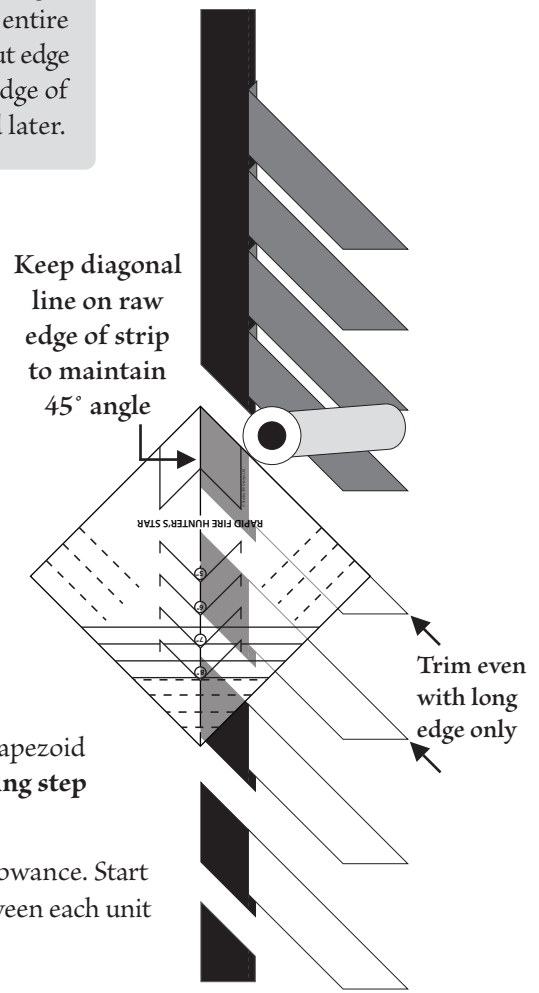
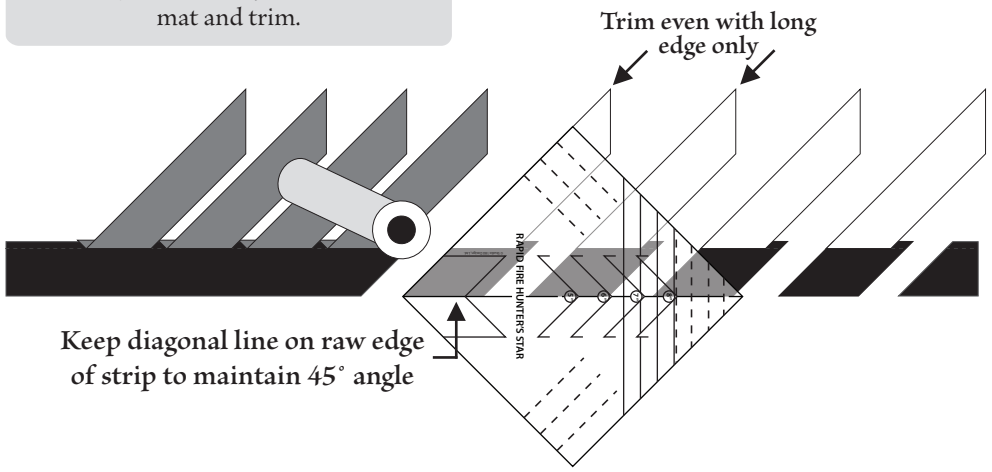

Step 6 - Stitch Again. Diagram located on next page. Stitch the other short end of the trapezoid unit to star point/diamond fabric strips. **Take note again that half strips for this sewing step are much easier than whole strips.**

Place the pieced units and strip right sides together. Stitch using an accurate 1/4” seam allowance. Start first trapezoid unit down approximately 1/2” from the end of the strip. Leave a 1/4” gap between each unit when stitching. Be sure to **leave 2 1/4” at end of strip.** This step is illustrated on the next page.

Petite Star units should be able to sew 6 units per half strip.
 Large Star units should be able to sew 5 units per half strip.

Step 6 - Stitching Diagram

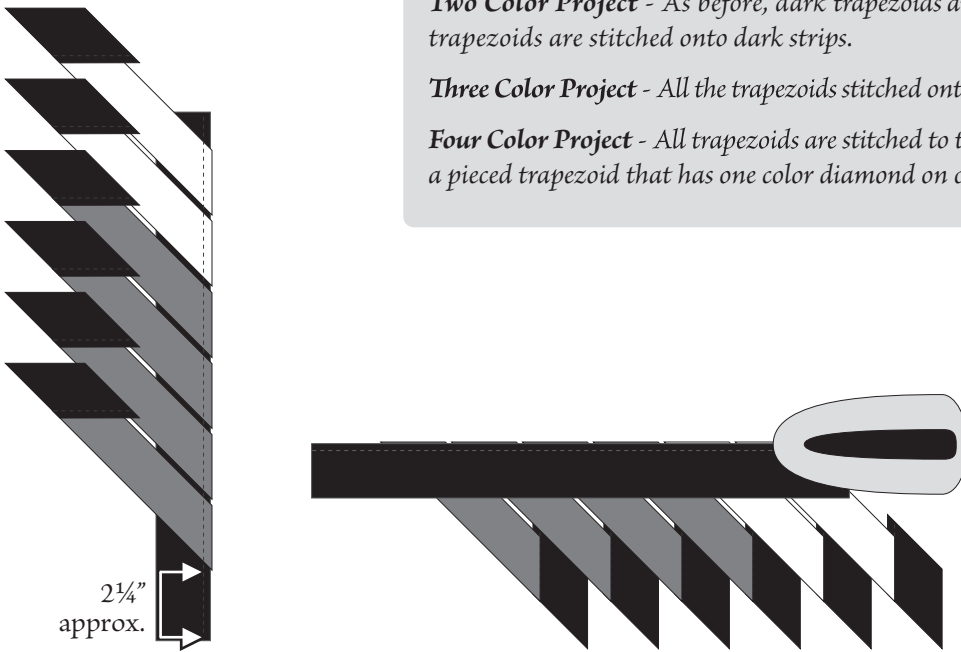

Project Options

Two Color Project - As before, dark trapezoids are stitched onto light strips and the light trapezoids are stitched onto dark strips.

Three Color Project - All the trapezoids stitched onto same color diamond strip.

Four Color Project - All trapezoids are stitched to the remaining color diamond strips. This results in a pieced trapezoid that has one color diamond on one side and a second color diamond on the other.

NOTE

This is the hardest part of the entire technique! Finger pressing first helps to make this step a bit easier.

Step 7 - Pressing Diagram

Press flat then press seams toward the star point/diamond strip.



Step 7 - Press. This step is a bit challenging, but it is worth doing correctly for proper nesting of seams in future steps.

Position entire piece on ironing board so that **trapezoids are on the bottom and star point/diamond strip is on top**. See illustration below. Press the seam flat first. Carefully flip **strip** back and press again so that the seam allowance will be going toward the strip. Be very careful to avoid pleats when pressing. Seams should be pressed toward the star point/diamond strip before proceeding.

Step 8 - Trim. After pressing, take entire piece to cutting mat. Place as illustrated for “Right Handed” trimming (shown in diagram below for right handed quilters), or for “Left Handed” trimming (shown in diagram on the next page for left handed quilters).

Righties

Step 8 - Right Handed Trimming Diagram

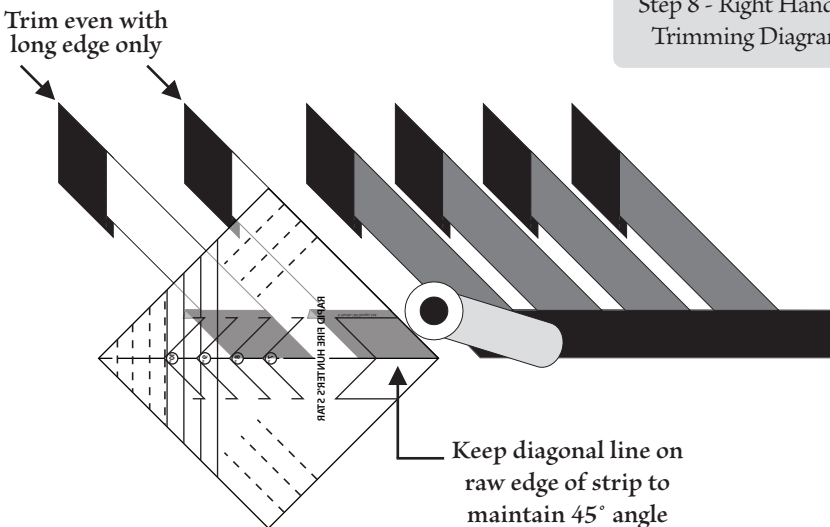

Righties Trimming Instructions. Lay strip horizontally on cutting mat as illustrated: right side up, with the star point/diamond strip closest to you, trapezoids angled up and left. Position the Rapid Fire Hunter’s Star ruler so the center diagonal line is aligned with the raw edge of the star point/diamond strip. Align the cutting edge of the ruler with the long edge of the trapezoid. Trim apart. As before, cut units following the **long edge of the trapezoid only**.

Step 8 continued - Lefties Trimming Instructions. Lay strip vertically on cutting mat as illustrated: right side up, star point/diamond strip on right, trapezoids angled to the left and down. Position the Rapid Fire Hunter's Star ruler so the center diagonal line is aligned with the raw edge of the star point/diamond strip. Align the cutting edge of the ruler with the long edge of the trapezoid. Trim apart. As before, cut units following the **long edge of the trapezoid only**.

Lefties
Step 8 - Left Handed Trimming Diagram

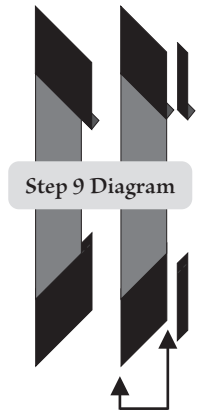
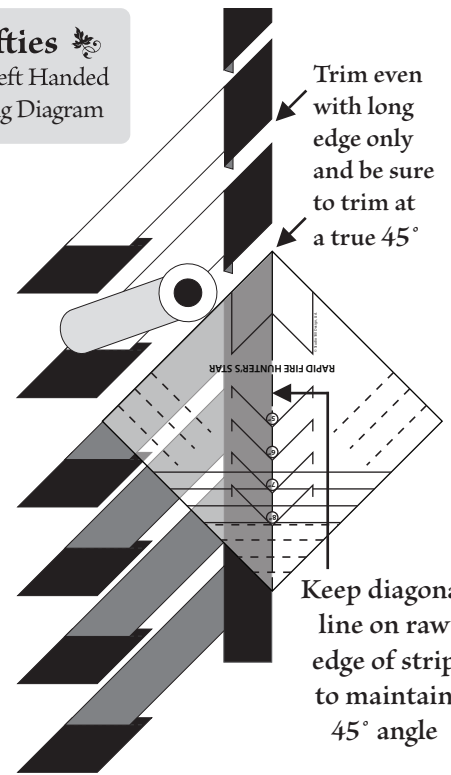

Step 9 Diagram

Step 9 - Trim Again. Make the final trim on the trapezoid units. Use a regular rotary cutting ruler for this job (3" x 18" or larger will do). If working with the Rapid Fire Petite Star ruler, trim units to measure 1 3/4". If working with the Rapid Fire Large Star ruler, trim units to measure 2 1/4".

Trim to 1 3/4" for Petite Star projects.
Trim to 2 1/4" for Large Star projects.

DEB'S HINT

Make a masking tape guide several layers deep and place it exactly at the 1 3/4" line (for Petite Star Projects) or 2 1/4" line (for Large Star Projects) of your ruler. When you bump this raised edge up against the previously trimmed edge it will help the trim down process go much more quickly.

Step 10 - Stitch. Sew the oversized triangle to trapezoid/diamond units. Use a triangle of the same fabric as trapezoid (this is the general rule, but variations here can result in some interesting designs). Place triangle and trapezoid units right sides together, positioning the triangle so it is in the center of the pieced trapezoid unit (an approximation will be fine). Sew an accurate 1/4" seam, chaining the pieces as you stitch them together. When finished, press the seams toward triangles.

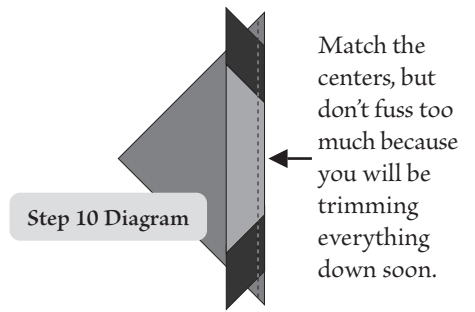

Step 11 - Press. Press seams flat first to lock the stitches and then press towards the triangle.

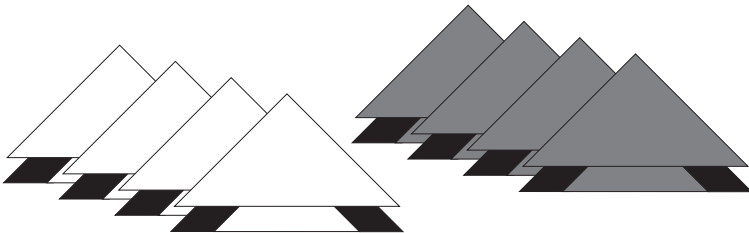

NOTE

Do not automatically sew the two triangles together yet! Some layouts require light triangles to be pieced with other light triangles and dark with dark. For this reason it is best to consider design choices prior to stitching the pieced triangle units together.

Step 12 - Play! Arrange the pieced triangle units into preferred design. This is the fun part where you get to play around with the different variations before stitching the triangle units together. Check out some of the thumbnail sketches below and at the top of the next page or visit my web site to see many additional variations:

www.studio180design.net

← Arrange 4 blocks x 4 blocks to make a wall quilt

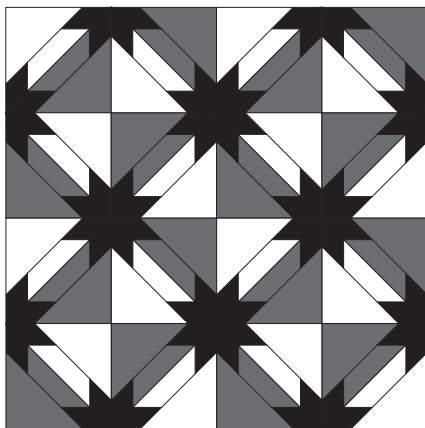

Arrange: 2 blocks x 8 blocks to make a table runner.

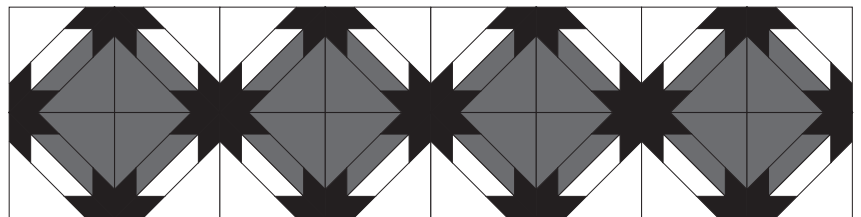

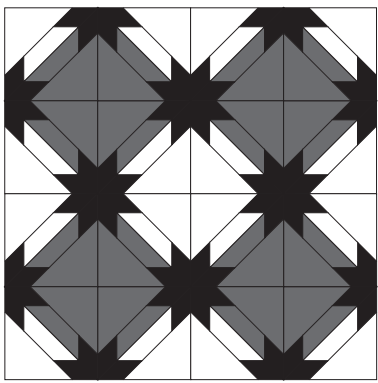

Square in a Square

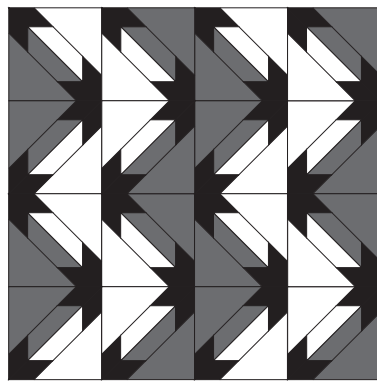

Streak of Lightning

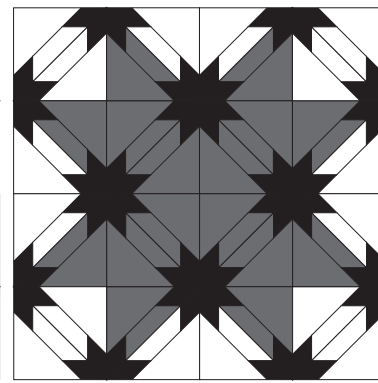

Background Star with Stars

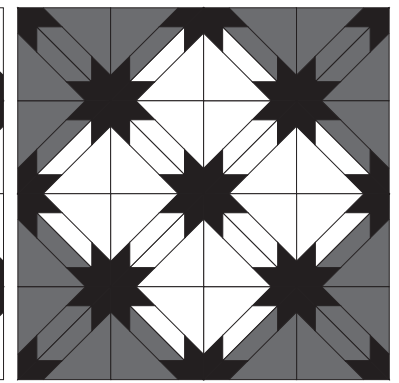

Barnraising/Medallion

Step 13 - Stitch. Once a design layout is chosen, analyze the types of blocks required and then stitch the pieced triangle units together along their diagonal edge. Place right sides together and **carefully align points of the trapezoids** (see circles on step 13 diagram). Don't be too concerned about aligning the outside edges of the large triangles as you will be trimming away the excess from those edges. Use an accurate $\frac{1}{4}$ " seam when stitching. Keep stitching straight and true all the way out to the ends of the points.

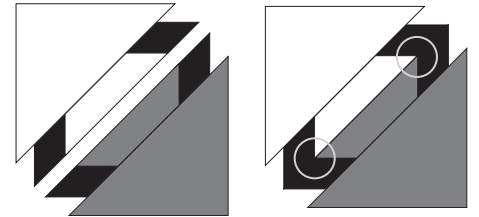

Step 14 - Press. Press all of the diagonal seams **open**.

Step 15 - Trim Pieced Squares to Exact Size. Carefully align the center line of the template with the center seam of the block. Also carefully align the diamonds on the template with the seam lines of the diamonds of the pieced block. Align opposite end of fabric trapezoid with appropriate size Star Guide on ruler (shown here with the large gray circles).

Step 13 Diagram
ALIGN THESE POINTS CAREFULLY!
 All seams should nest together for easy alignment. If this is not the case, carefully review pressing directions as Step 4 and at Step 7.

NOTE

The star guide lines are shown for both ends of the trapezoid and should align very closely with the sewn seams (see diagram). If lines and seams do not align exactly, **find the middle ground** then trim the two sides (one corner) and continue.

Step 16 - Rotate pieced square and carefully trim the other two sides and the opposite corner. Use the dashed lines along the side of the ruler to make each square the same size.

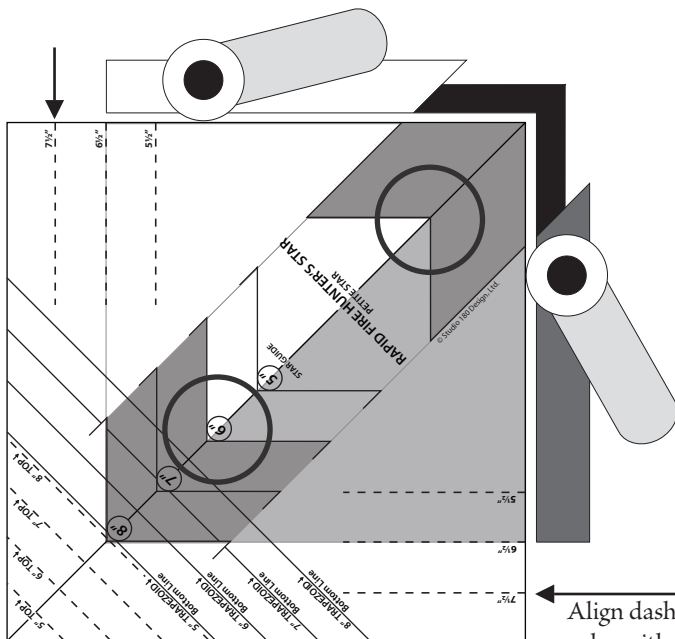

Align dashed lines of ruler with previously trimmed edges

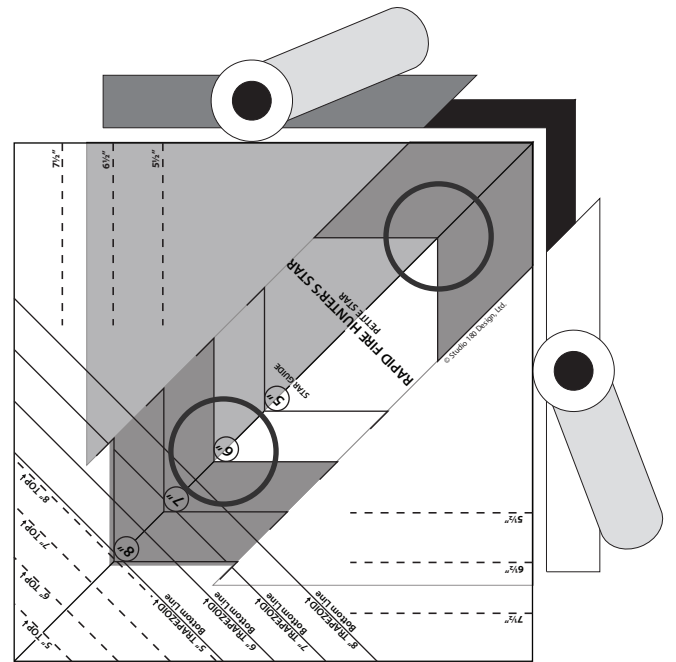

Step 17 - Assemble Your Design. Once all of the blocks are trimmed to size, they can be assembled into your chosen design. When sewing your blocks together, I generally **press all seams open** to distribute the bulk of the 8 star points evenly.

Step 18 - Border, Baste, Quilt and Bind to Finish. Add borders to suit your design. Finish quilt top using your preferred techniques.

For project specific patterns and more variations visit our web site at www.studio180design.net