

Dove in the Window Bed Runner

A Marie Bostwick & Studio 180 Design Collaboration



Dove in the Window

Companion Pattern
for the Tucker Trimmer® I tool

Quilt Designed by Deb Tucker, Studio 180 Design

Required Tools: [Tucker Trimmer® I](#)

Project Size: 34" x 95"

Marie and I have collaborated on quilt projects for many years. When we do so, there is usually a good deal of discussion about the story line, the characters, possible quilt designs, and difficulty level for actual quilt makers. Generally, the free project is a simpler version of a more difficult design that becomes a published pattern for my company, Studio 180 Design.

When discussing her novel, *Hope on the Inside*, we determined that a block titled "Dove in the Window" would be a perfect design starting point. But like so many of my designs, I like to put a bit of a twist on the traditional. I decided to nest a small Dove in the Window block inside a large Dove in the Window block, giving it a unique design not found in any block encyclopedia book currently in print.



The block size is large at 19½" finished, which by itself could make a nice wall quilt, but I decided to construct something I've been wanting for my bed - a "Bed Runner". Below, you'll find our instructions for making the 34" x 95" project. It has three of my double Dove in the Window blocks, set on point with simple sashing in between. It is constructed with my second signature fabric collection with Island Batik titled "Steam Engine," which Marie did a fantastic job of describing in her book. You can, of course, change the colors to coordinate with your own decorating style, but if you like what you see, the fabric will be in quilt shops late summer or early fall 2019.

I hope you'll enjoy making this for your bed and would love to see a photo when you are finished. You can share a photo of your project either on Instagram ([#DoveintheWindowBedRunnerPattern180](#)) or on our Gallery page at [Studio180Design.net](#).

Fabric Requirements

Based on 40" of usable fabric with few cutting errors.

Fabric	Swatch	Island Batik SKU #	Yardage
Blue		111917515	⅝ yard
Purple		111915451	⅝ yard
Background		White	¾ yard
Dark Setting Triangles		111915561, 111918350, 111917455, 111916560, 111921832, 111918565	6 fat quarters

Fabric	Swatch	Island Batik SKU #	Yardage
Light Purple		111923420	7/8 yard
Dark & Binding		BE24-D2	5/8 yard
Backing		Silverado	3 yards

It is recommended you read through the instructions to familiarize yourself with the steps before you begin, and, of course, that you use your best skills when cutting, sewing, and pressing.

We will start with a summary of the units you will need to create for this quilt.

Unit Summary

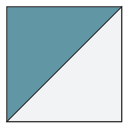

Blue Half Square Triangle (Small)
 1½" x 1½" finished (2" x 2" cut size)
 Make 24
Blue & Background

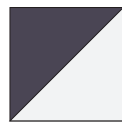

Purple Half Square Triangle (Small)
 1½" x 1½" finished (2" x 2" cut size)
 Make 24
Purple & Background

Blue Half Square Triangle (Large)
 3" x 3" finished (3½" x 3½" cut size)
 Make 24
Blue & Background

Purple Half Square Triangle (Large)
 3" x 3" finished (3½" x 3½" cut size)
 Make 24
Purple & Background

Cutting Instructions

Note: wof stands for width of fabric.

Fabric	Block	Cutting
Blue	Large Dove	Cut 2 strips 4" x wof; sub-cut into 12 squares 4" x 4".
		Cut 1 strip 3½" x wof; sub-cut into 12 squares 3½" x 3½".
	Small Dove	Cut 1 strip 2½" x wof; sub-cut into 12 squares 2½" x 2½".
		Cut 1 strip 2" x wof; sub-cut into 12 squares 2" x 2". (Use the remainder of the strip to cut the remaining 2" x 5" rectangles.)
Large Dove	Cut 1 strip 2" x wof; sub-cut into 12 rectangles 2" x 5".	
Purple	Large Dove	Cut 2 strips 4" x wof; sub-cut into 12 squares 4" x 4".
		Cut 1 strip 3½" x wof; sub-cut into 12 squares 3½" x 3½".
	Small Dove	Cut 1 strip 2½" x wof; sub-cut into 12 squares 2½" x 2½".
		Cut 1 strip 2" x wof; sub-cut into 12 squares 2" x 2". (Use the remainder of the strip to cut the remaining 2" x 5" rectangles.)
Large Dove	Cut 1 strip 2" x wof; sub-cut into 12 rectangles 2" x 5".	

Fabric	Block	Cutting
Background	Small Dove	Cut 2 strips 2½" x wof; sub-cut into 24 squares 2½" x 2½".
	Large Dove	Cut 3 strips 4" x wof; sub-cut into 24 squares 4" x 4".
	Block Sashing	Cut 2 strips 2" x wof; sub-cut into 12 rectangles 2" x 9½". Four rectangles per block.
6 Dark Fabrics	Setting Triangles	Cut 6 squares 15" x 15", sub-cut on the diagonals for a total of 12 half square triangles. (Slightly oversized)
Light Purple	Sashing	Cut 1 strip 28" x wof; sub-cut into 10 rectangles 3½" x 28".
Navy	Quilt Cornerstones	Cut 1 strip 3½" x wof; sub-cut into 8 squares 3½" x 3½".
	Block Cornerstones	From the remainder of the 3½" strip, cut 3 squares 2" x 2".
	Binding	Cut 2¼" strips by preferred method and piece to make 278" of binding.

Piecing Instructions

Note: Refer to the instructions that came with your **Tucker Trimmer® I** tool, or watch the instructional videos at Studio180Design.net for additional information, including left-handed cutting!

Dove in the Window

The blocks for the bed runner are made with opposite quarter block sections. You will need 6 quarters that have purple large doves and blue small doves, and 6 quarters that have blue large doves and purple small doves. Listed below are the squares that need to be grouped for creating the blocks.

Small Dove Group - Make 6 blue and 6 purple groups

Color Fabric - One square 3½" x 3½", two squares 2½" x 2½", and two squares 2" x 2"

Background Fabric - Two squares 2½" x 2½"

Large Dove Group - Make 6 blue and 6 purple groups

Color Fabric - Two squares 4" x 4", one square 3½" x 3½", and two rectangles 2" x 5"

Background Fabric - Two squares 4" x 4"

Small Dove Section

Step 1 – Organize and Mark. To create your small dove blocks, start with one 3½" square, two 2" squares, and two 2½" squares of the blue, and two 2½" squares of background fabric. Pair a blue 2½" square right sides together with a background 2½" square. Mark two stitching lines ¼" on either side of a center diagonal line. I use my **Quilter's Magic Wand™** for this task. Do this for both small squares.

Step 2 - Stitch on the lines, then cut down the middle. Press seams open.

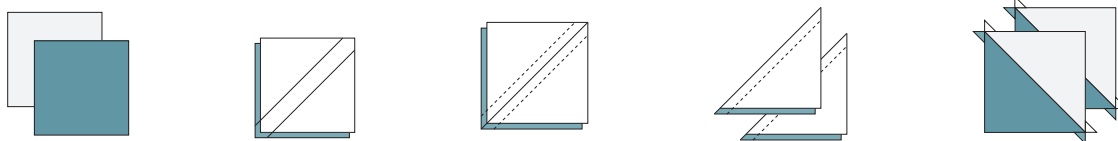

Steps 1 & 2 - Organize, Mark, Stitch, and Press

Step 3 - Trim the units to 2" using the Tucker Trimmer® I as shown. Align the 2" sizing diagonal with the seam and trim the first two sides.

Step 4 - Rotate the unit and line up the Tucker Trimmer® I again. This time be sure to position the sizing diagonal and the 2" cleanup lines. Trim the two remaining sides to create a precise, square unit. You will need 4 units.

Step 5 - Lay out the four 2" half square triangles, one 3½" square, and one 2" square as shown. Stitch the units and squares together as shown and press the seams open. Keep the last 2" square of this color grouped with it for later.

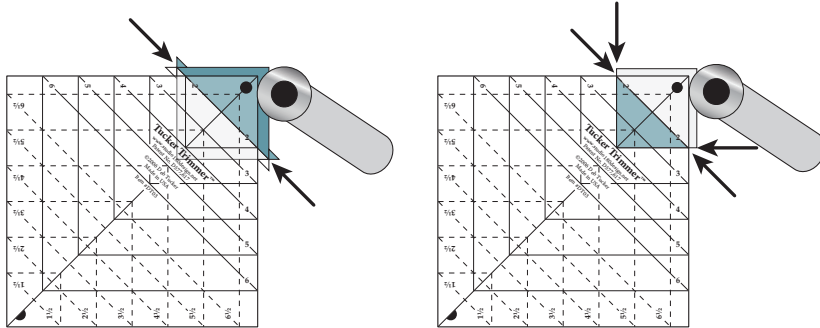

Steps 3 & 4 - Trim, Rotate, and Trim Again

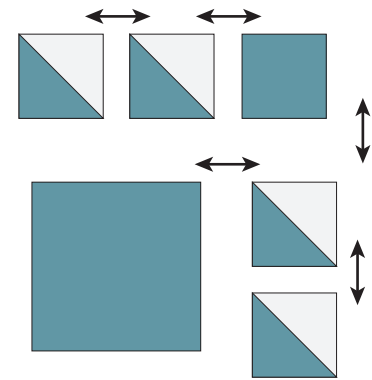

Step 5 - Lay out, Stitch, and Press

Step 6 - Repeat steps 1-5 to make a total of 6 blue small doves, and 6 purple small doves.

Large Dove Sections

Step 7 - Organize and Mark. To Create your large dove blocks, start with two 4" squares, one 3½" square, and two 2" x 5" rectangles of the purple, and two 4" squares of background fabric. Pair a purple 4" square right sides together with a background 4" square. Mark two stitching lines ¼" on either side of a center diagonal line. I use my Quilter's Magic Wand™ for this task. Do this for both squares.

Step 8 - Stitch on the lines, then cut down the middle. Press seams open.

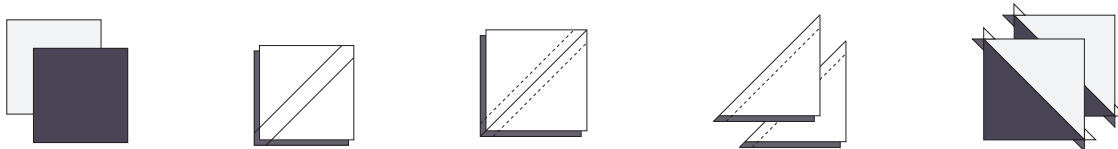

Steps 7 & 8 - Organize, Mark, Stitch, and Press

Step 9 - Trim the units to 3½" using the Tucker Trimmer® I as shown. Align the 3½" sizing diagonal with the seam and trim the first two sides.

Step 10 - Rotate the unit and line up the Tucker Trimmer® I again. This time be sure to position the sizing diagonal and the 3½" cleanup lines. Trim the two remaining sides to create a precise, square unit. You will need 4 units.

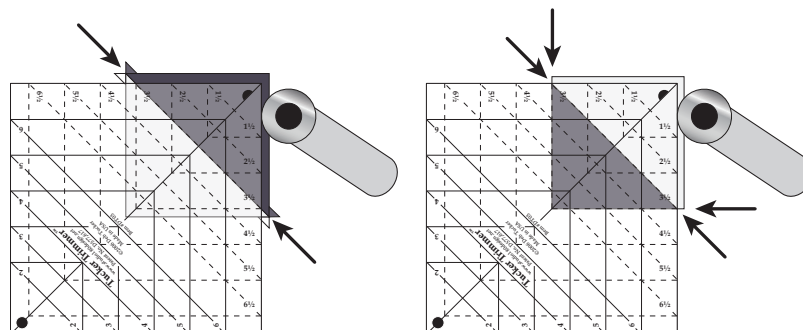

Steps 9 & 10 - Trim, Rotate, and Trim Again

Step 11 - Lay out a blue small dove set (small dove and one 2" square) with a purple large dove set (four 3½" half square triangles, one 3 ½" square, and two 2" x 5" rectangles) as shown.

Step 12 - Stitch the units together as shown and press the seams open.

Step 13 - Repeat steps 7 - 12 for all 6 purple large dove sets and 6 blue small dove sets to yield 6 quarter blocks. Repeat steps 7 - 12 with 6 blue large dove sets and 6 purple small dove sets to yield 6 quarter blocks.

Step 14 - Assemble into blocks. Lay out 2 quarter blocks of each kind, four 2" x 9½" background rectangles and one 2" navy square as illustrated. Repeat with the remaining quarter blocks to create three Dove in the Window blocks.

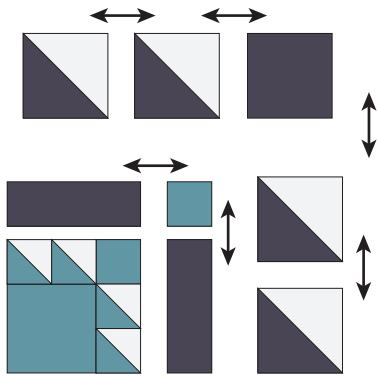

Steps 11 & 12 - Lay out, Stitch, and Press

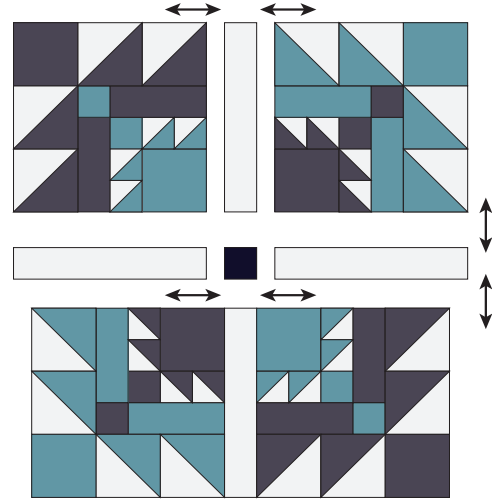

Step 14 - Lay out, Stitch, and Press

Step 15 - Lay out the three Dove in the Window blocks and 12 dark setting triangles as shown in the diagram. Arrange your setting triangles so that you have the colors balanced.

Step 16 - Stitch the slightly oversized half square triangles to the blocks. Align the raw edges, match the centers and sew with right sides together. Press seams toward the triangle. Position, stitch and press a second triangle to the opposite side.

Step 17 - Position, stitch, and press two more triangles to the remaining two sides.

Step 18 - Square up the block so that the seam intersections are ¼" away from the edges. The block should measure 28" x 28"

Step 19 - Lay out the three blocks with the sashing strips and navy cornerstones.

Step 20 - Stitch the sashing, blocks and cornerstones together into rows. Press the seams toward the sashing strips.

Step 21 - Stitch the rows together to create your Bed Runner.

Step 22 - Finish with Batting, Backing, Quilting, and Binding! Layer quilt top with batting and backing. Baste and quilt. Bind and Enjoy!

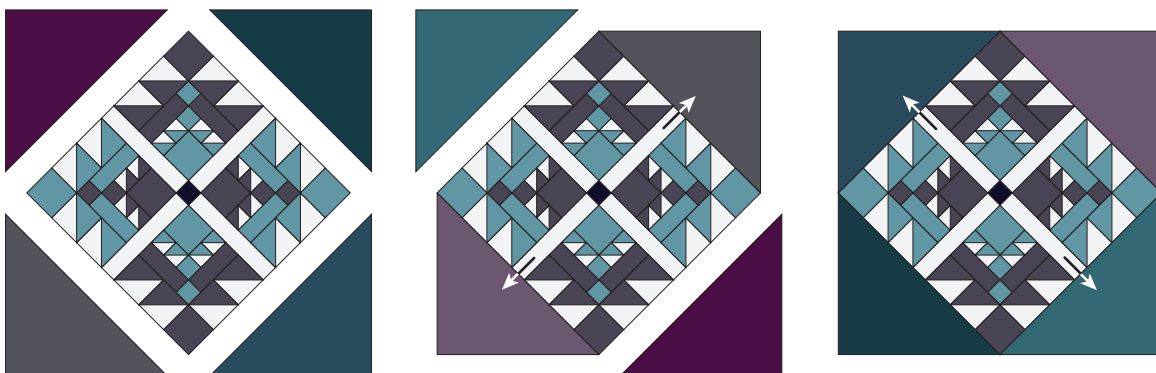

Steps 15 to 17 - Lay out, Stitch, Press, Stitch, and Press Again

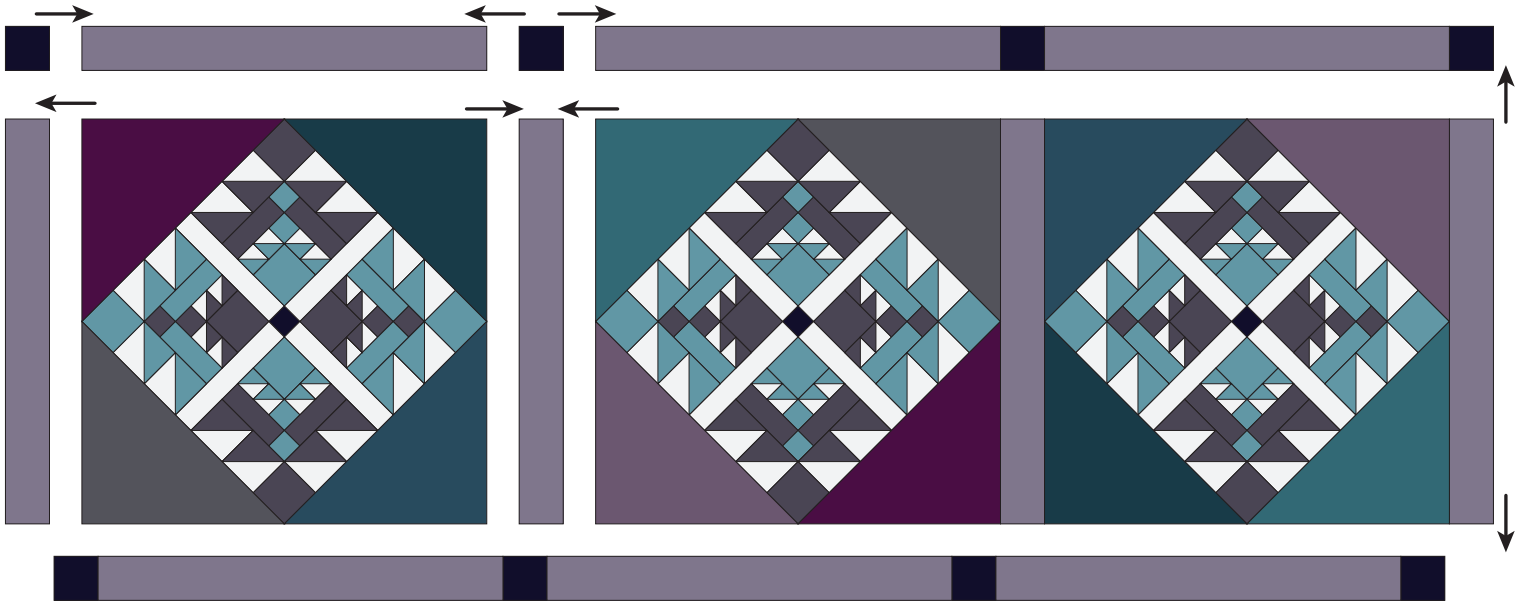

Project Layout Diagram

© 2019 Deb Tucker & Studio 180 Design, Ltd.

All rights reserved. No part of this pattern may be photocopied or reproduced in any form without prior written consent from Studio 180 Design, Ltd.

Studio180Design.net

We hope you have enjoyed making your own version of *Dove in the Window Bed Runner*. If you would like to create a larger, bed size project, look for our *Doves of Hope* pattern at your local quilt shop or on our website. We hope you consider sharing a photo of your project either on Instagram ([#DoveintheWindowBedRunnerPattern180](https://www.instagram.com/Studio180Design)) or on our Gallery page! To see other tools and patterns designed by the Studio 180 Design team, please visit our website:

Studio180Design.net