

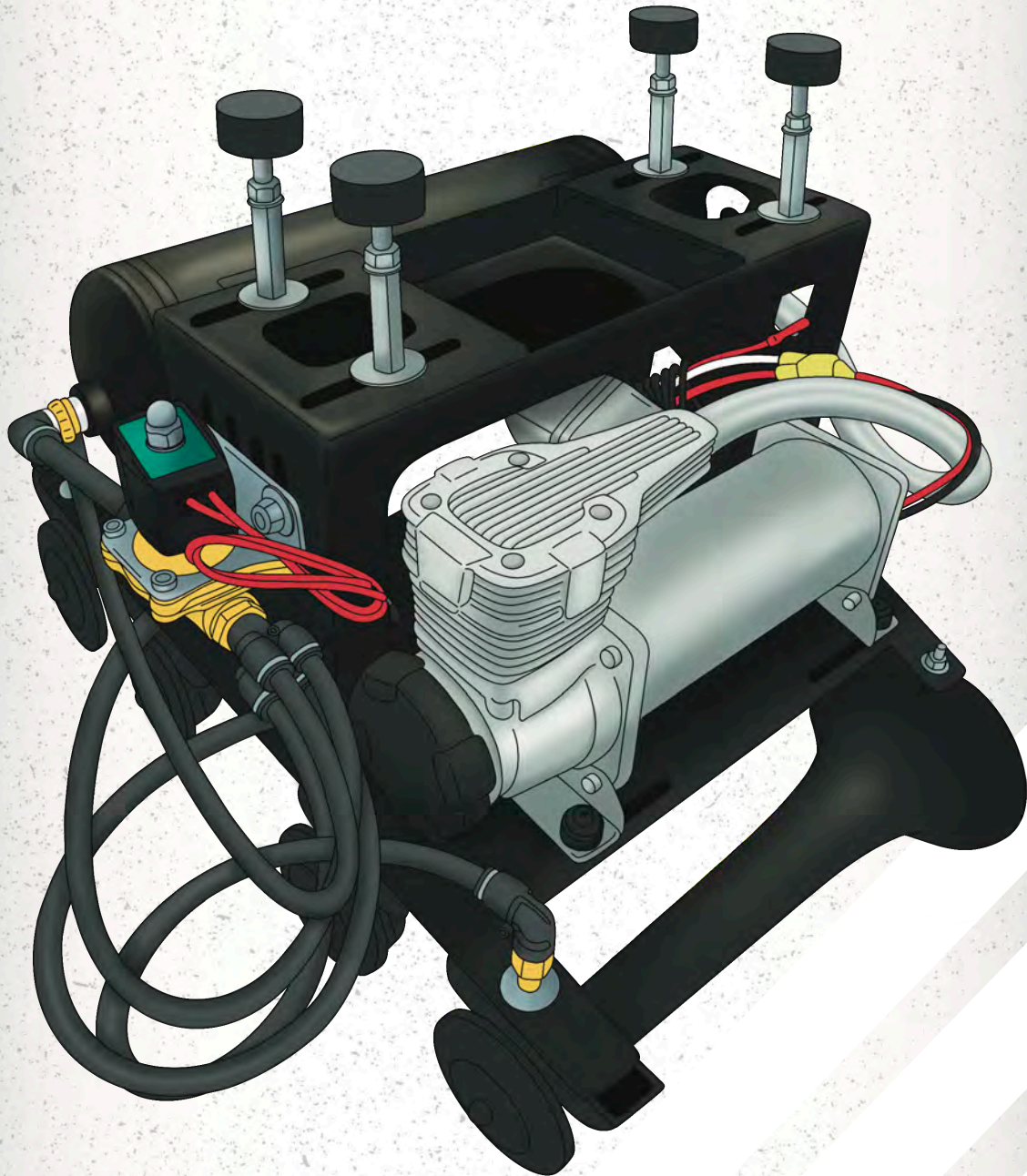

SINGLE TANK SPARE TIRE DELETE

INSTALLATION GUIDE



@hornblasters



*Failure to read these instructions
can result in an incorrect installation.*

COMPONENT LIST

⚠ NOTE: Some kits include parts specific to that kit, these are noted next to that part.

FITTINGS

| DESCRIPTION | QTY |
|--|--------|
| 1/2" M NPT to 1/2" Push to Connect Elbow |1 |
| 1/2" M NPT to x4 5/16" Push to Connect Banjo |1 |
| 1/2" M NPT to 1/2" Push to Connect Straight |1 |
| 1/8" F NPT to 5/16" Push to Connect Elbow |4 |
| 1/4" M NPT Drain Cock |1 |
| 1/4" M NPT 175 PSI Safety Blow-Off Valve |1 |
| 1/4" M NPT Brass Plug |1 |
| 1/4" M NPT Brass Run Tee |1 |
| 1/2" M NPT to 1/4" F NPT Brass Reducer |1 |
| 1/4" M NPT to 1/8" F NPT Brass Reducer |1 |

ELECTRICAL

| DESCRIPTION | QTY |
|--|--------|
| Train Horn / HornAir Wiring Kit |1 |
| 17' Roll of Blue 18 Gauge Wire |1 |
| 20' Roll of Grey 18 Gauge Wire |1 |
| 20' Roll of Red 10 Gauge Wire |1 |
| 110/150 PSI Pressure Switch w/ Built-In 40 Amp Relay |1 |

GAUGE

| DESCRIPTION | QTY |
|--|--------|
| HornBlasters 1/4" M NPT 250 PSI Air Pressure Gauge |1 |

HARDWARE

| DESCRIPTION | QTY |
|--|---------|
| Flat Washer 5/16" |10 |
| Hex Bolt, 5/16"-18 x 3/4" |10 |
| Split Lock Washer, 5/16" |8 |
| Fender Washer 5/16" |8 |
| Nylon Lock Nut, 5/16-18 |6 |
| Hex Nut Zinc 5/16" - 18 |4 |
| Hex Coupling Nut, 5/16"-18 |4 |
| STDK Rubber Isolator 5/16"-18 x 1 3/8" |4 |

COMPRESSOR

| DESCRIPTION | QTY |
|--|--------|
| Viair 380C Pewter Air Compressor <small>(Only for Conductor's Special 232)</small> |1 |
| Viair 400C Chrome Air Compressor <small>(Only for Conductor's Special 240)</small> |1 |
| Viair 444C Stealth Black Air Compressor <small>(Only for Conductor's Special 244K)</small> |1 |

TANK

| DESCRIPTION | QTY |
|---------------------------------------|--------|
| HornBlasters 2-Gallon 6 Port Air Tank |1 |

⚠ NOTE: Some kits include parts specific to that kit, these are noted next to that part.



Step 1.) HORN INSTALLATION

Mount the four black Shocker bells in the direction as seen in the photo to the left. Each small nut located at the opening of the bell can be tightened down with a 3/8" socket, and the rear nut with a 1/2" wrench.

Step 2.) TANK FITTINGS

Assemble the two gallon tank as seen below. Make sure to use the supplied teflon tape on all fittings that don't already have a pre-applied PTFE paste. Follow diagram 6.1 for models with the 485C compressor, follow diagram 6.2 for models with the 380C, 400C, & 444C compressors.

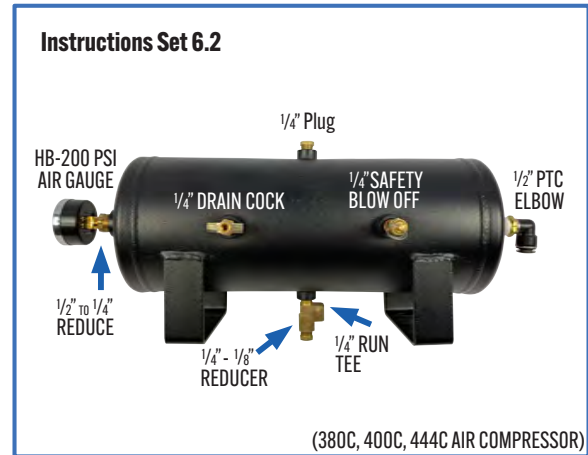
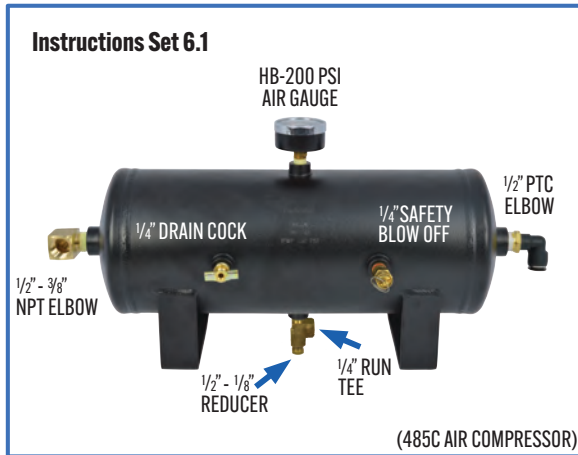

Step 3.) TANK MOUNTING

- 1 Using the supplied tank mounting hardware, mount the two gallon tank with the drain port facing down towards the horns.
- 2 The tank is mounted on the side of the bracket with the longest Shocker bell.



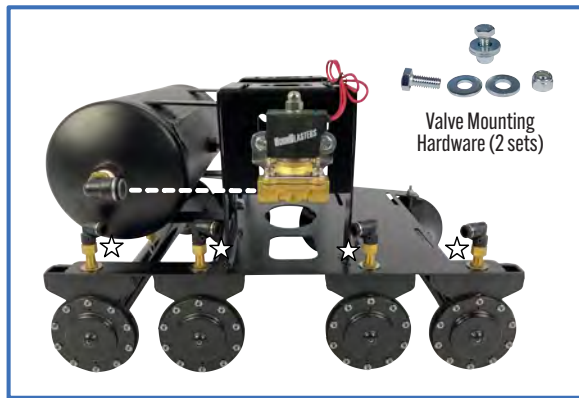





Step 4.) VALVE AND HORN FITTINGS

Mount the valve on the bracket using the supplied hardware and level with the air outlet on the tank. The tank kit includes 4 x 1/8" female to 5/16" PTC elbow fittings, labeled with a  on the diagram. Screw one fitting onto each of the air inlets of the bells that are protruding through the bracket.

 **NOTE:** These elbows do not need to be installed with teflon.

Step 5.) VALVE PLUMBING

- 1.) Cut one piece of 1/2" air line (the thicker of the two air lines) at a length of 5 1/4" using the supplied air line cutter.
- 2.) Cut pieces 2, 3, 4 and 5 out of the skinnier 5/16" air line at all equal lengths of 18"
- 3.) The 1/2" air line goes in between inlet fittings  and  (labeled in the diagram below).
- 4.) Cut pieces 2, 3, 4 and 5: Run from the 4-way tee off the valve to each individual elbow on the horns, labeled with a  on the diagram below.

 **NOTE:** Very minor adjustments may need to be made to the air lines for best fitment.

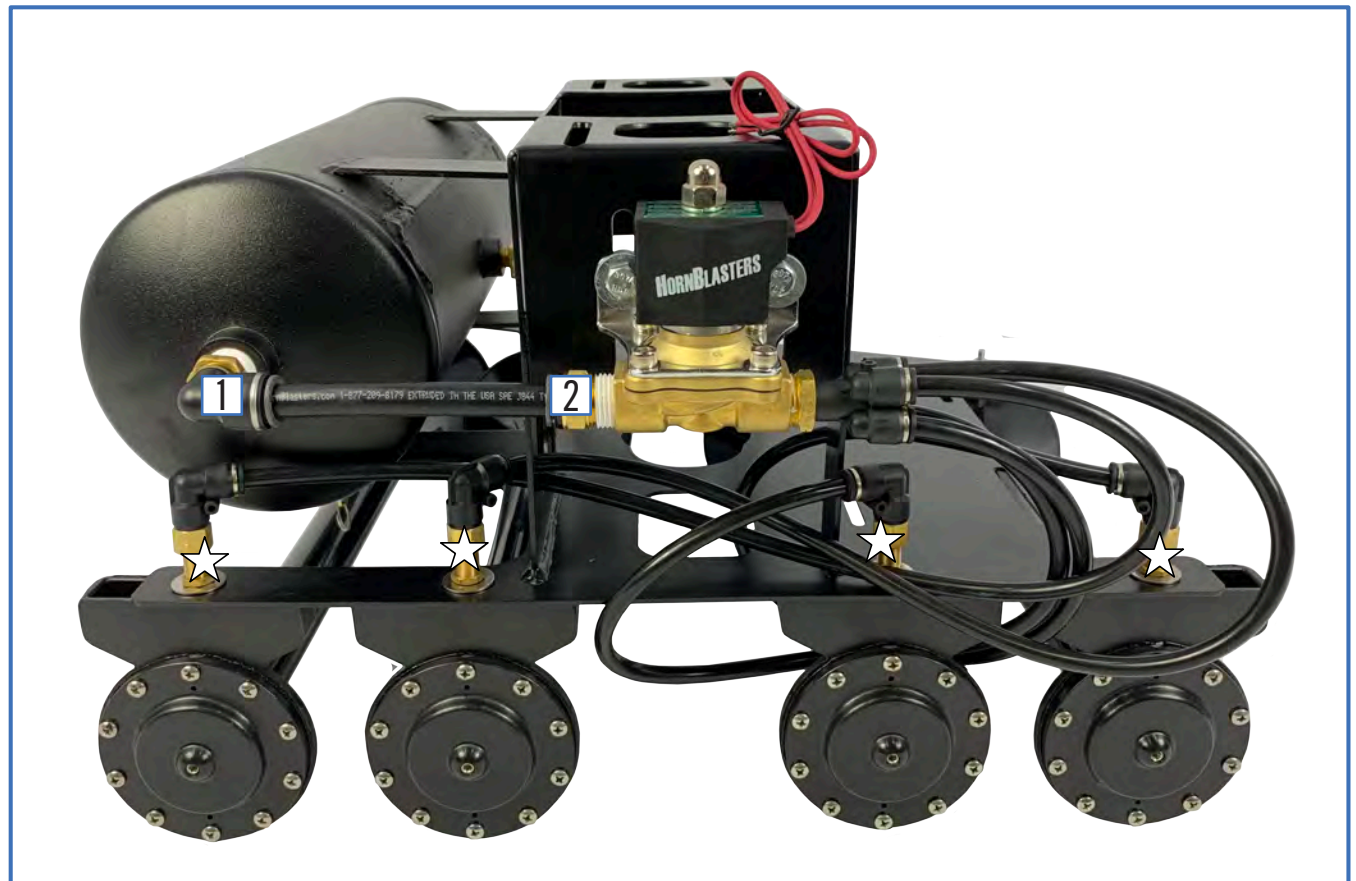

⚠ NOTE: Use Step 6.1 only with kit #HK-S4-2485

Step 6.1 COMPRESSOR & PRESSURE SWITCH MOUNTING 485C SERIES COMPRESSOR ONLY

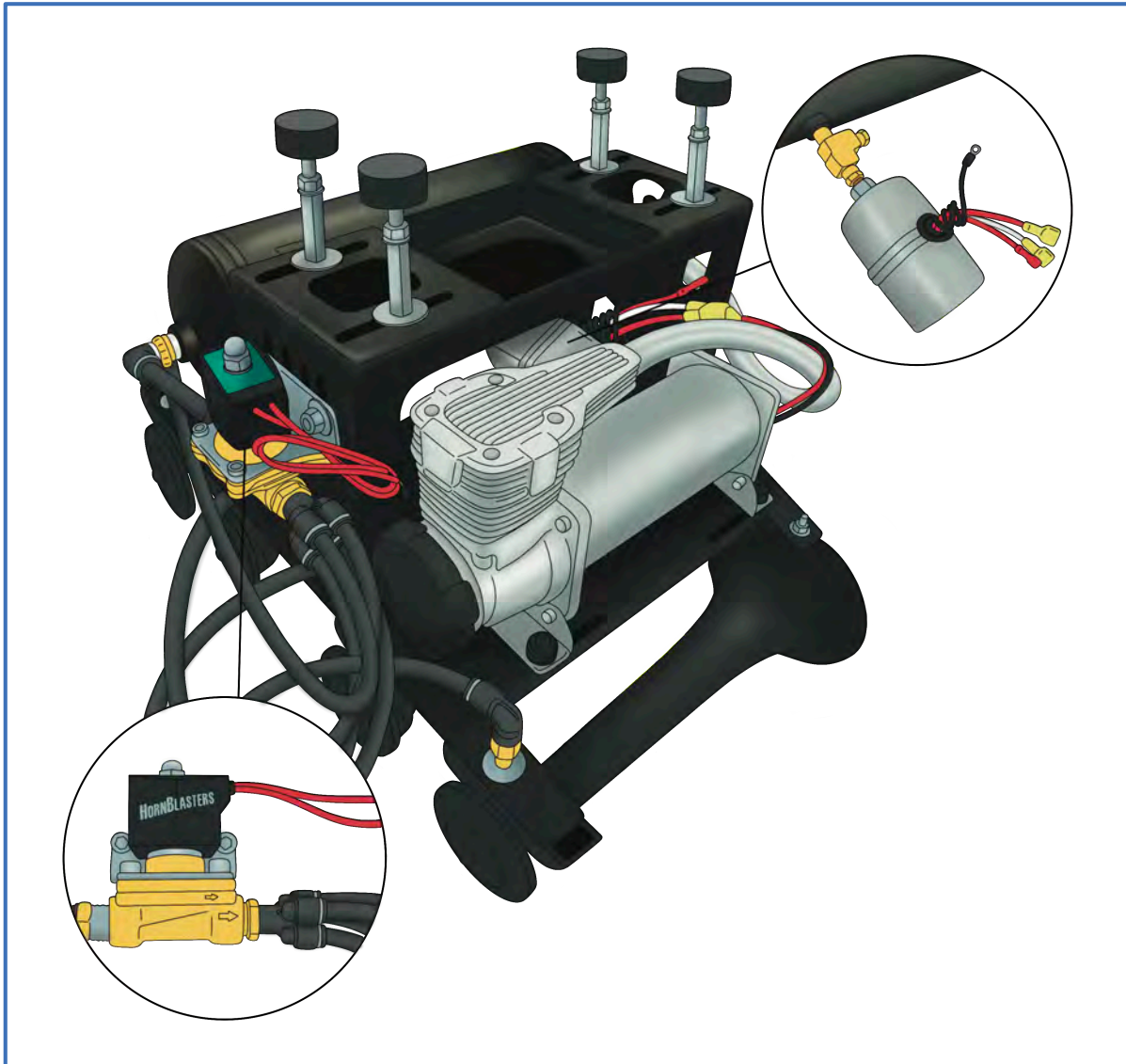

- 1.) Locate the compressor mounting hardware in the part box place the compressor in the bracket as shown in the photo above, aligning the mounting holes with the mounting slots on the bracket.
- 2.) Loosely tighten down the 4 bolts with a phillips head screwdriver and a $\frac{9}{32}$ " socket until the compressor sits snug.
- 3.) Apply teflon to the threads of the compressors check valve before wrapping it around the back side of the bracket then up into the tank on the side of the bracket where it can be tightened into the $\frac{3}{8}$ " street elbow.

⚠ WARNING: DO NOT OVER TIGHTEN THE CHECK VALVE, FINGER TIGHT + $\frac{1}{4}$ TURN ONLY.

- 4.) Once the check valve has been tightened down go back and finish fully tightening down the compressor mounting hardware.
- 5.) Remove the pressure switch from it's packaging and locate the center point on your tank. Using the $\frac{1}{4}$ " - $\frac{1}{8}$ " reducer and $\frac{1}{4}$ " run tee mount the pressure switch to the tank. Start by hand tightening the pressure switch into place followed by one half turn clockwise with a wrench.

⚠ WARNING: DO NOT OVER TIGHTEN THE PRESSURE SWITCH, FINGER TIGHT + $\frac{1}{4}$ TURN ONLY.

⚠ NOTE: Use Step 6.2 only with kit #HK-S2-232, 240 & 244

Step 6.2 COMPRESSOR & PRESSURE SWITCH MOUNTING 380C/400C/444C SERIES COMPRESSORS ONLY



- 1.) Locate the compressor mounting hardware in the part box place the compressor in the bracket as shown in the photo above, aligning the mounting holes with the mounting slots on the bracket.
- 2.) Loosely tighten down the 4 bolts with a phillips head screw driver and a socket until the compressor sits snug.
- 3.) Apply teflon to the threads of the compressors check valve before wrapping it around the back side of the bracket then up through the side of the bracket into the center where it can be tightened into the 1/4" Run Tee.

⚠ WARNING: DO NOT OVER TIGHTEN THE CHECK VALVE, FINGER TIGHT + 1/4 TURN ONLY.

- 4.) Once the check valve has been tightened down go back and finish fully tightening down the compressor mounting hardware.
- 5.) Remove the pressure switch from it's packaging and locate the front port on your tank. Using the 1/2" -1/8" reducer and mount the pressure switch to the tank. Start by hand tightening the pressure switch into place followed by one half turn clockwise with a wrench.

⚠ WARNING: DO NOT OVER TIGHTEN THE PRESSURE SWITCH, FINGER TIGHT + 1/4 TURN ONLY.



Step 7.) ASSEMBLE SPARE TIRE DELETE FEET & INSTALL THEM

For reference the photo to the left shows the order of the pieces for the spare tire delete feet as well as fully assembled. (4 feet total)

The photos below shows how to install the spare tire delete feet to the bracket.

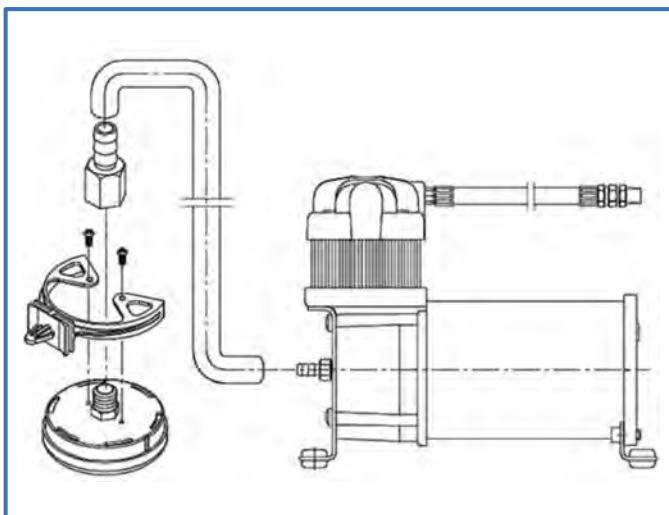
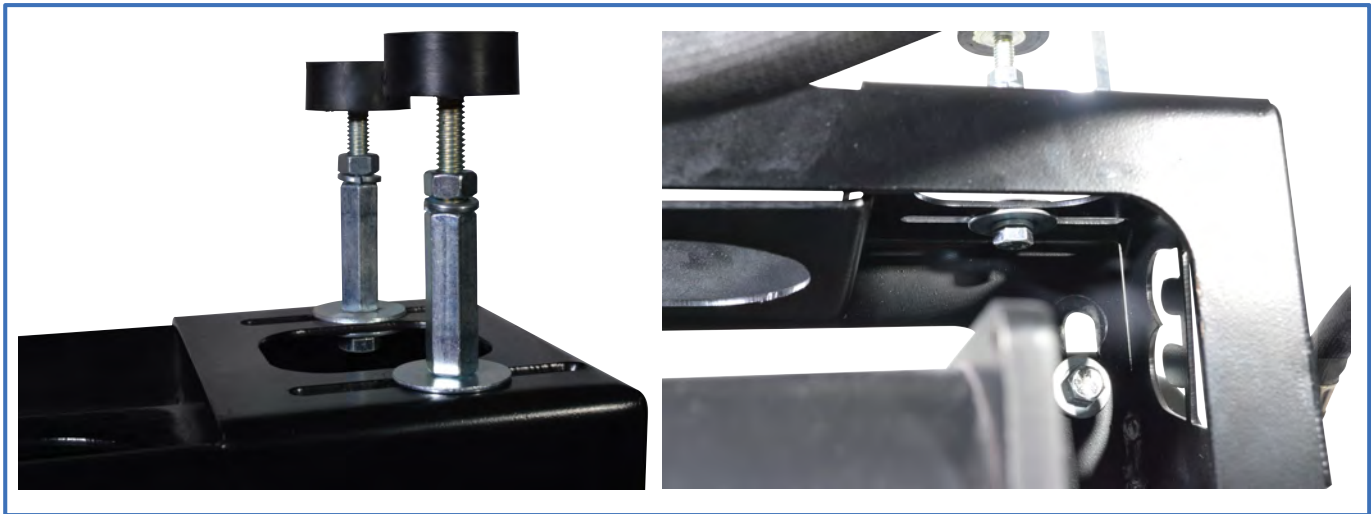

Step 8.) RELOCATE COMPRESSOR AIR FILTER

- 1.) Place remote mounting bracket onto inlet air filter assembly and line up attachment holes.
- 2.) Fasten bracket to inlet air filter with 2 screws provided.
- 3.) Screw $\frac{1}{2}$ " NPT (F) x $\frac{1}{2}$ " tube fitting onto inlet air filter, hand tighten. (No thread tape needed)
- 4.) Locate appropriate area where remote inlet filter is to be installed. Keep in mind that the location should be dry and away from heat sources. The air inlet slots on the inlet air filter must be free from blockage and NOT facing upward.
- 5.) Drill $\frac{3}{8}$ " mounting hole. Push the remote filter bracket pin into the hole.
- 6.) Screw $\frac{3}{8}$ " NPT (M) x $\frac{1}{2}$ " tube fitting onto the compressor's air inlet port, tighten with wrench. (No thread tape needed)
- 7.) Attached provided $\frac{1}{2}$ " air line to barbed tube fitting of air inlet port of compressor.
- 8.) Route air line to remote inlet air filter, measure and cut squarely to appropriate length, and attach to remote inlet air filter.

⚠ WARNING: FAILURE TO RELOCATE THE COMPRESSOR AIR FILTER OUT OF THE ELEMENTS COULD VOID YOUR WARRANTY. PLEASE DO NOT SKIP THIS STEP.

Step 9.) SAFETY CABLE MOUNTING

Attach safety cables to the top of the top of the bracket as seen in the photo below, once installed on the vehicle. Make sure the cables run through a solid mounting point under the vehicle.



⚠ NOTE: THIS DIAGRAM IS FOR WIRING PURPOSES ONLY, YOUR ACTUAL COMPRESSOR CONNECTION CONFIGURATION MAY BE DIFFERENT DEPENDING ON WHICH COMPONENTS YOUR KIT CONTAINS.

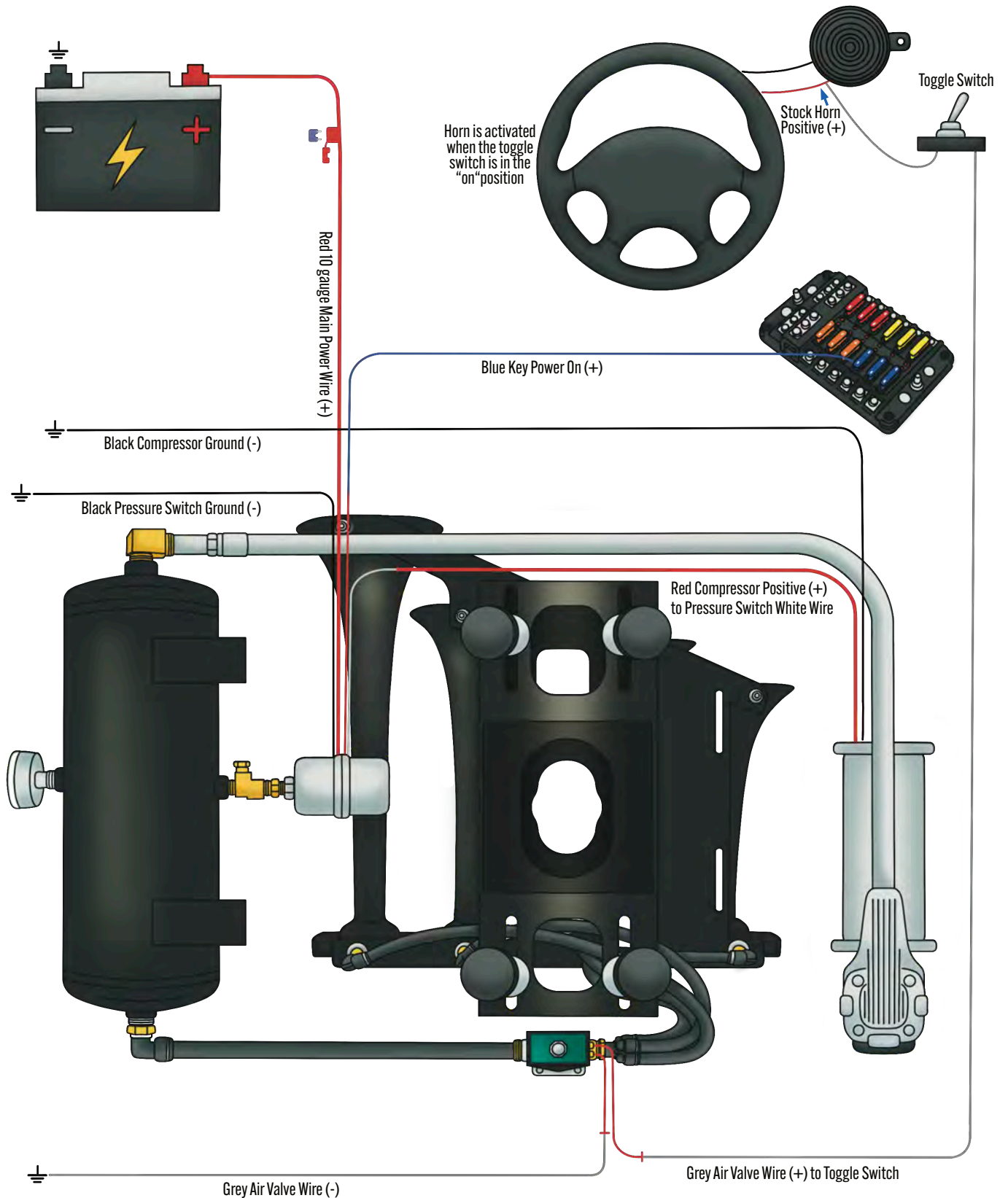

⚠ WARNING: To ensure the life of your system, reading and following these instructions are recommended. Make sure to change filters and to drain the moisture from the tank on a regular basis. Most factory horns are positively activated. If your horn system is negatively activated, then you will need to wire one of the leads from the valve to a direct 12v power source. Then wire the other lead to the negatively charged horn wire.

Step 10.) WIRING

Following the wiring instructions listed to the left in the diagram completely is crucial for the longevity of your system. One step that is extremely important in the wiring process is making sure the “trigger/switch positive” wire from the grey box pressure switch is tied into a key power-on” source, **not a constant power on source**. This will make sure that your compressor never receives power unless the vehicle ignition is in the “on” position, also protecting your pressure

Step 11.) ROUTINE MAINTENANCE

The only thing that needs to be done routinely on a bi-weekly basis is to drain your tank of any moisture that may have collected there over time. This can be done by turning the drain cock on the bottom of each tank clockwise until air and the moisture begins to flow out. Following this step greatly increase the longevity of the kit.

⚠ NOTE: DO NOT DRAIN MOISTURE FROM YOUR TANK USING THE SAFETY BLOW OFF VALVE. THIS UNIT'S MAIN PURPOSE IS TO RELEASE PRESSURE IN CASE YOUR PRESSURE SWITCH HAPPENS TO FAIL.

SINGLE TANK SPARE TIRE DELETE

INSTALLATION GUIDE

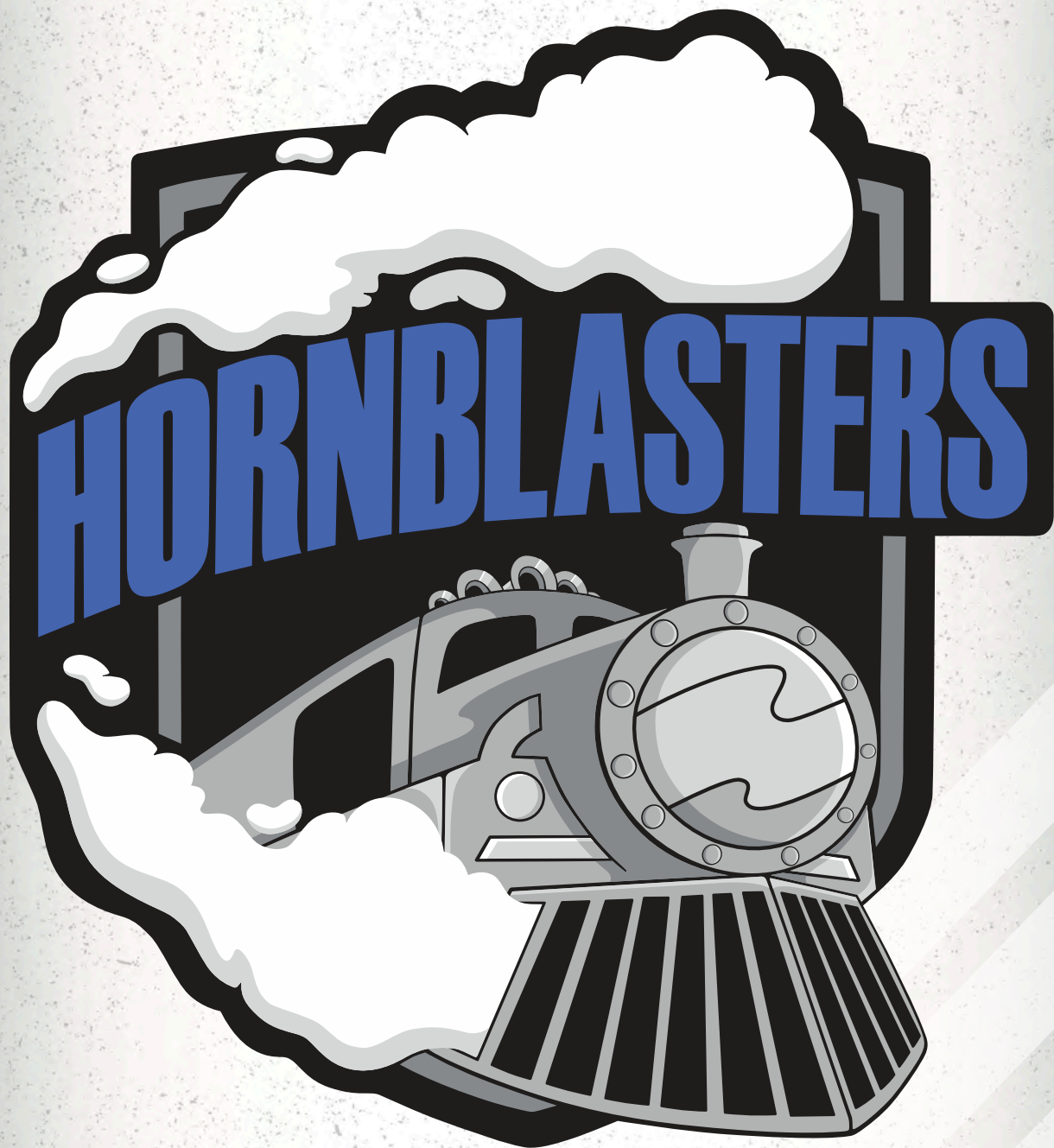

@hornblasters



*Failure to read these instructions
can result in an incorrect installation.*