



# Elite Series

## INVERTER POOL HEAT PUMP



USER'S MANUAL



# Table of contents

<b>A. Safety Precautions</b>	<b>1</b>
1. Warning	1
2. Attention	2
3. Safety	2
<b>B. About your heat pump</b>	<b>3</b>
1. Transportation	3
2. Accessories	3
3. Features	3
4. Operating condition and range	4
5. Introduction of different modes	4
6. Technical parameters	5
7. Dimensions	6
<b>C. Installation</b>	<b>7</b>
1. Installation requirements	7
3. Wiring requirements	8
4. Electric wiring Diagram	9
5. References for protecting devices and cable specification	9
<b>D. Operation guidance</b>	<b>10</b>
1. Display Functions	10
2. Operation Instruction	11
<b>E. Testing</b>	<b>13</b>
<b>F. Maintenance</b>	<b>14</b>
<b>G. Trouble shooting for common faults</b>	<b>16</b>
<b>H. Appendix</b>	<b>18</b>
<b>I. Wifi operation</b>	<b>22</b>

## A. Safety Precautions

---

We have provided important safety messages in this manual for the installation, maintenance and repair of your heater.

Please read thoroughly and obey all safety messages.

**Environmentally friendly R32 Refrigerant is used in this heat pump**

### 1. Warning

---



This WARNING sign denotes a hazard. It calls attention to a procedure, practice, or the like, which, if not correctly performed or adhered to, could result in personal injury or injury to a third party. These signs are rare, but are extremely important.

	a. Keep the heat pump away from fire source.
	b. Unit must be placed in a well-ventilated area; indoor or enclosed areas are not allowed.
	c. Repair and disposal must be carried out by trained service personnel
	d. Vacuum the system completely before welding. Welding should only be carried out by professional trained personnel.

## 2. Attention

---

- a. Please read the following instructions before installation, use and maintenance.
- b. Installation, must be completed only by competent persons only, and in accordance with this manual.
- c. Check all water connections are sealed and tested before operating the heat pump
- d. Except for the methods recommended by the manufacturer, do not use any methods to accelerate the defrosting process or clean the frosted parts.
- e. If a repair is required, please contact the nearest after-sales service center. The repair process must be strictly in accordance with this manual. Repairs made by unauthorized persons may void the warranty.
- f. Correctly set temperature required for personal preference making sure to avoid overheating or overcooling.
- g. Please do not stack substances or other materials which may block the air flows to the inlet or outlet areas. This causes the efficiency of the heater to be reduced, and may damage the machine.
- h. Do not use or stock combustible gas or liquids such as thinners, paint and fuel, to avoid fire!
- i. In order to optimize the heating effect, please install heat preservation insulation on pipes between swimming pool and the heater, and please use a recommended cover on the swimming pool.
- j. Connecting pipes of the swimming pool and the heater should be less than 10m.

## 3. Safety

---

- a. Please keep the main power supply out of reach from the children.
- b. If power is suddenly disconnected during operation, and later the power is restored, the heater will start up automatically.
- c. Please switch off the main power supply in high storm weather to prevent the machine from damage that could be caused by lightning strikes.
- d. Any repairs should be carried out in a well-ventilated area. Any source of ignition is prohibited during the inspection.
- e. Safety inspections must be carried before the maintenance or repair for heat pumps with R32 gas in order to minimize the risk.
- f. If R32 gas leaks during the installation process, all operations must be stopped immediately and call your local service center.

## B. About your heat pump

---

### 1. Transportation

---

a. Always keep upright

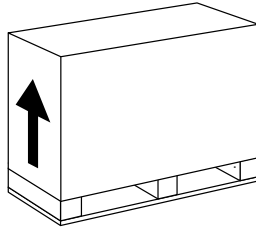

b. Do not lift with the water unions  
(The titanium heat exchanger  
inside the heat pump may be damaged)

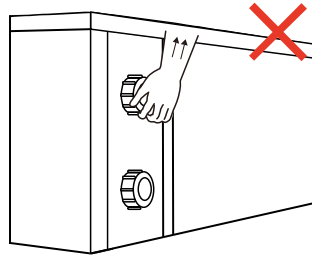

### 2. Accessories

---

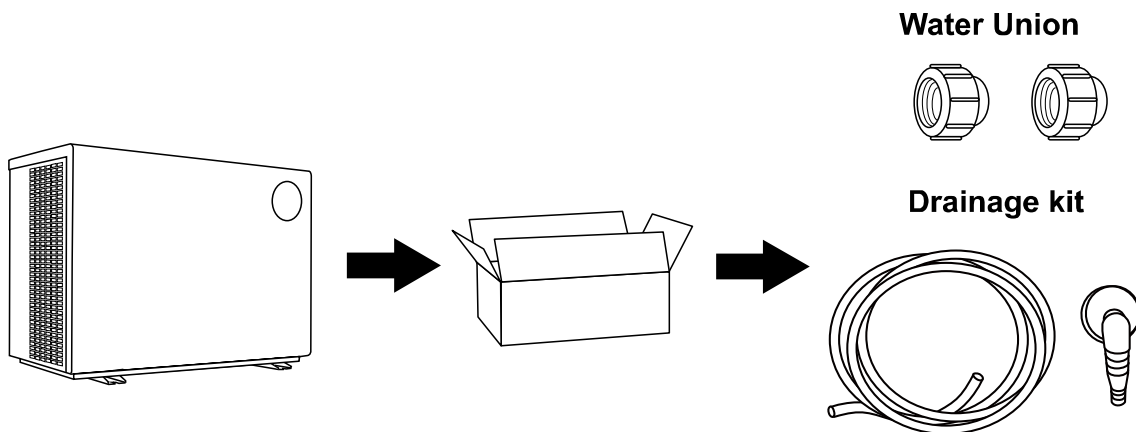

### 3. Features

---

- DC Twin-rotary inverter compressor of Mitsubishi
- DC Brushless fan motor
- EEV Technology
- Quick hot gas defrosting with Saginomiya 4-way valve
- High-efficiency twisted titanium heat exchanger
- Sensitive and accurate temp control and water temp display
- High pressure and low pressure protection
- Full protection on electrical system

#### 4. Operating condition and range

---



To provide you comfort and pleasure, please set swimming pool water temperature efficiently and economically.

- a. Air temperature operating range:  $-10^{\circ}\text{C} \sim 43^{\circ}\text{C}$
- b. Heating temperature setting range:  $18^{\circ}\text{C} \sim 35^{\circ}\text{C}$
- c. The heat pump will have best performance in operating temperature range of ambient Air  $15^{\circ}\text{C} \sim 25^{\circ}\text{C}$

#### 5. Introduction of different modes

---

- a. The heat pump has two modes: Boost and Silent
- b. They have different strengths under different conditions.

Mode	Modes	Strength
	Boost mode	Heating capacity: 20% to 100% capacity Intelligent optimization Fast heating
	Silence mode	Heating capacity: 20% to 80% capacity Sound level: 3dB (A) lower than Boost mode

## 6. Technical parameters

Model	ES70/ 240MM	ES90/ 240MM	ES110/ 240MM	ES130/ 240MM	ES150 /240MM	ES170/ 240MM	ES210/ 240MM	ES260/ 240MM	ES260S/ 400MM
<b>PERFORMANCE CONDITION: Air 27°C/ Water 27°C/ Humid. 80%</b>									
Heating capacity (kW)	7.0	9.0	11.0	13.0	15.0	17.0	21.0	26.0	26.0
COP Range	14~6.6	14~6.6	14~6.4	14.5~6.6	15~6.6	15~6.5	14.8~6.4	15~6.5	15~6.8
<b>PERFORMANCE CONDITION: Air 15°C/ Water 26°C/ Humid. 70%</b>									
Heating capacity (kW)	5.0	6.3	7.7	9.0	10.5	11.5	14.5	17.0	17.0
COP Range	7.3~4.4	7.0~4.4	7.5~4.5	7.5~4.5	7.7~4.6	7.8~4.6	7.1~4.6	7.5~4.6	7.5~4.6
<b>TECHNICAL SPECIFICATIONS</b>									
Advised pool volume (m <sup>3</sup> ) *	15~30	20~45	30~55	35~65	40~70	40~80	50~95	60~120	60~120
Operating air temperature (°C)	-10°C~43°C								
Power supply	230V 1PH								400V 3ph
Rated input power (kW)	0.14~1.14	0.19~1.43	0.21~1.71	0.25~2.0	0.29~2.28	0.29~2.5	0.41~3.15	0.51~3.7	0.51~3.7
Rated input current (A)	0.62~5.17	0.84~6.51	0.97~7.78	1.15~9.09	1.30~10.38	1.34~11.36	1.86~14.33	2.3~16.8	0.73~5.33
Maximum input current (A)	7.5	8.5	10	12	13.5	15	17	20	7
Sound level at 10m dB(A)	16.5~26.0	16.8~26.1	16.6~27.9	20.1~28.7	19.3~32	21.1~31.8	18.9~32.2	21.5~32.9	21.5~32.9
Advised water flux (m <sup>3</sup> /h)	2~4	2~4	3~5	4~6	5~7	6~8	8~10	10~12	10~12
Water connection (mm)	40								

### Remarks:

This heat pump is able to perform normal within air temp -10°C ~ +43°C, efficiency will not be guaranteed out of this range. Please take into consideration that the pool heater performance and parameters are different under various conditions.

Related parameters are subject to adjustment periodically for technical improvement without further notice. For the most up to date details please refer to nameplate on the heat pump.



## 7. Dimensions

---

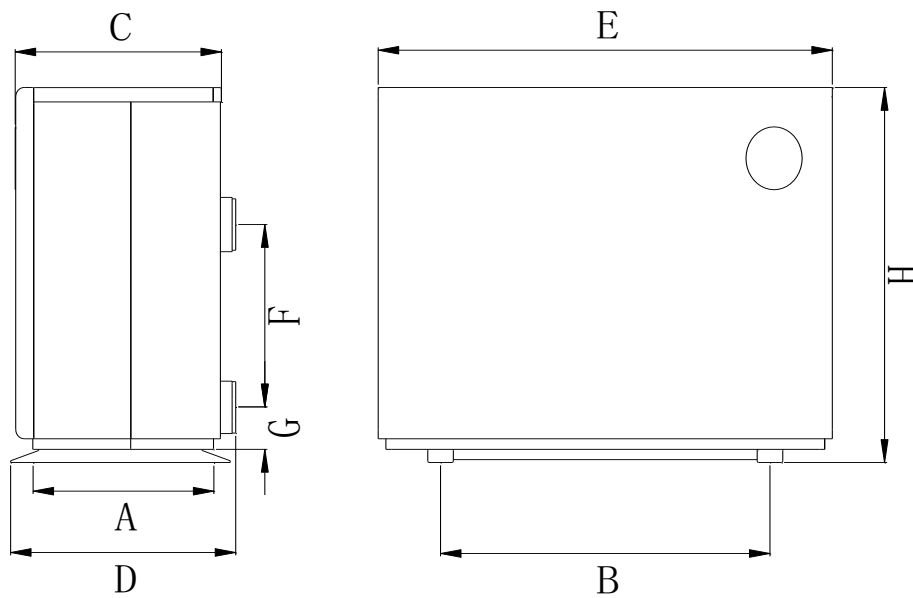

Size(mm) Name Model	A	B	C	D	E	F	G	H
ES70/ 240MM	410	645	404	440	890	250	75	658
ES90/ 240MM	410	645	404	440	890	250	75	658
ES110/ 240MM	410	645	404	440	890	290	75	658
ES130/ 240MM	410	645	404	440	890	280	75	658
ES150/ 240MM	410	645	404	440	970	320	75	658
ES170/ 240MM	410	710	404	440	1060	320	75	658
ES210/ 240MM	410	710	404	440	1060	460	75	758
ES260/ 240MM	410	710	404	440	1060	640	75	958
ES260S/ 400MM	410	710	404	440	1060	640	75	958

※ Above data is subject to modification without notice.

Note: The picture above and the specification diagram of the pool heater is for the technician's installation and layout reference only. The product is subject to adjustment periodically for improvement without notice.

## C. Installation

### 1. Installation requirements

---

Only competent persons are authorised to install the heat pump and should be educated with the relevant building codes and standards of their current state or local governing body for all electrical, mechanical and water services to prevent danger or damage to the unit.

#### a. Location and clearances



The inverter pool heat pump should be installed in a well-ventilated place.

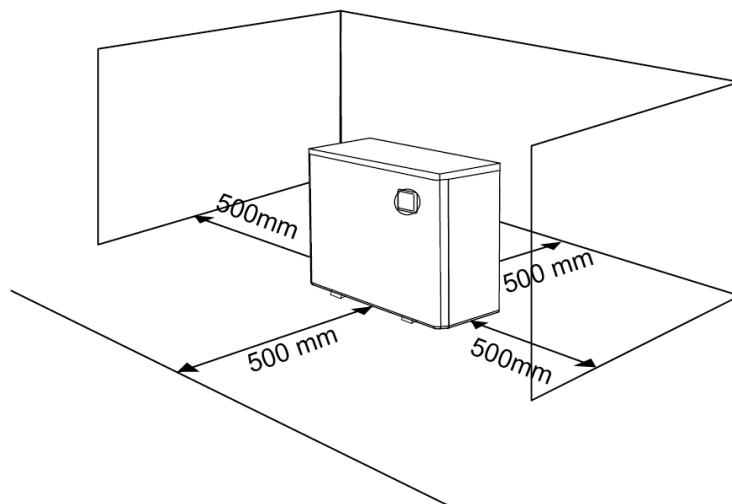

#### b. Typical installation diagram

Installations can differ dependent on site conditions below is only a representation of one possibility. Note: the inlet and outlet positions for the pipework is a representation only and can be positioned differently

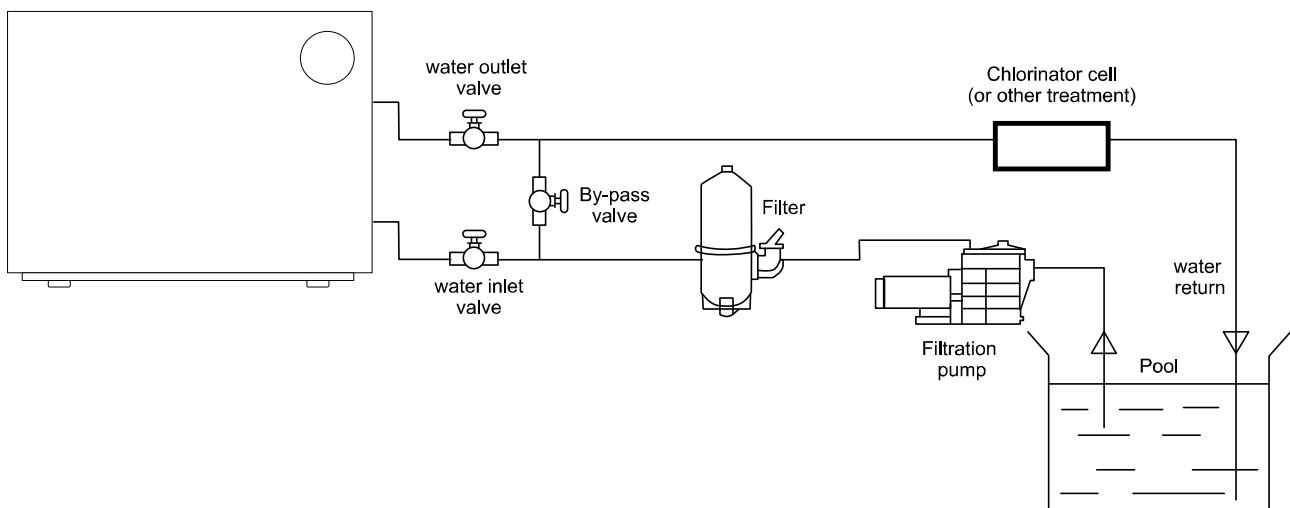

---

## 2. Placing the unit and water connections

---

### a. Placing the unit and fixing

- The frame must be fixed by bolts (M10) to a concrete foundation or brackets. The concrete foundation must be solid and fastened; the bracket must be strong enough and anti-rust treated.
- Do not stack substances that will block air flow near the inlet or outlet area, and there should be no obstruction within 50cm behind the machine. Suffocation of air reduces the efficiency of the heater and could damage the unit.
- The machine may need an additional pump (not supplied). The recommended pump must adhere to the specification-flux of the machine, please refer to the technical parameters.

### b. Water connections and condensation

- The inlet and outlet water unions should not be installed with soft flexible pipes. The heat pump **must** be connected with rigid pipes!
- When the machine is running, condensation is created and discharged from the bottom. Please place the drainage nozzle (accessory) into the hole and clip it well, then connect a pipe to drain the condensation water away.

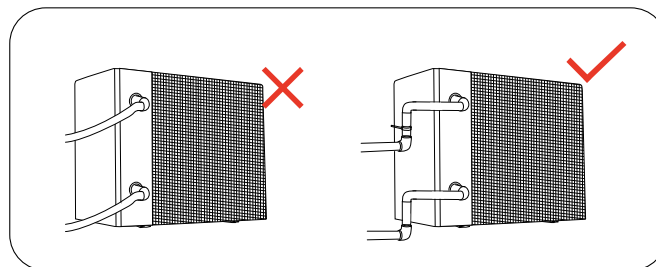

## 3. Wiring requirements

---

- a. Connect the heat pump to an appropriate power supply, the voltage should comply with the rated voltage of the product.
- b. The machine **must** be earthed
- c. Wiring must be handled by a professional technician according to the circuit diagram.
- d. Install electrical protection device according to local code for wiring
- e. The layout of power cable and signal cable should be orderly and not affecting each other.

#### 4. Electric wiring Diagram

---

##### a. For power supply: 230V 50Hz

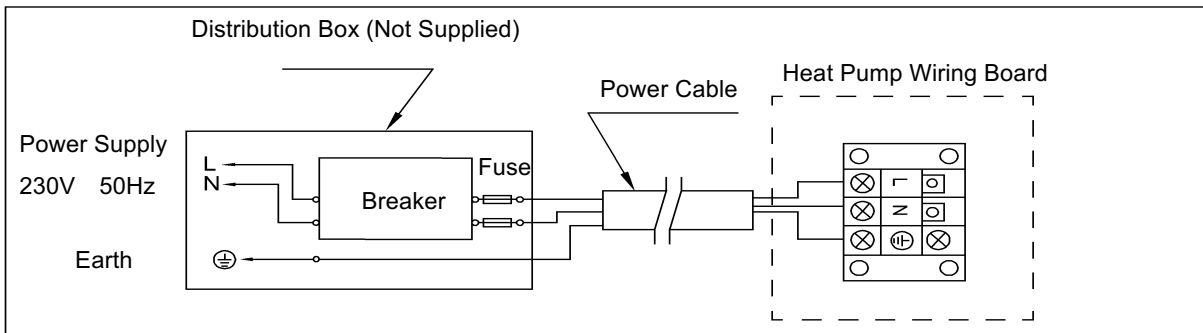

##### b. For power supply: 400V 50Hz

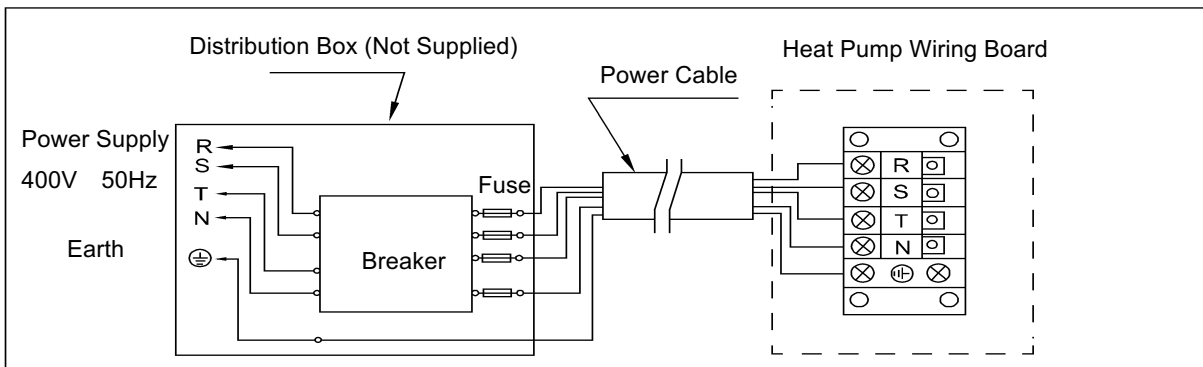

Attention: The pool heat pump must be earthed.

#### 5. References for protection devices and cable specification

---

MODEL		ES70/ 240MM	ES90/ 240MM	ES110/ 240MM	ES130/ 240MM	ES150 /240MM	ES170/ 240MM	ES210/ 240MM	ES260/ 240MM	ES260S/ 400MM
Breaker	Rated Current A	9	10.5	12	14.5	16.5	18	21	24	9
	Rated Residual Action Current mA	30	30	30	30	30	30	30	30	30

※Above data is subject to modification without notice.

**Note:** The above data is associated to power cables less than 10m. If the power cable is longer than 10m, the wire diameter must be increased in accordance with current regulations. The signal cable can be extended to a maximum of 50m.

## D. Operation guidance

---

### 1. Display Functions

---



Symbol	Designation	Function
	ON/OFF	Power On/Off WiFi setting
	Unlock	Lock/Unlock Screen
	Speed Mode	Two modes: Boost  Silence
	UP/DOWN	Temperature Setting & Displaying

- a. Standby mode or Screen lock: Only symbol lights up, screen and other buttons turn darker.
- b. Power off mode: Only symbol will light up, No display on screen.
- c. The controller has a power-saving mode and will not display bright when locked.
- d. The controller has a built-in memory so all parameters are saved in the event of power loss



## 2.Operation Instruction

---

### a. Screen Lock

- 1) Press  button for 3 seconds to lock or unlock the screen
- 2) Display automatically locks in no input is detected after 30 seconds.



### b. Power On

Press  for 3 seconds to unlock screen, Press  to power on machine.

### c. Temperature Setting

Press  and  to display and adjust set temperature.

### d. Mode Selection

Press  to switch between boost mode , silent mode 



Default mode is Boost 

Please choose boost mode  for initial heating

### e. WIFI

Download Inverquark app from Apple app store or Google Play store.

Set up new account, enter WiFi password and click add new device (Enter area code +61 when registering by phone number)



When the screen is unlocked, hold  button for 3 seconds, after  symbol will begin flashing.

WiFi connection process has now started on the unit.

Now press Bind Device on mobile device.

System should now have connected within the minute and now enjoy controlling the unit through WiFi.

When WiFi is connected  symbol is displayed.

To clear the WiFi setting history on machine. When the screen is on, press and hold  for 10 seconds,  symbol will flash fast for 10 seconds then switch off.

#### d. Defrost cycle



- Automatic active defrosting

When the machine is operating in low temperatures it is very common for ice to build up on the external coil. The heat pump has a built in defrost protection program which will activate when it senses ice starting to form.

When machine is defrosting, ☀ starts flashing; after defrosting ☀ is on continuously

- Forced defrosting,

If the heat pump requires manually defrosting for testing or a sensor is faulty please follow these instructions, the machine must be in heating mode and the compressor is working continuously for

more than ten minutes, Whilst the unit is running, press  and  on the

controller simultaneously and hold for 5 seconds. When the ☀ symbol is flashing, defrost has

started, and will continue until the external coil temperature reaches a certain temperature adequate

for continued operation. If the ☀ symbol stops flashing forced defrost has stopped.

\*Note: the interval between forced defrosting should be more than 30 minutes apart.

## E. Testing

---

### 1. Heat pump checks before use

- a. The air inlets and outlets are free of any debris and are not obstructed.
- b. Refrigeration pipes or components are not installed in a corrosive environment.
- c. Check electric wiring connections are tight and adhere to the electrical schematic
- d. Check for water leaks around the machine and all new water connections

### 2. Refrigerant leak detection





- a. Leak testing is prohibited in enclosed areas
- b. Any source of ignition is prohibited during leak checks.
- c. Leak detection fluids can be used with most refrigerants but the use of products containing chlorine should be avoided as the chlorine may react with the refrigerant and corrode the copper pipe.
- d. Vacuum the machine completely before welding. Welding should only be carried out by a professional person in a service center.
- e. Please stop immediately if a gas leak occurs, and contact your local service center.

### 3. Trial Run

- a. The circulation pump must start before the heat pump and stop after the heat pump to avoid any damage occurring to the machine.
- b. In order to protect the heat pump, the machine is equipped with a time lag start function, the fan will run 1 minute earlier than the compressor when starting the machine, and it will stop running 1 minute later than the compressor when power off the machine.
- c. After the heat pump starts, check for any abnormal noises from the machine.

Running status codes and corresponding values

### 4. Running status check

- a. Press and hold  for 5 seconds, a beep sound should be heard and it will enter into running status mode
- b. Use  and  to switch through the different values
- c. Press  again to quit can running status mode

Symbol	Content	Unit
C0	Inlet water temp	°C
C1	Outlet water temp	°C
C2	Ambient temp	°C
C3	Exhaust temp	°C
C4	Outer coil pipe temp	°C
C5	Gas return temp	°C
C6	Inner coil pipe tem	°C
C9	Radiator temp	°C
C10	Electronic expansion valve opening	P



## F. Commissioning

---

### 1. Flow Rates

Each Pool Heat Pump has a minimum flow rate requirement please check the specification table water flux section to ensure the circulation pump in use is adequately sized.

Calibrating the flow rate.

By using the running status function on the touch controller, it is easy to calibrate the check valves installed for optimum flow rates through the heat pump.

#### **OPTIMUM FLOW RATE DIFFERENTIAL FROM INLET TO OUTLET IS BETWEEN 2-3 DEGREES**

Madimack Heat Pumps have a built-in flow switch which will deactivate the heating function if not enough water flow is detected. The Heat Pump has a large range operation up to a seven-degree differential. If the temperature differential is above 7 degrees, the flow switch or E6 Error will be displayed indicating not enough flow detected.

Recommended procedure

- a. Fully open all valves including the by-pass and switch the unit on to max temp.
- b. If Error E3 is displayed slowly close by pass valve until unit initiates.
- c. Wait 3-4 minutes until heat pump is at 100% Capacity
- d. Check inlet and outlet temperature through on screen controller running status check
- e. Open the by-pass valve to increase temperature differential
- f. Close the by-pass valve to decrease temperature differential
- g. Once optimum temperature achieved lock position of by-pass if possible.

## G. Maintenance

---



**“SWITCH OFF”** power supply to the heater  
before cleaning, examination or repairing

1. In the winter season when unit is not operating for long periods of time or if prone to freezing.
  - a. Switch off all power supply to prevent any machine damage.
  - b. Drain water completely from the machine.
  - c. Cover the machine body when not in use.

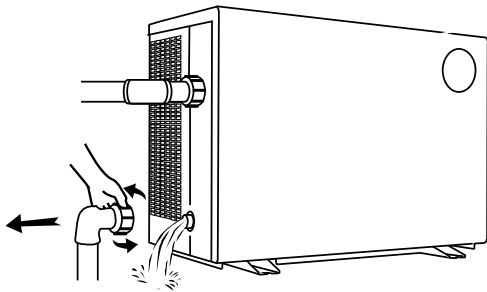

**!!!Important:**

Unscrew the water nozzle of inlet pipe to let the water flow out.

*When the water in machine freezes in winter season, the titanium heat exchanger may be damaged.*

2. Only clean this machine with household detergents or clean water, NEVER use gasoline, thinners or any similar fuel.
3. Check bolts, cables and connections regularly.
4. If repairs or removal is required, please contact an authorized service center.
5. Do not attempt to work on the equipment by yourself. Improper operation may cause danger.
6. To reduce risks, safety inspections must be carried out before the maintenance or repairing for heat pumps with R32 gas.

## H. Trouble shooting for common faults

---

### 1. Repairing Guidance

---



**WARNING:**

If repairs or removal is required, contact authorized service center.

#### Requirements for Service Personnel

- a. Any person who is involved with working on or breaking into a refrigerant circuit should hold a current valid certificate from an industry-accredited assessment authority, which authorizes their competence to handle refrigerants safely in accordance with an industry recognized assessment specification.
- b. Do not attempt to work on the equipment by yourself. Improper operation may cause danger.
- c. Strictly comply with the manufacturer's requirements when charging R32 gas and equipment maintenance. This chapter focuses on special maintenance requirements for swimming pool heat pump with R32 gas. Please refer to the technical service manual for detailed maintenance operation.
- d. Vacuum system completely before welding. Welding should only be carried out by professional person in a service center.

### 2. Problems without an error code

---

Failure	Reason	Solution
<b>Heat pump doesn't run</b>	No power	Wait until the power recovers
	Power switch is off	Switch on the power
	Fuse is broken	Check and change the fuse
	The breaker is off	Check and turn on the breaker
<b>Fan running but with insufficient heating</b>	Evaporator blocked	Remove the obstacles
	Air outlet blocked	Remove the obstacles
	3-minute start delay	Wait patiently
<b>Display normal, but no heating</b>	Set temperature too low	Set proper heating temp.
	3-minute start delay	Wait patiently
If above solutions don't work, please contact your installer with detailed information and your model number. Please don't try to repair it yourself.		

**Note:** If the unit frequently breaks the circuit breaker, please stop the machine immediately by switching off the main power and contact your dealer or local repair centre.

1. The fuse is frequently broken
2. Leakage circuit breaker activated

## Protection & Failure code

NO.	Display	Protection code description
1	E3	No water flow protection
2	E5	Power supply excesses operation range
3	E6	Excessive temp difference between inlet and outlet water. Insufficient water flow protection
4	Eb	Ambient temperature too high or too low protection
5	Ed	Anti-freezing reminder
NO.	Display	Failure code description
1	E1	High pressure protection
2	E2	Low pressure protection
3	E4	3 phase sequence protection (three phase only)
4	E7	Water outlet temp too high or too low protection
5	E8	High exhaust temp protection
6	EA	Evaporator overheat protection (only at cooling mode)
7	P0	Controller communication failure
8	P1	Water inlet temp sensor failure
9	P2	Water outlet temp sensor failure
10	P3	Gas exhaust temp sensor failure
11	P4	Evaporator coil pipe temp sensor failure
12	P5	Gas return temp sensor failure
13	P6	Cooling coil pipe temp sensor failure
14	P7	Ambient temp sensor failure
15	P8	Cooling plate sensor failure
16	P9	Current sensor failure
17	PA	Restart memory failure
18	F1	Compressor drive module failure
19	F2	PFC module failure
20	F3	Compressor start failure
21	F4	Compressor running failure
22	F5	Inverter board over current protection
23	F6	Inverter board overheat protection
24	F7	Current protection
25	F8	Cooling plate overheat protection
26	F9	Fan motor failure
27	Fb	Power filter plate No-power protection
28	FA	PFC module over current protection

## H. Appendix

### Water pump: 230V voltage & less than 10A

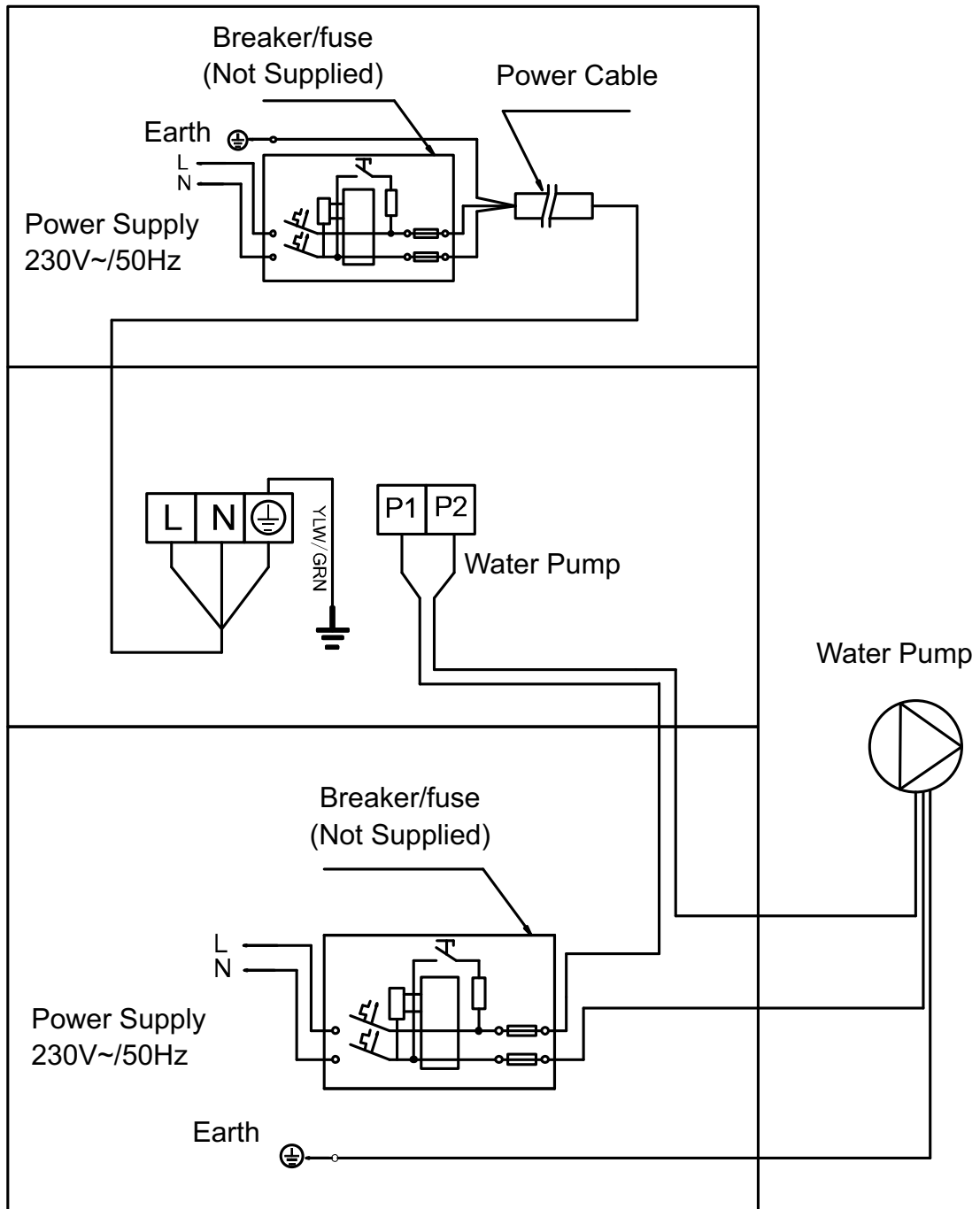

# Water Pump: 230V voltage & more than 10A

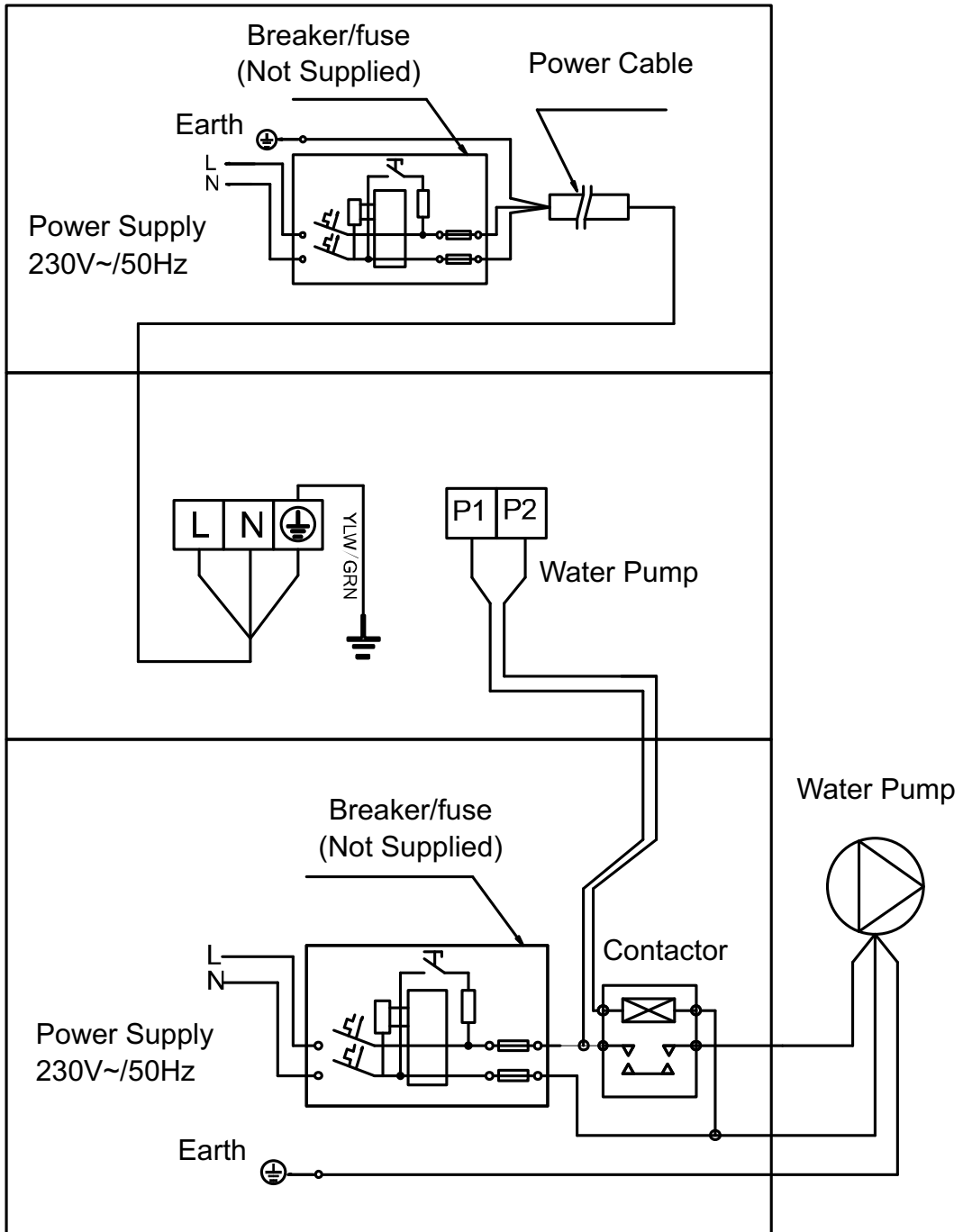

# Water Pump: 400V voltage

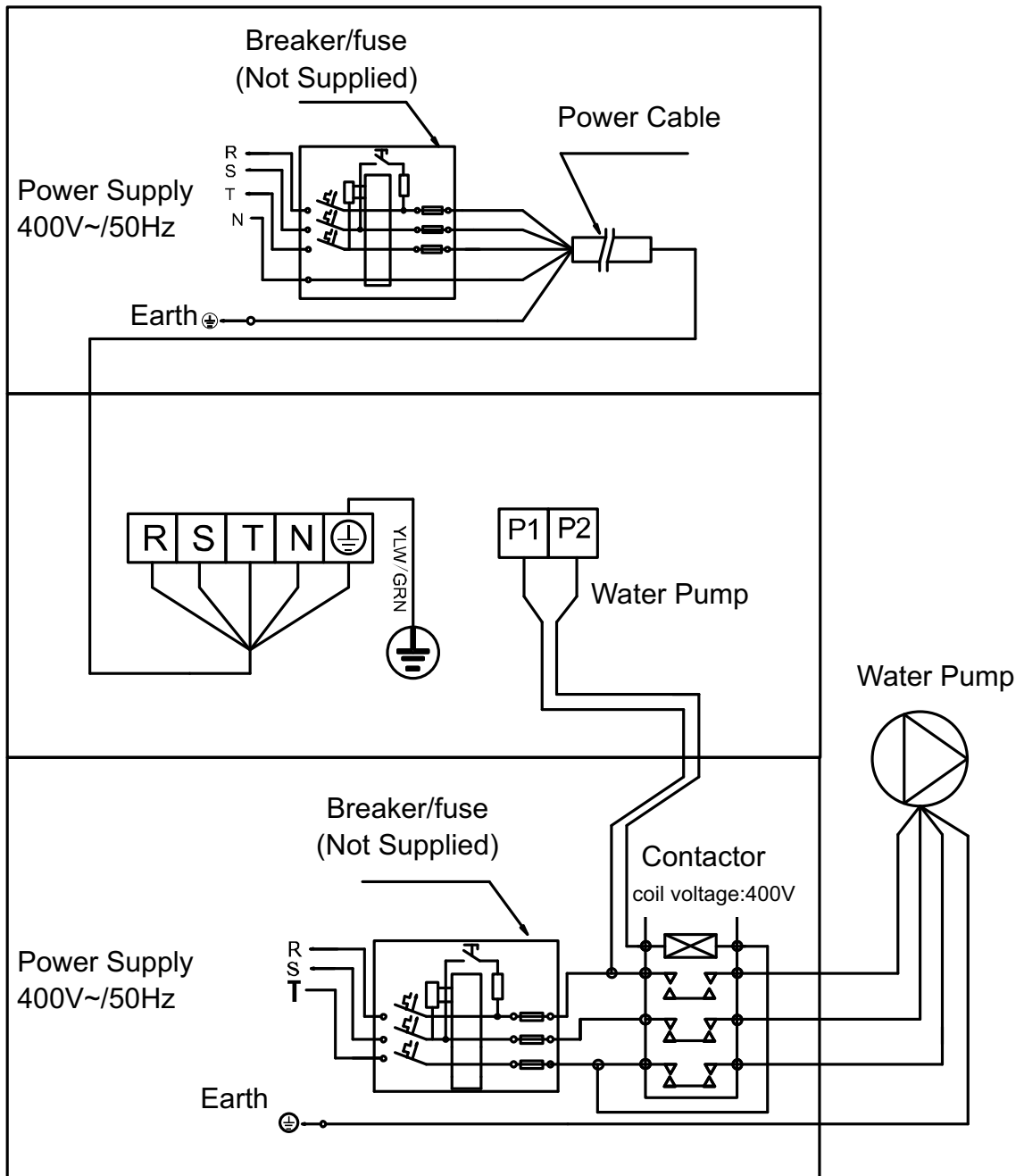



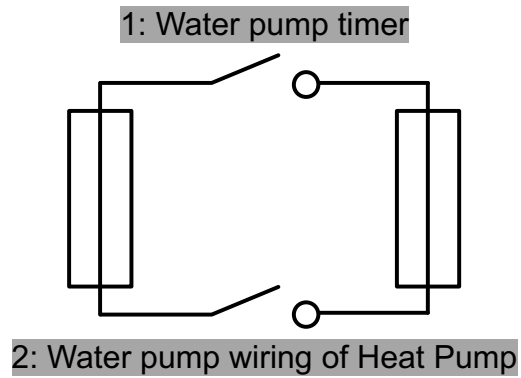

## Water pump control and timer connection





Note: The installer should connect 1 parallel with 2 (as above picture). To start the water pump, condition 1 or 2 is connected. To stop the water pump, both 1 and 2 should be disconnected.



# I. WiFi operation

1. APP Download	2. APP Binding
	
<p>Android mobile please download from</p>	<p>a. Press  for 3 seconds, display will beep to signal WiFi is activated. When APP has connected to WIFI successfully  light stays on. When using APP to control the machine  will flash</p>
<p>ANDROID APP ON <b>Google play</b></p>	
<p>iPhone please download from</p>	
<p>Available on the <b>APP Store</b></p>	

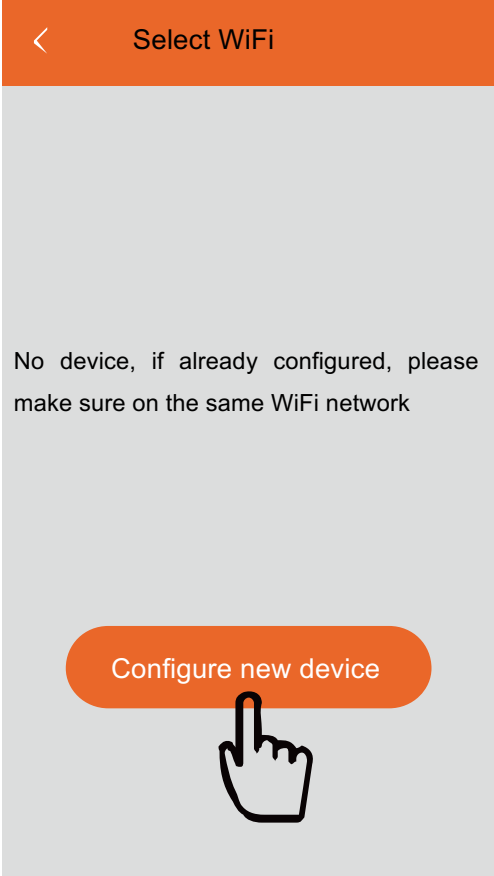
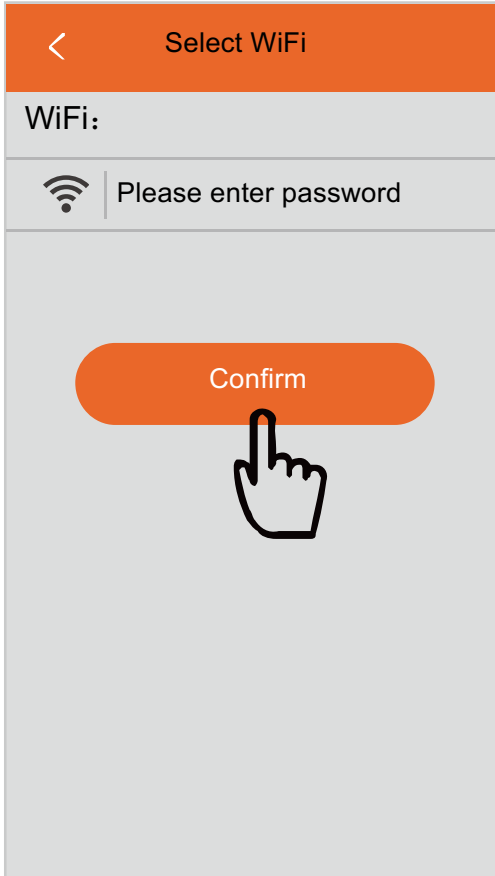
**b. Enter "Configure new device" in App, and follow display instructions to finish binding.**

 <p>Select WiFi</p> <p>No device, if already configured, please make sure on the same WiFi network</p> <p><b>Configure new device</b></p>	 <p>Select WiFi</p> <p>WiFi:</p> <p> Please enter password</p> <p><b>Confirm</b></p>
--	--

### 3. Operation (Heating Only)



### 4. Operation (Heating & Cooling)



#### Notice:

1. If the WiFi signal does not cover machine, please expand WiFi network.
  2. The weather forecast is for reference only
- APP is subject to updating without notice.



