

ASTRALPOOL 

Viron eEquilibrium Salt Chlorinator

INSTALLATION AND OPERATING INSTRUCTIONS





Melbourne: 03 8796 8600
Sydney: 02 9853 2100
Brisbane: 07 3308 5400

Gold Coast: 07 5552 2600
Townsville: 07 4750 3100
Adelaide: 08 8152 7600

Perth: 08 9350 2600
sales@astralpool.com.au
www.astralpool.com.au

A division of
FLUIDRA



 The appliance is not intended for use by young children or infirm persons without supervision. Please ensure that young children are supervised to ensure that they do not play with the appliance.

 Controller must be installed according to AS 3000 wiring rules.

 If the supply cord is damaged it must be replaced by AstralPool or its service agent or a similar qualified person in order to avoid a hazard.

 This product is NOT suitable for use on Spa Pools UNLESS the OPTIONAL pH sensor has been purchased and installed.

 When used on Spa Pool applications, AstralPool strongly recommend the purchase and installation of a chlorine sensor in addition to the pH sensor.

 This product is NOT suitable for use on Indoor swimming pools UNLESS the pH and Chlorine sensors have been purchased and installed.

 The Viron e-Equilibrium can only be purchased through a professional pool business and MUST be installed by that dealer.

 Dose pool with a small amount of chlorine before starting the eQ. If no chlorine is sensed the eQ may go to fail safe mode and not start up. Some Chlorine should be present before starting the unit.

 Take extreme care when handling the pH adjuster which is either sulphuric acid or hydrochloric acid. Wear gloves, eye protection and breathing protection.

 Before installing probes, balance pool water. Total Alkalinity (TA) must be 80 to 120 ppm, Calcium Hardness should be 180 to 250 ppm, and pH must be between 7.2 and 7.6.

 Cyanic Acid, sometimes referred to as stabiliser or sunscreen will suppress the Chlorine (ORP) reading when the Chlorine sensor is connected. Refer to section on setting chlorine levels if Cyanuric Acid is present in your pool.

Contents

Introduction.....	4
1.1 Components with Viron eQuilibrium Basic Chlorinator System.....	4
2.0 Installation Viron Equilibrium chlorinator	5
2.1 pH levels	5
2.2 Mounting the Controller.....	5
2.3 Connecting the PVC Acid Tube	7
3.0 Starting your Chlorinator	8
3.1 Set up	8
3.2 Setting Timers	8
3.3 Timer Recommendations:	9
4.0 Operating Functions Accessed through Maintenance Program	9
5.0 Calibration of pH Sensor/Probe:.....	11
6.0 OPERATION.....	12
6.1 Adjusting Chlorine Output.....	12
6.2 Adjusting pH Set Point.....	13
6.3 Installation of the pH sensor	13
6.4 Installation of the Chlorine Sensor	15
7.0 General Operation/Pool Chemistry.....	16
7.1 Setting the Right Chlorine Output and Filtration Time.....	16
Summer	16
Winter.....	16
7.2 Checking Chlorine Level.....	16
7.3 Stabiliser	16
7.4 pH Level	16
7.5 Total Alkalinity	16
7.6 Salt Level.....	16
7.7 ACID Handling.....	16
8.0 Maintenance of pH and chlorine sensors and dosing tubes	17
8.1 Acid Pump squeeze tube	17
8.2 Sensors:.....	17
8.3 Swimming Pool Applications and the use of Cyanuric Acid.....	17
9.0 Ai Mode – complete automatic control of your pool & Spa	17
9.1 Ai Equipment requirements	17
9.2 Ai Mode Connection	17
9.4 Viron eVo Pump speed selection:.....	18
9.5 Operation in Ai Mode	18

11.0 Fault Indication and trouble shooting22

12.0 WARRANTY23

Introduction

Congratulations on your purchase of the Viron series salt chlorinator. The correct pH balance of your pool water significantly increases the effectiveness of the chlorine in the water and if not maintained at the correct level, can cause harm to the interior finish of your swimming pool or spa and reduce the disinfection time of the chlorine.

The purpose of the Viron eQuilibrium series chlorinators is to significantly reduce the level of daily and weekly maintenance required to keep you pool and spa sparkling clean and healthy to swim in.

These installation and operating instructions will guide you through installation, operation and maintenance of your new chlorinator. Regular maintenance will ensure many years of trouble free operation.

1.1 Components with Viron eQuilibrium Basic Chlorinator System

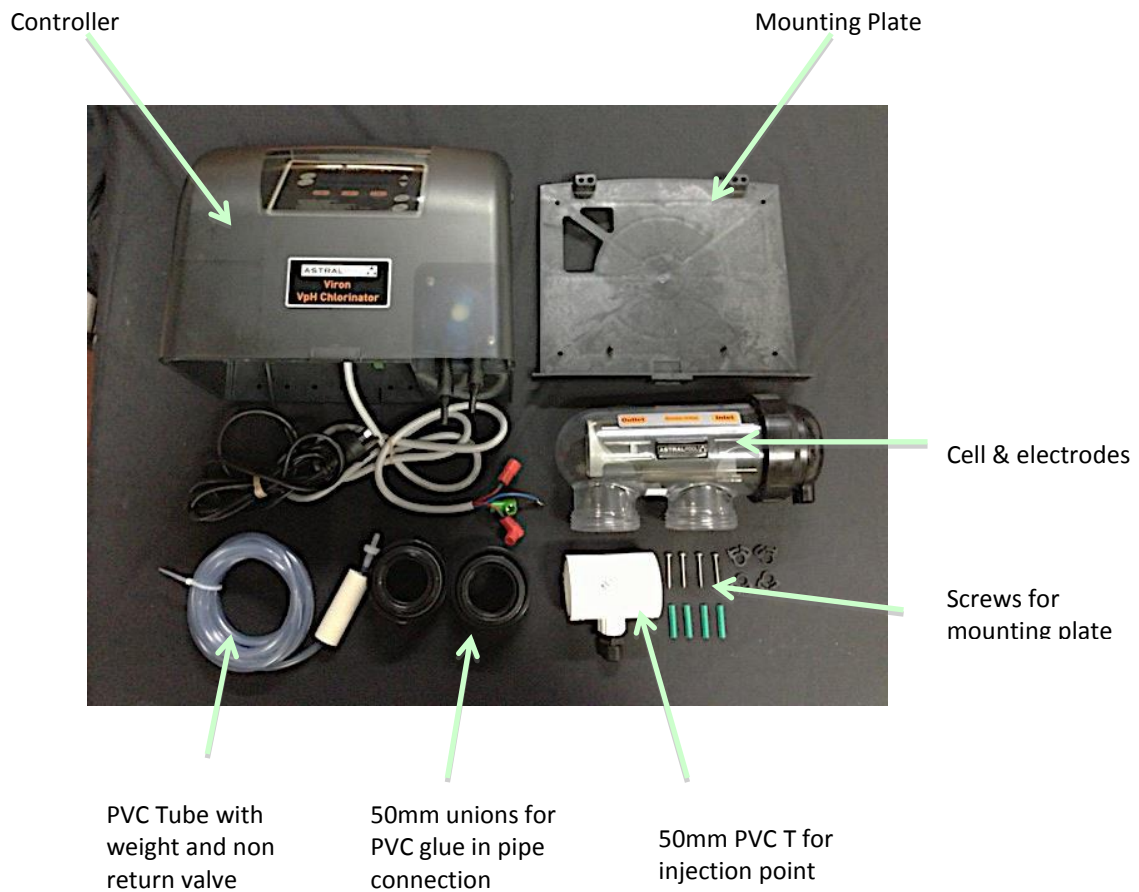

2.0 Installation Viron Equilibrium chlorinator

The Viron eEquilibrium Chlorinator incorporates a controller with inbuilt acid pump, a electrode cell for converting minerals or salts into chlorinator, a mounting plate for the controller and tubes, weights and injection points for the acid which controls your pool water pH. The intelligent software allows you to select and change your acid dosing ratio and intelligently adjusts the dose rate to match the output of the electrode. (the higher the output, the faster the pH will change and the more the controller will dose acid to compensate). However, you **MUST** test your pH every day for the first week and adjust your acid dose rate on the controller to achieve the correct pH level.

2.1 pH levels:

Generally you should aim to have your pH at 7.4 to 7.8. The actual pH you choose for your pool will depend on the water quality in your area, the interior finish of your pool and the type of pool you have.

2.2 Mounting the Controller:

Choose a location that is preferably out of direct sunlight, near the filter system. The controller should be located 1 metre above ground level to prevent rain splash back or sprinkler system damage to the underside of the controller. The controller must be mounted on a vertical surface/wall. If mounted on a post, a flat sheet 20mm larger than the controller housing must be used.

- Mount the wall bracket using the screws provided on a secure wall.
- Glue mixing cell for probe and acid injection point into plumbing line after filter and gas heater (if installed) but prior to chlorinator cell. **Mixing cell must be plumbed to ensure probe is horizontal to water flow.**
- Glue Chlorinator cell into line as per drawing below after filter, heater, solar (if installed) and after sensor T price.
- Plug the pH sensor into the underside of the controller in the location marked "pH"
- Plug filter pump 3 pin plug into underside of Controller
- Connect 4 wire cell cable ensuring matching colours.
- Remove cap from pH sensor and screw firmly into mixing cell installed in the plumbing. Do Not Overtighten.
- The cell **must** be installed with the barrel unions underneath and the cell should be horizontal. Both 40mm and 50mm fittings have been provided. Make sure that the o'rings are correctly fitted and the unions are done up tightly. Flow direction through the cell is critical – refer to label on housing.
- Hang Controller on wall bracket and plug power supply lead into 3 pin 10 amp outlet.



- NEVER MIX CHEMICALS
- CHEMICALS MUST BE STORED IN ACCORDANCE WITH RELEVANT STANDARDS AND DANGEROUS GOODS CODES. CONSULT YOUR AUTHORISED BUILDER OR POOL SHOP TECHNICIAN FOR ADVICE.
- WHEN HANDLING ACID, SAFETY GLOVES AND GOGGLES SHOULD ALWAYS BE USED
- FOR BEST RESULTS, USE OF NEAT ACID IS RECOMMENDED



2.3 Connecting the PVC Acid Tube

Before installing the unit in position on the wall or post, the length of the PVC tubing provided should be measured and taken into consideration. Ensure the controller and cell are close enough for the power supply lead to reach the cell and sufficient PVC tube exists to connect acid container and cell. To avoid loss of water from the system, close all stop valves before cutting any lines.

Thread the clear PVC tube through a hole in the cap or shoulder of the chemical container and fit the non-return or check valve and the weight. Ensure that the non-return valve is fitted correctly. Drop the weight, with the non-return valve into the bottom of the container.

The clear PVC tube should be snugly fit in the hole in the cap or shoulder of the chemical container. A small 2mm breather hole should be made in the cap or shoulder to allow air to fill the void created by the acid pumped into the pool.

Connect the other end of the PVC tube to the inlet of the acid pump on the front of the controller.

Connect the remaining hose to the outlet of the acid pump on the underside of the controller. The remaining end of the PVC hose should be pushed through the cable gland in the 50mm PVC T fitting so that it passes through the cable gland by 25mm to 30mm.

Locate the Mixing Cell (diagram below) in a horizontal position with the "Locate to Top" embossing in the 12 o'clock position after the Chlorinator cell on the return to pool side. Glue in 50mm PVC pipe into barrel unions tails or use 50 x 40mm reducers in the barrel union tails if existing plumbing is 40mm high pressure PVC pipe. Alternatively, locate the mixing cell in a vertical position after the chlorinator cell on the return side to the swimming pool.

TIP: Soaking the ends of the PVC tubing in hot water or gentle heating with a lighter makes it easier to push onto the barb. When installing acid container in a filter enclosure, which has no ventilation, it is recommended that the hole in the cap of the container is cut or drilled to fit tightly around the tubing, so that fumes from the acid will not corrode the equipment. It will be necessary to drill a second hole in the cap fitted tightly with a length of tubing which should then be vented outside the filter enclosure. This procedure is recommended only where the filter enclosure has no ventilation and is to protect the equipment.

ITEM NO.	PART NUMBER	DESCRIPTION	QTY.
1	50mm THREADED REDUCING TEE		1
2	2030053		1
3	2030055		1
4	2030056		1
5	Dosing Tube		1

DRAWING STANDARD A.S. 1100
 UNLESS OTHERWISE SPECIFIED
 DIMENSIONS IN mm SURFACE FINISH: 1.6µm
 GENERAL TOLERANCES
 LINEAR: ±0.2, 0.4, 0.5, 0.8, 1.0, 1.5, 2.0, 3.0, 4.0, 5.0, 6.3, 8.0, 10.0, 12.5, 16.0, 20.0, 25.0, 31.5, 40.0, 50.0, 63.0, 80.0, 100.0
 ANGULAR: ±0.1°, 0.2°, 0.5°, 1.0°

DO NOT SCALE DRAWING

REVISION:

DESCRIPTION:

PART NUMBER:

DWG NO: Single Point INJ T piece A3

SCALE: SHEET 1 OF 1

WEIGHT:

DATE: BY:

CHANGE DESCRIPTION:

REV: 1

3.0 Starting your Chlorinator

Your Chlorinator Controller operation can be divided into 4 areas;

- MAINTENANCE – selects specialised functions of your chlorinator and initial set up of Chlorinator to suit your pool and spa.
- SET – selects changes in Chlorine Product and pH of your pool and spa water
- CLOCK & TIMER buttons – sets current time and filtration, chlorine production and pH monitoring and adjustment times from Monday to Friday and Weekends
- Pool and Spa Mode – Allows selection of pool mode where controller will produce chlorine suitable for pool and Spa Mode, where chlorine production and acid dosing is reduced to suit a smaller volume of water in the Spa.

3.1 Set up

- Press “**Pool Mode**” button until **Manually Off** appears and then Press “**Clock**” Button
- Select “**Day**” and use buttons adjacent to LCD screen to set the current day, hour and minute. The clock is a 24 hour clock.

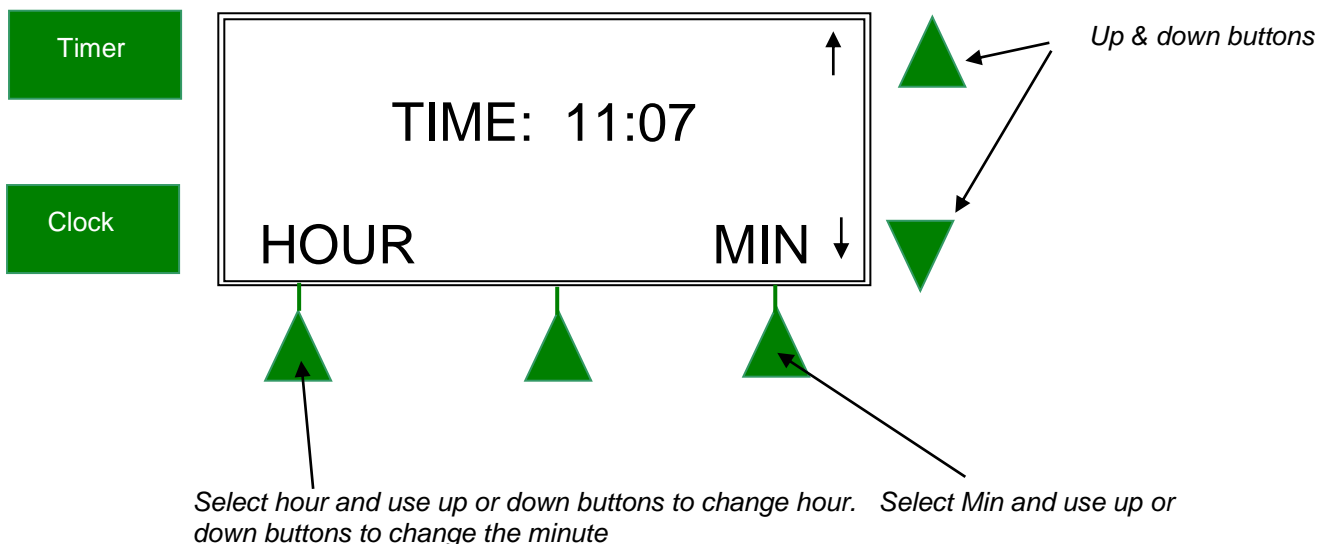

3.2 Setting Timers

Your Viron chlorinator has 4 timers per day enabling you to set different periods in which your filtration pump, pH control and chlorine production will operate. Timers are set by entering a start time, and a **RUN** time for how long you want to operate. To set timers, do the following:

- Press the **TIMER** button.
- Press **HOUR** button to set the hour for the timer selected and use the Up/Down arrows to change the time.
- Press **MIN** button to select the minutes for the timer selected and use the Up/Down arrows to change the time. Press the **NEXT** button to select the **RUN** time or another time and set as required. Note: The RUN time represents the number of hours you want the unit to operate for.
- When finished, press the **NEXT** button a number of times to scroll through the other times until you return to normal display. This saves your new settings.
- Select **Auto Sanitising** by pressing the **POOL** mode button. The **POOL** mode button has three settings, manually **ON** which turns on system indefinitely, manually **OFF** which turns system off indefinitely, and **AUTO** model which sets the controller on timer clock mode. In **AUTO** mode the LCD screen will display the date and pool sanitiser message.

3.3 Timer Recommendations:

AstralPool recommend that you use two timers, one for the morning and one for the evening and typically for periods of 2-5 hours for each. Generally, you should operate your pool for 8 hours a day in total to achieve sufficient chlorine production and circulate the pool water including skimming which will reduce debris settling in the pool and ongoing maintenance. Your Viron Series chlorinator is most effective if running in the early morning or evening when it is cooler (strong sunlight consumes more chlorine). As a default, the control is set to come on at 08:00 hours and 16:00 hours both for periods of 4 hours.

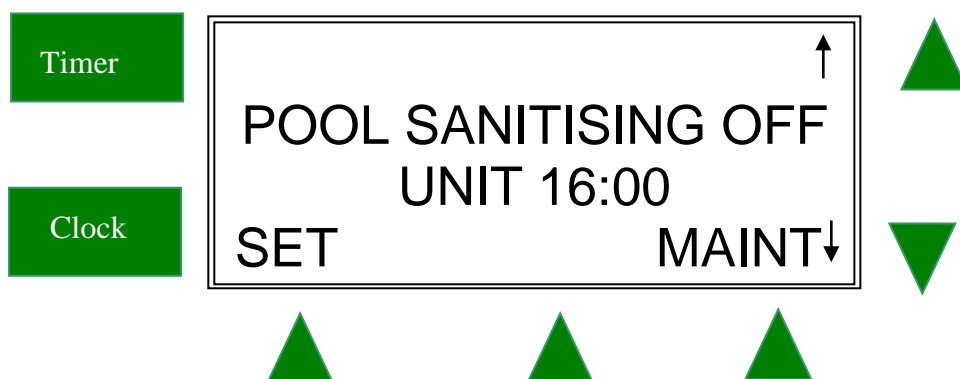

4.0 Operating Functions Accessed through Maintenance Program

Press **MAINT**

To backwash your filter press **BWASH** and then the up or down arrows to select the backwash time. You can press **ABORT** at any time to finish the back wash. To rinse the filter, you can select **BWASH** again and then select the time. Using this feature will ensure your sand filter is backwashed for the correct time. Note: Ensure pump is off when changing the position of the backwash valve on your filter. As a guide, sand filters should be backwashed for 2 to 3 minutes, and then rinsed for 1 minute.

Press **MAINT**

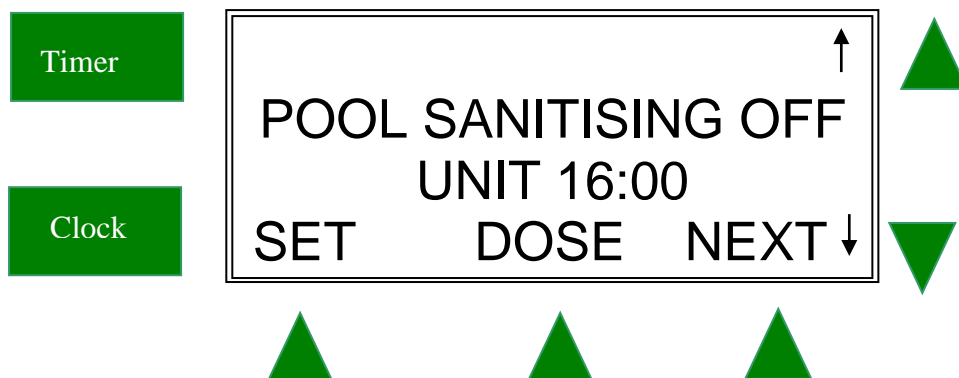

- i. Dose will allow you to override the time clock and allow the following:
 - a. Sanitise until the first timer tomorrow morning. This allows for additional circulation of the swimming pool water after treatment or cleaning. Can be used to provide a shock dose of chlorine production.
 - b. Manually prime Acid Pump. This allows for the clear PVC tube to be filled with Acid on initial start up or after changing or refilling the Acid Container. The priming period is for 300 seconds but can be stopped at any time. Should the tube not be completely filled with Acid after 300 seconds repeat the process.
 - c. Manually Dose Acid. Selecting this function allows you to manually dose acid for a predetermined time. Should your pool professional recommend the addition of Acid to your pool, select this function and press the up (or down) arrow to select the quantity of acid in litres you wish to dose. Press **ACCEPT**. The controller will then ask you what mode you wish the unit to revert to at the completion of Acid dosing, "AUTO", "ON" or "OFF". In normal circumstances you will select "AUTO" which puts the unit back into time clock operation.

- ii. **INSTALL** allows the unit to be set up for your pool or spa. This should only be selected in the initial start up of your Chlorinator. Select **INSTALL** and the following will occur:
 - a. **TIMER ENABLED** – this function will turn your timer on or off. If the chlorinator is not connected to an external timer clock or Genus Remote Control system Press **ACCEPT**. If an external timeclock is used to operate the chlorinator and filter pump then change to disabled.
 - b. **FAST COMMS** – set standard to YES, this option will only need to be changed if using a older version Hurlcon controller (no touchscreen)
 - c. **VARIABLE SPEED PUMP** – select YES if you have an AstralPool 3 speed pump. This will allow you to program the speed of the pump as part of the timer setting in the chlorinator.
 - d. **FLUSH AFTER TIMER** – select YES and your pump will come on momentarily after the timers have finished to flush any residual chemicals from the mixing cell.
 - e. **PUMP FLOW CHECK** – If active this function will monitor the flow sensor inside the chlorinator cell. If the presence of water flow is not detected for over 5 minutes, power to the pump outlet will be shut down to prevent your pump running dry.
 - f. **ENABLE LIGHT** – Your SM series chlorinator has an output to operate a single AstralPool ARC LED light.
 - g. **CELL REVERSAL PERIOD** – Standard setting is 4 hours. This should not be changed without consulting with your local AstralPool dealer or service department.
 - h. **REVERSE CELL?** – This feature can be used to perform a manual reverse of your chlorinator cell – designed for use by your pool technician only.
 - i. **SET POOL WATER VOLUME**, select **YES** and then use up or down arrows to change the volume of your pool. Press **ACCEPT**
 - j. **SET SPA WATER VOLUME**, select **YES** if your have a SPA attached to your pool and then set volume. Press **ACCEPT**
 - k. **RESET SYSTEM?** – **SELECT NO** (This option will revert your chlorinator back to factory settings. It should only be used if your SM series chlorinator enters an error that cannot be cleared)

Cycle through **POOL MODE** button to select **Auto**, **Manually ON** or **Manually OFF**.

AUTO will allow the unit to operate your filter pump, chlorine production and pH adjustment on the timer periods you have selected. If you have not changed the timer periods, the default timer turns the filter pump and unit on at 08:00 hours for a period of 4 hours and then again at 16:00 hours for a further period of 4 hours. This is the default setting from the factory.

5.0 Calibration of pH Sensor/Probe:

From time to time, the pH sensor will require cleaning and calibration. Typically, calibration should take place one every 6 to 12 months.

To Calibrate, Press MAINT and next until CAL appears on the LCD. Select CAL to commence the process.

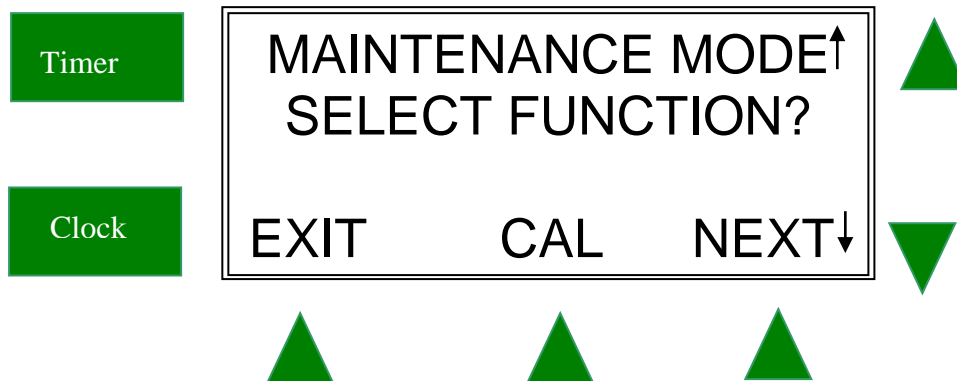

CAL

The pH probes/sensor has been factory calibrated. However it is a good practice to check the adjustment for the probe periodically (every 6 months or earlier if required). The probe should be cleaned first (refer under Maintenance page for cleaning) and allowed to settle down for about 4-5 minutes before adjusting/calibrating. The most accurate way to calibrate is to put the probe in a calibration solution. Calibration solution is available via AstralPool as a spare part.

When the controller is in Manual Off mode, remove the pH probe from the pipe line (shut off the filter pump and close any isolation valves to avoid water spill), clean the probe (see under Maintenance) and place it in a 7.5 pH Easy cal Solution (available from AstralPool). Press **MAINT** and then next until **CAL** is displayed. The unit will ask CHANGE PH CALIBRATION, select YES. Select NO to Filter Pump on?

The display will indicate that the system is measuring pH. When the pH is displayed, press the **UP** or **DOWN** buttons to get the display to indicate the same value as the buffer (7.5) and then press **ACCEPT**

6.0 OPERATION

During operation, adjustments are made by the SET button.

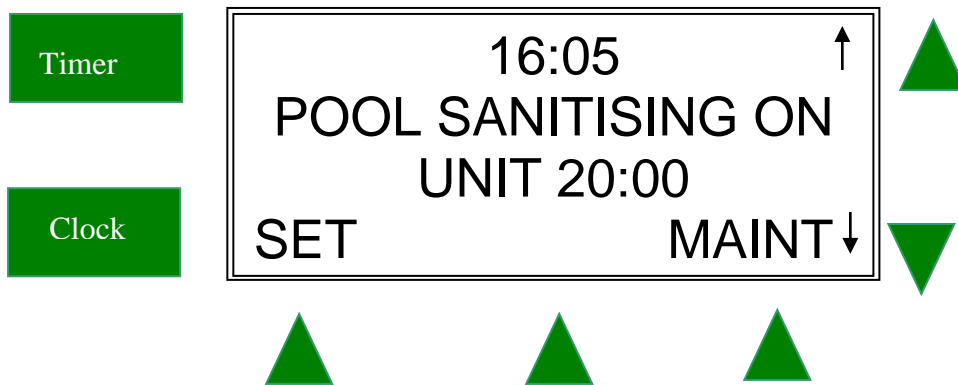

6.1 Adjusting Chlorine Output

Press the **SET** button to change the chlorine output and the pH of your Pool

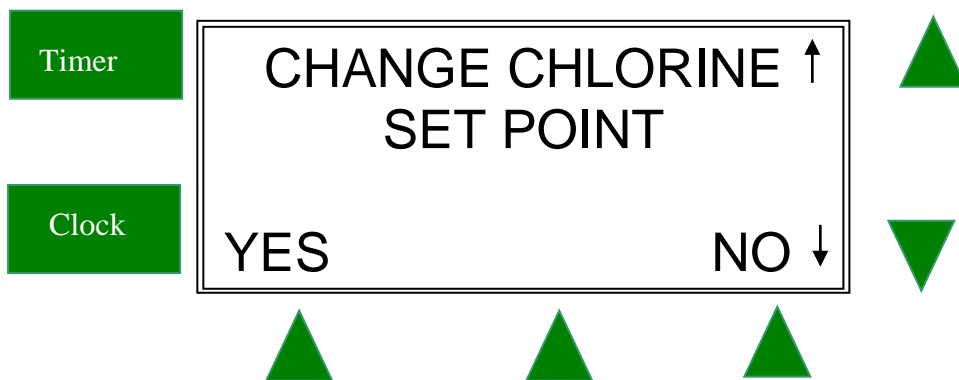

Press YES to change the output

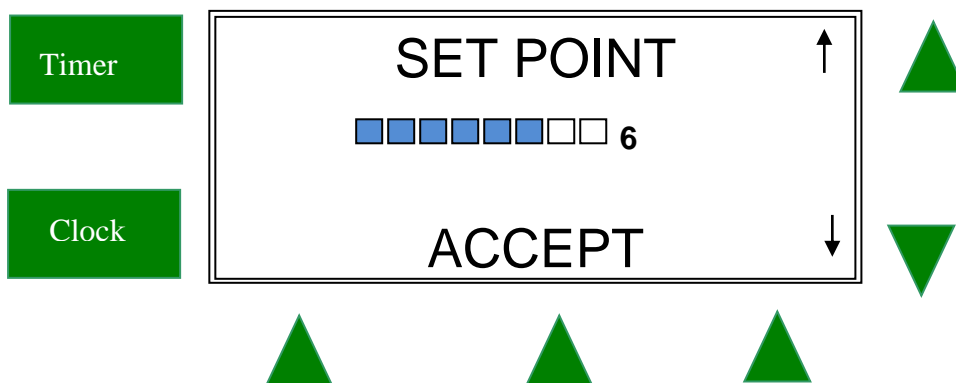

Use the up and down buttons to change the Set Point between 0 and 8. 0 chlorine output should only be used when there is no salt in the water. In summer, the chlorine should be set between 6 and 8 and you should regularly check your chlorine level in your swimming pool to determine if the output should be increased or decreased. Rely on your pool professional for advice on the recommended chlorine level in your pool.

As a guide the free chlorine level should be between 1.0 ppm and 3.0 ppm.

6.2 Adjusting pH Set Point

Continue through the **SET** menu to change the pH balance of your pool.

As a guide the pH in your pool should be set between 7.4 and 7.8. This will be determined by the type of pool you have, (Concrete, Fibreglass, Vinyl Liner) and you should rely on your pool builder or pool professional to recommend the correct pH Set Point. Use the up and down arrows to set your pH value.

6.3 Your basic Viron e-Quilibrium is supplied without any pH or Chlorine sensors. (These sensors must be ordered separately). In this format, you can determine the dosing rate of the acid by selecting 1 to 10 in the pH set screen. The unit will also intelligently adjust the dosing level according to the chlorine production (the higher the chlorine production, the faster the pH change and the more acid required). However, you **MUST** check your pH balance in the pool each day for the first week of operation and adjust the pH setting on your chlorinator until it settles at the desired pH level. Once the pH the desired pH level is achieved, continue to manually test your pH every week and adjust the pH setting as required.

Installation of the acid dosing tube – to be installed after the chlorinator cell on return to the pool

Once the pH value is set your LCD screen will return to the operating information screen which will cycle through the current status of the chlorinator and the chlorine output setting (between 0 and 8).

6.3 Installation of the pH sensor

The optional pH sensor eliminates the need to regularly test your pH balance of your pool and spa. The sensor will require checking and recalibrating approximately once every 6 months.

When installed and connected the Viron e-Quilibrium will automatically detect the pH sensor and the factory preset pH level of 7.6 will be display. You can adjust your ideal pH setting in the “settings” menu.

The pH sensor is supplied with a mixing cell that is glued into 50mm PVC pipe. Locate the Mixing Cell (diagram below) in a horizontal position with the “Locate to Top” embossing in the 12 o’clock position **BEFORE** the Chlorinator, where possible after the filter but before heaters and chlorinators.. Glue in 50mm PVC pipe into barrel unions tails or use 50 x 40mm reducers in the barrel union tails if existing plumbing is 40mm high pressure PVC pipe. Alternatively, locate the mixing cell in a vertical position after the chlorinator cell on the return side to the swimming pool. Remove rubber boot from pH sensor and screw into the mixing cell port as shown. The remaining ports in the mixing cell are blanked off using the caps and gaskets supplied as per the assembly diagram below.

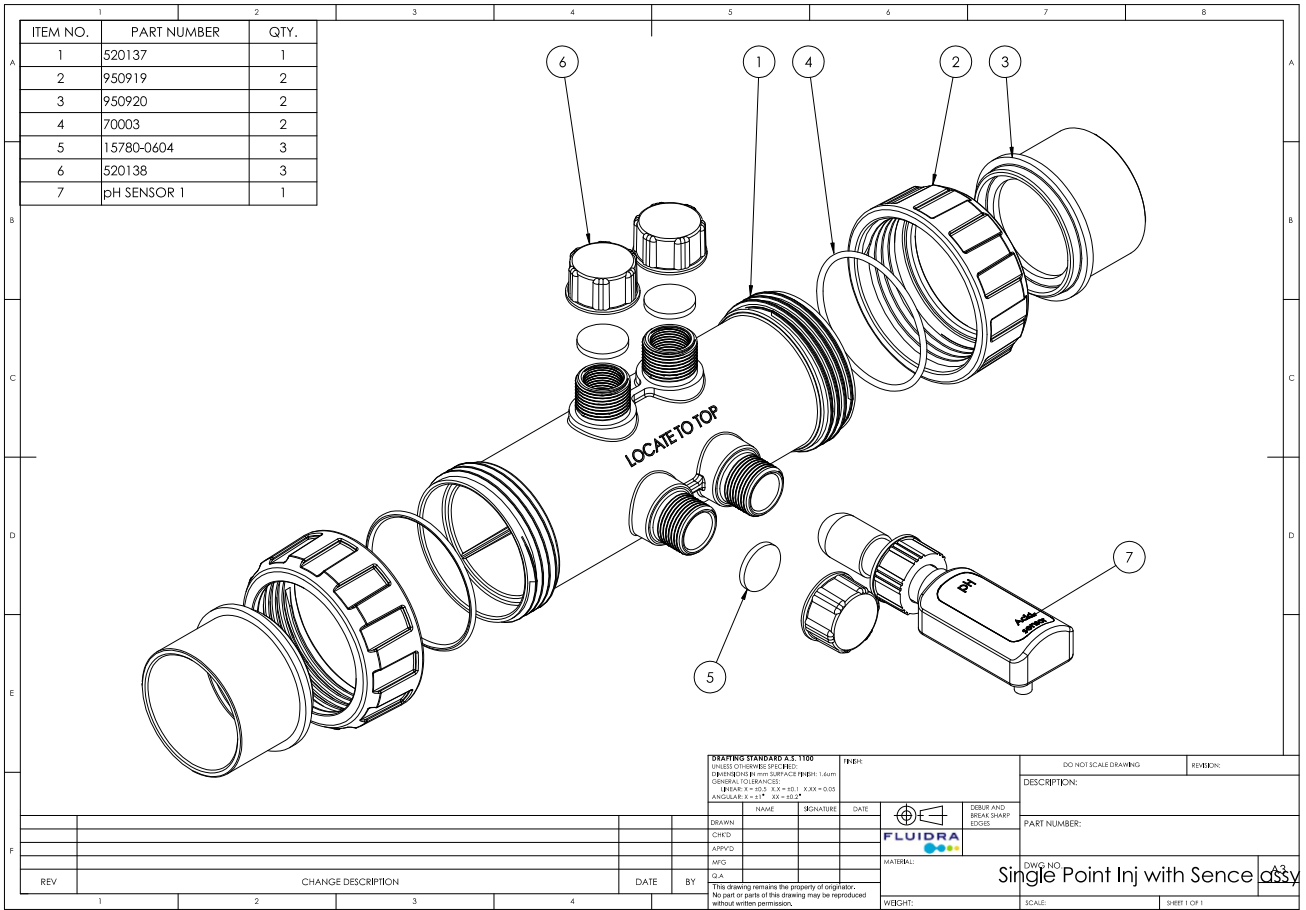

6.4 Installation of the Chlorine Sensor

If you have chosen to have the pH sensor installed, you can now choose to have the chlorine sensor installed. The chlorine sensor takes away the need to test the chlorine level in your pool and allows the Viron e-Quilbirum to automatically control the chlorine and pH levels of your pool and spa water. This option is highly recommended for pool and spa combinations, spa pools and indoor pools and spas.

The chlorine sensor is provided with a 3 metre RJ12 cable for connection to a Viron variable speed energy efficient pump. However, the chlorine sensor is simply screwed into the pH sensing chamber and connected to the bottom of the Viron e-Quilbirum controller. Once connected, the e-Quilbirum will automatically detect the sensor and the factory preset chlorine level of 700 mv will operate.

 Locate the Mixing Cell as per section 6.4 after the Chlorinator Cell. The mixing cell must have the pH sensor installed and the acid feeder tube installed. The remaining ports are blanked off using the caps and gaskets supplied.

 Assembly of the Chlorine Sensor. Remove rubber boot from sensor and screw into 50mm T piece which is glued into pipework either before filter or between filter and Chlorinator cell.



The Chlorine Sensor uses Oxidisation Reduction Potential readings to determine the chlorine level in your pool or spa water.

ORP is the most reliable and safest way to determine the level of the sanitiser in your water but is affected by other factors influencing the efficiency of the chlorine. Water pH, the use of sunscreens (cyanuric acid), Hardness and other items can all influence the reading of the ORP.

The Viron e-Quilbirum will adjust the production of chlorine to meet the ORP which MAY mean the chlorine level, when measured in simple PPM (parts per million) levels, may change from time to time. This is normal and no cause for concern. An example of higher chlorine readings when measured in ppm is if the acid runs out and is not replaced. In this case, the pH will start to increase and the effectiveness of the chlorine will reduce. As the chlorine effectiveness reduces the ORP measurement declines and the Viron e-Quilbirum will increase the power to the electrode cell to produce more chlorine. Once the pH level is corrected the Viron e-Quilbirum will reduce or turn off the power to the electrode cell as the ORP reading will rise.

When the pH and chlorine sensors are connected, the Viron e-Quilbirum LCD screen will display the additional following messages:

Chlorine Level – (chlorine low, chlorine OK, chlorine high)
Cell Was operating at (percentage of maximum output, or “off”)

pH set point (factory preset at 7.6)
pH actual (will read close to set point providing acid container has acid available to be dosed)

7.0 General Operation/Pool Chemistry

7.1 Setting the Right Chlorine Output and Filtration Time

Your Viron chlorinator must be run every day to ensure that your pool is correctly sanitised. As the sun dissipates chlorine, running times are higher in the summer compared to the winter. AstralPool recommend that you initially run your chlorinator at maximum output on level 8.

Summer

You should set your Chlorinator to operate for 8 to 10 hours per day. Ideally, run it for 4-5 hours in the morning (say 8-12pm) and 4-5 hours in the evening (say 6.00-11pm).

In extremely hot weather it may be necessary to extend the running time if you find that the free chlorine level is too low.

Winter

You should set your Chlorinator to operate for 6 to 8 hours per day. Again, running it in the morning and evening is preferable. A lower chlorine output level may be selected.

7.2 Checking Chlorine Level.

Ideally, check your Chlorine level after the morning operating period. The free chlorine residual level should be somewhere between 1 and 3 parts per million. Increase or decrease the output of the Chlorinator to get the right residual chlorine level. It may also be necessary to adjust the operating period if you are running at minimum or maximum output.

7.3 Stabiliser

AstralPool do not recommend the addition of stabiliser in a pool controlled with an eQ chlorinator with chlorine probe fitted. If Dichlor or Trichlor is used to supplement the chlorine production of the eQ chlorinator or Cyanuric Acid is added to the pool, the set point of the chlorine (ORP) should be turned down. Refer to Section 10.1 of this operating manual.

7.4 pH Level

You should keep your pH level between 7.0 and 7.4 for fibreglass pools and 7.2 to 7.8 for other pools.

7.5 Total Alkalinity

The ideal range is between 80 and 120 ppm.

7.6 Salt Level

Salt level should be maintained around 4,000ppm but should never be allowed to fall below 3,000ppm. Although salt is not consumed by the Chlorinator, salt is lost during backwashing, and when your pool overflows due to rain or splashing. The correct salt level is important to cell life and the effective operation of your chlorinator.

A typical pool of around 50,000 litres requires 200kg of salt to initially set-up the pool to 4,000ppm.

A low salt level warning is indicated on your E Series CSD Chlorinator if the salt level drops. If Low Salt is indicated, check again in 24 hours and then if it is still indicated, add two 25kg bags of salt to the shallow end of your pool. Run the filtration system for approx. 6 hours to help mix the salt in the pool. It can take up to a day for the salt to fully dissolve.

If the low salt light is still on, then you should get your pool water tested. If the Salinity is above 4000ppm then you may need to have your Chlorinator checked.

Warning: Some people recommend that you put salt directly in the skimmer box. This is a very bad practice as it allows very high concentrations of salt to be passed through your filtration and other pool equipment.

7.7 ACID Handling

Hydrochloric Acid should be handled with extreme care. Refer to Material Safety Data Sheets on Hydrochloric Acid. Do not inhale Acid fumes. Do not spill and handle with extreme care during transport. Use protective gloves and goggles.

In the case of spillage wash down with fresh water immediately. Keep out of reach of children.

8.0 Maintenance of pH and chlorine sensors and dosing tubes

8.1 Acid Pump squeeze tube

Acid pump squeeze tube must be lubricated every 6 months or more often in commercial applications. Use only the recommended lubricant RC Tube Lube available from AstralPool or any other compatible silicone lubricant, otherwise damage to the tube is possible.

Depending upon usage, the squeeze tube may need replacement after 12 months on a domestic installation, and earlier on a commercial installation. Before replacing the tube make sure that any stop valves in the filter system are closed. Otherwise water loss may occur.

(To replace the tube, remove controller draw, remove retaining screws from the pump head and pull the tube free. Disconnect the squeeze tube from the barbs and reconnect the new squeeze tube after lubricating the same, making sure that the new tube is correctly connected to the PVC tubing as per instructions. Reposition the squeeze tube in the unit as before, replace the pump head and retaining screws.) **DO NOT OVERTIGHTEN THE RETAINING SCREWS.**

8.2 Sensors:

The sensors are sensitive instruments. To maintain their accuracy they should be cleaned periodically by household detergent abrasive like Jiff. Jiff is the preferred option. The Chlorine Sensor tip can be contaminated (generally observed by a copper or brownish coating – this should always look shiny gold) which will give a false reading to the Controller causing no dosing/over dosing of chlorine. As the pH sensor tip is made of glass, please take care, for even a hair line crack can cause the sensor to read incorrectly causing malfunction.

After cleaning the sensors, wash with water, allow 5-10min. to settle and check calibration or re-calibrate if necessary. Note, the chlorine sensor may take 30 to 45 minutes to settle and provide the correct reading.

8.3 Swimming Pool Applications and the use of Cyanuric Acid

USE OF A SUN SCREEN CHEMICAL (CYANURIC ACID) FOR OUTDOOR POOLS IS RECOMMENDED. CHECK WITH YOUR LOCAL POOL SHOP AND USE THE CORRECT DOSAGE. ENSURE YOUR POOL WATER IS WELL BALANCED WITH THE CORRECT pH, TDS, TA AND STABILISER LEVELS AND FREE FROM PHOSPHATES.

9.0 Ai Mode – complete automatic control of your pool & Spa

Ai Mode is a unique Patent applied for system that controls the filtration and chlorine levels in your pool with three primary objectives:

1. Completely turnover your pool water every day so that the organic material which looks unsightly and which feeds algae and bacteria is removed from your pool.
2. Ensures the correct sanitizer level is achieved to destroy any pathogens, algae and bacteria in the water
3. Minimizes the cost of operating your pool and spa

9.1 Ai Equipment requirements

For your Viron e-Quilibrium to operate in Ai Mode you will need the following equipment:

- A Viron e-Quilibrium
- pH sensor
- chlorine sensor
- RJ12 communications cable
- Viron eVo variable speed pump

9.2 Ai Mode Connection

Connect your Viron eVo pump to the Viron e-Quilibrium with the RJ12 communications cable and plug the 3 pin plug into the bottom.

9.3 in the Viron e-Quilibrium “Set Up” screen enter “INSTALL” menu and enable the following:

- 3 speed pump enabled
- the volume of your pool and spa in litres (if no spa is installed, leave this at factory pre set level)

- select Ai Mode
- Select the size Viron Pump you have installed (1.0 hp for P320 and 2.0 for P600)
- Select the speed of the pump when you have the system manually on – we recommend speed 1 or high speed.
- Select “Continue” set up when asked.
- the number of complete water turnovers required each day, (suggest factory pre set of 1.5 times is adequate)
- When asked “Reset to Factory Defaults?” select no.
- Finally, exit the “Install Menu” and change the timer period to operate for as long as possible (suggestion of 16 hours – from 8 am to 10 pm)

9.4 Viron eVo Pump speed selection:

- Enable System mode in the Viron Pump menu – refer to Viron Pump Instructions
- Set Pump speeds as follows: Once the RJ12 Cable has connected the pump and eQ Chlorinator, change the chlorinator mode to “Manual On” to enable adjustment of the Pump Speeds. Note, once the pump is turned Manual On, it will go into Priming Mode for 5 minutes before the speeds can be changed. Alternatively, set up the pump speeds before the RJ12 connector is plugged into the chlorinator. Once the pumps speeds have been set up, ensure the SYS (system) mode is enabled in the Viron Pump Menu.
- In Ai Mode, the high speed should be set at near maximum speed of the pump.
- Medium speed should be set at a speed where the chlorinator electrode cell fills with water during operation and the skimmer box weir door creates some surface tension on near by water to skim properly. Usually, this speed will be between 1200 and 1600 RPM.
- Low speed should be selected at 600 RPM. This speed will be referred to as sampling speed. Ensure water is flowing through the chlorinator cell at this speed.

9.5 Operation in Ai Mode.

When Ai Mode is selected the Viron e-Quilibrium will operate in the following manner:

- The pump and electrode cell will start at the first time period. After the initial 5 minute priming period, the pump will revert to filter speed (medium speed), the Viron e-Quilibrium will test pH and chlorine levels and both adjust the chlorine production and dose acid to achieve the desired levels.
- The Viron e-Quilibrium will ensure the pump operates until it’s primary two objectives are achieved: (1) the Water is turned over 1.5 times (on a 50,000 litre pool, the pump will move 75,000 litres of water to ensure all of the water is filtered) and (2) the chlorine level is achieved. In the winter, this may be only 4 to 6 hours of operation. In the summer, when the pool is subject to high UV and heavy bather load it may be 12 hours as the chlorine level is constantly under demand.
- When both objectives are achieved, the Viron e-Quilibrium will turn the pump down to Sampling Speed (approx..600 RPM) which is almost inaudible and costs less than 0.5 cents per hour. During Sampling speed the Viron e-Quilibrium simply tests for chlorine levels. If the family all jump in the pool later at night and the chlorine is dissipated, the Viron e-Quilibrium will turn the pump back to filter speed (medium) and the electrode on to produce more chlorine. Your family is protected even when swimming later at night as the system is filtering and sanitising the pool or spa water automatically.
- Finally, if the correct chlorine level is NOT achieved when the system shuts down at the end of the day on time clock, it will start on maximum output and maximum pump speed the following morning until the chlorine level is achieved. Once the chlorine level is achieved, the pump will revert back to the gentle filtration speed until the required number of water turns and chlorine levels are maintained.

For further information on the set up and operation of the Viron e-Quilibrium go to Youtube on the following links:

Sensor/Probe and RJ12 Connections-	http://youtu.be/Og89iyocWFw
Install Menu Part 1 -	http://youtu.be/FPWZnp45Wyl
Setting pH & Chlorine Levels -	http://youtu.be/jQLrMCDZ9FI
Setting the Clock -	http://youtu.be/LxYU1cZqFlg
Setting Timers for Ai Mode -	http://youtu.be/ro1PA1a6zfa
Install Menu Part 2 -	http://youtu.be/AqRg2-cvrfI
Statistics Feature -	http://youtu.be/c0DfntoFTOo
Mixing Cell & Dosing Point Installation -	http://youtu.be/3eIrkH89uBE

10.0 Important Information about Chlorine Sensing by the eQuilibrium

The Viron eQuilibrium uses a ORP sensor to measure and control the chlorine levels in your swimming pool or spa.

 Before installing probes, balance pool water. Total Alkalinity (TA) must be 80 to 120 ppm, Calcium Hardness should be 180 to 250 ppm, and pH must be between 7.2 and 7.6.

 Dose pool with a small amount of chlorine before starting the eQ. If no chlorine is sensed the eQ may go to fail safe mode and not start up. Some Chlorine should be present before starting the unit.

 The Chlorine sensor will take 45 minutes or more to accurately sense the chlorine level in the pool. Allow Pool pump to run for 45 minutes before attempting to calibrate the sensor to the pool water.

Confusion often exists about the difference and relationship between oxidization reduction potential (ORP) and chlorine levels measured in parts per million (ppm).

Most pool shops and pool service technicians will focus on chlorine readings in ppm and not the ORP.

ORP is actually a more accurate and important reading than ppm because it measures the effectiveness of chlorine and NOT the level of chlorine in the water. Relying on ppm can provide a false sense of security and may even lead to use of a pool that is dangerous to swim in.

When chlorine is added to the water it reacts to form two separate chemicals, one is hypochlorous acid (HOCl) and the other is hypochloric acid (HCl). The important chemical to form is HOCl as it is the active or effective form of chlorine which oxidizes and disinfects the contaminants in the water.

The amount of HOCl and HCl formed depends on the pH of the water. The higher the pH, the less effective HOCl is formed and the more ineffective HCl is formed. Ideally, a pH range of 7.2 to 7.6 forms the most HOCl while maintaining soothing water to swim in.

At a pH of say 7.8, only 30% effective HOCl will be formed which means the chlorine is not being effective as disinfecting the pool or spa water even though the ppm is 2 or 3 ppm.

However, at a pH of 7.2, a massive 80% effective HOCl will be formed meaning the chlorine is highly effective as disinfecting the water even at levels of 1ppm.

ORP remains the best method of measure the sanitiser's (chlorine's) effectiveness in the water. At a reading of 750mv a virus kill time is as low as one second!

Various other chemicals added to the water can affect the ORP. For example, most pools will have cyanuric acid added to the water which effectively slows down the reaction of the chlorine to make it last longer. However, the slower reaction time of the chlorine lowers the ORP, hence the eQuilibrium will add more chlorine to maintain the ORP and keep your pool healthy and safe to swim in.

The important point here is that provided your chlorine sensor (ORP sensor) is checked, cleaned and calibrated every 6 months, your Viron eQuilibrium will maintain the pH and sanitizer levels for the more comfortable and healthiest swimming conditions.

10.1 Chlorine Reading and Cyanuric Acid

Cyanuric Acid (CyA) is often recommended by or added to swimming pools to make the available chlorine last longer. It is often called stabiliser or sunscreen. CYA bonds with chlorine ions which prevents the chlorine from oxidizing bacteria and other contaminants. This effectively reduces the oxidization reduction potential (ORP) of the chlorine in your pool.

Chlorine efficiency or activity is reduced even when low levels of CyA is present.

Total Alkalinity (TA) buffers pH or keeps the pH relatively stable. The pH of your pool water is crucial to making your chlorine highly effective, even when the chlorine is present in low levels. Measuring and adjusting your TA on a regular basis will help reduce acid consumption and help keep your pH level in check. Variable pH will also create variable ORP readings with high pH meaning your EQ Chlorinator will produce more chlorine to reach the set point ORP level than it would otherwise need.

CyA adds to the TA reading. If CyA levels of in excess of 50 ppm are present, it is good practice to divide the CyA by 3 and subtract the result from the TA reading. Therefore if CyA is 60, and TA is 200, subtract 20 ($60/3$) from 200 for a TA reading of 180.

CyA bonds to chlorine more effectively in sunlight hours. Therefore ORP readings will be lower in sunlight hours than at night. As the chlorine bonds with CyA during sunlight hours, the ORP may drop as more than 100 mv. This means the eQ chlorinator will drive higher levels of chlorine during sunlight hours as the chlorine is temporarily bonded with CyA. After sunset, the CyA bond with chlorine will reduce, freeing up the chlorine to oxidise with bacteria and exhibiting an increased oxidization potential reading on the eQ chlorinator.

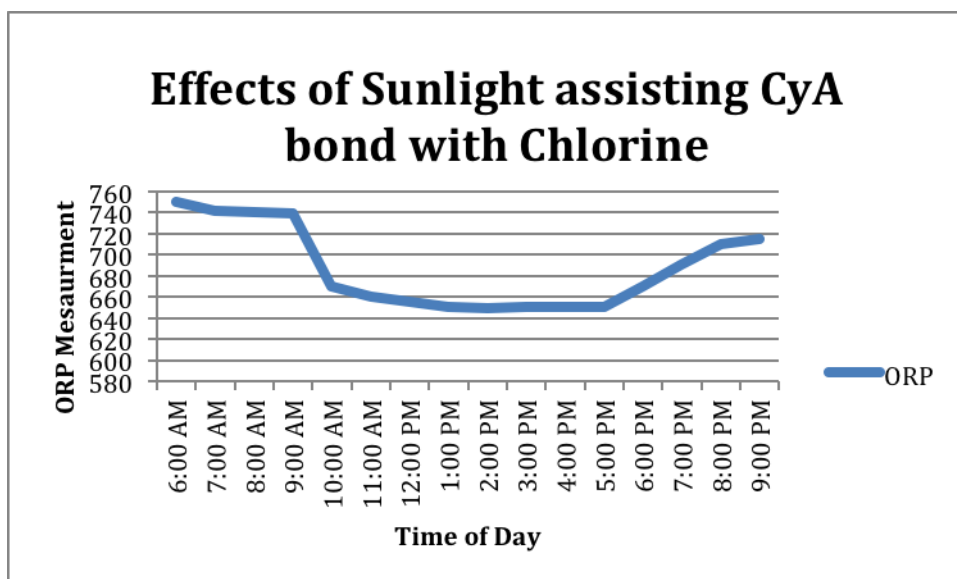
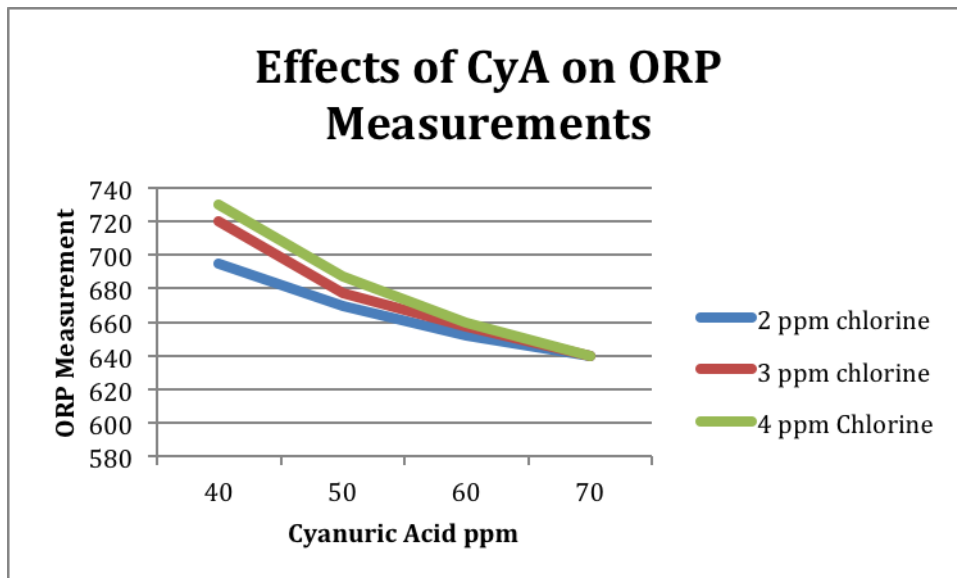

Why use CyA at all? CyA is used to extend the life of chlorine when the chlorine is manually added in the form of a tablet, granules or liquid and it is not monitored by a measuring device. This reduces the quantity and cost of Inst315 – Viron e-Equilibrium Series Chlorinator Instructions V07_14

chlorine used and maintains a residual chlorine in the pool even though manual dosing may take place every 2 or 3 days.

The AstralPool eQ Chlorinator continually monitors and produces chlorine to suit the pool's chlorine demand and costs very little to convert your pool minerals into chlorine. **AstralPool do not recommend the use of CyA in conjunction with a Salt Chlorinator that is suitably sized and incorporates a chlorine (ORP) sensing device to produce chlorine.** This includes adding CyA to the pool or supplementing the chlorinator with Dichlor or Trichlor, both of which have CyA as an active constituent. **In particular, CyA should not be used in a covered pool, indoor pool or a spa pool.**

At most, CyA should be managed and kept within a range of 10 to 20 ppm when used in conjunction with the eQ chlorinator installed with the Chlorine Sensor. Ongoing use of Trichlor or Dichlor will continue to raise the level of CyA causing a reduction in the activity of the chlorine and may cause your eQ Chlorinator to continue to raise the chlorine levels to excessive levels in order to reach the chlorine set point (ORP).

If CyA is present in the pool water or Trichlor or Dichlor is used to supplement the Chlorinator's chlorine production then the ORP set point should be adjusted downwards until a chlorine level of between 2 and 5 ppm is achieved and maintained. Consult your pool professional or certified Viron Installer to adjust your Chlorine (ORP) set point.

As a guide, the following set point ORP levels can be used as a starting point to achieve a consistent and reasonable chlorine level.

Guide to adjusting the Chlorine (ORP) set point
 Constants: pH at 7.6, TA at 180 ppm

Cyanuric Acid Level	Chlorine Level		
	2 ppm	3 ppm	4 ppm
0	700 mv	725 mv	750 mv
10	550 mv	600 mv	625 mv
20	500 mv	525 mv	550 mv
>50	350 mv	400 mv	450 mv

Check your chlorine after 48 hours and adjust the chlorine (ORP) set point up or down as necessary.

11.0 Fault Indication and trouble shooting

Fault Indication	Potential Cause	Remedy
No Flow	Pump turned off/disconnected or valves closed Sense wire disconnected from cell	Ensure valves/pump on Connect sense wire to cell
Low salt	Salt level in pool has dropped too low Pool water temperature is low Cell has failed	See section 7.5 above Increase salt level or raise water temperature Call a technician
Display blank	No Power to Controller Fuse blown	Plug in controller and ensure mains power available Call a technician
Low/No chlorine production	Cables not connected to cell Timer period too short Chlorine output level too low Filter needs backwashing Pool stabiliser too low Salt level too low Water Temperature below 15 deg Excessive Salt Level (Above 10,000 ppm) The eQ has locked out on fail safe with very low chlorine levels present (less than 100 mv ORP)	Connect cables Increase timer period Increase chlorine output Backwash filter Get Stabiliser between 30 and 60 ppm Increase salt to 4000ppm Increase water temperature or salt level Chlorinator cuts out on overload, reduce salt level to 4000 ppm Test Chlorine levels and add chlorine to pool. Start pool pump and allow one hour for sensor to read chlorine levels
Pool water cloudy	Chemical balance in incorrect Acid container empty ORP level set too low Pool water volume set too low in install menu Insufficient Water flow Insufficient water turnovers each day	Test Water and adjust as needed pH 7.2 to 7.6, TA to 120 ppm and CH to 180ppm Replace Acid Container Set ORP to 700 mv Increase pool water volume Increase variable speed of pump Increase water turns in Install menu
pH too high	Probe/sensor malfunction	Clean and Calibrate probe/sensor
Chlorine too high	ORP level is set too high Total Alkalinity too low ORP sensor is not immersed in pool water Cyanuric Acid (Chlorine Stabiliser) is present in pool	Reduce to between 650 and 700 mv ORP Test TA and adjust to 80 to 120 ppm Install sensor chamber so that it is always in pool water Lower ORP set point as in section 10.1

12.0 WARRANTY

AstralPool Australia Pty Ltd (ABN 97 007 284 504) ("AstralPool") provides the following warranty in relation to its Viron series salt chlorinator ("Product").

Our goods come with guarantees that cannot be excluded under the Australian Consumer Law. You are entitled to a replacement or refund for a major failure and for compensation for any other reasonably foreseeable loss or damage. You are also entitled to have the goods repaired or replaced if the goods fail to be of acceptable quality and the failure does not amount to a major failure.

The benefits of this warranty are in addition to any rights and remedies imposed by Australian State and Federal legislation that cannot be excluded. Nothing in this warranty is to be interpreted as excluding, restricting or modifying any State or Federal legislation applicable to the supply of goods and services which cannot be excluded, restricted or modified.

WARRANTY

AstralPool warrants that, subject to the exclusions and limitations below, the Product will be free from defects in materials and workmanship during the warranty period. The warranty periods are set out below and commence 30 days after the date of purchase (to allow for installation). The warranty period may vary for different parts of the Product.

Parts	Warranty Period
Control box including PCB's	5 years pro rata 0% payable of invoice total year 1 20% payable of invoice total year 2 40% payable of invoice total year 3 60% payable of invoice total year 4 80% payable of invoice total year 5
pH and chlorine Sensors, dosing motor/gearbox and associated tubing/fittings	12 months
Chlorinator cell electrode	5 years

If a defect appears in the Product before the end of the warranty period and AstralPool finds the Product to be defective in materials or workmanship, AstralPool will, in its sole discretion, either:

- (a) replace or repair the Product or the defective part of the Product free of charge; or
- (b) Cause the Product or the defective part of the Product to be replaced or repaired by an Authorised AstralPool Service Agent free of charge.

AstralPool reserves the right to replace defective parts of the Product with parts and components of similar quality, grade and composition where an identical part or component is not available.

Goods presented for repair may be replaced by refurbished goods of the same type rather than being repaired. Refurbished parts may be used to repair the goods.

WARRANTY CLAIMS

1. If a fault covered by warranty occurs, the customer must first contact AstralPool at the contact address listed below, or an Authorised AstralPool Service Agent.
2. Any warranty claim must be accompanied by:
 - (a) proof of purchase;
 - (b) full details of the alleged defect; and
 - (c) appropriate documentation (such as historical and maintenance records).

3. The customer must make the Product available to AstralPool or its Authorised AstralPool Service Agent for inspection and testing. AstralPool or its Authorised AstralPool Service Agent will attend the premises where the Product is installed for inspection and testing. If the Product is installed:

- (a) outside a capital city metropolitan area; and
- (b) is not within a 20 km radius of an Authorised AstralPool Service Agent;

then the customer may have to pay a travel fee.

4. If such inspection and testing finds no defect in the Product, the customer must pay AstralPool's usual costs of service work and testing. If such inspection and testing finds a defect that is not covered by this warranty, the customer must pay AstralPool's usual costs of service work plus any parts and labour required to repair the Product, unless recoverable from AstralPool on the failure of any statutory guarantee under the ACL.

Exclusions

The warranty will not apply where:

- (a) the customer is in breach of the Terms and Conditions of Sale;
- (b) the Product was used for a purpose other than one it was intended for;
- (c) the Product was repaired, modified or altered by any person other than AstralPool;
- (d) the Product has not been installed, maintained and/or operated in complete compliance with the installation and operating instructions and any instructions by AstralPool;
- (e) the Product has been subject to accident, negligence, alteration, abuse or misuse.

The warranty does not extend to:

- a) normal wear and tear;
- b) weather and other environmental conditions including but not limited to storm, flood, and/or heat wave damage; or
- c) service and maintenance items.

Examples of exclusions include but are not limited to:

- cleaning and calibration of probes

Commercial Installations

On commercial installations, such as health clubs, motels/hotels and hydrotherapy facilities, the warranty is limited to parts and in field labour (within capital city metropolitan areas or 20 km radius of Authorised AstralPool Service Agents) for a period of 12 months from the date of purchase plus 30 days to allow for installation.

LIMITATIONS

AstralPool makes no express warranties or representations other than set out in this warranty.

The repair or replacement of the Product or part of the Product is the absolute limit of AstralPool's liability under this express warranty.



INST315



Melbourne
39-45 Cyber Loop
Dandenong VIC 3175
P: 03 8796 8600

Townsville
17 Auscan Crescent
Garbutt QLD 4814
P: 07 4796 0100

Sydney Seven Hills
2/2 Welder Road
Seven Hills NSW 2147
P: 02 9853 2100

Sydney Moorebank
6/30 Heathcote Road
Moorebank NSW 2170
P: 02 8778 9500

Adelaide
13 William Street
Mile End South SA 5031
P: 08 8152 7600

Brisbane
1/27 Millenium Place
Tingalpa QLD 4173
P: 07 3308 5400

Perth
97 Sheffield Road
Welshpool WA 6106
P: 08 9350 2600

Gold Coast
1/28 Export Drive
Molendinar QLD 4214
P: 07 5552 2600

sales@astralpool.com.au
www.astralpool.com.au