

# WAGNER®

PAINT FAST. PAINT SMART.

# Paint Crew®

Superior House Painting Tool™  
Airless Paint Sprayer  
**MODEL 770**

**Owner's manual:** Read this manual for complete instructions  
**Guide d'utilisation :** Ce manuel contient des instructions détaillées  
**Manual del propietario:** Le este manual para obtener instrucciones completas

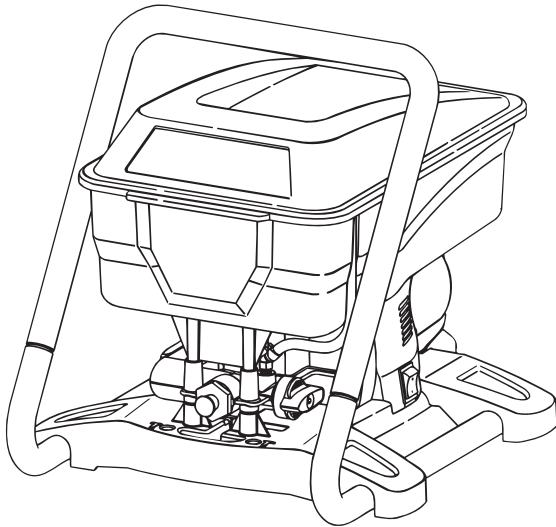

## English - Table of Contents

Safety Information	2-3
Components and Assembly	4
Before you Begin	5
Purging and Priming	6
Spraying	7
Spraying Troubleshooting	8
Cleanup	9-10
Inlet / Outlet Valves	10
Storage	11
Troubleshooting	12
Maintenance	12
Parts List	37
Warranty	44

**Technical service hours:** Monday through Friday, 8:00 am to 4:30 Central Time

## Français - Table des matières

Sécurité	14-15
Composants y assemblage	16
Avant de commencer	17
Purge et amorçage	18
Pulvérisation	19
Problèmes potentiels	20
Nettoyage	21-22
Soupapes d'entree / de sortie	22
Rangement	23
Dépannage	24
Entretien	24
Liste de pièces	37
Garantie	44

**Heures d'ouverture du Service Technique:**  
du lundi au vendredi, de 8 h à 16:30 h, heure normale du Centre

## Español - Tabla de Contenido

Información de seguridad	26-27
Componentes y ensamblaje	28
Antes de comenzar	29
Purga y cebado	30
Rociadora	31
Solución de problemas de rociadora	32
Limpieza	33-34
Válvulas de entrada / salida	34
Almacenamiento	35
Solución de problemas	36
Mantenimiento	36
Lista de piezas	37
Garantía	44

**Horario del servicio técnico:**  
De lunes a viernes, de 8 a.m. a 4:30 p.m., Hora Central



**1-800-328-8251**

**Wagner Technical Service**  
Or visit us on the world wide web!

Ou visitez notre site Web!

¡O visitenos en Internet!

<http://www.wagnerspraytech.com>

### Need Help?

Call us first for answers fast. Call Wagner toll-free if you have any comments or problems with this Wagner product.

### Besoin d'aide?

Appelez-nous pour des réponses rapides. Téléphonnez à Wagner sans frais d'appel si vous avez des commentaires ou des problèmes avec l'appareil.

### ¿Necesita Ayuda?

Llámenos primero para obtener respuestas rápidas. Llame a la línea gratuita de Wagner si quiere hacer un comentario o tiene problemas con este producto de Wagner.



# Important Safety Information • Read all safety information before operating the equipment. Save these instructions

To reduce the risks of fire or explosion, electrical shock and the injury to persons, read and understand all instructions included in this manual. Be familiar with the controls and proper usage of the equipment.

 Indicates a hazardous situation which, if not avoided, could result in death or serious injury.

## HAZARD: INJECTION INJURY

A high pressure paint stream produced by this equipment can pierce the skin and underlying tissues, leading to serious injury and possible amputation. SEE A PHYSICIAN IMMEDIATELY.



**DO NOT TREAT AN INJECTION INJURY AS A SIMPLE CUT!** Injection can lead to amputation. See a physician immediately. The maximum operating range of the gun is 2800 PSI/193 BAR fluid pressure.

### PREVENTION:

- NEVER aim the gun at any part of the body.
- Do not aim the gun at, or spray any person or animal.
- NEVER allow any part of the body to touch the fluid stream. DO NOT allow body to touch a leak in the fluid hose.
- NEVER put your hand in front of the gun. Gloves will not provide protection against an injection injury.
- ALWAYS lock the gun trigger, shut the pump off, and release all pressure before servicing, cleaning the tip or guard, changing tip, or leaving unattended. Pressure will not be released by turning off the motor. The PRIME/SPRAY knob must be turned to PRIME to relieve the pressure. Refer to the [Pressure Relief Procedure](#) described in the pump manual.
- ALWAYS keep the tip guard in place while spraying. The tip guard provides some protection but is mainly a warning device.
- ALWAYS remove the spray tip before flushing or cleaning the system.
- Paint hose can develop leaks from wear, kinking and abuse. A leak can inject material into the skin. Inspect the hose before each use. Do not use hose to lift or pull equipment.
- NEVER use a spray gun without a working trigger lock and trigger guard in place.
- All accessories must be rated at or above 2800 PSI/193 BAR. This includes spray tips, guns, extensions, and hose.

### NOTE TO PHYSICIAN:

Injection into the skin is a traumatic injury. It is important to treat the injury as soon as possible. DO NOT delay treatment to research toxicity. Toxicity is a concern with some coatings injected directly into the blood stream. Consultation with a plastic surgeon or reconstructive hand surgeon may be advisable.

## HAZARD: HAZARDOUS VAPORS

Paints, solvents, insecticides, and other materials can be harmful if inhaled or come in contact with the body. Vapors can cause severe nausea, fainting, or poisoning.



### PREVENTION:

- Use a respirator or mask if vapors can be inhaled. Read all instructions supplied with the mask to be sure it will provide the necessary protection.
- Wear protective eyewear.
- Wear protective clothing as required by coating manufacturer.



## HAZARD: EXPLOSION OR FIRE

Solvent and paint fumes can explode or ignite. Property damage and/or severe injury can occur.



### PREVENTION:

- Provide extensive exhaust and fresh air introduction to keep the air within the spray area free from accumulation of flammable vapors. Solvent and paint fumes can explode or ignite.
- Do not spray in a confined area.
- Avoid all ignition sources such as static electric sparks, open flames, pilot lights, electrical appliances, and hot objects. Connecting or disconnecting power cords or working light switches can make sparks. Paint or solvent flowing through the equipment is able to result in static electricity.
- Do not smoke in spray area.
- Fire extinguisher must be present and in good working order.
- Place paint pump in a well-ventilated area away from the spray object. Flammable vapors are often heavier than air. Floor area must be extremely well ventilated.
- The equipment and objects in and around the spray area must be properly grounded to prevent static sparks.
- Keep area clean and free of paint or solvent containers, rags and other flammable materials.
- Use only conductive or grounded high pressure fluid hose. Gun must be grounded through hose connections.
- Power cord must be connected to a grounded circuit.
- Always flush unit into a separate metal container with spray tip removed. Hold gun firmly against side of container to ground container and prevent static sparks.
- Follow the material and solvent manufacturer's warnings and instructions. Know the contents of the paints and solvents being sprayed. Read all Material Safety Data Sheets (MSDS) and container labels provided with the paints and solvents. Follow the paint and solvent manufacturer's safety instructions.
- This product may be used only with water-based materials or materials with a minimum flash point of 70°F (21°C) for spraying or cleaning. Do not spray or clean with materials having a flash point less than 70°F (21°C), such as solvent based lacquers, enamels, and/or stain blockers. Flash point is the temperature at which a fluid can produce enough vapors to ignite.
- Plastic can cause static sparks. Never hang plastic to enclose a spray area. Do not use plastic drop cloths when spraying flammable materials.
- Do not spray onto pump assembly.



## HAZARD: EXPLOSION HAZARD DUE TO INCOMPATIBLE MATERIALS

Will cause property damage or severe injury.



### PREVENTION:

- Do not use materials containing bleach or chlorine.
- Do not use halogenated hydrocarbon solvents such as bleach, mildewcide, methylene chloride and 1,1,1 - trichloroethane. They are not compatible with aluminum.
- Contact your coating supplier about the compatibility of material with aluminum.



# Important Safety Information • Read all safety information before operating the equipment. Save these instructions

## HAZARD: GENERAL

Can cause severe injury or property damage.

### PREVENTION:

- Read all instructions and safety precautions before operating equipment.
- Follow all appropriate local, state, and national codes governing ventilation, fire prevention, and operation.
- The United States Government Safety Standards have been adopted under the Occupational Safety and Health Act (OSHA). These standards, particularly part 1910 of the General Standards and part 1926 of the Construction Standards should be consulted.
- Use only manufacturer authorized parts. User assumes all risks and liabilities when using parts that do not meet the minimum specifications and safety requirements of the pump manufacturer.
- Before each use, check all hoses for cuts, leaks, abrasion or bulging of cover. Check for damage or movement of couplings. Immediately replace the hose if any of these conditions exist. Never repair a paint hose. Replace it with another grounded high-pressure hose.
- All hoses and fittings must be secured before operating spray pump. Unsecured parts can eject at great force or leak a high pressure fluid stream causing severe injury.
- All hoses, swivels, guns, and accessories must be pressure rated at or above 2800 PSI/193 BAR.
- Do not spray outdoors on windy days.
- Wear clothing to keep paint off skin and hair.
- Do not operate or spray near children. Keep children away from the equipment at all times.
- Do not overreach or stand on an unstable support. Keep effective footing and balance at all times.
- Stay alert and watch what you are doing.
- Do not operate the unit when fatigued or under the influence of drugs or alcohol.

## Important Electrical Information

### NOTICE

Use only a 3-wire extension cord that has a 3-blade grounding plug and a 3-slot receptacle that will accept the plug on the product. Make sure your extension cord is in good condition. When using an extension cord, be sure to use one heavy enough to carry the current your product will draw. An undersized cord will cause a drop in line voltage resulting in loss of power and overheating. A 14 or 12 gauge cord is recommended (see chart below). If an extension cord is to be used outdoors, it must be marked with the suffix W-A after the cord type designation. For example, a designation of SJTW-A would indicate that the cord would be appropriate for outdoor use.

Wagner Spray Tech accessory extension cords recommended:

- P/N 0090241 20 foot extension cord.
- P/N 0090242 35 foot extension cord.

Cord gauge	Maximum cord length
12	150 feet
14	100 feet

**Do not use more than 50 feet of spray hose. If you need to spray further than 50 feet from your power source, use more extension cord, not more spray hose.**

## Grounding Instructions

This product must be grounded. In the event of an electrical short circuit, grounding reduces the risk of electric shock by providing an escape wire for the electric current. This product is equipped with a cord having a grounding wire with an appropriate grounding plug. The plug must be plugged into an outlet that is properly installed and grounded in accordance with all local codes and ordinances.



**Improper installation of the grounding plug can result in a risk of electric shock.**



If repair or replacement of the cord or plug is necessary, do not connect the green grounding wire to either flat blade terminal. The wire with insulation having a green outer surface with or without yellow stripes is the grounding wire and must be connected to the grounding pin.

Check with a qualified electrician or serviceman if the grounding instructions are not completely understood, or if you are in doubt as to whether the product is properly grounded. Do not modify the plug provided. If the plug will not fit the outlet, have the proper outlet installed by a qualified electrician.

This product is for use on a nominal 120 volt circuit and has a grounding plug that looks like the plug illustrated below. Make sure that the product is connected to an outlet having the same configuration as the plug. **No adapter should be used with this product.**

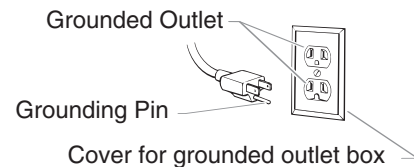

**Do not expose motor to solvents or water.**



**If you experience problems with your sprayer at any time during assembly, operation, or cleanup, please refer to the [Troubleshooting](#) section of this manual (page 12), or call customer service at:**

**1-800-328-8251**

# Components and Assembly

## Specifications

- Weight**.....25 lbs.
- Capacity** .....2 gallon hopper
- Power source**.....3/8 Hp universal motor
- Power requirement**.....15 amp minimum circuit on 120 VAC, 60 Hz current.
- Generator** .....8000 Watt.
- Max. spraying pressure** ...2800 PSI
- Safety features:** Spray gun trigger lock and pressure diffuser; built-in tip safety guard; PRIME/SPRAY knob for safe pressure release. **Conforms to UL STD 1450. Certified to CAN/CSA C 22.2 NO 68-92.**
- Capability:** Sprays a variety of paints, latex, primers, stains, preservatives and other nonabrasive materials, including pesticides and liquid fertilizers. **Do not use materials with flash points below 70°F (21°C).**

## Controls and Functions

- ON/OFF Switch:**  
The ON/OFF switch turns the power to the sprayer on and off (O=OFF, I=ON).
- Spray Gun:**  
The spray gun controls the delivery of the fluid being pumped.
- Spray Hose:**  
The spray hose connects the gun to the pump.
- Return Tube:**  
Fluid is sent back out through the return tube to the original container when PRIME/SPRAY knob is in PRIME position.
- PRIME/SPRAY Knob:**  
The PRIME/SPRAY knob directs fluid to the spray hose when set to SPRAY or the return tube when set to PRIME. The PRIME/SPRAY knob is also used to relieve pressure built up in the spray hose (see [Pressure Relief Procedure](#), page 5).

This pump should not be used with textured materials, block filler, lacquers, industrial enamels, or asphalt sealer or materials containing HHC. See coating supplier if flash point is not listed on the container.

## Components / Assembly

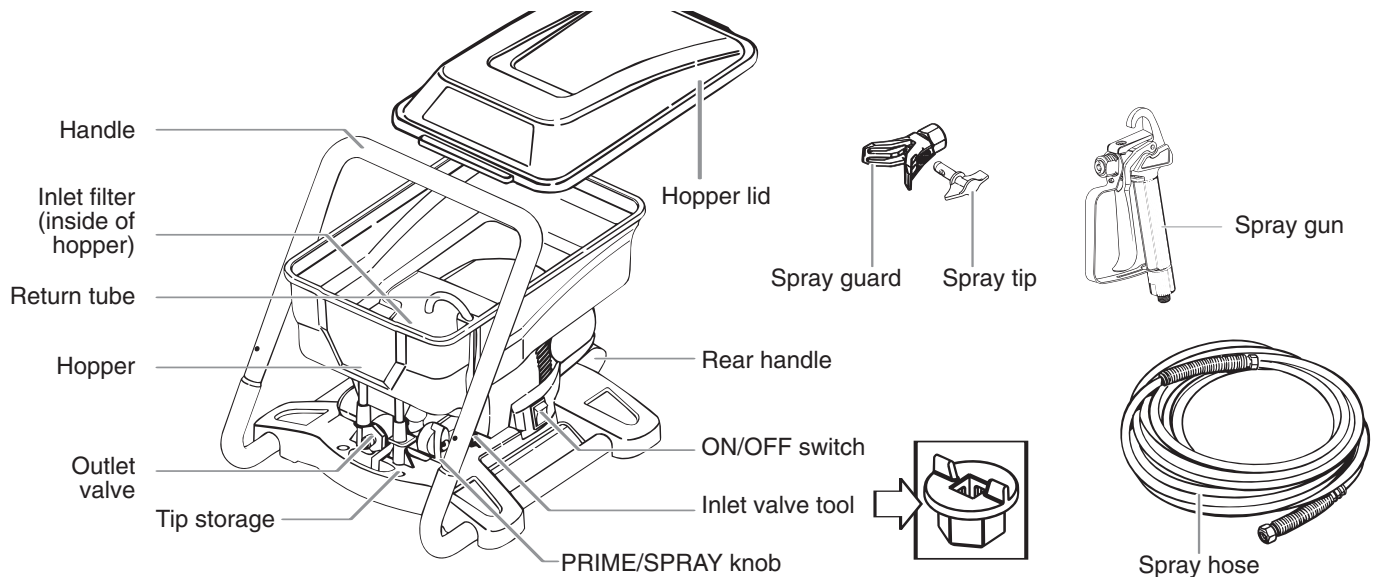

**⚠ Do not plug in the unit until setup is complete.**

1. Place the handle over the unit frame. Insert the bolts and tighten the wing nuts over the lock washers.

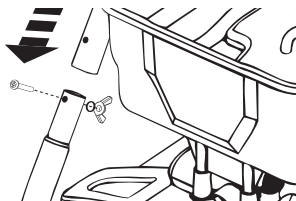

2. Thread one end of the high pressure spray hose to the outlet valve. Tighten with an adjustable wrench.

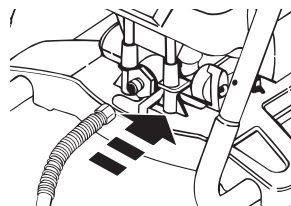

3. Thread the other end of the hose to the spray gun. Hold the gun with one adjustable wrench, and tighten the hose nut with the other.

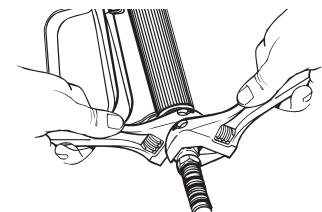

# Before You Begin - This section contains instructions that will be repeated throughout this manual.

## Locking and Unlocking the Spray Gun:

**!** Always lock the trigger off when attaching the spray tip or when the spray gun is not in use.

### Locking the Spray Gun

The gun is secured when the trigger lock is at a 90° angle (perpendicular) to the trigger in either direction.

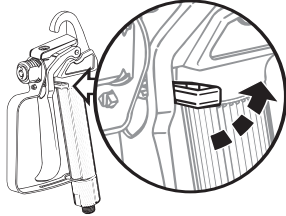

### Unlocking the Spray Gun

To unlock the gun, turn the trigger lock to be in line with the trigger.

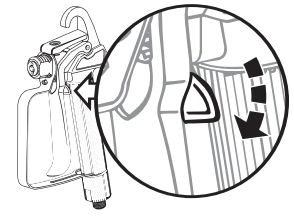

## Pressure Relief Procedure:

**!** Be sure to follow the Pressure Relief Procedure when shutting the unit off for any purpose. This procedure is used to relieve pressure from the spray hose.

1. Lock the spray gun off ([see directions above](#)). Flip the ON/OFF switch to the OFF position.

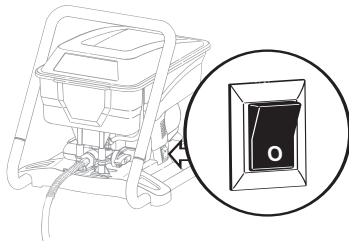

2. Turn the PRIME/SPRAY knob to PRIME.

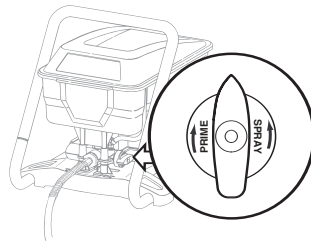

3. Unlock the spray gun and trigger spray gun into the side of the material bucket. Lock the spray gun.

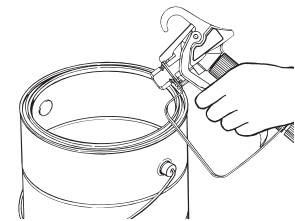

## Emptying the Hopper:

**NOTE -** Follow these instructions if the hopper is filled with material and you finish your spraying project without using all the material in the hopper.

1. Perform [Pressure Relief Procedure](#) (see above).
2. Remove the lid from the hopper.
3. Grab top handle of the sprayer with one hand, grab rear handle with the other.
4. Lift and tilt the sprayer so that material will pour from one of the front corners of the hopper and into its original container.

**!** The unit, when filled with spraying material, can be heavy. Make sure to lift with your legs and not your back in order to reduce the risk of injury.

**NOTE -** Make sure your floors and furnishings are protected with drop cloths to avoid property damage.

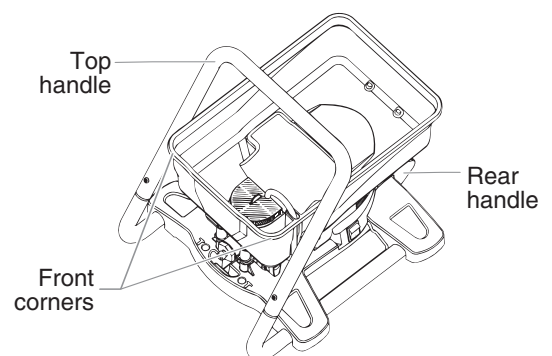



# Purging and Priming

1. Make sure the inlet filter is in place inside the hopper. If it is not, snap in place as shown. Push the tab (a) on top of the filter down once. This will ensure proper operation of the inlet valve.

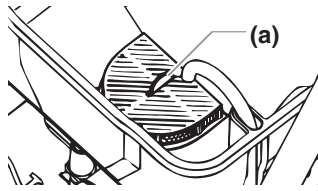

2. Pull the return tube from the hopper and hold it over a waste container.

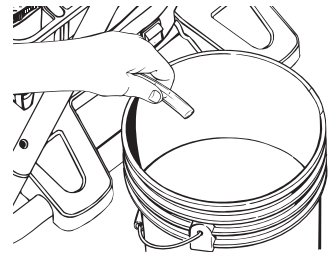

3. Turn the PRIME/SPRAY knob to PRIME. Plug in the sprayer. Turn the ON/OFF switch to ON (I).

**Any fluids remaining in the pump and the return tube will flow out of the return tube. Let the pump run until no fluid is coming from the return tube.**

4. Switch the pump to OFF. Remove the return tube from the waste container and secure it to the hopper.

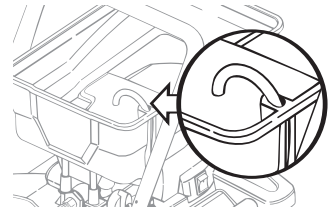

5. Fill your hopper with the material you plan to spray. Do not exceed the fill line (b) as shown. Replace hopper lid.

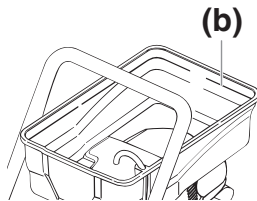

6. Leave the PRIME/SPRAY knob on PRIME. Switch your unit ON once more and make sure that material is flowing from the return tube. Turn pump OFF (O).

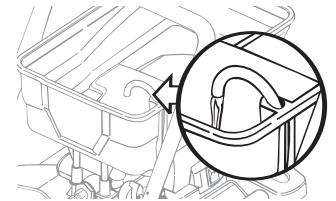

7. Unlock the spray gun. **PULL** the trigger and aim the spray gun at the side wall of a waste container. **The spray tip SHOULD NOT be attached to the spray gun.**

**If using oil-based materials, the spray gun must be grounded while purging (see warning below).**

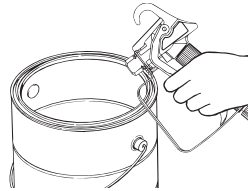

8. While pulling the trigger, switch the pump ON (I), **AND** turn the PRIME/SPRAY knob to SPRAY. **Hold the trigger until all air, water, or solvent is purged from the spray hose and material is flowing freely.**

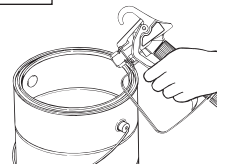
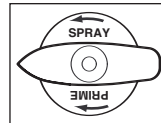

**Keep hands clear from fluid stream.**

**Ground the gun by holding it against the edge of a metal container while flushing. Failure to do so may lead to a static electric discharge which may cause a fire.**

**If the PRIME/SPRAY knob is still on SPRAY, there will be high pressure in the hose and spray gun until the PRIME/SPRAY knob is turned to PRIME.**

9. Release trigger. Turn the PRIME/SPRAY knob to PRIME. Turn the pump OFF (O).

**Trigger the gun into the waste container to be sure that no pressure is left in the hose.**

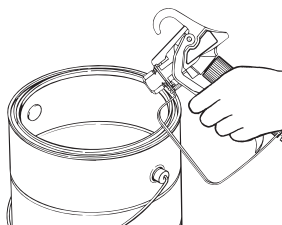

10. Lock the spray gun off. Thread the spray tip guard assembly onto the gun. Tighten by hand.

Begin tightening the tip at this angle

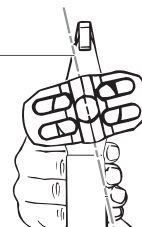

to achieve the desired spray angle when tight.

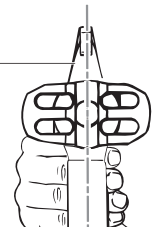

# Practice / Spraying Technique

**NOTE - Be sure that the paint hose is free of kinks and clear of objects with sharp cutting edges.**

1. Switch the pump ON (I). Turn the PRIME/SPRAY knob to SPRAY.

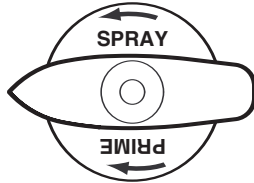
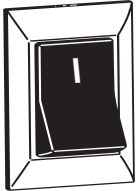

2. When motor shuts off, unlock the spray gun and spray a test area to check the spray pattern.

**The motor will cycle on and off automatically as it needs pressure.**

Good spray pattern



Paint tailing pattern  
(pressure too low, clogged tip)



**The key to a good job is an even coating over the entire surface. This is done by using even strokes. Follow the TIPS, below.**

**Tip:** Keep the spray gun at right angles to the surface. This means moving your entire arm back and forth rather than just flexing your wrist.

Light Coat    Heavy Coat    Light Coat

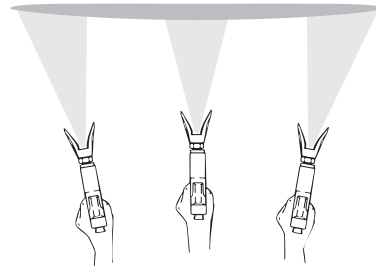

**Tip:** Keep the spray gun perpendicular to the surface, otherwise one end of the pattern will be thicker than the other.

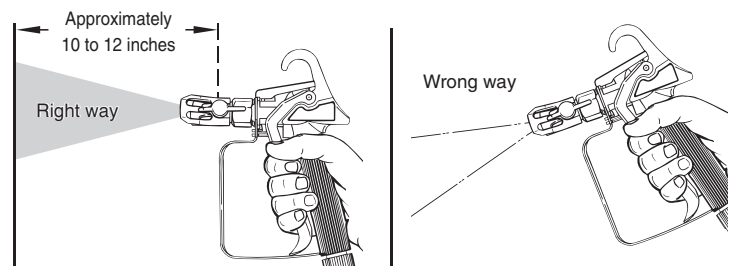

**Tip:** Trigger gun after starting the stroke. Release the trigger before ending the stroke. The spray gun should be moving when the trigger is pulled and released. **Overlap each stroke by about 30%. This will ensure an even coating.**

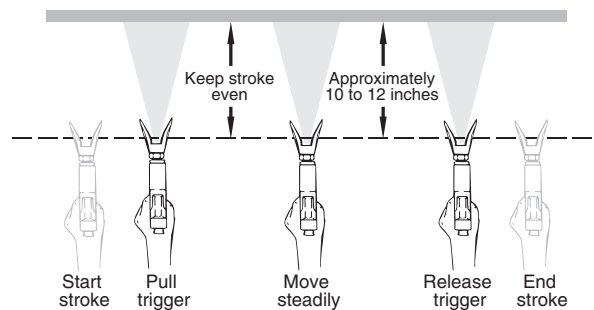

If you expect to be away from your sprayer for more than one hour, follow the [Short-Term Storage](#) instructions (page 11).

# Spraying Troubleshooting -

Follow these steps if your spray pattern becomes distorted or stops completely.

## Unclogging the Spray Tip

**!** Do not attempt to unclog or clean the tip with your finger.

**NOTE -** Do not use a needle or other sharp pointed instrument to clean the tip. The hard tungsten carbide can chip.

If the spray pattern becomes distorted or stops completely while the gun is triggered, follow these steps.

1. Release the trigger and lock the gun off (see page 5). Rotate the reversible tip arrow 180° so that the point of the arrow is toward the rear of the gun (CLEAN position).

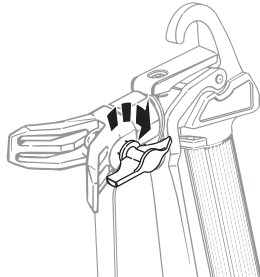

**Under pressure, the spray tip may be very difficult to turn. Turn the PRIME/SPRAY knob to PRIME and trigger the gun. This will relieve pressure and the tip will turn more easily.**

2. Turn the PRIME/SPRAY knob to SPRAY.
3. Unlock the gun and squeeze the trigger, pointing the gun at a scrap piece of wood or cardboard. This allows pressure in the spray hose to blow out the obstruction. When the nozzle is clean, material will come out in a straight, high pressure stream.

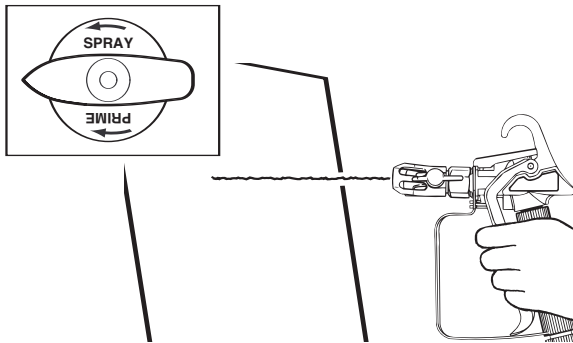

If material still will not spray from the spray tip, follow the steps in the next column.

4. Release the trigger and lock the gun off (see page 5). Reverse the tip so the arrow points forward again (SPRAY position). Unlock the gun and resume spraying.

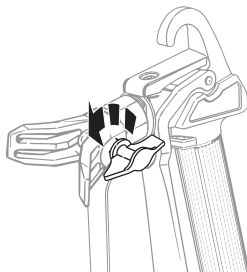

## Cleaning the Spray Gun Filter

The filter must be cleaned every time you use your sprayer. When using thicker spray materials, the filter might need to be cleaned more often.

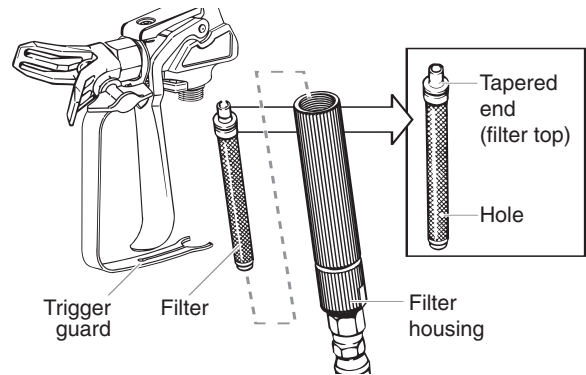

1. Perform [Pressure Relief Procedure](#), page 5.
2. Unclip the trigger guard from the filter housing by pulling outward from the filter housing. Unscrew the filter housing.
3. Remove the filter from the spray gun housing and clean with the appropriate cleaning solution (warm, soapy water for latex paints, mineral spirits for oil-based materials).
4. Inspect the filter for holes (see inset). Replace if holes are found.

**NOTE - NEVER POKE THE FILTER WITH A SHARP INSTRUMENT!**

5. Replace the cleaned filter, tapered end first, into the gun housing. **The tapered end of the filter must be loaded properly into the gun. Improper assembly will result in a plugged tip or no flow from the gun.**
6. Reassemble the spray gun.

## Unclogging the Inlet Filter

1. Perform [Pressure Relief Procedure](#), page 5.
2. Empty the hopper of all spraying material (see [Emptying the Hopper](#), page 5).
3. Remove the inlet filter (a) from the hopper. You may need to use a screwdriver to pry the filter loose.
4. Clean the inlet filter using the appropriate cleaning solution (warm, soapy water with latex paints, mineral spirits with oil-based paints or stains).
5. Replace filter.

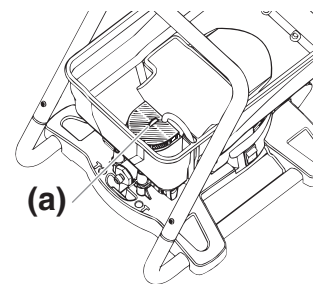

If after having completed all of the steps on this page you are still experiencing problems spraying, refer to the [Troubleshooting](#) page (page 12).



# Cleanup

## Important Cleaning Notes - Read before cleaning

- When using latex materials, clean your sprayer and components with water. When using oil-based materials, use mineral spirits. **DO NOT** use gasoline to clean your sprayer.
- Do not use mineral spirits on latex materials, or the mixture will turn into a jelly-like substance which is difficult to remove.
- No matter which cleaning solution you use, make sure to dispose of it properly when finished cleaning your sprayer.
- Thorough cleaning and lubrication of the sprayer is the most important step you can take to ensure proper operation after storage.

 Never use a garden hose near unit. Motor and ground near sprayer must remain dry.

 Follow these steps whenever cleaning with mineral spirits:

- Always flush spray gun at least one hose length away from spray pump.
- If collecting flushed solvents in one gallon metal container, place it into an empty five gallon container, then flush.
- Area must be free from vapors.
- Follow all cleanup instructions.
- **DO NOT** use gasoline to clean your sprayer.

1. Perform [Pressure Relief Procedure](#) (page 5).
2. Remove spray tip.
3. Dump out any remaining spray material from the hopper back into its container (see [Emptying the Hopper](#), page 5).
4. Fill the hopper with the appropriate cleaning solution.

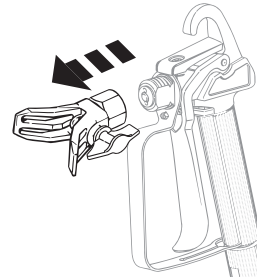

5. Place a waste container next to the original material container. Aim the spray gun into the side of the **original material container** and hold the trigger.
6. While holding the trigger, turn the pump ON (I) and turn the PRIME/SPRAY knob to SPRAY to purge material from the hose back into the original container.
7. When cleaning solution comes from the spray gun, keep holding the trigger and aim the spray gun into the side of the waste container (**ground gun with a metal container if flushing with flammable solvent**).
8. Trigger the gun until the fluid coming out of the gun is clear. You may need to dispose and obtain new cleaning solution.
9. Turn the PRIME/SPRAY knob to PRIME and trigger gun to relieve pressure.

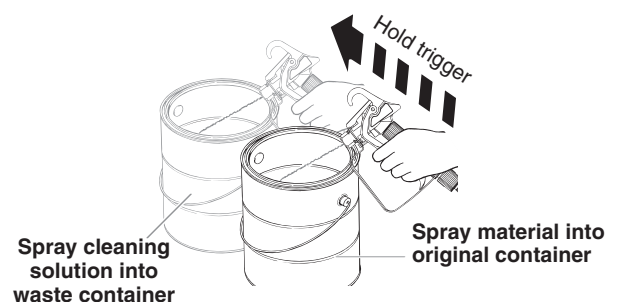
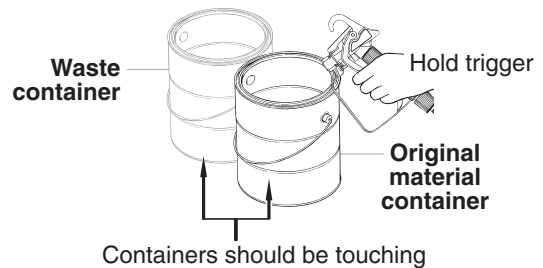

10. Thoroughly rinse out the hopper using the appropriate cleaning solution. **Make sure you do not drip any cleaning solution into the motor housing.**

11. Remove the inlet filter (a) and clean. Replace the filter.

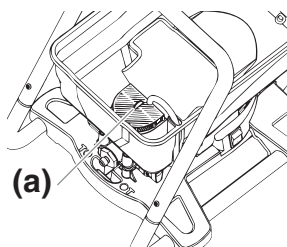

12. Fill the hopper with **NEW** cleaning solution.
13. Turn the PRIME/SPRAY knob to PRIME, and turn the pump ON.
14. Let the pump circulate the cleaning solution out the return tube for 2-3 minutes.
15. Turn the pump OFF and properly dispose of the cleaning solution.

Move on to [Cleaning the Spray Gun Components](#).

# Cleaning the Spray Gun Components

1. Perform [Pressure Relief Procedure](#), page 5. Remove spray gun from the paint hose using adjustable wrenches.
2. Remove filter (a) from spray gun (refer to [Unclogging the Spray Gun Filter](#), page 8). Remove spray tip (b) from spray guard assembly.
3. Clean spray tip (b) and filter (a) with a soft-bristled brush and the appropriate cleaning solution. Be sure to remove and clean the washer (c) and saddle seat (d) located in the rear of the spray guard assembly.
4. Pour a few drops of household oil inside the gun housing (see area indicated below by arrow).
5. Reassemble spray gun. Install gun filter tapered-end first, and install spray tip (b), saddle seat (d) and washer (c), and replace spray guard assembly.
6. Thread the paint hose back onto the spray gun. Tighten with a wrench.

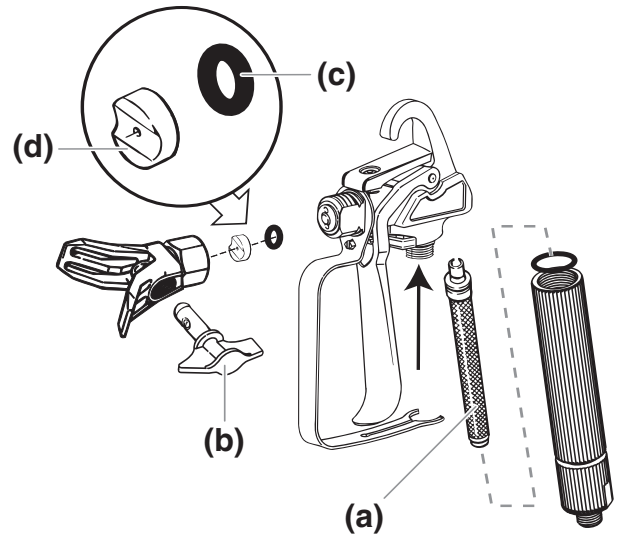

**IMPORTANT!** If you cleaned your pump using mineral spirits, it is recommended that you flush the pump again using warm, soapy water to prepare it for storage. Repeat steps 12-15 in [Cleanup](#) (previous page).

## Inlet / Outlet Valves

**Inlet Valve** - Cleaning or servicing the inlet valve may be required if the unit has priming problems. This may be caused by improper cleaning and/or storage. Replacement kits may be ordered by calling customer service.

1. Remove the inlet filter from the bottom of the hopper. You may need to use a screwdriver to pry the filter loose.
2. Insert the inlet valve tool into the inlet fitting. Twist counter-clockwise and remove from its housing. **You will need to attach the inlet valve tool to a ratchet wrench extension in order to remove it.**
3. Inspect the three inlet fitting O-rings on the inlet fitting. Clean or replace, and lubricate with household oil. **DO NOT remove the O-rings on the inlet fitting to clean them. Remove ONLY if you plan to replace them.**
4. Retrieve the inlet valve and the inlet valve O-ring from the inlet fitting housing. Clean or replace and lubricate the O-ring with a light household oil.
5. Set the inlet valve O-ring back into the housing, and set the inlet valve on top of it.
6. Replace inlet fitting into the housing. Tighten with the inlet valve tool and ratchet.

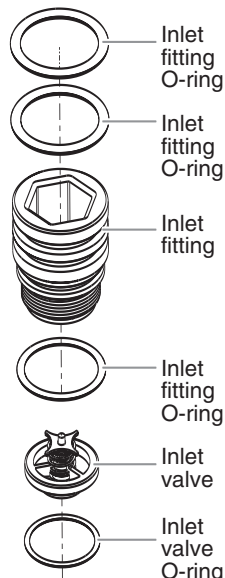
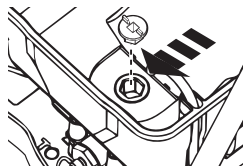

**Outlet valve** - Replacement of the outlet valve may be necessary if your spray performance remains poor after having performed all the steps contained in the [Spraying Troubleshooting](#) section of this manual. Replacement valves are available by calling customer service.

1. Unscrew the outlet valve from the outlet valve housing using an adjustable wrench.
2. Inspect the inside of the outlet valve housing. Remove any accumulated paint.
3. Replace with a new outlet valve. Tighten into outlet valve housing with an adjustable wrench.

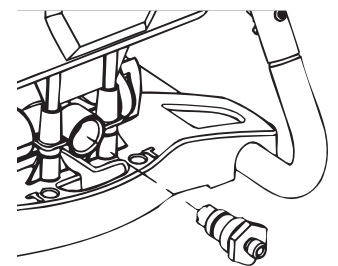

# Short Term Storage (up to 16 hours)

Follow these steps when using latex materials only. If using materials that are oil-based, follow the Cleanup and Long-Term Storage steps.

## Shutdown

1. Perform Pressure Relief Procedure, page 5. Unplug the sprayer.
2. Turn the PRIME/SPRAY knob to PRIME. Switch the pump OFF (O).
3. Pour 1/2 cup water slowly on the top of the paint to prevent the paint from drying. Wrap the spray gun assembly in a damp cloth and place it in a plastic bag. Seal the bag shut. Place the sprayer in a safe place out of the sun for short-term storage.

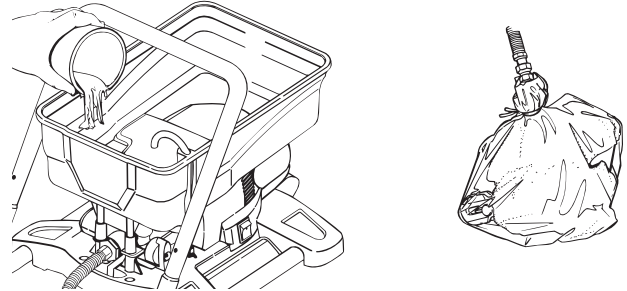

## Startup

1. Remove the gun from the plastic bag. Stir the water into the paint.
2. Turn the PRIME/SPRAY knob to PRIME. Plug sprayer in. Turn the switch to ON (I).
3. Turn the PRIME/SPRAY knob to SPRAY. Test the sprayer on a practice piece and begin spraying.

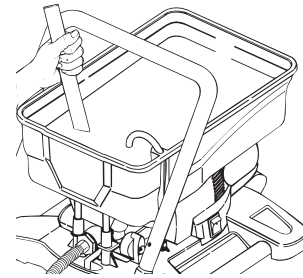

# Long-Term Storage

Make sure you have already completed the Cleanup steps on pages 9-10.

1. Remove the inlet filter (a). You may need to use a screwdriver to pry it loose.

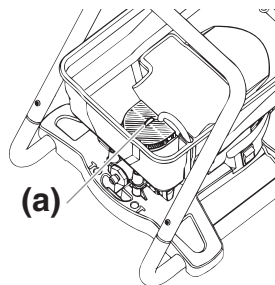

2. Pour approximately two ounces of light household oil into the inlet valve (b).

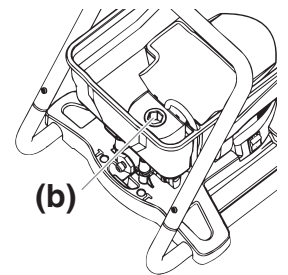

3. Remove hose from outlet valve, place a rag over the outlet valve, and turn the switch ON (I). Let the unit run for five seconds.

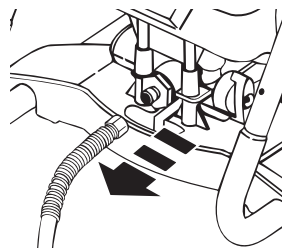

4. Turn the pump OFF (O)

5. Replace the inlet filter and push the tab on the filter (c).
6. Wipe entire unit, hose and gun with a damp cloth to remove accumulated paint. Replace the spray hose.



# Troubleshooting



Before servicing, always release system pressure by following [Pressure relief procedure](#) (page 5).

## Problem

## Cause

## Solution

A. The sprayer does not start.	<ol style="list-style-type: none"> <li>1. The sprayer is not plugged in.</li> <li>2. The ON/OFF switch is set to OFF.</li> <li>3. The sprayer shuts off while still under pressure.</li> <li>4. No voltage is coming from the wall plug.</li> <li>5. The extension cord is damaged or has too low a capacity.</li> <li>6. There is a problem with the motor.</li> </ol>	<ol style="list-style-type: none"> <li>1. Plug the sprayer in.</li> <li>2. Turn the ON/OFF switch to ON.</li> <li>3. Motor will cycle ON and OFF while spraying as it needs pressure. This is normal. Resume painting.</li> <li>4. Properly test the power supply voltage.</li> <li>5. Replace the extension cord.</li> <li>6. Take sprayer to Wagner Authorized Service Center.</li> </ol>
B. The sprayer starts but does not draw in paint when the PRIME/SPRAY knob is set to PRIME.	<ol style="list-style-type: none"> <li>1. The unit will not prime properly or has lost prime.</li> <li>2. The hopper is empty.</li> <li>3. The unit is not on level ground.</li> <li>4. The inlet filter is clogged.</li> <li>5. The inlet or outlet valve is stuck.</li> <li>6. The inlet valve is worn or damaged.</li> <li>7. The PRIME/SPRAY valve is plugged.</li> </ol>	<ol style="list-style-type: none"> <li>1. Try to prime the unit again.</li> <li>2. Refill the hopper.</li> <li>3. Relocate unit to level ground.</li> <li>4. Clean the inlet filter.</li> <li>5. Clean the inlet and outlet valves and replace any worn parts.* Inlet may be stuck from old paint. Push inlet filter tab to release.</li> <li>6. Replace the inlet valve.*</li> <li>7. Take sprayer to Wagner Authorized Service Center.</li> </ol>
C. The sprayer draws up paint but the pressure drops when the gun is triggered.	<ol style="list-style-type: none"> <li>1. The spray tip is worn.</li> <li>2. The inlet filter is clogged.</li> <li>3. The gun or spray tip filter is plugged.</li> <li>4. The paint is too heavy or coarse.</li> <li>5. The outlet valve assembly is dirty or worn.</li> <li>6. The inlet valve assembly is damaged or worn.</li> </ol>	<ol style="list-style-type: none"> <li>1. Replace the spray tip with a new tip.**</li> <li>2. Clean the inlet filter.</li> <li>3. Clean or replace the proper filter. Always keep extra filters on hand.</li> <li>4. Thin or strain the paint.</li> <li>5. Clean or replace the outlet valve assembly.*</li> <li>6. Replace the inlet valve.*</li> </ol>
D. The PRIME/SPRAY valve is on SPRAY and there is flow through the return tube.	<ol style="list-style-type: none"> <li>1. The PRIME/SPRAY valve is dirty or worn.</li> </ol>	<ol style="list-style-type: none"> <li>1. Take sprayer to Wagner Authorized Service Center.</li> </ol>
E. The spray gun leaks.	<ol style="list-style-type: none"> <li>1. Internal parts of the gun are worn or dirty.</li> </ol>	<ol style="list-style-type: none"> <li>1. Take the sprayer to a Wagner Authorized Service Center.</li> </ol>
F. The tip assembly leaks.	<ol style="list-style-type: none"> <li>1. The tip was assembled incorrectly.</li> <li>2. A seal is worn.</li> </ol>	<ol style="list-style-type: none"> <li>1. Check the tip assembly and assemble properly.</li> <li>2. Replace the seal.*</li> </ol>
G. The spray gun will not spray.	<ol style="list-style-type: none"> <li>1. The spray tip or the gun filter is plugged.</li> <li>2. The spray tip is in the CLEAN position.</li> <li>3. PRIME/SPRAY knob not set on SPRAY.</li> </ol>	<ol style="list-style-type: none"> <li>1. Clean the spray tip or gun filter. Review <b>Unclogging the Spray Tip</b>.</li> <li>2. Put the tip in the SPRAY position.</li> <li>3. Turn the PRIME/SPRAY knob to SPRAY.</li> </ol>
H. The paint pattern is tailing.	<ol style="list-style-type: none"> <li>1. The gun, the tip, or the inlet filter is plugged.</li> <li>2. The tip is worn.</li> <li>3. The paint is too thick.</li> <li>4. Pressure loss.</li> </ol>	<ol style="list-style-type: none"> <li>1. Clean the filters and strain the paint.</li> <li>2. Replace the spray tip.</li> <li>3. Thin the paint.</li> <li>4. Refer to Causes and Solutions for problem C.</li> </ol>

\* Special repair kits with instructions are available for these procedures. Refer to the [Maintenance](#) (page 12) section of this manual for a list of the kits and their part numbers.

\*\* Additional parts are available for this procedure. Refer to the [Accessories](#) (page 38) section of this manual for a list of the parts and their part numbers.

## Daily Maintenance

The only daily maintenance necessary is thorough cleaning. Follow the cleaning procedures in this manual.

## Extended Maintenance

Some pump parts eventually wear out from use and must be replaced. The following is a list of available repair kits. Pump performance is the only reliable indicator of when to replace wear parts. Refer to the Troubleshooting section for more information on when to use these kits.

Kit Part #	Description
0515221	Inlet valve seal kit
0515205	Outlet valve kit

# Parts List • Liste de pièces • Lista de piezas

## Sprayer • Pulvérisateur • Rociador

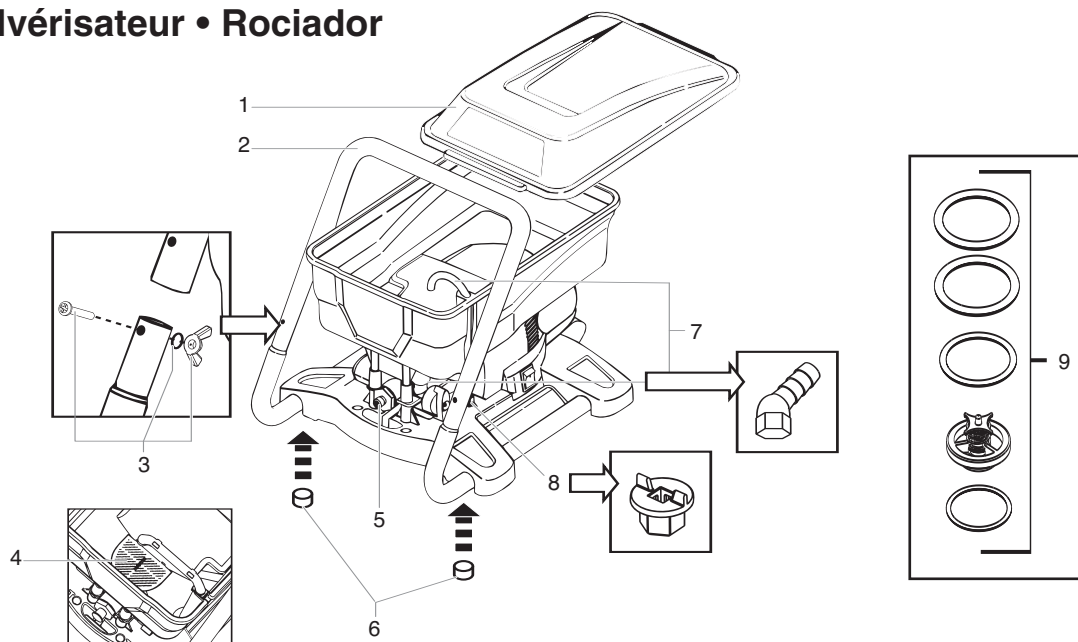

Item Article Artículo	Part No. N° de pièce Pieza No.	English - Description	Français - Description	Español - Descripción	Quantity Quantite Cantidad
1)	0515297	Handle, upper	Manchon	Mango	1
2)	0515223	Hopper lid	Couvercle de trémie	Tapa del recipiente	1
3)	0515225	Bolt, washer, and wing nut kit	Trousse de boulon, rondelle, et écrou	Juego de perno, rondana y tuerca	1
4)	0515417	Inlet filter	Filtre d'entrée	Filtro de entrada	1
5)	0515237	Outlet valve	Soupape de sortie	Válvula de salida	1
6)	0515999	Feet	Supports	Soportes	4
7)	0515226	Return tube / fitting	Tube de retour / raccord	Tubo de retorno / conector	1
8)	0515370	Inlet valve tool	Outil de soupape d'entrée	Herramienta de válvula de entrada	1
9)	0515221	Inlet valve seal kit	Trousse de joint de soupape d'entrée	Juego de sellos para la válvula de entrada	1

## Spray Gun • Pistolet • Pistola

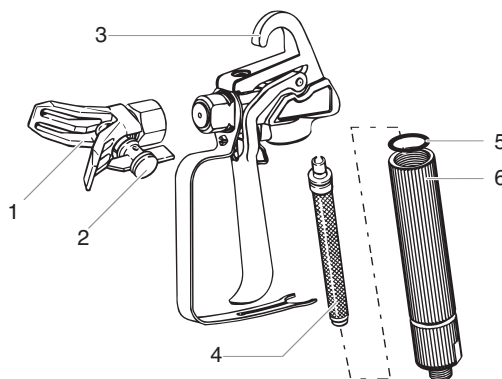

Item Article Artículo	Part No. N° de pièce Pieza No.	English - Description	Français - Description	Español - Descripción	Quantity Quantite Cantidad
1)	0501011	Guard assembly	Protège-embout	Ensamblaje de protección	1
2)	0501413	Tip, 413	Embout, 413	Boquilla, 413	1
3)	0515229	Complete gun assembly	Pistolet et ses composants	Ensamblaje de la pistola	1
4)	0154675	Filter, 100 mesh (yellow, 2 pack)	Filtre, maille 100 (jaune, trousse de 2)	Filtro, malla 100 (amarillo, juego de 2)	1
5)	0515228	Seal	Joint d'étanchéité	Sello	1
6)	0515227	Filter housing	Logement de filtre	Alojamiento	1



# Parts List • Liste de pièces • Lista de piezas

## Optional Accessories • Accessoires Optionnel • Accesorios Opcional

Part No. N° de pièce Pieza No.	English - Description	Français - Description	Español - Descripción
0270192	25' spray hose	25' flexible de pulvérisation	25' manguera del rociador
0154908	Separating oil	Huile séparatrice	Lubricante de empaques
0512130W	Tip extension, 12"	Rallonge d'embout, 30,5 cm	Extensión de la boquilla, 12"
0512131W	Tip extension, 24"	Rallonge d'embout, 61,0 cm	Extensión de la boquilla, 24"
0501411	411 Trade spray tip	Embout de pulvérisation, 411	Boquilla rociadora 411
0501413	413 Trade spray tip	Embout de pulvérisation, 413	Boquilla rociadora 413
0093930	Anti-seize compound	Composé antigrippage	Compuesto antiatascos
0154675	Yellow gun filter (2 pack)	Filtre de pistolet jaune (2)	Filtro de pistola amarillo (2)
0279109L	Pump Saver Plus Protector (lubricant)	Lubrifiant Pump Saver Plus Protector	Protector Pump Saver Plus (lubricante)

**These accessories are also compatible with SprayTech Apex Series sprayers.**

**Ces accessoires sont aussi compatibles avec les pulvérisateurs de SprayTech Apex Series.**

**Estos accesorios son también compatibles con rociadoras de SprayTech Apex Series.**

# Service Centers • Centres de service • Centros de Servicio

STATE	COMPANY	ADDRESS	CITY	ST	ZIP	NUMBER				
Alaska	Fluid Machinery Alaska Spray Center	151 A St Loop #1 7130 Upper Mesa Drive	Anchorage Palmer	AK	99518	907-563-5843				
				AK	99645	907-746-2377				
Alabama	E & E Coatings Dewalt Factory Service Sherwin Williams #4304* Southeastern Jack. Co. Quality Tool Repair Mercer Equipment Co Inc* Vrazel Chemicals	40 Red Hill Road 2412 Green Springs Hwy 1501 3rd Ave. So. 500 4th Ave. N. 6180 Hwy 31 2868 E Cottonwood Rd 11 N Broad St	Baileyton Birmingham Birmingham Birmingham Caiera Dothan Mobile	AL	35019	256-796-7160				
				AL	35209	205-942-0538				
				AL	35233	205-251-4125				
				AL	35204	205-252-1511				
				AL	35040	205-668-3131				
				AL	36301	334-794-9039				
				AL	36602	251-438-9947				
Arkansas	Accutrac Spray Equipment Nicks Equipment Oak Street Paint Tool Service Co. Lawnmowers Plus, Inc Markham Street Paint The Paint Depot Valley Coatings Sales Spectrum Paint	23329 Interstate 30 700 S German Lane 511 Oak Street 5732 Wheeler Ave 8223 Colonel Glenn Road 9809 West Markham 915 E 4th Street 905 East Main Street 399 E Robinson Rd	Bryant Conway Conway Fort Smith Little Rock Little Rock Russellville Russellville Springdale	AR	72022	501-847-4645				
				AR	72034	501-470-0313				
				AR	72032	501-336-8126				
				AR	72901	479-648-3125				
				AR	72204	501-565-7949				
				AR	72205	501-225-1678				
				AR	72801	479-967-7060				
				AR	72801	479-968-7071				
				AR	72764	479-751-8701				
				Arizona	VMC Enterprises JP's Paint Center Diversified Equipment Repair Complete Spray Systems Phoenix Spray Equipment Spraco West Prescott Spray Equipment Spray Technology, Inc Piston Power Engine Service Pump Solutions Beeler Equipment Co. Plaza Paint Store*	25550 West Hwy 85 415 S Main St Suite A 4187 S Roberts Rd 1420 N Hobson St 16601 N 25th Ave #104 2539 N. 35th Ave. #10 2500 N 5th Street # 14 1730 W 10th Pl. #8 3455 S. Palo Verde #117 50 W Drachman Street 1502 S 4th Ave 48 W 3rd ST	Buckeye Cottonwood Ft. Mojave Gilbert Phoenix Phoenix Prescott Valley Tempe Tucson Tucson Yuma Yuma	AZ	85326	623-386-2798
AZ	86326	928-634-3880								
AZ	86427	928-758-4168								
AZ	85233	480-464-5780								
AZ	85023	602-548-9848								
AZ	85009	602-229-1868								
AZ	86314	928-775-9298								
AZ	85281	480-968-4463								
AZ	85713	520-571-8558								
AZ	85705	520-791-7867								
AZ	85364	928-782-1689								
AZ	85364	928-782-2912								
California	Georges Airless Repair N.B. Sales & Service Janco Airless Conklin Paint & Supply Burney Rental Center Sales & Service Corlin Paint - repair site Lee's Tools CES-Concord Express Spray Equipment Center Spray Mart II Kirkland & Son Sierra Airless Westech Services Central Valley Airless Vista Paint Corp Knights Paint DK Power Spray Spray Doctor Responsive Tech Q & J Lawnmower Shop Delta Services California Electric Service Shilpark Paint Company Sprayco Service Center Rayco Industrial Supply* Ben's Airless Eastmont Paint* Dispensing Technology Empire Mowers Yossi Express Auto Repair Frontier Paint & Wallcovering Combee Electric* The Paint Bucket Corlin Paint - drop off site only M Enterprises Bay Saw & Tool Redding Paint Mart* Quick Fix* Rodeo Small Engine Co Airless Spray Center Valley Airless Systems Salinas Paint Supply Lee Lawnmower Corp Interstate Traffic Controls Products Coast Industrial Systems Airless Spray Repair of San Diego Fregosi & Company* Spray Mart II Moyers Paint Co. Contractors Maintenance Services Canbar Equipment Co Airless Spray & Pressure Washer Power King* Smith Paint & Supply Inland Paint Co. Benny's Spray Center Tim's Airless West Whittier Paint Co Rent-A-Spray Kayney Paints & Dec. Ctr. Jeff's Paint Center	12309 Locksley Lane 1610 South Union Ave 1235 5th Street 41250 Big Bear Blvd 37400 Mountain View Rd 1950 Whitman Rd 1924 N Long Beach Blvd 1170 - G Burnett Ave. 470 e Princland Ct #5 6447 Goldon Gate Dr 9874 Dino Dr., Ste 1 850 San Jose Ave #127 9088 Elkmont Way 90 E Escalante Ave Ste 117 2020 E Oragne Thorpe Ave 1219 Sutton Way 153 S Harvard St 11768 Mariposa Road 722 South Beach Blvd. 559 Whittier Blvd. 580 Third Street Unit G 22500 Muirlands Blvd. #B 1640 S Vermont Ave 1198 S. La Brea Ave. 512 River Rd 1513 1/2 Olympic Blvd 3027 West Beverly Blvd 5345 N. Commerce Ave, Unit #1 22410 Alessandro Blvd. 8806 Amigo Ave 227 Baldwin Rd 1619 E. Holt Blvd. 1051 W Holt Blvd 2780 Olive Highway 3607 E. Colorado Blvd. 498 East 10th St 2330 Larkspur Lane 9860 Indiana Ave #8 516 1st Street 7850 Cocamonga Ave #30 4021 California Ave 21 E. Laurel Drive 2115 S Bristol St 1700 Industrial Rd 3004 Main St 5835A Mission Gorge Rd #A 1090 Folsom Street 99 B Lewis Rd 351 Lewelling Blvd. 3440 B Sacramento DR 12525 Monterey Rd 2201 Bluebell Dr 221 Roberts Avenue 2875 Cherry Ave 117 W. Harding Way 3206 E Fremont St 7347 Van Nuys Blvd. 11408 E Whittier Blvd 11703 E Washington Blvd 5 Purity Plaza 2947 Colusa Highway	Auburn Bakersfield Berkeley Big Bear Lake Burney Chico Compton Concord Corona Dublin Elk Grove Clovis Elk Grove Fresno Fullerton Grass Valley Hemet Hesperia La Habra La Habra Lake Elsinore Lake Forest Los Angeles Los Angeles Modesto Montebello Montebello Moorpark Moreno Valley Northridge Ojai Ontario Ontario Oroville Pasadena Pittsburgh Pittsburh Riverside Rodeo Sacramento Carmichael Salinas Santa Ana San Carlos San Diego San Diego San Francisco San Jose San Lorenzo San Luis Obispo San Martin Santa Rosa Santa Rosa Singal Hill Stockton Stockton Van Nuys Whittier Whittier Woodland Yuba City					CA	95602	530-887-8799
								CA	93307	661-397-1950
								CA	94710	510-527-9770
				CA	92315	909-866-3878				
				CA	96013	530-335-5545				
				CA	95928	530-345-9595				
				CA	90221	310-639-1900				
				CA	94520	925-827-1011				
				CA	92879	951-278-5501				
				CA	94568	925-833-6906				
				CA	95624	916-686-5957				
				CA	93612	559-297-4785				
				CA	95624	916-685-8311				
				CA	78710	559-432-5813				
				CA	92831	714-680-3800				
				CA	95945	530-273-6401				
				CA	92543	951-652-5700				
				CA	92345	760-949-8458				
				CA	90631	562-697-4550				
				CA	90631	562-690-2772				
				CA	92530	951-245-5573				
				CA	92630	949-586-9440				
				CA	90006	323-732-7093				
				CA	90019	323-934-5669				
				CA	95351	209-529-8984				
				CA	90640	323-832-0893				
				CA	90640	323-887-1173				
				CA	93021	805-529-7733				
				CA	92553	909-697-6688				
				CA	91324	818-718-9390				
				CA	93023	805-646-0459				
				CA	91761	909-983-2238				
				CA	91762	909-983-2664				
				CA	95966	530-534-5180				
				CA	91107	626-792-2521				
				CA	94565	925-432-6291				
				CA	96002	530-221-7688				
				CA	92503	951-343-3499				
				CA	94572	510-799-0138				
				CA	95826	916-457-3111				
				CA	95608	916-944-2153				
				CA	93906	831-449-4212				
				CA	92704	714-546-6334				
				CA	94070	650-591-2300				
				CA	92113	619-232-3549				
				CA	92120	619-287-0380				
				CA	94103	415-431-6940				
				CA	95111	408-224-3830				
				CA	94580	510-278-0321				
				CA	93401	805-543-4558				
				CA	95046	408-683-9555				
				CA	95403	707-527-0118				
				CA	95401	707-527-5181				
				CA	90755	562-595-4761				
				CA	95204	209-466-0373				
				CA	95205	209-464-8844				
				CA	91405	818-785-9423				
CA	90601	562-692-7214								
CA	90606	562-696-6402								
CA	95695	530-666-9740								
CA	95993	530-671-2895								
Colorado	Front Range Airless Mayer Paint Equipment Paul's Airless Repair* Rhinnie's Sml Engine & Golf Cart Rep. Greeley Elctric Repair Air Compressor Service Inc White Cap Construction Supply Mountain Technology A-1 Rental & Sales Peterson Paint Center D & S Paint Center	7140 W 117th Ave Unit C-1 5390 West 38th Ave 125 4th St 209 E Skyway Dr 2509 8th Ave 386 27 1/2 Rd 2382 Leland Ave 4 Colorado Blvd 7215 Highway 50 901 W 8th St 715 West Street	Broomfield Denver Eagle Ft. Collins Greeley Grand Junction Grand Junction Idaho Springs Lamar Pueblo Pueblo	CO	80020	720-887-9500				
				CO	80212	303-422-2822				
				CO	81631	970-328-7219				
				CO	80525	970-223-9543				
				CO	80631	970-352-1961				
				CO	81501	970-245-1320				
				CO	81505	970-245-6787				
				CO	80452	303-567-4809				
				CO	81052	719-336-2772				
				CO	81003	719-543-4743				
				CO	81003	719-544-4714				
Connecticut	Shoreline Sprayworks Enfield Pump Repair	21 Meadow Rd Suite A-9 35 B Moody Road	Clinton Enfield	CT	06413	860-669-5883				
				CT	06082	860-749-8803				

# Service Centers • Centres de service • Centros de Servicio

Baltimore Electric Utility Electric Service R & D Services Sherwin-Williams #4303 *	5 Manila Ave 53 Main Street 45 Old Turnpike Rd 984 Silas Deane Hwy	Hamden Hartford Southington Wethersfield	CT CT CT CT	06514 06106 06489 06109	203-248-7553 860-246-7271 860-628-5205 860-563-1419
<b>Costa Rica</b>			<b>CR</b>		
Productos Siglo 21 shipping address	Apartado 51-6100 SJO/9099 7979 21st Street	Ciudad Colon Doral	CR FL	06100 33122	011-506-249-2673
<b>Delaware</b>			<b>DE</b>		
M & H Enterprises	1600 - B E. Newport Pike	Wilmington	DE	19804	302-995-7166
<b>Florida</b>			<b>FL</b>		
Mobile Hose & Spray Systems	6024 15th St E	Brandenton	FL	34203	941-751-5455
Cut & Farm of Brevard	624 Clearlake Rd	Cocoa	FL	32922	321-636-3276
Jack Harman Service	9950 SE 136 Ter	Dunnellon	FL	34431	352-489-5496
Auto Matic Repair Co	130 Florida St	Farmindale	FL	11735	631-420-0130
The Paint House	706 South U.S. 1	Ft. Pierce	FL	34950	772-465-5862
Greenbriar Mechanical Services	515-B Lovejoy Rd	Ft. Walton Beach	FL	32548	850-243-3062
Ace Spray Equipment	2417 W. Okeechobee Road	Hialeah	FL	33010	305-884-2465
Suncoast Tool Repair	14606 Marina Drive	Hudson	FL	34667	727-697-0134
Brinton's Paint	200 Park Street	Jacksonville	FL	32204	904-354-7707
Jacksonville Paint-Mobile Paint	249 Park Street	Jacksonville	FL	32204	904-355-5678
Quick Fix*	2607 Powers Ave	Jacksonville	FL	32207	904-730-5077
Lake City Industries	250 Nw Railroad St	Lake City	FL	32055	386-752-3511
Engle's Airless Repair & Equipment	14869 78 Place North	Loxahatchee	FL	33470	561-753-8133
Panhandle Paint Supply - drop off site	315 Hollywood Blvd	Mary Ester	FL	32549	850-243-7908
American Pump	2712 S Harbor City Blvd	Melbourne	FL	32901	321-724-2972
Atlantic Mower	4660 N Hwy 1	Melbourne	FL	32935	321-259-0095
O-Gee Paint Company	2855 S.W. 69 Court	Miami	FL	33155	305-266-0662
Palmetto Paint	14031 So. Dixie Highway	Miami	FL	33176	305-233-1224
Sherwin Williams #2487	SW 10855 72nd Street	Miami	FL	33173	305-596-2612
A 1 Tool & Fastener	1851 Blanding Blvd	Middleburg	FL	32068	904-282-3707
Tool Doctor*	1825 N. Magnolia	Ocala	FL	34475	352-622-5655
Handy Rentals, Inc*	2035 Bruton Blvd	Orlando	FL	32805	407-841-4540
Palm Paint Company	1010 So. Nova Road	Ormond Beach	FL	32174	386-677-8020
A & J Pump Repair	3 Industry Dr Unit #6	Palm Coast	FL	32137	386-447-4482
Panhandle Paint Supply - drop off site	8103 PCB Parkway	Panama City Beach	FL	32408	850-235-7900
Panhandle Paint Supply - repair site	2433 Jenks Ave	Panama City	FL	32405	850-872-9100
A-1-A Small Engines & Equipment	420 So. Dixie Highway East	Pompano Beach	FL	33060	954-946-5044
Tri-County Equipment & Repair Inc	1551 SE Niemeyer Circle	Port St. Lucie	FL	34952	772-337-3377
Air Hydraulic Electric Service	515-A 22nd St So	St. Petersburg	FL	33712	727-526-4513
Northside Mower	3320 N. Monroe Street	Tallahassee	FL	32303	850-562-2962
Assurance Spray Equipment	4419 N Hubert Ave	Tampa	FL	33614	813-873-2866
Mark's Mobile Lawn Equip. & Repair	6733 Bonnie Blue Dr	Wesley Chapel	FL	33544	813-994-0072
Webb Wholesale	1042 B South Congress Ave	W Palm Beach	FL	33406	561-964-9995
Dixie Power Equipment*	1401 Allendale Road	W. Palm Beach	FL	33405	561-689-4468
Rogers Engines	1100 N Florida Mango Rd	W. Palm Beach	FL	33409	561-689-8300
<b>Georgia</b>			<b>GA</b>		
Artway Paints & Supply	2236 Lakewood Ave. S.W.	Atlanta	GA	30315	404-627-7781
Little Enterprises	106 Nowhere Rd	Athens	GA	30601	706-548-4876
Spray Solutions	3905 A Roberts Rd	Augusta	GA	30907	706-855-1293
Assured Air Inc	2504 Buoy 32 East	Douglas	GA	31533	912-384-9599
A.S.A.P. Equipment Services	3562 Suiford Hwy, Suite 103	Duluth	GA	30086	678-584-5462
Ellerslie Hardware & Small Engine	12275 Warm Springs Road	Ellerslie	GA	31807	706-569-0800
Gainesville Paint	528 Bradford ST SW	Gainesville	GA	30501	770-532-3146
Thomas Spray Repair	968 B Hiram Douglasville Hwy	Hiram	GA	30141	770-943-7727
Riverbend Wholesale	145 Riverbend Drive	La Grange	GA	30240	706-812-9270
The Pump Store	975 Cobb Place Blvd Suite 116	Kennesaw	GA	30144	770-499-0000
Acme Airless Sales & Service	1979 Riverside Drive	Macon	GA	31201	478-743-9336
Rock Street Airless*	36 Rock St	Marietta	GA	30060	770-425-5251
The Pump Store	5942 Goshen Springs Rd	Norcross	GA	30071	770-246-0044
29 Hwy Jimmy Carter Spray Service	4165B Jimmy Carter Blvd	Norcross	GA	30093	678-534-0196
S & S Tool Repair	1215 Talking Rock Rd	Jasper	GA	30143	706-692-1855
American Airless*	7960 Suite C - Highway 85 So.	Riverdale	GA	30274	770-477-1337
Mայcrest Hardware	1609 Montgomery Crossroads	Savannah	GA	31406	912-354-2045
Maple Park Corp	340 MLK Jr Blvd	Savannah	GA	31401	912-232-2906
Industrial Controls	1710 Eastman Dr	Tifton	GA	31794	229-386-2929
Elite Image Professional Service	6790 Bells Ferry Rd Suite B	Woodstock	GA	30189	678-445-0200
<b>Hawaii</b>			<b>HI</b>		
Airless Mobile 1	1353 Dillingham Blvd	Honolulu	HI	96817	808-944-1742
Danny's Airless	830 Mapunapuna Street	Honolulu	HI	96819	808-839-7771
<b>Iowa</b>			<b>IA</b>		
Brozene Hydraulic Service	1400 Mt. Pleasant	Burlington	IA	52601	319-752-4017
Paint Pump Pro's	3410 SW 9th Street	Des Moines	IA	50315	515-244-3611
Blink Electric Motors Inc.	Rear 116 North 1st Avenue	Marshalltown	IA	50158	641-752-3036
<b>Idaho</b>			<b>ID</b>		
Rossiter Electric Motor	1501 South Capital	Idaho Falls	ID	83402	208-529-3665
KC Power Shop	4810 Chinden Blvd	Boise	ID	83714	208-327-9584
Airless Systems Restoration	1306 Elmwood Circle	Twin Falls	ID	83301	208-320-0580
<b>Illinois</b>			<b>IL</b>		
Equipment Doctor	190 Easy St	Carroll Stream	IL	60188	630-510-0022
Majestic Janitorial Service & Supply	1703 W. Main	Carbondale	IL	62901	618-529-9001
Weston's Lawn Equipment	RR3 Box 297 B	Lawrenceville	IL	62439	618-943-5510
Superior Small Engine	15062 South Archer Ave	Lockport	IL	60441	815-588-1200
Mid Valley Building Center	700 N Market	Marion	IL	62959	618-997-3379
North Park Rental Service, Inc	9624 N 2nd St	Mechesney Park	IL	61115	815-633-9234
All Brand Compressor Service	2412 4th Ave	Moline	IL	61265	309-764-4852
Mid Valley Power & Supply	119 1st St	Mounds	IL	62964	618-745-6452
Tool Repair Service	23824 Andrew #104	Plainfield	IL	60585	815-609-8941
M & M Small Engine Repair	325 South Main	Shiloh	IL	62269	618-632-8064
B & P Power Sales*	700 South 4th	Quincy	IL	62301	217-224-9035
<b>Indiana</b>			<b>IN</b>		
Oscar's Small Engine	4438 E 100 N	Bluffton	IN	46714	260-565-3350
R & C Small Engine	13630 Wicker Ave Suite A	Cedar Lake	IN	46303	219-374-9660
Finishline Technologies	13399 W Wildflower Dr	columbus	IN	47201	812-372-3493
Tri-State Vacuum Co	1936 Fairfield Ave	Fort Wayne	IN	46802	260-969-0626
Complete Hydraulic Sales & Service	130 Commerce Park Dr	Franklin	IN	46131	317-736-5094
Lear Unlimited	2204 N Wolfe St	Muncie	IN	47303	765-282-6273
Sherwin Williams 1005	1220 S. Main	South Bend	IN	46601	574-233-3976
Pro Trade Tool & Supply*	1209 E. Poplar Street	Terre Haute	IN	47807	812-235-8665
<b>Kansas</b>			<b>KS</b>		
Mid Kansas Tool Works	314 W. Cloud	Salina	KS	67401	785-825-6287
Gragg's, Inc	4410 SW 21st St	Topeka	KS	66604	785-272-8818
Whiteley's Tool & Repair	211 NW Norris	Topeka	KS	66608	785-232-9913
<b>Kentucky</b>			<b>KY</b>		
Perspectives, Inc.	352 Longview Drive	Lexington	KY	40503	859-277-0521
Smiley's Air Tool	4552 Poplar Level Road	Louisville	KY	40213	502-966-3433
Southside Equipment	9406-B Old Bardstown Rd	Louisville	KY	40291	502-231-6506
Newton's Tool Service	2316 Bluff Ave. Bldg K	Owensboro	KY	42303	270-691-0466
Crown Rental	1014 W. Columbia Street	Somerset	KY	42503	606-679-4267
McCurry Tractors Inc	775 N. Hwy 27	Somerset	KY	42503	606-679-1019
<b>Louisiana</b>			<b>LA</b>		
Tri-Star Sales & Repair	46327 Milton Road	Hammond	LA	70401	225-567-4867

# Service Centers • Centres de service • Centros de Servicio

	Spray Fix Robert's Repair Rental DM Spray Equipment Mechanical Arts BP Services & Repair Caddo Paint	41318 W Yellow Water Rd 4919 LA 182 207 N Cushing Ave 600 S Perkins Ferry Rd 14169 Highway 73 480 E Bert Kouns	Hammond Houma Kaplan Lake Charles Prairieville Shreveport	LA LA LA LA LA LA	70403 70364 70548 70611 70769 71106	504-432-8799 985-872-0896 337-643-3252 337-855-4247 225-677-9213 318-869-3000
<b>Massachusetts</b>	South Shore Tool & Airless Reapair Murphy's Inc Whitman Equipment	16 Brookside Rd 134 East St 396 South Ave	Braintree Weymouth Whitman	MA MA MA	02184 02189 02382	781-848-2706 781-337-0178 781-447-4496
<b>Maryland</b>	Budeke's Paints, Inc. WTS, Inc.* Harrington & Sons*	418 S. Broadway 4000 Coolidge Ave Suite C 427 E Main St	Baltimore Baltimore Baltimore	MD MD MD	21231 21227 21727	410-732-4354 443-543-0100 301-447-6666
<b>Maine</b>	Maine Paint	517 Warren Ave.	Portland	ME ME	04103	207-767-3338
<b>Michigan</b>	Related Auto Care Joes Lawn & Garden State Street Hardware Total Tool & Equipment Service REB Enterprises Sherwin Williams Co #1853 Oleary Paint Contractors Repair Mac's Service Equipment Company Norm's Electric Motor Repair Superior Electric Mid-Michigan Repair Services KC's Electric Airless Unlimited	922 1/2 E Beecher St 1141 26 Street M-89 614 N State 200 N 12th St G-3365 Richfield Rd 440 Grandville Ave SW 41 Buckley St SW 13612 Woodbury Rd 21109 Dequindre Rd 414 Wlabridge 1740 Presque Isle Ave 680 Poseyville Rd 1240 West Sanilac Ste B 9740 Holland	Adrian Allegan Big Rapids Escanaba Flint Grand Rapids Grand Rapids Haslett Hazel Park Kalamazoo Marquette Midland Sandusky Saginaw	MI MI MI MI MI MI MI MI MI MI MI MI MI MI	49221 49010 49307 49329 48506 49503 49503 48940 49030 49007 49855 48640 48471 48601	517-263-9066 269-673-8736 231-796-8122 906-786-7242 810-736-1772 616-456-1436 616-233-0499 517-339-5709 248-548-5200 269-382-5054 906-226-9051 989-835-6014 810-648-7111 989-652-4980
<b>Minnesota</b>	Quality Paint & Supply Painters Gear London Rental Center Fluidtech Empowered Equipment True Value Home Center Stiffers.com CJ Spray Inc Pete's Electric Motor Repair Range Paint & Varnish, Inc. Lackore Electric Motor Repair	305 Paul Bunyon Drive 1208 E. American Blvd 1710 London Road 21335 Aberdeen Street NE 6823 Narcissus Lane N 500 N Hwy 59 214 West Elm St 370 Airport Rd 2048 County Rd 24 802 6th Ave North 108 W, 2nd Street	Bemidji Bloomington Duluth East Bethel Maple Grove Marshall Norwood-Young America South Saint Paul Minneota Virginia Winona	MN MN MN MN MN MN MN MN MN MN MN	56601 55425 55812 55011 55311 56258 55368 55075 56264 55792 55987	218-751-4418 952-854-2300 218-728-2940 763-434-8812 952-210-0370 507-532-3296 952-467-2044 651-455-0880 507-428-3585 218-741-3700 507-452-3103
<b>Missouri</b>	Dar Co Equipment Service Co. PDQ Sales & Service MAB Paints Pump Doctor Airless Repair Mikerentals Hydraflow Equipment Co. St. Louis Shaver & Appliance	6519 Stadium Drive 1200 Swift 11974 Dorsett Rd 1754 Scherer Parkway 109 Laurel 8125 Brentwood Industrial Drive 940 Lemay Ferry Rd	Kansas City N. Kansas City Maryland Heights St. Charles Sileston St. Louis St. Louis	MO MO MO MO MO MO MO	64129 64116 63043 63303 63801 63144 63125	816-924-1245 816-842-3047 314-989-9009 636-946-7373 573-4727907 314-644-6677 314-544-7989
<b>Mississippi</b>	Gleem Paint Center M & W Hydraulic Service RD Compressor & Tools Blaylock Electric Motor Shop	2300 Pass Road 4626 Van Winkle Park Drive 1003 A South Peason Rd 502 S Spring St	Gulfport Jackson Pearl Tupelo	MS MS MS MS	39501 39209 39208 38804	228-863-3942 601-922-4418 601-933-4991 662-842-7803
<b>Montana</b>	The Paint Center Big Sky Power Equipment NorthShore Saws & Mower	1904 Grand Ave 1301 3rd St NW 2150 Mt Hwy 35	Billings Great Falls Kalispell	MT MT MT	59102 59404 59901	406-656-6008 406-761-6688 406-257-6609
<b>Nebraska</b>	Flohr Electric Service Paint Pump Pros	4356 SO 90th Street 4149 S. 87th St.	Omaha Omaha	NE NE	68127 68127	402-331-6863 402-597-7480
<b>New Hampshire</b>	Ray's Putt Putt Shop	14 Wathen Road	Bedford	NH NH	03110	603-622-6859
<b>New Jersey</b>	Siperstein's Cape Power Equipment Cougar Electronics & Tool Repair Middlesex Industrial Sales Siperstein's Industrial Repair J & J Repair Center Siperstein's Conroy's Corner Repair Center Conroy's Corner Stores	326 South Washington Ave. 1179 Rlyte 9 South 622 Broadway 522 New Brunswick Ave. 372 New Brunswick Ave. 169 Asbury Ave Building A 4312 Rt 9 South 338 Route 9 North 800 S. White Horse Pike 126 Haddon Ave.	Bergenfield Cape May Court House Long Branch Fords Fords Freehold Howell Manalapan Somerdale Westmont	NJ NJ NJ NJ NJ NJ NJ NJ NJ NJ	07621 08210 07740 08863 08863 07728 07731 07726 08083 08108	201-385-4800 609-465-4050 732-870-3302 732-738-0537 732-738-8300 732-5770055 732-901-2525 732-780-2000 856-784-3688 856-854-1980
<b>New Mexico</b>	Aladin Enterprises Albuquerque Airless Action Airless/Performance Painting	6021 Edith NE 2517-A Quincy NE 2200 Menaul Blvd NW	Albuquerque Albuquerque Albuquerque	NM NM NM	87107 87110 87107	505-345-4756 505-884-8822 505-761-9948
<b>Nevada</b>	BC Paint & Rent All* QT Pump Repair Paint Sprayers Unlimited Sherwin-Williams 8111* M & R Spray Rig Repair Reno Paint Mart	1504 Nevada Highway 385 Hot Springs Rd 3125 So. Highland Drive 6285 south Valley View Blvd 4211 Production Ct 201 E Monana Ln	Boulder City Carson City Las Vegas Las Vegas Las Vegas Reno	NV NV NV NV NV NV	89005 89106 89109 89102 89115 89502	702-293-3656 775-884-1003 702-731-5688 702-382-4995 702-884-5322 775-826-2900
<b>New York</b>	C & S Spray Equipment J & A Repair Shop Solomon's Appliance Service Clark's Tool Repair Schnitter's Paint A & T Power Tools* RGB Sprayer Parts The Warranty Center Precision Propeller & Tool Mor Power Equipment Stewart Electric Repair Co Del-Monte-Bremiller Inc R & D Mower Painters Equipment & Supply	76 Exchange Street 6206 20th Ave 1701 86th Street 976 Rogers Ave 2917 Bailey Ave. 515 East Jericho 136 Compton Rd 16 Church Street 135 S. William Street 207 Oak Tree Rd 412 Broadway 1125 Stark St 1632 Empire Blvd 157 Tibbetts Rd	Albany Brooklyn Brooklyn Brooklyn Buffalo Hunting Station Ithaca Kings Park Newburgh Palisades Schenectady Utica Webster Yonkers	NY NY NY NY NY NY NY NY NY NY NY NY NY NY	12205 11204 11214 11226 14215 11746 14850 11754 12550 10964 12305 13502 14580 10705	518-459-7772 718-232-5746 718-236-5065 718-282-3147 716-838-2500 631-271-2141 607-272-1889 631-269-5054 845-562-3880 845-398-7368 518-393-5837 315-735-6191 585-671-9409 914-965-2922
<b>North Carolina</b>	Myers Service Distribution Bosco Lowe Ent Inc McGuire Air Compressors Hall Equipment Company, Inc. Express Pump Repair  Terry's Airless Repair Center	1115 Commercial Ave 16 Sleigh Ride Lane 729 E Elm St 808 Huffman Street 4507 Burning Tree Dr  608 Old Thomasville Rd Suite 105	Charlotte Fletcher Graham Greensboro Greensboro  High Point	NC NC NC NC NC  NC	28205 28732 27253 27405 27406  27262	704-334-3333 828-628-2731 336-229-9999 336-274-2305 336-674-1874 336-207-1910 336-889-0970



# Service Centers • Centres de service • Centros de Servicio

Team Compressor Service	1513 Dale Earnhardt Blvd	Kannapolis	NC	28083	704-933-9020
DJM Tool	997 Salem Church Rd	Lincolnton	NC	28092	704-736-0671
Genes Service Center (GSC)	801 Broad Creek Rd	New Bern	NC	28560	252-633-2987
J & S Tool Repair	1309 Hodges St	Raleigh	NC	27604	919-856-0050
Hufhams Small Engines	3301 NC Hwy 133	Rocky Point	NC	28457	910-675-2029
Interstate Supply	511 Union West Blvd	Stallings	NC	28104	704-893-2878
Andy's Lawnmower	9098 Hwy 58 N	Stantonsburg	NC	27883	252-238-2341
Sylva Rental	1674 E Main St	Sylva	NC	28779	828-631-1227
Bear Paw, Inc	221 Too Sweet Rd	Sylva	NC	28779	828-631-2327
Express Pump Repair	610 Highgreen Dr	Wilmington	NC	28411	910-686-3723
<b>North Dakota</b>					
united Rentals Northwest	3925 East Divide Ave	Bismark	ND	58501	701-222-1040
<b>Ohio</b>					
Erich's Repair	2386 C R 250	Antwerp	OH	45813	419-258-2883
Falls Supply Inc	8309 E Washington	Chagrin Falls	OH	44023	440-543-8474
North East Mower Service	412 East 156 Street	Cleveland	OH	44110	216-531-8197
M & E Equipment Service	981 W 6th Ave	Columbus	OH	43212	614-298-9670
Penningtons Mower Shop	117 Greenfield Sabina Rd	Greensfield	OH	45123	740-334-5367
M & M Service	8932 State Route 14	Streetsboro	OH	44241	330-626-2520
Mr. Appliance of Toledo	1621 Broadway	Toledo	OH	43609	419-241-9731
Spray Repair Service	3704 Marine Rd	Toledo	OH	43609	419-385-6411
Automotive Industrial Supply & Equipment	241 Quadral Drive	Wadsworth	OH	44281	330-334-8000
E & E Sales and Service	12685 Gore Orphanage Rd	Wakeman	OH	44889	440-965-4074
The Tool Shop, Inc	38130 Airport Pkwy #4	Willoughby	OH	44094	440-946-9950
JAD Equipment	1000 Andrews Ave	Youngstown	OH	44505	330-746-6100
YSE Equipment	3142 Southern Blvd	Youngstown	OH	44507	330-788-4023
<b>Oklahoma</b>					
Batey Small Engines	801 N. Mississippi	Ada	OK	74820	580-436-4804
Painter's Equipment Rental Inc.	9718 S 232nd East Ave	Broken Arrow	OK	74014	918-258-1717
Spray Tech Systems	4631 N.W. 3rd Street	Oklahoma City	OK	73127	405-948-8696
D & L Engine & Hydraulics	401 N McKinley	Marlow	OK	73055	580-658-5489
Jones Repair Service	4711 N. Meridian	Oklahoma City	OK	73112	405-789-3240
<b>Oregon</b>					
Sherwin-Williams 8603*	125 NE Franklin	Bend	OR	97701	541-389-2536
Forrest Paint Company	1011 McKinley West	Eugene	OR	97402	541-342-1821
Klamath Airless & Spray Equipment*	2328 Wiard Street	Klamath Falls	OR	97603	541-882-1460
Precision Power Tool Repair	2941 N Pacific Hwy	Medford	OR	97501	541-770-5541
Portland Compressor, Inc.	310 S.E. 12th Avenue	Portland	OR	97214	503-235-0200
Redmond Tool & Supply	1610 SW Veterans Way	Redmond	OR	97756	541-504-8283
Tim Allen Commercial Equipment Repair	2646 Diamond Lake Blvd	Roseburg	OR	97470	541-672-3409
<b>Pennsylvania</b>					
Hydraulic Industrial Supplies*	300 E. Madison Ave.	Clifton Heights	PA	19018	610-284-2100
Dave's Spray Equipment Repair	207 N Reamstown Rd	Denver	PA	17517	717-335-2658
Jamisons Airless Paint Systems	125 Grandview Rd	Ellwood City	PA	16117	724-758-6036
Ace Hardware	6027 National Pike	Grindstone	PA	15442	724-785-4100
Cleaning Equipment Supply (CESCO)	122 Rosehill Ave	West Grove	PA	19390	610-869-8227
Petrosky's Pro Hardware & Supply	602 Alexandria St	Latrobe	PA	15650	724-537-3541
Latrobe Tool Service	4339 Route 30	Latrobe	PA	15650	724-532-1411
Dave Nanna Tool Repair	6105 Blue Grass Ave.	Lingelstown	PA	17112	717-657-1595
Small Engine World	130 E O'Hara St	McDonald	PA	15057	724-926-3330
New Enterprise Small Engine*	3409 Brumbaugh Rd	New Enterprise	PA	16664	814-766-2117
Pittsburgh Spray Equipment	3601 Library Rd	Pittsburgh	PA	15234	412-882-4550
Bruder Sons #148	37 Baltimore Pike	Springfield	PA	19064	610-328-0788
Stroudsburg Electric Motor Service	756 Phillips St	Stroudsburg	PA	18360	570-421-8909
Conroy's Corner Store	126 North Wayne Ave.	Wayne	PA	19087	610-688-7070
Dave's Repair	1840 Liberty Dr.	Williamsport	PA	17701	570-494-1716
<b>Rhode Island</b>					
The Paint Shoppes	1329 Warwick Ave	Warwick	RI	02888	401-463-5262
Rhode Island Rentals	111 Plan Way	Warwick	RI	02889	401-738-9731
<b>South Carolina</b>					
Mr. Handy Rentals, Sales, and Service	339 Jackson St	Barnwell	SC	29812	803-541-7050
The MacMaster Co. Inc.	965 Westfield Court	Sumter	SC	29154	803-494-3441
Conway Electric Motor Service	402 Lewis Street	Conway	SC	29526	843-248-5302
Bill's Small Engine Repair	108 Railroad Ave	Lexington	SC	29072	803-359-3589
Coastal Pressure	1135 Bowman Road, Suite 513	Mt. Pleasant	SC	29464	843-849-7150
<b>South Dakota</b>					
Dakota Spray Equipment	1715 Samco Rd # 106	Rapid City	SD	57702	605-718-4402
<b>Tennessee</b>					
Underwood Repair Service	1706 Antioch Pike	Antioch	TN	37013	615-833-2022
Vista Small Engine	1510 Vista Lane	Clarksville	TN	37043	931-552-6953
ARB Enterprises Inc	1509 E 28th St	Chattanooga	TN	37404	423-624-4429
Lookout Spray Equipment	3419 Dayton Blvd.	Chattanooga	TN	37415	423-877-3125
Chattanooga Paint & Dec	5529 Hixson Pike	Hixson	TN	37343	423-843-9286
Herrin Lawn & Power Equipment	113 Park Ave N	Hohenwald	TN	38462	931-796-2666
Volunteer Hydraulic Service	1714 Indian Ridge Rd	Johnson City	TN	37601	423-928-4661
Warranty One Mobile Mower Repair	1785 Ft. Henry Dr	Kingsport	TN	37664	423-245-7303
ICI Paint	1918 N Broadway	Knoxville	TN	37917	865-523-6138
Whitey's Small Engine	1121 Sparta St	McMinnville	TN	37110	931-473-2314
Gordan Air Compressor Equip Co	706 Scott St	Memphis	TN	38112	901-327-1327
Authorized Equipment Service	812 Polk Ave	Memphis	TN	38126	901-774-0850
Parrish Equipment	3828 Clarksville Highway	Nashville	TN	37218	615-242-7525
Sherwin Williams #4319/Sherworks	701 Lea Ave	Nashville	TN	37203	615-256-1157
<b>Texas</b>					
Airless Service	1357 Ruswood Drive	Abilene	TX	79601	325-677-7783
Tesco Equipment Supply	1024 Walnut St	Abilene	TX	79601	325-676-8241
Reid's Appliance	906 Georgia	Amarillo	TX	79102	806-373-8812
Jovo's A-Team Rentals	1718 East 10th	Amarillo	TX	79102	806-373-8326
Wiccacon Enterprises	300 Magnolia St., Bldg 19	Anthony	TX	79821	915-886-3337
E.A.H.	9514 McNeil Rd Suite 105	Austin	TX	78758	512-339-7788
Earl's Repair Center Inc	7900 Hwy 71 W, Suite A	Austin	TX	78735	512-288-1334
Faz Equipment	2009 Peachtree Rd	Balch Springs	TX	75180	972-285-1136
Baytown C&M Equipment Co.	508 Cedar Bayou Rd.	Baytown	TX	77520	281-428-7045
Spray Pump Inc	719 E Pearce St	Baytown	TX	77520	281-422-0319
Navarro's Small Engine	3443 Burton Dr	Brownsville	TX	78521	956-542-0318
Tom's Small Engine	1490 SW Wilshire Blvd	Burleson	TX	76028	817-447-0295
Ambulance Repair Service	3030 CoRd 49-A	Corpus Christi	TX	78415	361-855-9881
L M Spray Equipment Co.*	4540 Baldwin	Corpus Christi	TX	78408	361-883-1445
Dallas Spray Equipment	7230 C.F. Hawn Freeway	Dallas	TX	75217	214-391-3908
Metroplex Spray Equipment	2332 Joe Field Road #123	Dallas	TX	75229	972-620-9680
Grayson Compressor Service	2525 W Morton Street	Denison	TX	75021	903-465-2355
Geo S. Thomsom	3738 Durazno Ave	El Paso	TX	79905	915-544-8000
Bob Taylor's Spray Equipment*	5700 James Avenue	Fl.Worth	TX	76134	817-551-1525
The Tool Clinic	4100 Haltom Rd Ste A	Haltom City	TX	76117	817-656-5640
Perdue Paint Equipment	627 E Veterans Memorial Blvd	Harker Heights	TX	76548	254-699-4907
E.A.H.	901 Ashland	Houston	TX	77008	713-869-6594
L M Spray Equipment Co.*	1410 Shepherd Dr	Houston	TX	77007	713-861-4108
Integrity Tool Service	6223 A Southwest Fwy	Houston	TX	77074	713-988-8665
L & A Products	9909 Harwin Dr	Houston	TX	77036	713-789-0104
Walker Spray Repair	860 Hembry Suite 203	Lewisville	TX	75057	972-420-9825
A & L Lawn Equipment	2424 Rock Island	Irving	TX	75060	972-986-1524



# Service Centers • Centres de service • Centros de Servicio

Craine Service Center	239 Dale Drive	Kilgore	TX	75662	903-984-8894
David Dunn Repair Service	3506 34th Street	Lubbock	TX	79410	806-792-1770
Universal Repair	4022 Englewood Ave	Lubbock	TX	79407	806-795-5850
Powers Spray Equipment Co.	2414 E. Highway 80 #260	Mesquite	TX	75149	972-289-3113
Quatro Products	3220 Kermit Hwy	Odessa	TX	79764	432-332-3366
Perpetual Equipment Service	941 Madrona Ranch Rd	Pipe Creek	TX	78063	930-510-2406
Valley Outdoor Power Equipment	1012 E 495 Ferguson Rd	Pharr	TX	78577	956-787-0469
Daniels Rental	2118 N Hwy 288B	Richwood	TX	77531	979-265-5291
West Texas Airless Repair	3621 Old Post Court	San Angelo	TX	76904	325-656-1481
E.A.H.	136 El Mio	San Antonio	TX	78216	210-822-9393
Industrial Equipment*	637 East Crocket Street	San Antonio	TX	78202	210-225-1312
M & K Equipment	7228 Eckherth Rd	San Antonio	TX	78238	210-509-9697
DKR Repair	16163 Hwy 64E	Tyler	TX	75707	903-566-8158
Victory Air & Equipment	903 Profit Dr	Victoria	TX	77901	361-573-0819
Ludwig Saw & Tool Sharpening	1701 Maple Ave	Waco	TX	76707	254-754-6951
Maverick Sales	261 US Hwy 281	Wichita Falls	TX	76310	940-723-4473
<b>Utah</b>			<b>UT</b>		
Jones Paint & Glass	38 East 1600 North	Cedar City	UT	84720	435-586-3800
Industrial Tool & Supply	839 N Main St	Logan	UT	84321	435-753-4256
Action Airless Repair	52 West 500 South #6	Provo	UT	84601	801-375-5638
Gustin Hydraulics	151 West 2125 S	Salt Lake City	UT	84115	801-487-0624
Alta Paints & Coatings	136 West 3300 South	Salt Lake City	UT	84115	801-466-9625
Jones Paint & Glass	122 S. 1200 E.	St. George	UT	84770	435-673-9644
<b>Virginia</b>			<b>VA</b>		
D & S Repair	20 South Dove Street	Alexandria	VA	22314	703-683-0009
Painters Equipment & Repair	13429 Namozine Rd	Amelia	VA	23002	804-475-3879
Wigwam Industries	4950 Meeks Run	Crozet	VA	22932	434-823-4663
E & S Enterprises	11001 Pierson Dr Suite F	Fredericksburg	VA	22408	540-368-5590
Bennette Equipment Company	300 Aberdeen Road	Hampton	VA	23661	757-838-7778
Haynes Small Engine Shop	1709 Howlett St	Hillsville	VA	23434	276-728-0900
B & B Appliance & Lawn Equipment	71 Lawson Road #C	Leesburg	VA	20175	703-777-1093
Phillips Tool Repair	2026 Chamberlayne Ave.	Richmond	VA	23222	804-321-6007
Pressure Works Inc	1704 Roseneath Rd	Richmond	VA	23230	804-358-1129
ET Brown Co	9650 Cherokee Rd	Richmond	VA	23235	804-320-1151
<b>Washington</b>			<b>WA</b>		
Rental's Etc. Inc.	700 S Tower Street	Centralia	WA	98531	360-736-8257
Westech Services	2128 Broadway	Evertt	WA	98201	425-348-0348
American Spray Equipment	7405 S 212th St #115	Kent	WA	98032	253-395-9009
Forrest Paint	1741 S. Central Ave.	Kent	WA	98032	253-854-6372
Rudd Company, Inc.	4909 11th Ave. N.W.	Seattle	WA	98107	206-505-6725
Universal Repair	1611 Boylston Ave.	Seattle	WA	98122	206-322-2726
Spokane Pump	3626 E. Trent	Spokane	WA	99202	509-535-9771
Power Tool Service	1902 E Mission	Spokane	WA	99202	509-535-1754
Tap Tool	1401 52nd Ave E	Tacoma	WA	98424	253-922-5787
BJ's Paint N' Place, Inc*	6528 A Capitol Blvd S	Tumwater	WA	98501	360-943-3232
Industrial Hydraulics	2815 37th Ave Sw Suite 100	Tumwater	WA	98512	360-956-7070
Mac's Spray Systems	6311 NE St John	Vancouver	WA	98663	360-695-8838
Herb's Rent-All & Sales*	927 S Wenatchee Ave	Wenatchee	WA	98801	509-662-7151
Industrial Electric	1512 Walla Walla	Wenatchee	WA	98801	509-663-4756
Tri-State Supply	205 So 4th Ave	Yakima	WA	98902	509-576-0370
<b>Wisconsin</b>			<b>WI</b>		
Balanced Automotive DBA Qtly Pump	1629 N Jargo Rd	Deerfield	WI	53531	608-764-5965
Badger Spray Repair	6617 Watts Rd	Madison	WI	53719	608-278-8893
Ken's Economy Sales	8887 Highway A	Marshfield	WI	54449	715-676-2143
Steinkellner Dec. Center, Inc.	8834 W North Ave	Milwaukee	WI	53226	414-778-0580
American Power Equipment	29110 Evergreen Dr	Waterford	WI	53185	262-534-4785
Hallman Lindsay Paint	7326 W. North Ave.	Wauwatosa	WI	53213	414-453-1972
Badger Spray Repair	7326 West North Ave	Wauwatosa	WI	53213	414-257-0940
Sherwin Williams 3515 Mautz Paint	11628 N Dixon St	West Allis	WI	53214	414-257-1110
<b>West Virginia</b>			<b>WV</b>		
Air-Tech Tool Service INC	325 City Ave	Beckley	WV	25801	304-253-6799
Gentek Repair	Rt 3 Box 181	Romance	WV	25248	304-988-1316
Mac's Garage	1806 Kanawha Terrace	St. Albans	WV	25177	304-727-6031
<b>Wyoming</b>			<b>WY</b>		
B & B Services	699 N 5th Ave	Casper	WY	82604	307-235-3539
Hartsook Equipment	1640 N 18th St	Cheyenne	WY	82501	307-634-4489
Louie's Small Engine Repair	503 Green St	Riverton	WY	82501	307-856-1787
<b>Canada</b>					
Tom Moody Co.	10565 116 Street	Edmonton	AB	T5H3L8	780-428-0265
Rapid Tool Repair	28-7621 Vantage Way	Delta	BC	V4G 1A6	604-940-8603
Active Air Industries	#105-19789 92 A Ave	Langley	BC	V1M3B3	604-888-5668
Solar Electric Repairs	20A Cliff St	Nanaimo	BC	V9R5E5	250-753-1731
AC Motor Electric	259 Okanagan Ave East	Penticton	BC	V2A3J8	250-493-1440
A & D Power Equipment	2218 S Nicholson St	Prince George	BC	V2N 1V8	250-562-2226
A & C Equipment	2615 Turner St	Victoria	BC	J8T 4T8	250-386-5331
Rode Industrial Systems	1370 Clifton Street	Winnipeg	MB	R3E 2V2	204-982-8900
Northern Machine & Repair	526 Welham Rd Unit 6	Barrie	ON	I5n8z7	705-734-1073
All Spray Equipment	95 Snow Ave	Blenheim	ON	N0P1A0	519-358-6149
Active Tool Repair	955 Barton St E	Hamilton	ON	L8L 3C4	905-545-7646
Murrays Tool Repair	1190 2nd Ave	Owen Sound	ON	N4K 2H9	519-376-2495
A.C. Jenkins Electric	1188 Frances Street	London	ON	N5W2M1	519-451-4020
Advanced Spraying Equipment	1295 Eglinton Ave. E. #18	Mississauga	ON	L4W3E6	905-624-7400
Basil Fearn LTD	51 Clyde Ave	Mount Pearl	NF	A1N 4R8	709-747-8495
Mini-Tune Small Engine Repair	1801 Broadway Ave	Saskatoon	SK	S7H2B6	306-343-5610
Ted's Power Tool Repair	426 - 44th Street East	Saskatoon	SK	S7K0W1	306-934-6155
Choquette Cks	900 Pierre Bertrand Blvd Suite 220	Quebec City	QC	G1M 3K2	418-681-3944
Equipment Lavigne	3095 Des Ormerax	Montreal	QU	H1L 4Y1	514-351-6004
<b>Mexico</b>					
Herramientas Lepe	AV Constitucon Sur #1018. LOC 25 Zona Centro RFC: LECM 710628-FSO RFC: LECM 710628-FSO	Tijuana BC CP		22000	011-5266-84-5275

# Warranty • Garantie • Garantía

## LIMITED WARRANTY AIRLESS PAINT SPRAY EQUIPMENT

This product, manufactured by Wagner Spray Tech Corporation (Wagner), is warranted to the original retail purchaser against defects in material and workmanship for one year from date of purchase.

This warranty does not cover damage resulting from improper use, accidents, user's negligence or normal wear. This warranty does not cover any defects or damages caused by service or repair performed by anyone other than a Wagner Authorized Service Center. This warranty does not apply to accessories.

ANY IMPLIED WARRANTY OF MERCHANTABILITY OR FITNESS FOR A PARTICULAR PURPOSE IS LIMITED TO ONE YEAR FROM DATE OF PURCHASE.

WAGNER SHALL NOT IN ANY EVENT BE LIABLE FOR ANY INCIDENTAL OR CONSEQUENTIAL DAMAGES OF ANY KIND, WHETHER FROM BREACH OF THIS WARRANTY OR ANY OTHER REASON.

If any product is defective in material and/or workmanship during the applicable warranty period, return it with proof of purchase, transportation prepaid to any Wagner Authorized Service Center. (Service Center listing is enclosed with this product.) Wagner's Authorized Service Center will either repair or replace the product (at Wagner's option) and return it to you, postage prepaid.

**SOME STATES DO NOT ALLOW LIMITATIONS ON HOW LONG AN IMPLIED WARRANTY LASTS OR THE EXCLUSION OF INCIDENTAL OR CONSEQUENTIAL DAMAGES, SO THE ABOVE LIMITATION AND EXCLUSION MAY NOT APPLY TO YOU.**

**THIS WARRANTY GIVES YOU SPECIFIC LEGAL RIGHTS, AND YOU MAY ALSO HAVE OTHER RIGHTS WHICH VARY FROM STATE TO STATE.**

## GARANTIE LIMITÉE MATÉRIEL DE PULVÉRISATION DE PEINTURE SANS AIR

Ce produit, fabriqué par Wagner Spray Tech Corporation (Wagner), est garanti, au bénéfice de l'acheteur au détail d'origine, contre tout vice de matières et toute malfaçon pour un an à compter de la date d'achat.

La présente garantie ne s'applique pas aux dégâts entraînés par une utilisation incorrecte, par la négligence de l'utilisateur ou par l'usure normale. La présente garantie ne s'applique pas non plus aux défauts ou dommages résultant de l'entretien ou de la réparation que fait une personne quelconque qui ne soit pas membre d'un centre d'entretien autorisé pour les produits Wagner. La présente garantie ne s'applique pas aux accessoires.

TOUTE GARANTIE IMPLICITE DE QUALITÉ MARCHANDE OU D'ADAPTATION À UN USAGE PARTICULIER EST LIMITÉE À UNE PÉRIODE DE 30 JOURS POUR UNE UTILISATION PROFESSIONNELLE OU DE LOCATION ET D'UNE ANNÉE POUR L'UTILISATION DOMESTIQUE, À COMPTER DE LA DATE D'ACHAT.

TOUTE GARANTIE IMPLICITE DE VENDABILITÉ OU DE CONVENANCE À UNE DESTINATION PARTICULIÈRE EST LIMITÉE À UN AN À COMPTER DE LA DATE D'ACHAT.

Si un produit est défectueux en ce qui concerne les matériaux ou l'exécution pendant la période de garantie applicable, vous devez le retourner, avec une preuve d'achat et frais de port payés, à n'importe quel centre d'entretien autorisé pour les produits Wagner. (Une liste de ces centres d'entretien est jointe à ce produit.) Le centre d'entretien autorisé pour les produits Wagner réparera ou remplacera le produit (à la discrétion de Wagner) et vous le retournera par la poste, avec frais de port payés.

**CERTAINES PROVINCES INTERDISSENT LES RESTRICTIONS SUR LA DURÉE D'UNE GARANTIE IMPLICITE OU L'EXCLUSION DES DOMMAGES ACCESSOIRES OU INDIRECTS. IL SE PEUT DONC QUE LA RESTRICTION ET L'EXCLUSION ÉNONCÉES CI-DESSUS NE S'APPLIQUENT PAS À VOUS. LE PRÉSENTE GARANTIE VOUS ACCORDE DES DROITS JURIDIQUES SPÉCIFIQUES, ET VOUS AVEZ PEUT-ÊTRE D'AUTRES DROITS, QUI PEUVENT VARIER D'UNE PROVINCE À L'AUTRE.**

## GARANTÍA LIMITADA EQUIPO DE ATOMIZACIÓN DE PINTURA SIN AIRE

Este producto, fabricado por Wagner Spray Tech Corporation (Wagner), está garantizado ante el comprador original contra defectos de materiales y mano de obra durante un año contado a partir de la fecha de compra.

Esta garantía no cubre los daños que sean resultado de un uso inapropiado, accidentes, negligencia del usuario o un desgaste normal. Esta garantía no cubre ningún defecto o daño que haya sido causado por los servicios o reparaciones llevadas a cabo por alguien que no sea un técnico del Centro de Servicio Autorizado de Wagner. Esta garantía no es válida para ningún accesorio.

CUALQUIER GARANTIA IMPLICITA DE COMERCIALIZACION O IDONEIDAD PARA CUALQUIER PROPOSITO EN PARTICULAR QUEDA LIMITADA A UN AÑO A PARTIR DE LA FECHA DE COMPRA.

WAGNER NO SERÁ EN NINGÚN CASO RESPONSABLE DE NINGÚN DAÑO INCIDENTAL O DE CONSECUENCIA DE NINGUNA CLASE, QUE RESULTE DE VIOLAR ESTA GARANTÍA O POR CUALQUIER OTRA RAZÓN.

Si algún producto llegara a tener defectos de material y/o mano de obra durante el período de validez de la garantía, devuélvalo junto con el comprobante de compra y flete previamente pagado, a cualquier Centro de Servicio Autorizado de Wagner. (La lista de Centros de Servicio viene adjunta con este producto.) El Centro de Servicio Autorizado de Wagner reparará o reemplazará el producto (según la opción de Wagner) y se lo devolverá, con porte previamente pagado.

**ALGUNOS ESTADOS NO PERMITEN LIMITACIONES EN CUANTO A LA DURACIÓN DE UNA GARANTÍA IMPLÍCITA O LA EXCLUSIÓN DE DAÑOS INCIDENTALES O DE CONSECUENCIA, DE MANERA QUE LA LIMITACIÓN Y EXCLUSIÓN ANTERIORES PODRÍAN NO SER VÁLIDAS PARA USTED.**

**ESTA GARANTÍA LE CONCEDE DERECHOS LEGALES ESPECÍFICOS, PERO USTED PODRÍA TENER DERECHO A OTROS, LOS CUALES VARÍAN DE UN ESTADO A OTRO.**

Wagner Spray Tech Corporation  
1770 Fernbrook Lane  
Plymouth, Minnesota 55447  
Telephone 1-800-328-8251

Copyright © 2007 Wagner Spray Tech Corporation. All rights reserved, including right of reproduction in whole or in part, in any form.

U.S. Patent Nos. 6,981,852 6,933,634  
7,018,181 Other patents pending