

How to Wash

Covers

The Top, Middle, and Bottom covers cannot be washed in a household washing machine. Please wash with commercial cleaning (wet cleaning). When cleaning the mattress cover (top, middle, and bottom), unzip the covers, separate them into the three parts, and wash each side of the covers separately to ensure thorough cleaning.

Covers for airfiber blocks & Soft layers

Washing Instructions

- The cover and soft layers can be dry cleaned or washed in a household washing machine. For the cover, use a maximum temperature of 30° C/86° F, and for the soft layers, use a maximum temperature of 40° C/105° F.
- Follow the care label instructions located inside the cover when washing.
- We recommend using the "blanket course" or a similar washing cycle.
- Do not use bleach or fabric softener.

CAUTIONS

- Before washing, please consult the instruction manual of your washing machine to ensure it can accommodate the size of the mattress covers or soft layers, or any similarly sized items.
- Wash the cover separately without mixing it with other laundry.
- Fold the cover and wash it using the washing method for large items in the washing machine.
- Inner cover cannot be washed.

Drying Instructions

- Dry the mattress covers or soft layers in the shade in a well-ventilated area.
- Do not iron them.
- Avoid using a tumble dryer.
- Refrain from prolonged spin-drying to prevent issues such as wrinkles, disordered fur, color problems, or blowout of stuffing.
- Dry them immediately after spin-drying to prevent wrinkles, odors, and other potential problems.

airfiber®

- Wash by hand using lukewarm water, with a maximum temperature of 40°C/105°F.
- Use a gentle soap, such as dish soap, to clean the airfiber®.
- If desired, sterilize the airfiber® by using a diluted alcohol solution mixed with water.
- Do not use a washing machine.
- Do not use a dryer for drying the airfiber® as it may cause damage. Do not attempt to dry clean the airfiber®.
- Dry in the shade in a well-ventilated area.

Product Features

The 70 series stands as the most luxurious mattress in the history of airweave. While retaining airweave's renowned features of firm body support and effortless turning, the 70 series model sets a new standard of sophistication.

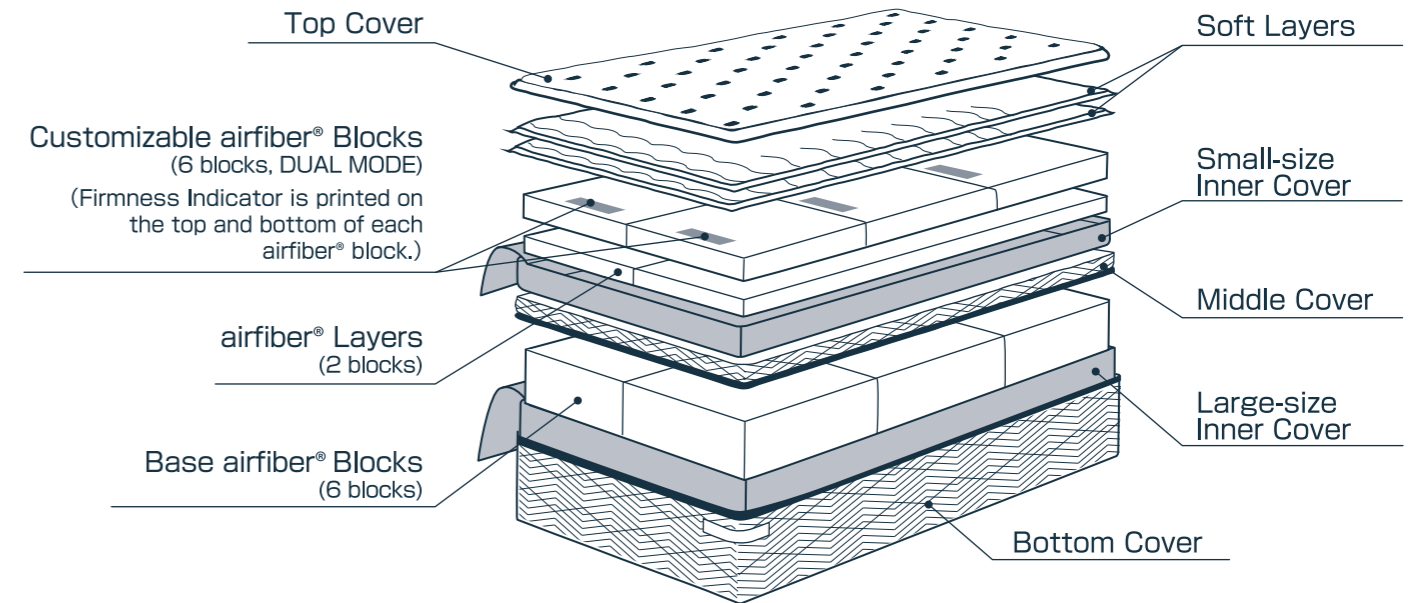

Contents

Make sure the following items are ready before assembly.

BOX 1

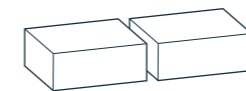

Base airfiber® Blocks (2)

BOX 2

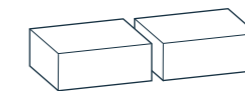

Base airfiber® Blocks (2)

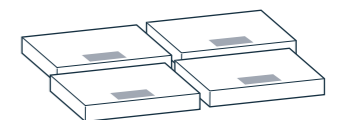

Customizable airfiber® Blocks (4)

BOX 3

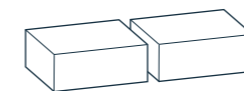

Base airfiber® Blocks (2)

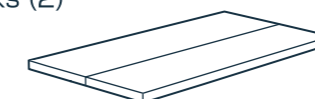

airfiber® Layers (2)

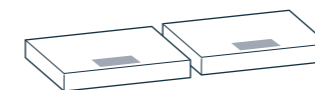

Customizable airfiber® Blocks (2)

BOX 4

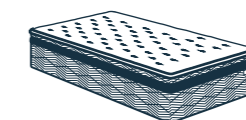

Cover (1)

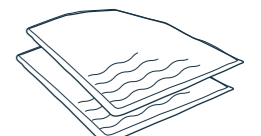

Soft Layers (2)



Large-size Inner Cover (1)



Small-size Inner Cover (1)

Assembly

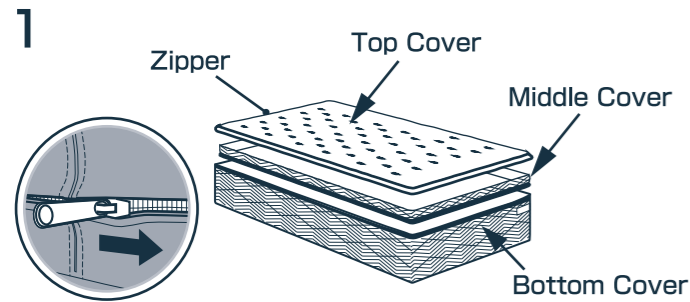

To separate the mattress into three parts, unzip the top and bottom covers completely from the middle cover.

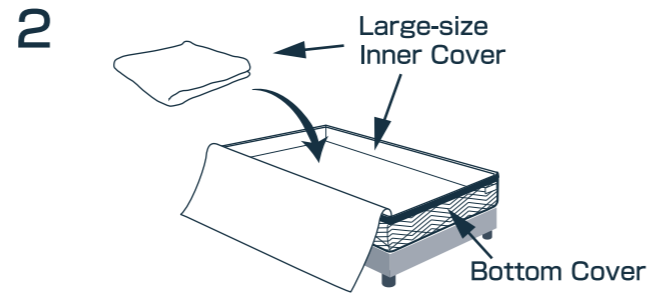

Place the bottom cover on your bed frame, ensuring it is smooth and wrinkle-free before proceeding with the setup. Unzip the large-size inner cover and evenly spread it on the top of the outer cover.

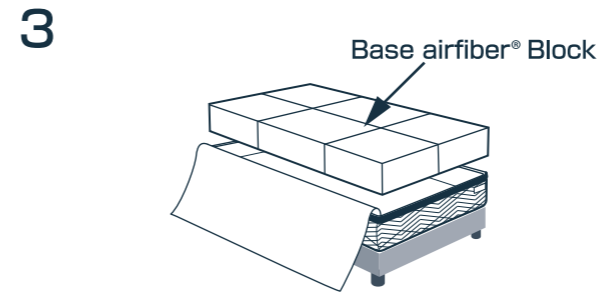

Place the base airfiber® blocks into the large-size inner cover. Make sure the base airfiber® blocks are tightly fitted into each corner of the cover and zip up the inner cover carefully.

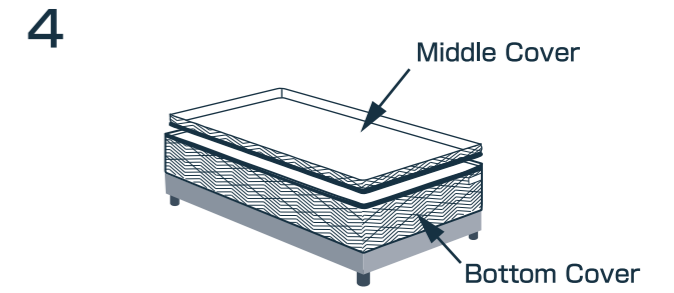

Place the middle cover on top of the large-size inner cover, ensuring that the surface of the middle cover is smooth and wrinkle-free. Zip the middle cover and bottom cover together securely.

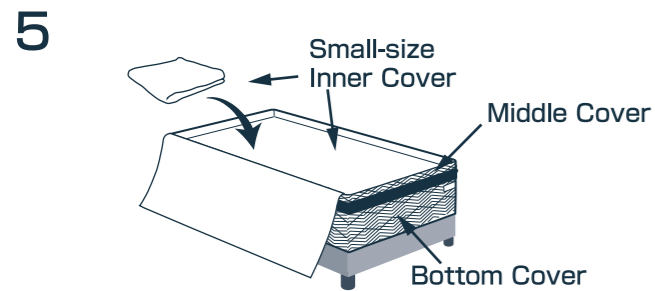

Unzip the small-size inner cover and evenly spread it on the top of the middle cover.

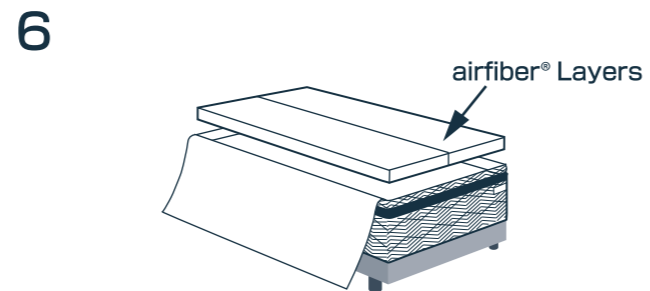

Place the airfiber® layers onto the inner cover. For a more softer experience, place the airfiber layers on top of the customizable airfiber blocks.

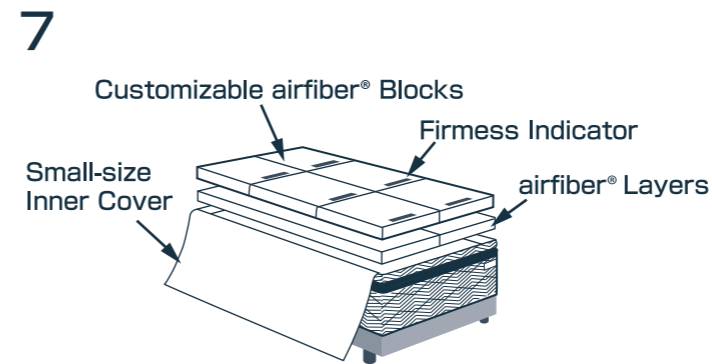

Position the customizable airfiber® blocks onto the airfiber® layers and zip up the inner cover carefully. Each customizable airfiber® block features distinct firmness levels on both sides. Feel free to flip and re-arrange the customizable airfiber® blocks according to your personal preferences or conveniently utilize our online measurement tool (Scan QR Code located on the bottom left of the page) for assistance.

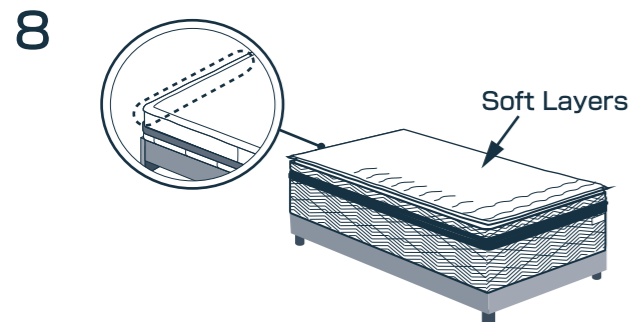

Place the optional soft layers on top of the inner cover. This step allows you to add additional softness, if desired.

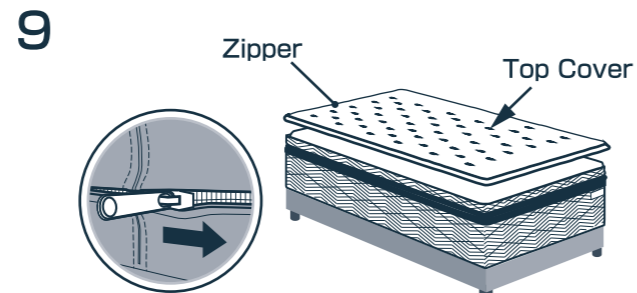

Place the top cover on the assembled layers and zip up the entire product. Ensure you zip carefully, applying minimal pressure to the mattress to prevent any potential damage to the airfiber® material.

Our Five Key airfiber® Configurations

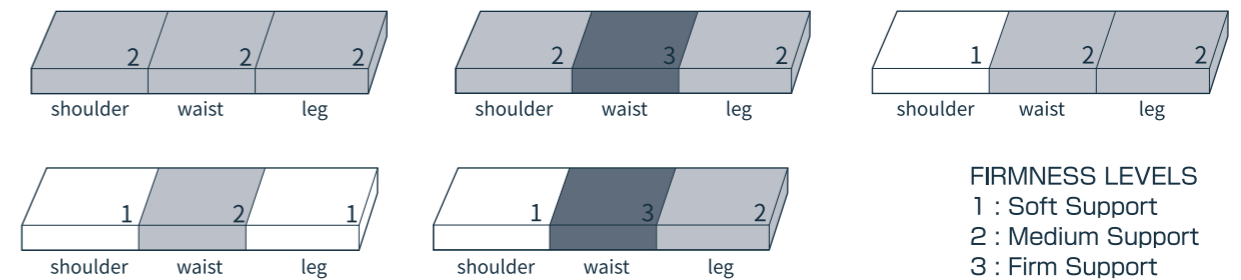

For assistance on finding your recommended pattern using our measurement technology, please scan the QR code with your smartphone to access the website.



Precautions

Initial Use

During the initial period of use, it is common to experience some muscle discomfort as your spine adjusts to proper alignment and your body familiarizes itself with new bedding. Typically, this discomfort improves within 2 to 4 weeks as you adapt. To enhance your comfort during this adjustment period, we recommend placing towels and blankets on the mattress.

For Long and Comfortable use

This product should be placed on the bed frame. It is recommended to use it with bed sheets or mattress pad. This will prevent damages and stains, and ensure a long life of use.

CAUTIONS

- Exercise caution when opening and closing the zipper to avoid pinching the fabric or tag inside.
- In the event of pilling or snagging on the cover, do not pull. Instead, use scissors to carefully cut any affected areas.
- Do not use airfiber® just by itself.
- Smoking on the mattress is strictly prohibited due to the risk of fire.
- If you experience any discomfort or notice any issues with your body while using this product, please discontinue use.
- Keep the mattress away from fire or heat-generating equipment.
- Avoid standing or jumping on the mattress to maintain its integrity and longevity.

For more information on your mattress visit our frequently asked questions page at airweave.com/faq