

### USB to UART

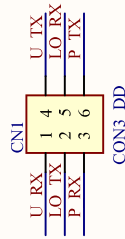

### Uart Chose

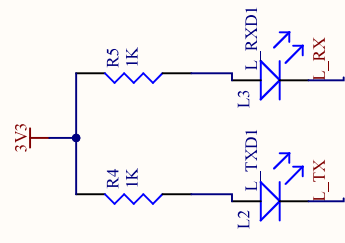
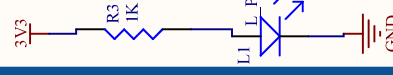
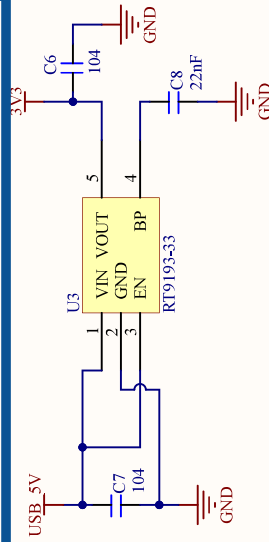

### RXD TXD Indicator light

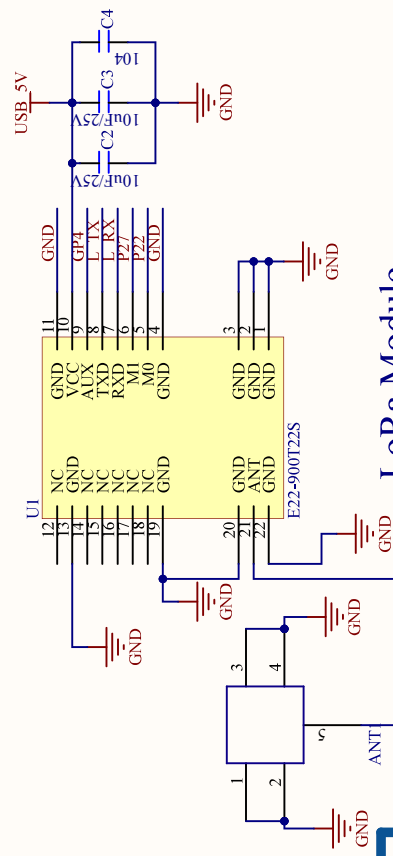
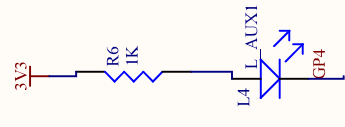

### LoRa Module

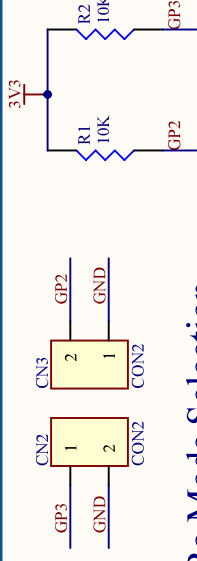

### LoRa Mode Selection

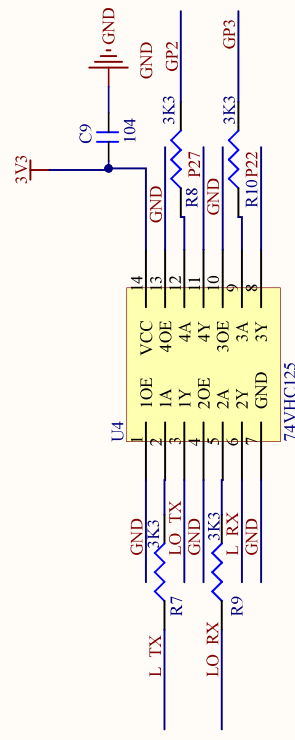

### Voltage Level Switch

## PICO LORA EXPANSION

Size: A4	Revision: <b>V1.0</b>	Sheet: <b>1/2</b>
Date: 28-03-2022	Time: 15:15:27	DrawnBy: Deepak Singh



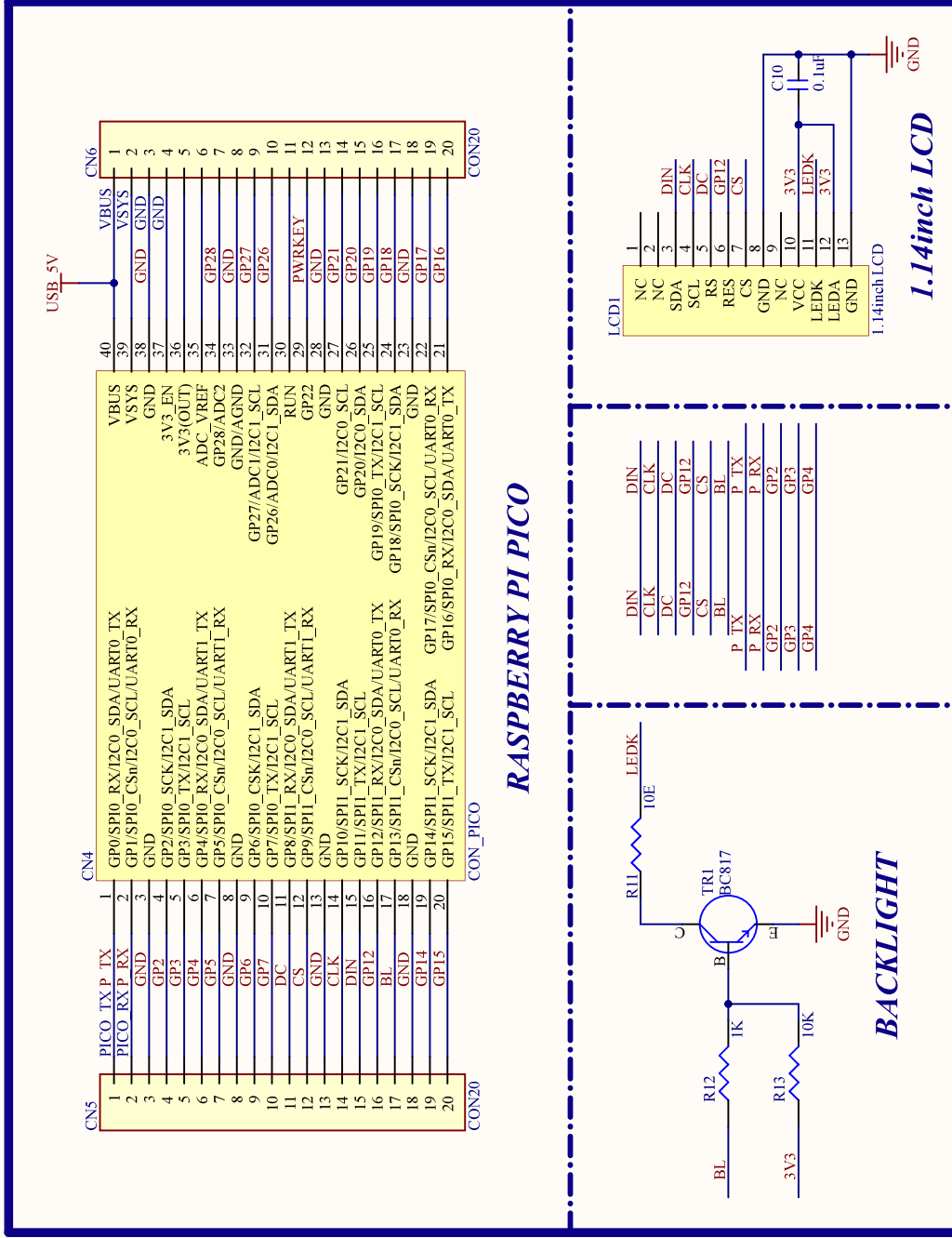

PICO LORA EXPANSION

Size: A4	Revision: V1.0	Sheet: 2/2	SB Component Ltd. Kemp House, 152-160, London EC1Y 2NX.
Date: 28-03-2022	Time: 15:15:28	DrawnBy: Deepak Singh	

