

ECOFLOW

LFP Battery | User Manual

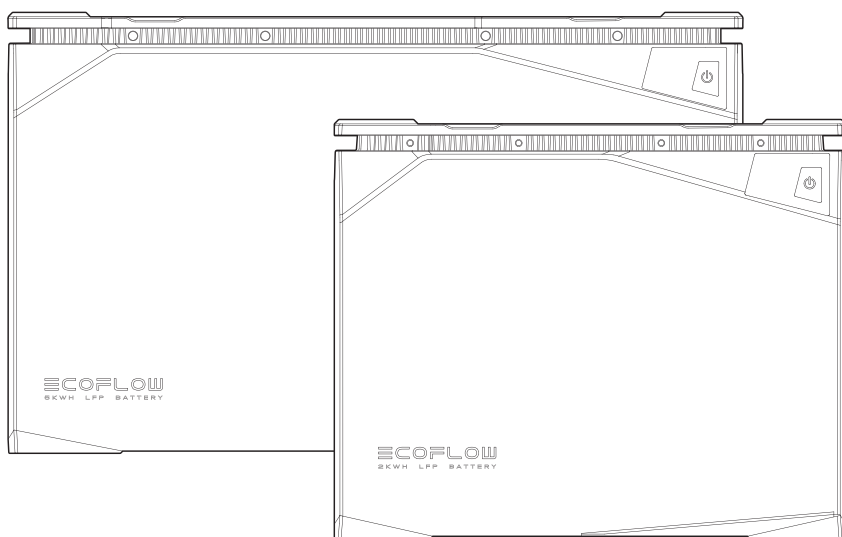

Disclaimer

Please read this User Manual and ensure you understand it fully before using the product. Please keep this User Manual properly for future reference. Any incorrect usage of this product may cause severe injury to the user or others, damage to the product, or loss of property. By using this product, the user will be deemed as having understood, recognized, and accepted all the terms and contents of this User Manual, and will be responsible for any incorrect usage and all consequences arising therefrom. EcoFlow hereby disclaims any liability for any losses due to the user's failure to use the product according to the User Manual.

In compliance with laws and regulations, EcoFlow shall have the final right to interpret this document and all related documents for this product. Any update, revision, or termination of the contents thereof, if necessary, shall be made without prior notice, and users may visit EcoFlow official website for the latest information of the product.

1. Safety Instructions

1.1 Prohibitions

1. It is strictly prohibited to place this battery near heat sources, such as fire or heating furnace.
2. It is strictly prohibited to allow this battery to contact with any liquid. Do not immerse this battery in water. Do not use this battery in rainy, damp, or wet environment.
3. It is prohibited to use this battery in strong static or strong magnetic field environment.
4. It is prohibited to disassemble this battery in any way or puncture this battery with sharp objects.
5. It is prohibited to connect the positive and negative terminals of the battery directly with wires or any metal objects.
6. It is prohibited to dismantle or replace the battery cells.
7. It is prohibited to stack heavy objects other than another EcoFlow LFP battery on top of this battery.
8. It is prohibited to place this battery in an unventilated or dusty environment.

1.2 General Notices

1. Beware when using unofficial components or accessories. Please visit authorized EcoFlow channels for official components and accessories information.
2. If the battery is compromised or battery cells are exposed, do not attempt to repair it yourself. Please have it inspected and repaired by authorized EcoFlow repair centers.
3. In case of accidental leakage of chemicals inside this battery, do not touch or inhale. In case of accidental contact with skin or eyes, wash with plenty of clean water and seek medical treatment immediately.
4. Do not operate this battery while wearing metal objects such as watch, necklace, and bracelet to avoid causing accidental short circuits. If this battery catches fire, immediately use fire extinguisher or fire fighting equipment water or mist, sand, fire blanket, dry powder fire extinguisher, carbon dioxide fire extinguisher.
5. When using this battery for the first time, if the battery appears broken or has abnormal smell, do not continue to use this battery and return it to sellers.
6. If this battery accidentally falls into water during use, place it in a safe, open area and stay away from this battery until it is completely dry, and this battery should not be reused and should be disposed properly in accordance with the disposal methods in Section 8.2 of this User Manual.
7. If the battery charging exceeds regular charging time, charging should be stopped. Overcharge may cause the battery to overheat, to smoke and deform, or to combust.
8. This battery should be kept out of the reach of children and pets.

1.3 Handling Precautions

1. When handling this battery, use the non-slip metal handles from this battery for proper handling.
2. When handling this battery, be sure to secure it properly and keep it in a flat position.
3. Please handle with care.

2. EcoFlow App

Control, monitor, and customize your EcoFlow Modular Power System wirelessly with the EcoFlow App. Download at: <https://download.ecoflow.com/app>

Privacy Policy

By using EcoFlow Products, Applications and Services, you consent to the EcoFlow Term of Use and Privacy Policy, which you can access via the "About" section of the "User" page on the EcoFlow App or on the official EcoFlow website at <https://www.ecoflow.com/policy/terms-of-use> and <https://www.ecoflow.com/policy/privacy-policy>

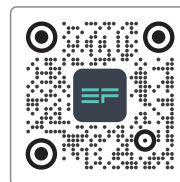

EcoFlow app

3. What's in the Box

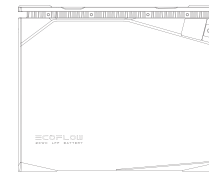

LFP Battery

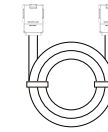

Battery Cable



User Manual and
Warranty Card

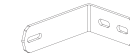

Wall Mounting
Clamp



Screws

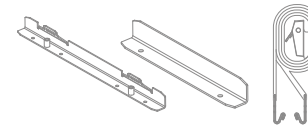

Mounting Strap

4. Battery Specifications

4.1 General Information

	5KWh LFP Battery	2KWh LFP Battery
Net weight	Approx. 89.5 lbs(40.6 kg)	Approx. 37.7 lbs(17.1 kg)
Dimensions	19.7 x 10.2 x 11.8 in 500 x 260 x 300 mm	13.7 x 7.8 x 11.2 in 348 x 198 x 285 mm
Nominal Capacity	5120Wh(100Ah)	2048Wh(40Ah)
Nominal Voltage	51.2V	51.2V
Configuration	16S1P	16S2P
Charging Cut-off Voltage	57.6V	57.6V
Discharging Cut-off Voltage	40V	40V
Max Continued Charging Current	80A	32A
Max Continued Discharge current	100A	80A
Battery Chemistry	LiFePO ₄	LiFePO ₄
Cycle life	3,500 cycles to 80% capacity	3,000 cycles to 80% capacity
IP Rating	IP54	IP54

4.2 Cycle Curve

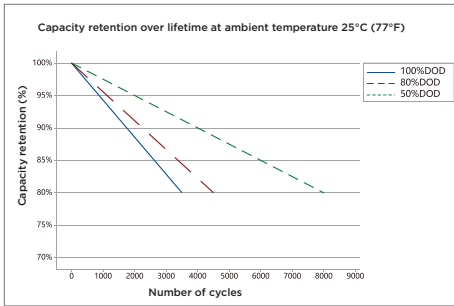

5kWh LFP Battery

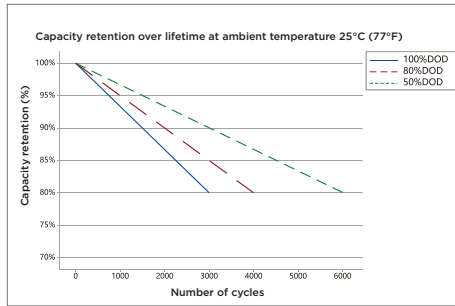

2kWh LFP Battery

*To obtain longer battery life, it is recommended to use partial charging and discharging, i.e. with a depth of discharge (DOD) of less than 80%. The DOD is the ratio of the amount of battery discharge to the rated capacity of the battery.

4.3 Operating Temperature

	5kWh LFP Battery	2kWh LFP Battery
Discharge Temperature Range	-20°C-50°C (-4°F-122°F)	-20°C-50°C (-4°F-122°F)
Charge Temperature Range	-20°C-50°C (-4°F-122°F) (auto-heating below 0°C (32°F))	-20°C-50°C (-4°F-122°F) (auto-heating below 0°C (32°F))
Humidity Range	Max. 90%RH	Max. 90%RH
Storage Temperature	-20°C-50°C (-4°F-122°F) (optimal 15°C-25°C (59°F-77°F))	-20°C-50°C (-4°F-122°F) (optimal 15°C-25°C (59°F-77°F))

*Whether this battery can be charged or discharged depends on actual temperature of the battery.
*This battery will activate auto-heating function when charging temperature falls below 0°C (32°F).

5. Battery Overview

5.1 Introduction to Battery

There are two types of EcoFlow LFP Battery, 5kWh LFP Battery and 2kWh LFP Battery, both of which use the safest and most reliable type of lithium iron phosphate battery cell (LiFePO₄ or LFP). The nominal voltage of a single LFP cell is 3.2V. The 5kWh LFP battery consists of 16 cells (100AH each cell) in 16S1P and the 2kWh LFP battery consists of 32 cells (20AH each cell) in 16S2P. Nominal voltage of both batteries is 16x3.2V=51.2V.

Both batteries have built-in battery management system, which keeps the battery system operating in a reasonable condition at all time and extends the battery service life.

The battery has a built-in auto-heating system to ensure that the battery can be charged safely and quickly at -20°C-50°C (-4°F-122°F).

5.2 EcoFlow Power Kits

The EcoFlow Power Kits consist of the EcoFlow Power Hub, LFP Battery, AC/DC Smart Distribution Panel, Power Kit Console, Rigid/Flexible/Foldable Solar Panel, and Smart Generator.

The Modular Power System aims to meet the needs of customers in off-grid scenarios such as caravans, off-grid build, recreational marine, and home backup.

The Modular Power System is extremely easy to install straight out of the box. Using 48V battery system significantly reduces the gauge and weight of battery cables, reducing wiring cost and increasing safety.

The system's power consumption can be monitored anytime and anywhere via EcoFlow App.

The Modular Power System supports multiple charging methods, including solar charging, alternator charging, smart generator charging, and AC charging. It is capable of outputting 12V or 24V DC and 120V AC (according to local standards) via the AC/DC Smart Distribution Panel, allowing it to power most AC and DC devices.

Caravan & Recreational Marine

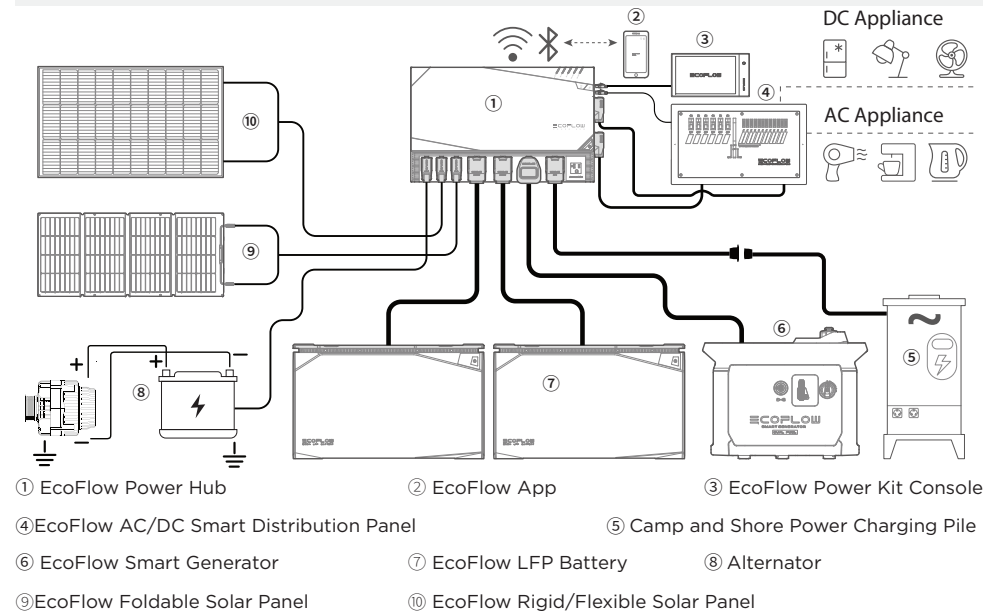

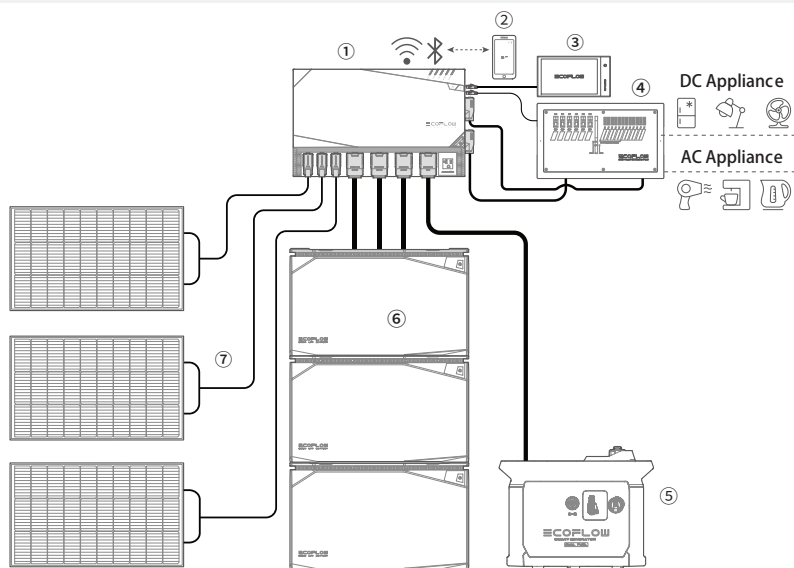

- ① EcoFlow Power Hub
- ② EcoFlow App
- ③ EcoFlow Power Kit Console
- ④ EcoFlow AC/DC Smart Distribution Panel
- ⑤ EcoFlow Smart Generator
- ⑥ EcoFlow LFP Battery
- ⑦ EcoFlow Rigid Solar Panel

Note: The figure shows the different types of sockets in different countries. It is for reference only, please refer to the actual product.

5.3 Battery Appearance

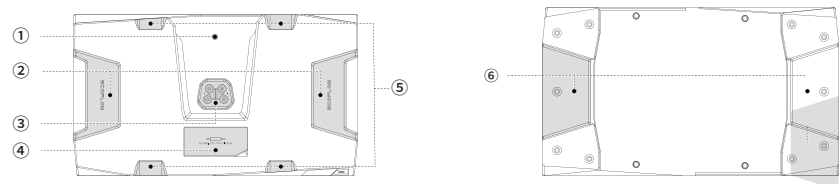

- ① LFP Battery Polarity Adapter Screw Position
- ② Handle
- ③ LFP Battery Male Port
- ④ Fuse Cover
- ⑤ Recess for Strap
- ⑥ Base Stacking Recess

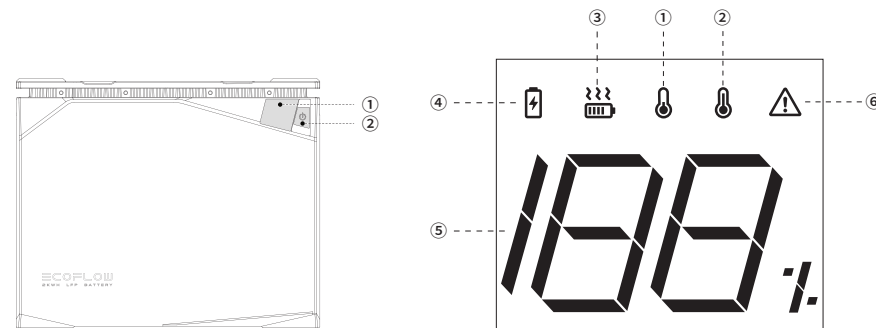

- ① Digital Display
- ② Power On/Off Button

- ① Low Temperature Indicator
 - ② High Temperature Indicator
 - ③ Heating Status Indicator
 - ④ Charging Status Indicator
 - ⑤ Battery Level Indicator
 - ⑥ Protection Warning Indicator
- Protection types include:
 Over-discharge protection
 Overcharge protection
 Overload protection
 Short-circuit protection
 Overcurrent protection, etc.

6. Battery Operation

6.1 Battery On and Off

The battery can be switched on in two ways, via charging or via buttons.

The buttons that can be used to switch on the battery include,

- 1. the battery main power button;
- 2. the EcoFlow Power Kit Console main power button;
- 3. the EcoFlow Power Hub main power button.

The battery can be switched off via,

- 1. the battery main power button;
- 2. the EcoFlow Power Kit Console main power button;
- 3. the EcoFlow Power Hub main power button;
- 4. EcoFlow App.

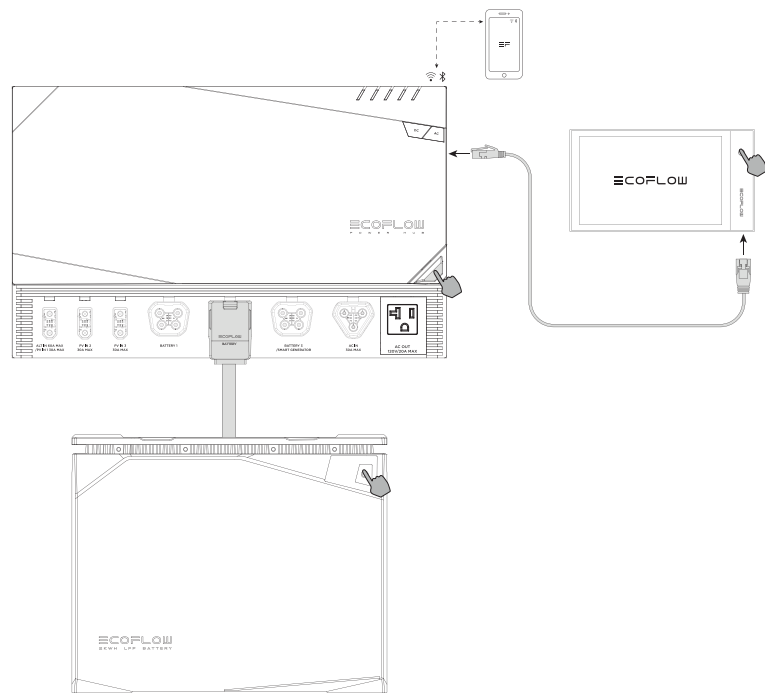

Switching On: Press and hold the power button for 2 seconds. The battery will switch on. Short press the power button to wake up the screen. After switching on, the display will be illuminated and show the remaining battery level.

Switching Off: Press and hold the power button for 3 seconds. The battery will switch off.

Display Sleep: After switching on the battery via the power button, the display will remain lit for 5 mins and will then automatically switch off. To switch the display on or off, short press the power button.

6.2 Charging and Discharging the Battery

6.2.1 Connecting the Battery to the EcoFlow Power Kits

Connect the battery to Power Kits for charging (as follows):

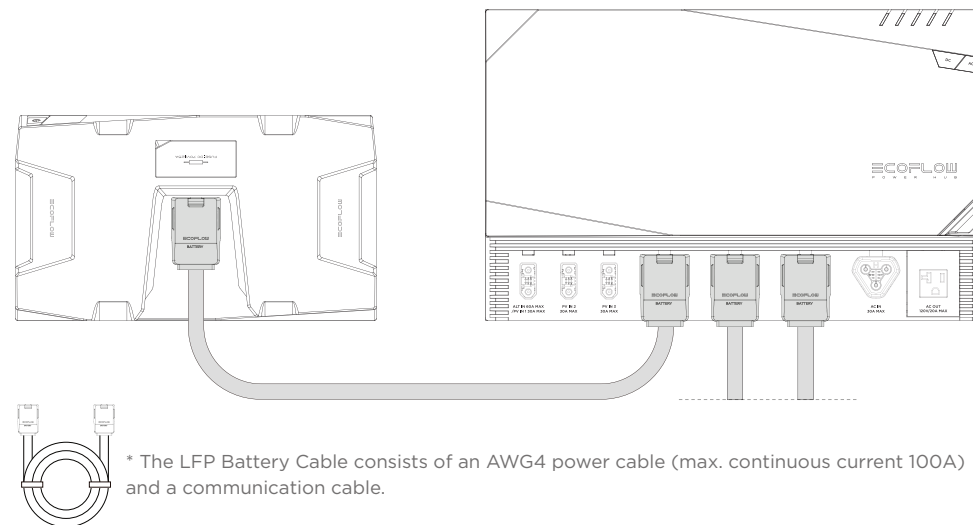

* The LFP Battery Cable consists of an AWG4 power cable (max. continuous current 100A) and a communication cable.

6.2.2 Connecting the Battery to Third-Party Power Systems

EcoFlow LFP Battery is compatible with most commercially available 40V-60V third-party power systems.

The user can monitor the operating status of each battery by connecting the EcoFlow Power Kit Console or EcoFlow Wireless Communication Dongle via the RJ45 port.

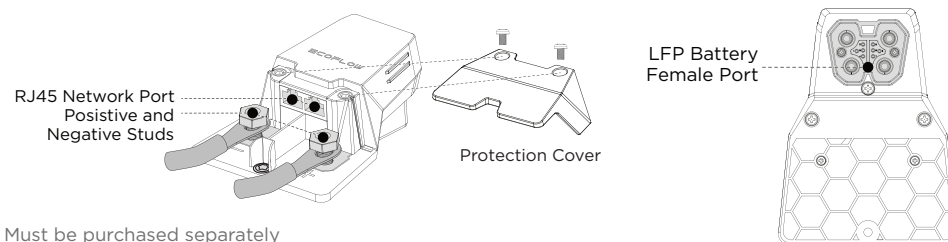

* Must be purchased separately

*EcoFlow Power Kit Console or EcoFlow Wireless Communication Dongle must be purchased separately.

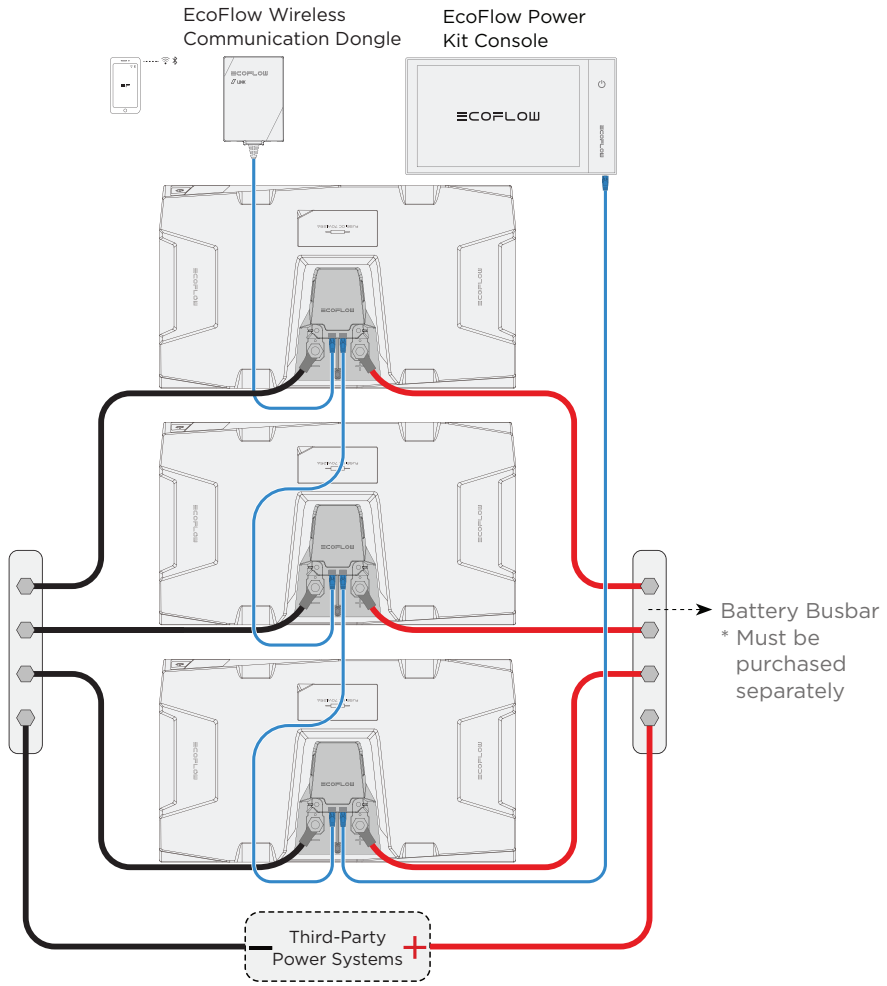

The user should select appropriate connection cable according to the power of the third-party power system and the discharge current of the battery.
 The following table shows the load capacity of different battery connection cables:

Current (A)	Cable size (AWG)
15	14
25	12
40	10
60	8
80	6
100	4
120	2
150	1/0

6.2.3 Battery Pre-Discharging

Battery pre-discharging is a function to limit discharging current temporarily before the battery begins to discharge at high current. This will protect the capacitors of external electrical devices from being damaged by instantaneous high current. Once connected, a current limiting resistor in the battery allows the capacitors of external electrical devices to charge slowly. When the capacitor voltage rises to 90% of the battery voltage, the battery management system removes discharge current limit, and the battery can discharge at high current normally.

6.3 Battery Auto-Heating

6.3.1 Charge Heating

The EcoFlow LFP Battery is built with charge heating function to work in low temperature environment. Charge heating is automatically activated when ambient temperature is below 0°C (32°F) and the battery is in charging mode. The activation sequence is as follows:

1. Charge heating requires charging input ≥ 250 W. When the battery internal temperature rises above 5°C (41°F), the battery can start charging process.
2. When the battery internal temperature rises above 10°C (50°F), charge heating stops, and battery charging continues.

* The charge heating function works in temperature range of -20°C-0°C (-4°F-32°F).

6.3.2 Discharge Heating

The capacity of the battery can be significantly reduced when discharging at high power in low temperature. The EcoFlow LFP Battery is built with discharge heating function to address this situation. Discharge heating function can be activated manually by tapping the discharge heating button in the EcoFlow App as follows:

1. When the battery internal temperature is below 0°C (32°F) and the battery SOC $\geq 70\%$, tap the discharge heating button in the EcoFlow App to activate the discharge heating.
2. When the battery SOC $\leq 50\%$ or the battery internal temperature is higher than 10°C (50°F), the discharge heating function is automatically switched off.

*The discharge heating function works in temperature range of -20°C-0°C (-4°F-32°F).

Why can't the battery automatically activate the discharge heating function?

Unlike charge heating which consumes power from the charging source, discharge heating consumes power from the battery. In low temperature environment, if the battery automatically switches on the discharge heating function, this can lead to frequent depletion of the battery itself.

6.4 Connecting Batteries in Parallel

6.4.1 Charging and Discharging in Parallel

Connecting Batteries in Parallel via the EcoFlow Power Hub

The EcoFlow LFP Battery is a 48V battery system and only supports parallel connection. Up to three EcoFlow LFP Batteries can be connected to the EcoFlow Power Hub at the same time. The EcoFlow LFP Battery Power Cable has preset communication signal, allowing paralleled batteries to communicate with each other.

* Do not use the battery in series as this can potentially damage the battery.

1. Ensure the battery is switched off before connection.
2. Connect the battery to the EcoFlow Power Kits via the EcoFlow LFP Battery Power Cable as shown in the diagram below.

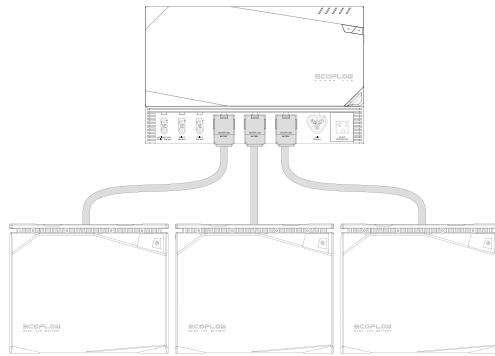

6.5 Battery Management System

The battery is equipped with a battery management system (BMS) and has the following battery protection features:

Battery Discharging Low Voltage Protection	Prevents over-discharging of batteries
Battery Charging High Voltage Protection	Prevents over-charging of batteries
Battery Charging/Discharging Overheat Protection	Prevents high battery temperature
Battery Charging/Discharging Over-Current Protection	Prevents excessive battery current
Battery Equalization Function	Keeps each individual cell in the same condition to ensure the battery is in an optimal condition for use

*When protection is triggered, disconnect the battery and leave it for some time before restarting it.

6.6 Replacing the Fuse

The EcoFlow 5KWh LFP Battery has a built-in DC 70-V/150-A replaceable fuse, while the 2KWh LFP Battery has a built-in DC 70-V/125-A replaceable fuse. Under normal operating conditions, there is no risk of fuse blowing. When an external short circuit occurs and the battery management system is not protected in time, the fuse will blow immediately to protect the battery. When a short circuit occurs and the battery cannot be charged or discharged, the fuse must be replaced. Replacement procedure is as follows:

1. Ensure the battery is switched off, open the fuse cover using a suitable tool, and keep the cover in a safe place.

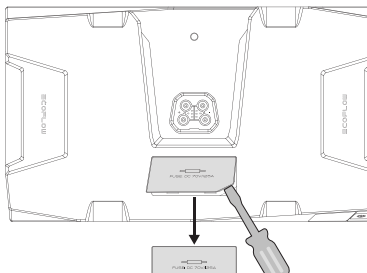

2. Replace the fuse then install the cover back.

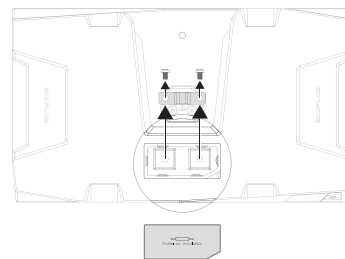

7. Battery Installation

Precautions

1. After opening the battery package, first check the battery and accessories. If the battery is damaged or there is an occurrence of missing parts, please contact the vendor.
 2. Ensure the battery is switched off before installation.
 3. Make sure the electrical specifications of the battery are compatible with the relevant devices and systems.
 4. Keep the battery away from flame and liquid.
- *In case of movement and vibration, such as in caravans and boats, the battery shall be fixed in the following three configurations to prevent the battery from falling over.

LFP Battery Mounting Bracket

* The mounting bracket must be purchased separately

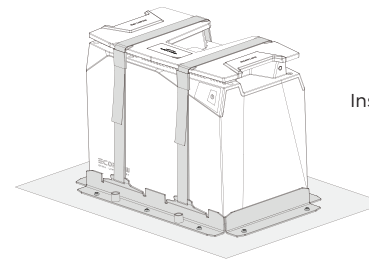

*Battery Mounting Strap

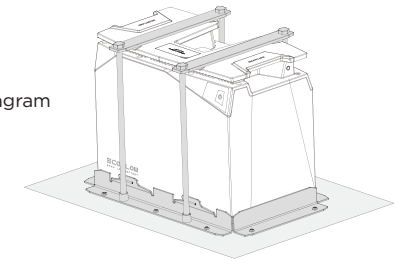

*Battery Mounting Bracket

Installation Diagram

LFP Battery Wall Mounting Clamp

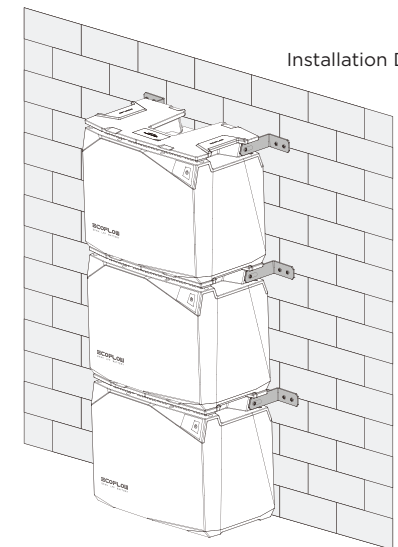
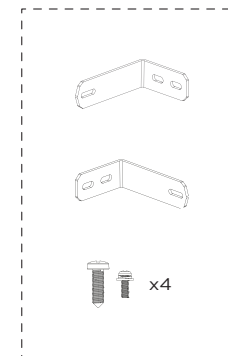

Installation Diagram

8. Battery Maintenance and Disposal



8.1 Maintenance Instructions

1. The battery must be stored in dry and well-ventilated environment. If the storage temperature is too high or too low, this will affect the self-discharge rate of the battery and accelerate the natural aging of the battery. It is therefore recommended to store the battery at a temperature of 20-45°C (68°F-113°F) and stay away from water sources, heat sources, and metal objects.
2. If the battery is not going to be used for a long period of time, it is recommended to be stored intact in a semi-charged state (60% SOC). The battery is recommended to be discharged to 30% and then recharged to 60% every three months.
3. For safety reasons, the battery must not be stored at temperature above 45°C (113°F) or below 20°C (68°F).
4. When the temperature of battery is equal to or below -20°C (-4°F), the battery cannot be used for charging, discharging or heating.
5. To extend the service life of the battery, the battery is recommended to be used at 20°C (68°F) to 45°C (113°F).
6. If the battery level is below 1% after use, it should be charged to 60% before storage. If the battery is left idle for a long period of time with critically low SOC, irreversible damage to the battery cell will occur, reducing the service life of the battery.
7. If the battery SOC is critically low and being left idle for too long, it will enter deep sleep mode and will need to be recharged before it can be used again.

8.2 Disposal

1. If conditions permit, make sure that the battery is completely discharged before placing the battery in the designated battery recycling bin. The battery cells, which contain hazardous chemicals, are strictly prohibited from being placed in an ordinary garbage bin. For relevant details, please comply with the user's local laws and regulations regarding lithium battery recycling and disposal.
2. If the battery cannot be fully discharged due to the fault of the product itself, do not dispose the battery directly. Contact a specialized battery recycling company for further disposal.
3. An over-discharged battery cannot be switched on. Please dispose the battery according to local laws and regulations.

9. Troubleshooting

Description of Error	Error Type	Recovery Methods
 Icon stays on	Low Temperature Indicator	Charging: Automatic recovery after battery temperature above 5°C (41°F) Discharging: Automatic recovery after core temperature above -17°C (1.4°F)
 Icon stays on	High Temperature Indicator	Charging: Automatic recovery after cooling to below 42°C (107°F) Discharging: Automatic recovery after cooling to below 52°C (125°F)
 Icon flashing	Over-Discharge Protection	Battery charging, automatic recovery when SOC > 0%
	Overcharge Protection	Charging stops and recovers automatically after partial consumption of battery power
	Overload Protection	Remove the overpowered device and restart the machine to recover it
	Short-Circuit Protection	Professional inspection recommended to eliminate the cause of the short circuit
	Overcurrent Protection	Remove the overcurrent device and restart the machine to recover it

10. Frequently Asked Questions

1. **What type of battery chemistry is used in this product?**
This product uses high quality lithium iron phosphate.
2. **How do I clean the battery?**
The battery can be wiped with a dry, soft, and clean cloth or tissue.
3. **Are lithium batteries safe?**
The EcoFlow LFP Battery is protected by high-performance BMS and have undergone rigorous testings to ensure safety in use.
4. **Can the 5KWh LFP Battery and 2KWh LFP Battery be used in parallel?**
This is not recommended — when using two models in parallel, the consistency of the batteries cannot be guaranteed, which can lead to shortened life span of the batteries or even a safety hazard.
5. **Can I charge the battery at low temperature?**
Yes, when the battery is being charged at low temperature $-20^{\circ}\text{C} \leq T \leq 0^{\circ}\text{C}$ ($-4^{\circ}\text{F} \leq T \leq 32^{\circ}\text{F}$), the charge heating function is switched on prior to heat the battery before it is charged normally.
6. **Can the battery be used with third-party power systems?**
Yes, the user will need to perform extra wiring for this.
7. **How do I store the battery?**
When storing the battery, first switch it off and then store it in a dry, ventilated place at room temperature and stay away from water sources.
8. **Can the battery be heated when charging with MPPT at ambient temperature below 0°C (32°F)?**
Yes. Depending on the intensity of solar radiation and the power of the solar panel used by the user. It is recommended to connect to at least 400W of solar panel(s).

