

# ECOFLOW

## Smart Home Panel | Installation Manual

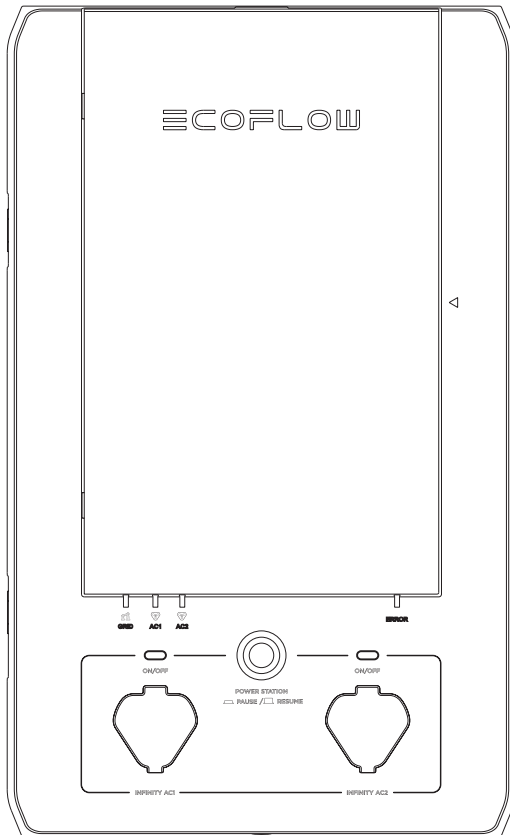

**WARNING**

The EcoFlow Smart Home Panel must be installed by a licensed electrician, who should be familiar with all electrical codes, electrical wiring practices and experience working with home electrical systems. Any accident, damage or personal injury caused by incorrect installation is the sole responsibility of the user.

# CONTENTS

|  |           |
|--|-----------|
| <b>1. Safety Instructions</b>                | <b>1</b>  |
| <b>2. Specifications</b>                     | <b>2</b>  |
| <b>3. Product Details</b>                    |           |
| 3.1 External Features                        | 3         |
| 3.2 Internal Features                        | 4         |
| <b>4. What's in the box</b>                  | <b>6</b>  |
| <b>5. Installation SOP Checklist</b>         | <b>7</b>  |
| <b>6. Installation Steps</b>                 |           |
| 6.1 Preparation                              | 9         |
| 6.2 Installation                             |           |
| 6.2.1 Installing the Relay Module            | 11        |
| 6.2.2 Mounting                               | 13        |
| 6.2.3 Wiring                                 | 15        |
| <b>7. System Commissioning and App Setup</b> | <b>19</b> |
| <b>8. FAQ</b>                                | <b>20</b> |

# 1. Safety Instructions

1. The product must be installed by a licensed electrician.
2. The SHP defaults to grid mode when not powered. For safety, do not access or disconnect any load circuits when there is an internal fault. Power down those loads and contact a licensed electrician or EcoFlow technical support.
3. This product is not intended to be used as a service disconnect. To completely de-energize the product, the user MUST open the upstream breakers as well as physically unplug all DELTA Pros. Failure to do so may present a shock hazard.
4. DO NOT unplug relay modules while SHP is energized, because unplugging the relay module while the SHP is energized may cause damage to the relay modules and SHP.
5. Smart Home Panel by itself does not provide an AFCI (Arc Fault Circuit Interrupter) function. AFCI or GFCI protection may be available with an external AFCI accessory. Consult EcoFlow support for AFCI or GFCI solutions.
6. All upstream breakers feeding SHP should be non-GFCI/AFCI. GFCI and AFCI protection should be downstream of the SHP using GFCI/AFCI breakers or outlets. Follow local electrical codes for AFCI or GFCI installation. An additional accessory panel to aid with installation of AFCI circuits may be available from EcoFlow.
7. Do not use the product near a heat source, such as a fire or furnace. Do not place flammable gases or liquids (e.g. Gasoline) near the device.
8. If there is a loud noise in the relay module, there may be a ground fault downstream of the SHP. The user should clear the fault and replace the relay module before resetting the SHP for normal use.
9. Do not use the SHP if the Short-Circuit Current Rating (SCCR) at the electrical service entrance is above 10kA.
10. Do not install or operate the product outdoors or in damp/wet conditions.
11. Do not install or operate the product in extreme temperatures.
12. Do not use the product if it is damaged or appears to be damaged.
13. Do not connect the relay channels to circuit breakers higher than their current rating. Doing so can result in damage to the relay modules.
14. Adhere to all local and national safety regulations for installation and use.
15. If an overcurrent fault (breaker tripped) occurs, the corresponding relay module must be replaced to ensure safe operation in the future.
16. This product is designed for residential use only.
17. Upstream circuit breakers protect the SHP only in grid mode. Only use circuit breakers with a fault current interruption capability of 10kA or greater, 4ms or 5kA, 8ms.
18. The maximum total current for all input circuits under the grid mode is 120A.

## The SHP MUST be completely de-energized before being serviced

Complete the following to de-energize the SHP

1. Open all connected upstream circuit breakers and make sure the Grid Power Indicators are off.
2. Turn off DELTA Pro(s) from the SHP and ensure the DELTA Pro Power Indicators are off.
3. The alarm will sound if the SHP is energized while the front cover is open. Please ensure that the unit is de-energized and the alarm has stopped.

### DANGER

1. Multiple sources power this equipment.
2. Electrical equipment should be serviced by authorized personnel only.
3. This equipment is not intended to be used as a service disconnect breaker.
4. Upon losing power, this product automatically switches to the power station.
5. This equipment and downstream load can only be de-energized by opening all upstream breakers and physically unplugging all DELTA Pros.

## 2. Specifications

### General Information

|   |  |
|---|--|
| Weight                                  | 18.5 lbs (8.38 kg)                         |
| Dimensions                              | 20x12.2x4.5 in (508x311x115 mm)            |
| Protective class                        | I  |
| Mounting type                           | Wall Mount                                 |
| Standard connector                      | EcoFlow Infinity Port                      |
| Ingress protection                      | IP20                                       |
| Warranty description                    | 5 Years                                    |
| Maximum # of circuits controlled        | 10   |
| Rated system voltage                    | 240V                                       |
| Max total input current                 | 120A                                       |
| Short circuit rating                    | 10kA                                       |
| Rated relay module current              | 6A, 13A, 16A, 20A, 30A                     |
| Rated Max. DELTA Pro input              | 7200W Max (2x3600W)                        |
| DELTA Pro charging power                | 6800W Max (2x3400W)                        |
| Max. connected battery energy           | 21.6 kWh (6x3.6 kWh)                       |
| Operating and storage temperature range | -20°C - 45°C                               |
| Enclosure temperature                   | Less than 65°C                             |
| Touch current                           | <3.5mA a.c. (Under single fault condition) |

### Note

The actual usable capacity may vary according to the variable environment and charging/discharging conversion differences.

# 3. Product Details

## 3.1 External Features

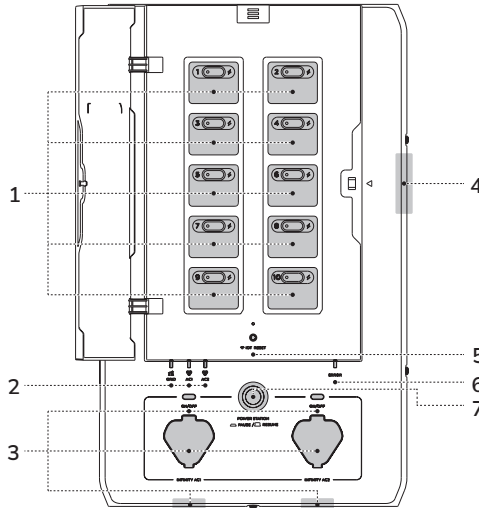

### 1. Load Circuit Control Board

The SHP can be set up to control a total of 10 load circuits, circuits 1, 3, 5, 7, 9 on the left and 2, 4, 6, 8, 10 on the right. There is a button allowing users to manually reset each circuit relay if there has been an overcurrent event on the circuit. An indicator lamp on the button turns red if there is a fault in that circuit.

A lightning bolt indicator for each load circuit is illuminated if that load circuit is energized through one of the sources (grid or power station).

### 2. Grid Indicator and Infinity Port Indicator

There are three energization indicators on the SHP, one for the grid, two for the DELTA Pros. If any of these indicators are illuminated, SHP is energized from that source and, therefore, cannot be opened to be serviced.

### 3. Infinity Port and Enable Button

There are two infinity ports on the SHP, which can be either on the bottom of the SHP (default), or relocated to the front. They connect DELTA Pros to the SHP through the Infinity Cable (one for each DELTA Pro). Once plugged in, SHP and DELTA Pro will try to establish connection through communication and SHP's control circuitry may be powered via DC current from the DELTA pro. Press the enable button located near the infinity port (labeled "AC 1" or "AC2" to make DELTA Pro ready for output.

### 4. Panel Open Alarm System

When the DELTA Pro load circuits are energized, an alarm will sound if the front panel cover is opened. To de-energize the product, all upstream breakers must be opened and both DELTA Pros must be unplugged.

## 5. IOT Reset Button and Indicator

This button can be used to turn on the Bluetooth hotspot for 5 minutes for the user to connect.

## 6. Error Indicator

This indicator is normally off if no fault is present inside the SHP. It will turn red if there is a fault in the product. Users can go to the app for a fault diagnostic report. If there is an issue, please contact customer support for assistance.

## 7. Power Station Pause/Resume Button

The pause button will physically isolate the 10 load circuits and lock out both connected DELTA Pros. A signal from the SHP will tell the DELTA Pros to stop outputting power. Please note that this does not substitute for a service disconnect, nor does it substitute for the de-energization procedure required before servicing.

### NOTE

This is the only "quick disconnect" that can be used to manually cut all power in an emergency. AC in and Pro in still energize.

## 3.2 Internal Features

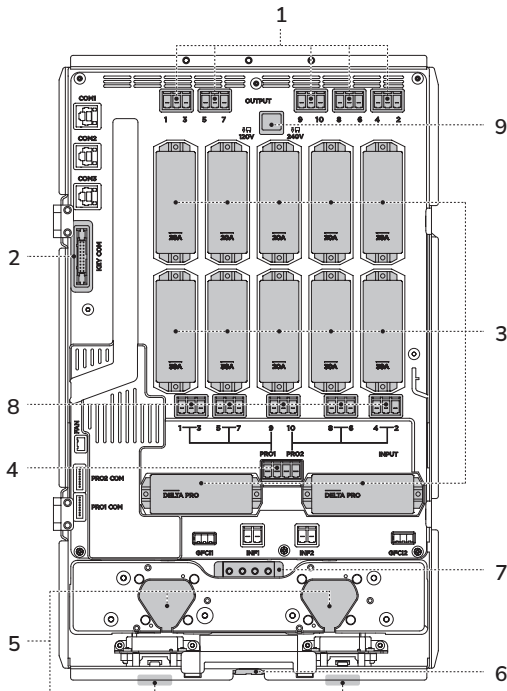

## 1. Output Wire Connectors

These are the wire connectors for output hot wires going to the load.

## 2. Communication Ports connecting to the key panel

## 3. Relay Modules

The relay modules are available in different current ratings, 6A, 13A, 16A, 20A, and 30A. These modules contain two relays for each circuit as well as an overcurrent protection fuse. Each module can be individually replaced without affecting other circuits. De-energize the SHP before replacing any module.

## 4. DELTA Pro Wire Connectors

These are wire connectors for DELTA Pro. There is one hot wire and one neutral wire required for each DELTA Pro. At least one neutral wire must be connected to the main panel even if no DELTA Pro is used. This neutral is used as a return path for DELTA Pro to power your circuits.

## 5. Infinity Ports

Infinity ports can be installed either on the front or the bottom of the product. Users can choose to switch the position of the Infinity ports. This can improve cable management in tight quarters.

## 6. Cooling Fan

The cooling fan is activated under extreme operating conditions to reduce the ambient temperature inside of the unit.

## 7. Ground Bus Bar

This is the ground bus bar, which should be connected to the ground bus bar in the main electrical panel. The panel casing is connected to this ground. NOTE: Please follow local code requirements with regard to bonding neutral and ground. Bonding should be done at the first means of disconnect, which is the service panel, NOT the SHP.

## 8. Input Wire Connectors

These are the wire connectors for hot wires coming from the circuit breakers in your main panel.

## 9. Switching Connector

Please keep the connector plugged in its original place, otherwise, if it's unplugged, the power station connected to Pro 1 will only provide energy to circuits 1, 3, 5, 7, and 9, whereas the power station connected to Pro 2 will only provide energy to circuits 2, 4, 6, 8, 10.

## 4. What's in the Box

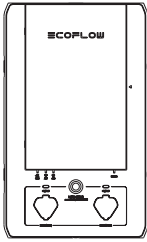

Smart Home Panel

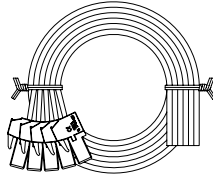

Infinity Cable and Wires



A bag of accessories

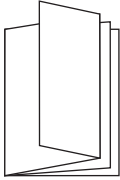

Product User Manual

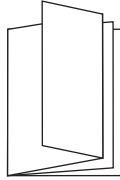

Product Installation  
Manual

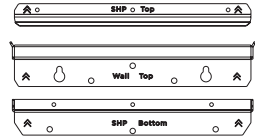

Wall mounting brackets



Relay module

### NOTE

The AWM wires can be removed from the harness plugs and replaced with an appropriate length and type of cable.



## 5. Installation SOP Checklist

| No.   | Checklist   | Status |
|---|---|--------|
| <b>Before installation- Project information</b>               |   |        |
| 1   | Determine the installation location. The Smart Home Panel is rated to IP20, therefore, it needs to be installed away from direct sunlight, rain, snow and moisture.   |        |
| 2   | Determine the distance between the SHP and main electrical panel.   |        |
| 3   | Confirm the number of loads to be connected to SHP. You can connect up to 10 single pole load circuits.   |        |
| 4   | Determine whether the upstream circuit breakers of the selected loads require AFCI or GFCI protection. This can be accomplished with an on-site inspection or photo or video of the panel from the end user.  |        |
| 5   | Determine and gather required materials. SHP can support up to 1 1/4 inch conduit via five knockouts. Ensure that necessary adjustment factors (for number of conductors) are accounted for and that wire ampacity is sized appropriately. For longer runs it is recommended that you use separate conduits for the input and output wires. For AFCI and GFCI breakers, an additional standard overcurrent trip breaker is required. For circuits where AFCI protection is required, metal conduit or whip to the SHP from the main panel is required. An external AFCI enclosure (available from EcoFlow) to house AFCI breakers is also required downstream of the SHP. |        |
| <b>During installation - Circuit breaker and relay module</b> |   |        |
| 1   | The current rating of relay module must match the upstream circuit breaker. Failure to do so may cause overcurrent protection to fail.  |        |
| 2   | The ampacity rating of wiring used should match the circuit current. Using an undersized cable may cause overheating and even a fire.   |        |
| 3   | All upstream breakers should be non-GFCI/AFCI. Any AFCI/GFCI breakers need to be moved downstream of the SHP using an optional accessory box.   |        |
| <b>During installation - Wiring</b>                           |   |        |
| 1   | Each load circuit AC input should be connected to the hot wire.   |        |
| 2   | Install the relay modules in the corresponding places and secure by tightening the screws. Failure to do so may cause the relay module to come loose, which will produce an error and disconnection of the load channel, as well as risk overheating and fire.  |        |

## During installation - Check wiring

|   |  |  |
|---|--|--|
| 1 | With a multimeter in continuity setting, confirm that the hot wire in of each SHP channel is not shorted to neutral. |  |
| 2 | With a multimeter in continuity setting, confirm that the hot wire in of each SHP channel is not shorted to ground.  |  |

## Commissioning

|    |  |  |
|----|--|--|
| 1  | Make sure the power stations are enabled and that the stop button is off (raised).   |  |
| 2  | Close the upstream breaker of DELTA Pro and energize the DELTA Pro AC Input channel. The grid indicator (white) will turn on if there is no fault.   |  |
| 3  | Turn each branch circuit breaker back on one by one and check the indicator status of each channel and power indicator. The indicators will stay white.  |  |
| 4  | If you haven't done so already, download the EcoFlow App from Google Play or the App Store and create an EcoFlow account. Open the app on your mobile device, log into the app and add the Smart Home Panel to your device pool. For first time users, the app will lead through a commissioning process to setup the SHP. |  |
| 5  | Update the firmware of the Smart Home Panel to the latest version, then check whether there are any errors reported on the app.  |  |
| 6  | Follow the instructions in the app to conduct device wiring testing. If the device wiring testing fails, correct the wiring following the prompts in the app and re-run the wiring test.   |  |
| 7  | Turn on the DELTA Pro and update the firmware to the latest version.   |  |
| 8  | Connect the DELTA Pro and Smart Home Panel using the Infinity cable. For split-phase, two DELTA Pros and two infinity cables are required. Turn on the main power button of DELTA Pro, then press the On/Off button (AC button, near the infinity port) on the SHP to enable each DELTA Pro.                               |  |
| 9  | Switch the power supply from grid to power station for each channel via the app. Check whether the switchover is successful and there are no errors reported on the app. Follow the instructions on the app to fix the errors if any.  |  |
| 10 | Set up the charging for DELTA Pro on the app (if AC grid charging is desired), check whether the DELTA Pro is recharged successfully and there are no errors reported on the app. Follow the instructions on the app to fix the errors if any.   |  |

# 6. Installation Steps

## 6.1 Preparation

### Tools and Items Needed for Installation:

Tools required:

1. Level
2. Phillips head screwdriver, Torx T20 screwdriver and 7mm socket screwdriver
3. Pliers
4. Wire cutters
5. Wire nuts
6. Drill
7. Conduit (e.g. 1,1/4 inch and 1 inch), Conduit whip
8. Wire harness
9. Tape measure
10. Multimeter
11. Voltage detector
12. Purchase a new double pole 30A circuit breaker or two single pole 30A circuit breakers. (NOTE: these breakers may be required to be handle tied per code.)

### WARNING

Installation of this product involves high voltage. Please hire a licensed electrician to perform the installation.

### Load Calculation Example

The total DELTA Pro wattage (3600W for single Pro or 7200W for two Pros) should be greater than the total continuous running wattage of all backed up loads plus the largest start-up wattage.

| Circuit | Name           | Wattage       | Circuit | Name              | Wattage |
|---------|----------------|---------------|---------|-------------------|---------|
| 1       | Refrigerator   | 700W running  | 2       | Bedroom Light     | 500W    |
|         |                | 2000W startup |         |                   | 0W      |
| 3       | Kitchen Light  | 200W          | 4       | Living Room Light | 400W    |
|         |                | 0W            |         |                   | 0W      |
| 5       | Kitchen Plug   | 1400W         | 6       | Bathroom Light    | 300W    |
|         |                | 1000W         |         |                   | 0W      |
| 7       | Bedroom Plug   | 800W          | 8       | Living Room Light | 1200W   |
|         |                | 0W            |         |                   | 0W      |
| 9       | Sump Pump Plug | 700W          | 10      | Furnace           | 700W    |
|         |                | 1000W         |         |                   | 1000W   |

|   |                         |
|---|-------------------------|
| Total Running Load                                  | 6900 W                  |
| Largest Estimated Simultaneous Running Load (LESRL) | 2300 W                  |
| Largest Startup Wattage (LSW)                       | 2000 W                  |
| Minimum Backup Power Needed = LESRL + LSW           | 4300 W (Two DELTA Pros) |

**NOTE**

Inductive loads such as air conditioners, clothes dryers or pumps have high Inrush current when starting. This may trip the relay modules because of overload. Ensure the circuit is sized appropriately for the intended load.

Once you have determined the load circuits that you want to back up, fill out the table below. The numbering arrangement is the same as your SHP.

| Circuit | Original Phase | Name | Circuit | Original Phase | Name |
|---------|----------------|------|---------|----------------|------|
| 1       | 1              |      | 2       | 1              |      |
|         | 2              |      |         | 2              |      |
| 3       | 1              |      | 4       | 1              |      |
|         | 2              |      |         | 2              |      |
| 5       | 1              |      | 6       | 1              |      |
|         | 2              |      |         | 2              |      |
| 7       | 1              |      | 8       | 1              |      |
|         | 2              |      |         | 2              |      |
| 9       | 1              |      | 10      | 1              |      |
|         | 2              |      |         | 2              |      |

## 6.2 Installation

De-energize the system: When you are ready to start the installation work, turn off the main breaker as well as each branch circuit breaker intended to be connected. Ensure that DELTA Pros are not connected to the SHP as well.

### 6.2.1 Installing the Relay Module

The relay modules are shipped separately from the main unit. These modules include two switching relays and a fuse. The fuse is for load circuit protection in the backup mode only and therefore should match the current rating for the circuit breaker upstream of that load circuit. There are three standard ratings for the modules, 6A, 13A, 16A, 20A, 30A. Users should install these modules at the position corresponding to the load circuits that they plan to use it for according to the diagram below. The diagram below shows the module position corresponding to the circuit number.

There are 10 module mounting spaces inside the SHP as shown below. 4 out of the 10 channels (channel 1-4) have a maximum of 30A current rating, the rest have a maximum 20A current rating. No load circuit larger than the maximum current rating for a channel should be connected. Once placed into position, two screws are used to secure the module into place.

It's easier if the knockouts are removed before the SHP is installed on the wall.

#### **NOTE**

The actual continuous current rating for each relay module is 80% of module rating. For example, for the 20A relay module, the continuous current rating is  $20A \times 0.8 = 16A$ .

## Relay Module Position

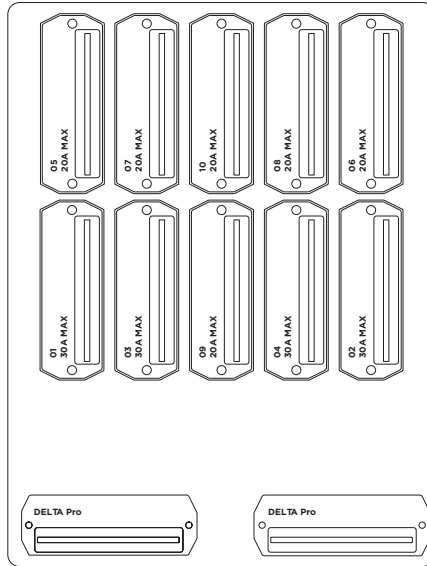

## Install Relay Module

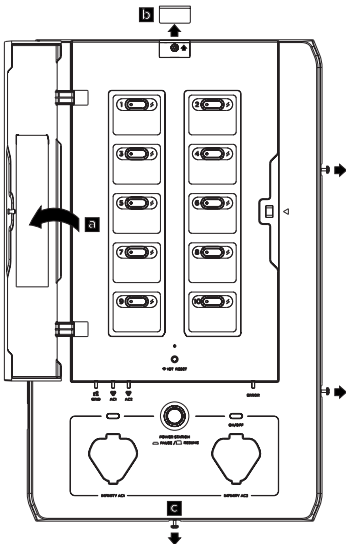

1. (a) Open the panel cover using the T20 screwdriver.  
(b) Slide out the screw cover on top.  
(c) Release the four screws one by one.

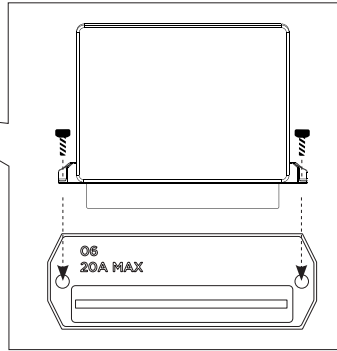
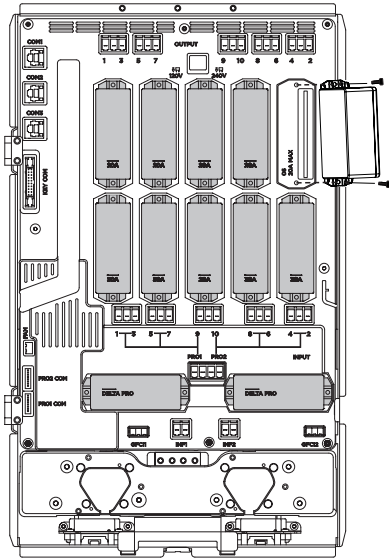

2. (a) Plug in each relay module and seat firmly (it is recommended to use the palm of your hand).
- (b) Secure the relay module by tightening the two screws.
- (c) Close the front panel, and secure the four screws.
- (d) The Relay Module installation is complete.
- (e) Repeat for all 10 relays. 10 relays must be installed even if they are not all used

## 6.2.2 Mounting

After you have placed the relay module inside and fastened the screws, attach both top and bottom mounting brackets to the SHP as shown below.

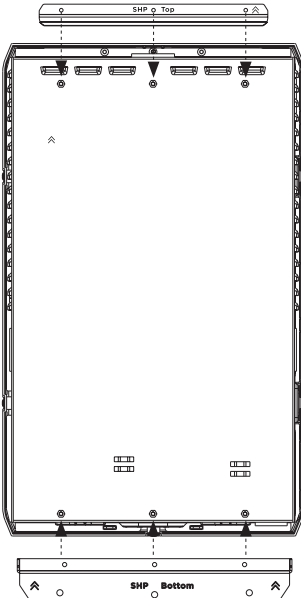

**1**

Position the SHP center to center to your main panel. Please follow the local safe electrical clearance distance.

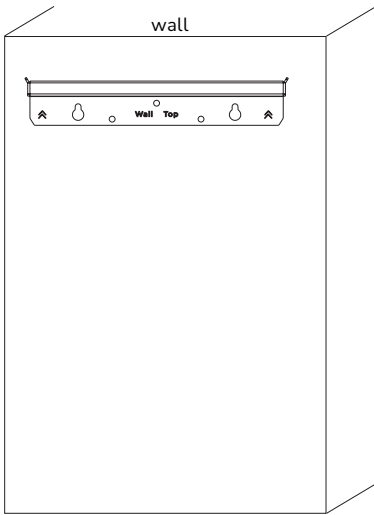

2

Attach the top mounting bracket along the top edge of the mark on the wall. Make sure you also check the length of the flexible conduit.

3

Hang the SHP up on the wall bracket.  
Secure the bottom mounting bracket to the wall.

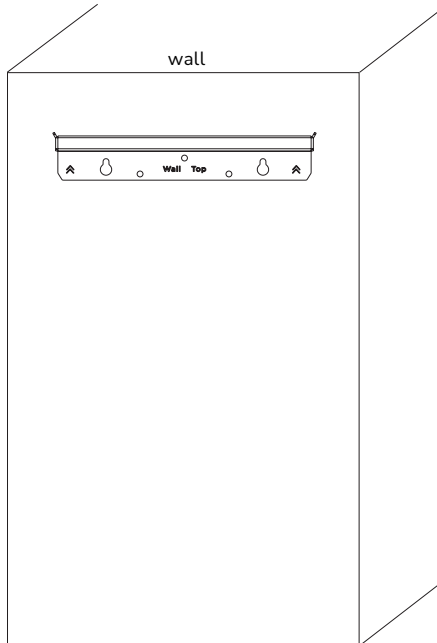
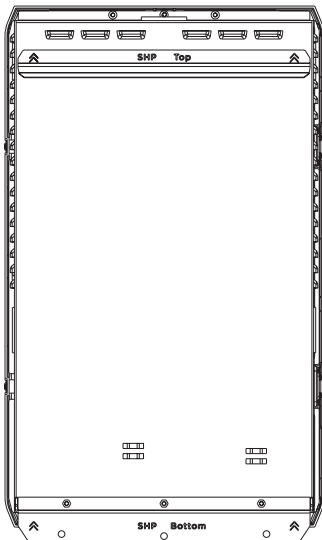



## 6.2.3 Wiring

### Wiring inside the Smart Home Panel

All wires come labeled in the box, 12 input wires, labeled "1 in - 10 in" "Pro1 in, Pro2 in" connected to the circuit breakers, 10 output wires, labeled "1 out - 10 out" connecting to the load hot wires, two neutral wires connecting to the neutral bus bar in the main panel and ground wire connecting to the ground bus bar in the main panel. Users should connect all input, output, neutral and grounds wire to their designated connectors inside the SHP.

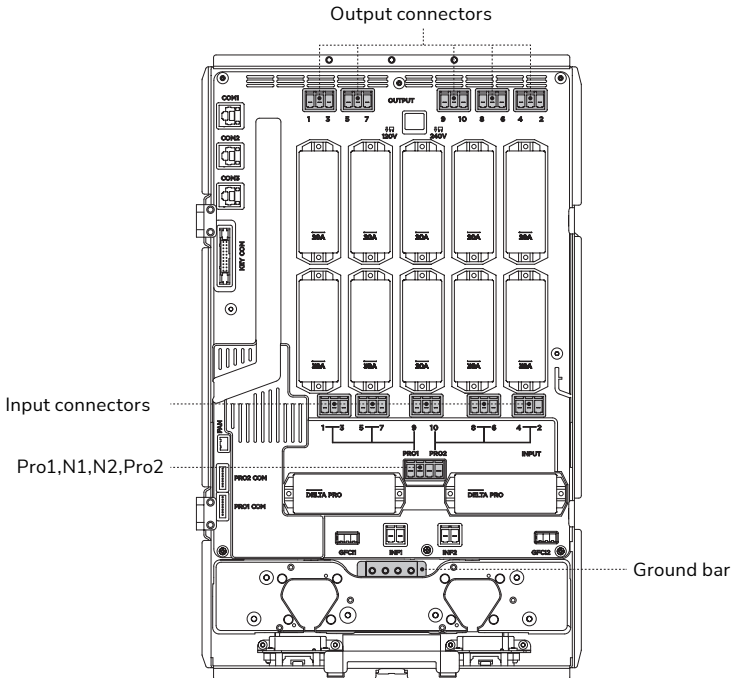

### NOTE

Two neutral wires and the ground wire must be connected to the main panel in order for the SHP to operate correctly and safely.

The maximum current for circuits 1-4 is 30A. Maximum current for circuits 5-10 is 20A. The current rating for each circuit should not be exceeded. Please plan the load circuits appropriately. If a non-metallic conduit is used to connect between the main panel and SHP, an equipment grounding conductor needs to be present inside each conduit. Additional ground wires can be connected between the ground bar inside the main panel and the SHP.

You may use your own wires with the connectors instead of the included wire. Use a screwdriver to remove the connectors, strip the wire and then insert and torque down

## Wiring in the Electrical Panel

1. Turn off the main breaker as well as the 10 branch circuit breakers intended to be connected in the main panel and use a voltage detector or voltmeter to make sure the system is fully de-energized.
2. Remove the front cover of the main panel. Keep in mind that the grid side of the main panel (upstream of the main breaker) is still energized.
3. Remove the knockouts that you want to use on both the SHP and the main electrical panel.
4. Attach both top and bottom conduit to the SHP and main electrical panel.
5. Pull all wires (Input, output, neutral and ground) from the SHP to the main electrical panel.
6. Connect the two neutral wires and the ground wire to the neutral and ground bus respectively. Cut them to the appropriate length before connecting.
7. Remove the hot wire from the circuit breaker. Connect each load hot wire to the corresponding output wire from the SHP using wire nuts (for example, the output wire labeled "1 out" means it's the output for channel 1). Make sure it's connected to the right number as planned.
8. Connect the input wire, with the same number (for example, if you used "1 out", now you should find the red wire labeled "1 in"), to the circuit breaker planned. Make sure you cut them to the appropriate length before connecting.
9. Repeat step 7 & 8 for all 10 load circuits.
10. Each charging circuit for DELTA Pro needs to feed off a single 30A breaker from the main panel to enable the fast charge function. If not available, 30A circuit breakers need to be purchased and installed. The wires corresponding to the PRO charging wires are labeled "PRO1 in" and "PRO2 in". If the 30A breaker is not used, the correct current rating should be entered into the app later on to prevent the circuit breaker tripping from charging current. It is recommended to handle tie both charging breakers or use a double pole breaker. This makes de-energization of the SHP safer for future servicing.

## Installation steps

1. Run a cable from the grounding bus of the main electrical panel to the grounding bar in SHP. Install two 30A single pole or one 30A double pole circuit breaker(s) to the main electrical panel and connect Pro 1 and Pro 2 modules in SHP with a 10AWG cable to provide AC charging and overcurrent protection for the Delta Pro(s).

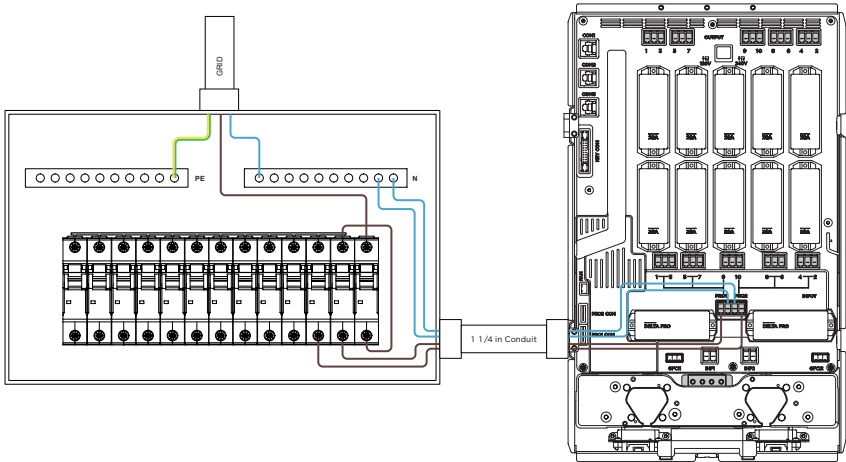
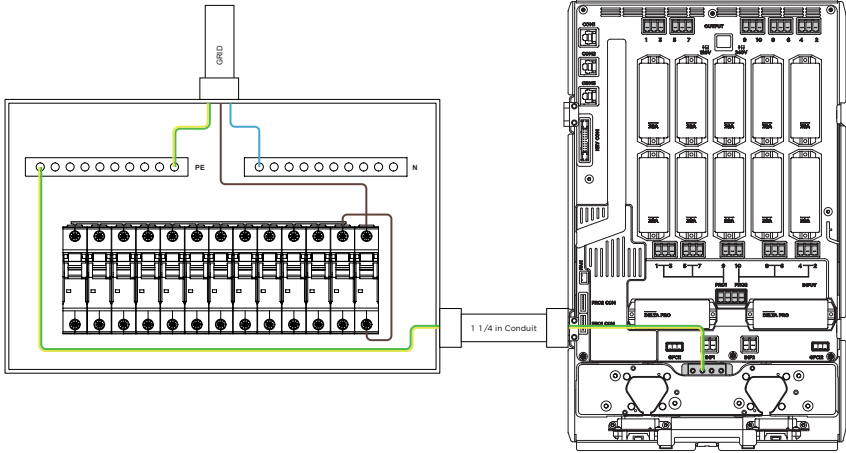

2. Connect input wires from SHP to corresponding breakers of the main electrical panel and output wires to the load port of the main electrical panel.

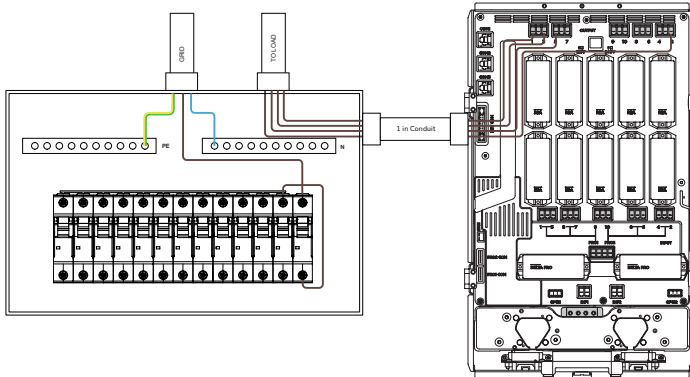
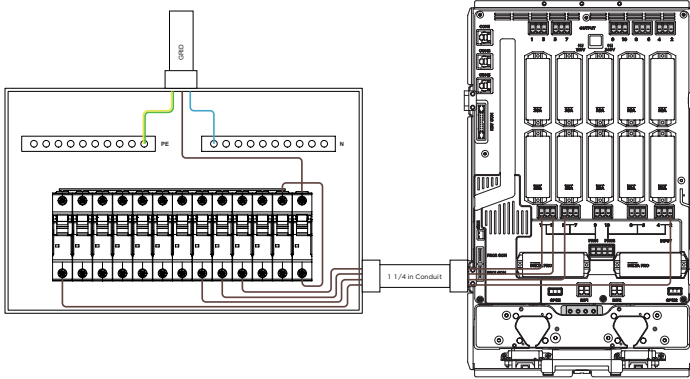

Bind the wires together with a wire tie at the outlet of SHP to fasten all the wires.

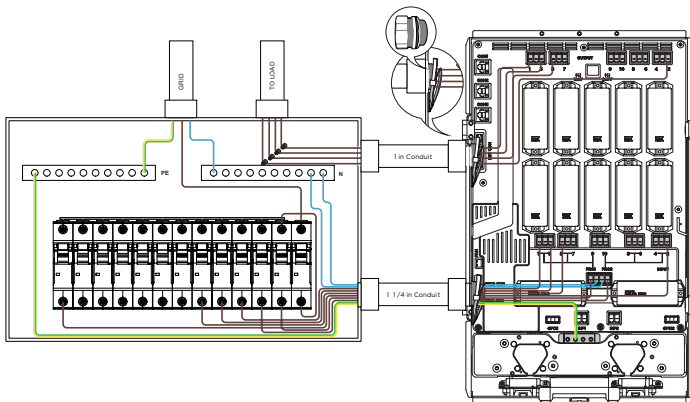

## 7. System Commissioning and App Setup

After you have connected all wires accordingly, clean up all the wires and tie them using a wire harness. Close the front panel and tighten the screws to secure the door. Label the circuit names accordingly on the SHP.

1. Download the EcoFlow app from the App Store, Google Play Store or EcoFlow official site. Set up the account and sign in.
2. Connect a DELTA Pro to the SHP without pressing the enable button.
3. Press the IOT button to enable Bluetooth connection. When the indicator light is flashing, it's ready to pair with the EcoFlow App.
4. Open the EcoFlow App and add the device from the "+" icon on the top right. Find the SHP and click the icon to pair. After Bluetooth connection, you will be asked to choose the Wi-Fi and enter Wi-Fi password to finish Internet connection.
5. For first time users, the app will lead through a commissioning process to setup the SHP. Simply follow the steps to complete the process. Once you have finished the commissioning process on the app, you are ready to energize the SHP.
6. After completing the device wiring test, press the enable button (near the infinity port) for the connected DELTA Pro. The power indicator should turn green. Watch for any abnormal signs and fault indication.
7. If there is no sign of fault, turn the main breaker back on and then turn each branch circuit breaker back on one by one and watch for any fault indication.
  - a. If the device wiring testing reports any errors, or if there are any errors, please resolve the issue following the message shown on the App or contact our customer support from the Help Center in the App. You can leave your SHP as long as there is no indication of electrical or other type of sign for a fault. The default mode for SHP is grid power so it will not affect your use of power.
  - b. If there is no sign of error, congratulations! You are ready to go!

### WARNING

The SHP defaults to grid mode when without power, which means the load is automatically connected to the grid power if no power is supplied to the SHP or it's started for the first time. Please make sure energization of load circuits do not endanger any person or incur any property damage before closing the main breaker.

## APP

Control and monitor EcoFlow portable power stations and the SHP remotely with the EcoFlow App. Download at: <https://download.ecoflow.com/app>



## Privacy Policy

By using EcoFlow Products, Applications, and Services, you consent to the EcoFlow Terms of Use and Privacy Policy, which you can access via the "About" section of the "User" page on the EcoFlow App or the official EcoFlow website at <https://ecoflow.com/pages/terms-of-use> and <https://ecoflow.com/pages/privacy-policy>.

## 8. FAQ

**1. Can the SHP connect to a roof solar system, if yes, how?**

For DC coupled solar panel system, currently, only solar panels with the correct output parameters can be connected to the system. See the DELTA Pro manual for supported solar panel specifications.

**2. What's the maximum number of DELTA Pros and extra batteries that can be connected to the SHP?**

A maximum of 2 DELTA Pros and 4 extra batteries can be connected, with a total of 7200W output power and 21.6kWh of energy.

**3. Can multiple smart panels be used at the same time in one house?**

Yes.

**4. Can I manually switch between grid power and backup power?**

Yes. Through the EcoFlow App.

**5. How many circuits can SHP manage?**

A maximum of 10 single phase circuits.

**6. Is there any protection function in the SHP?**

Yes. There is a relay based overcurrent and over-temperature protection system in both the grid and backup mode. There is also a fuse for fault protection in the backup mode only.

**7. Is there an AFCI function provided by the SHP?**

No, an additional accessory needs to be purchased to house an AFCI breaker

≡COFLOW