



RECORD THIS INFORMATION FOR FUTURE REFERENCE:

Model Number \_\_\_\_\_  
Serial Number \_\_\_\_\_  
Date Purchased \_\_\_\_\_  
Retailer / Qualified Installer \_\_\_\_\_

**OPERATING  
INSTRUCTIONS**

**TYPE**

**9500E**

(120 VAC) POWER  
CASE / CASSETTE AWNING

**MODEL**

**202(LL)(CC).003(#)**



Read these instructions carefully. These instructions **MUST** stay with this product.

**REVISION B**  
Form No. 3314490.000 09/16  
(French 3314491.000\_B)  
©2016 Dometic Corporation  
LaGrange, IN 46761

**USA**  
SERVICE OFFICE  
Dometic Corporation  
1120 North Main Street  
Elkhart, IN 46514

**CANADA**  
Dometic Corporation  
46 Zatonski, Unit 3  
Brantford, ON N3T 5L8  
CANADA

**SERVICE CENTER &  
DEALER LOCATIONS**  
Please Visit:  
[www.eDometic.com](http://www.eDometic.com)

# INTRODUCTION

This cassette awning (hereinafter referred to as “awning,” or “product”) is designed and intended for use on RVs with straight sides. It is especially well suited for RVs with an over cab extension where there is not sufficient surface for a bottom mounting bracket. Use these instructions to ensure correct operation of product.

Dometic Corporation reserves the right to modify appearances and specifications without notice.

# TABLE OF CONTENTS

INTRODUCTION.....	2
DOCUMENT SYMBOLS .....	2
IMPORTANT SAFETY INSTRUCTIONS.....	3
A. Recognize Safety Information .....	3
B. Understand Signal Words.....	3
C. Supplemental Directives.....	3
D. General Safety Messages .....	3
OPERATION.....	4
A. Open Awning .....	4
B. Water Shed Feature .....	4
C. Close Awning.....	5
D. Prepare Awning For Travel .....	5
SETTINGS AND ADJUSTMENTS.....	6
A. Reset Wind Sensor.....	6
B. Predefined Wind Sensor Adjustment.....	7
C. Personalized Wind Sensor Adjustment .....	8
D. Set / Reset Awning Intermediate Position .....	8
E. Reset Awning Out Limit .....	9
F. Reset Motor And Remote .....	9
BATTERY REPLACEMENT .....	10
A. Remote.....	10
B. Wind Sensor.....	10
CLOSE AWNING MANUALLY (POWER FAILURE).....	11
GENERAL CARE AND USE.....	12
A. Precautions.....	12
B. Hardware Maintenance .....	12
C. Fabric Maintenance .....	12
D. When To Get More Help.....	12
APPENDIX A: TROUBLESHOOTING .....	13

# DOCUMENT SYMBOLS

 Indicates additional information that is **NOT** related to physical injury.

 Indicates step-by-step instructions.

# IMPORTANT SAFETY INSTRUCTIONS

This manual has safety information and instructions to help you eliminate or reduce the risk of accidents and injuries.

## A. Recognize Safety Information



This is the safety alert symbol. It is used to alert you to potential physical injury hazards. Obey all safety messages that follow this symbol to avoid possible injury or death.

## B. Understand Signal Words

A signal word will identify safety messages and property damage messages, and will indicate the degree or level of hazard seriousness.

**WARNING** indicates a hazardous situation that, if **NOT** avoided, could result in death or serious injury.

**CAUTION** indicates a hazardous situation that, if **NOT** avoided, could result in minor or moderate injury.

**NOTICE** is used to address practices **NOT** related to physical injury.

## C. Supplemental Directives



Read and follow all safety information and instructions to avoid possible injury or death.

Read and understand these instructions before [installing / using / servicing / performing maintenance on] this product.

Incorrect [installation / operation / servicing / maintaining] of this product can lead to serious injury. Follow all instructions.

The installation **MUST** comply with all applicable local and national codes, including the latest edition of the following standards:

### U.S.A.

- ANSI/NFPA70, National Electrical Code (NEC)
- ANSI/NFPA 1192, Recreational Vehicles Code

### CANADA

- CSA C22.1, Parts I & II, Canadian Electrical Code
- CSA Z240 RV Series, Recreational Vehicles

## D. General Safety Messages

**WARNING** Failure to obey the following warnings could result in death or serious injury:

- This product **MUST** be [installed / serviced] by a qualified service technician.

- Do **NOT** modify this product in any way. Modification can be extremely hazardous.

- Frequently examine product for imbalance (uneven fit / sagging / loose parts); and signs of wear or damage to wiring (if applicable) and other critical parts. Do **NOT** use product if adjustments or repairs are necessary.



Critical parts may include awning fabric, cables, arm assemblies, etc.

- Disconnect product from power supply (if applicable), and do **NOT** operate product when maintenance (such as window cleaning) is being carried out in the vicinity.

- Do **NOT** allow anyone (including children) with reduced physical, sensory or mental capabilities, or lack of experience and knowledge to use this product, unless they have been given supervision or instruction (concerning use of this product) by a person responsible for their safety.

- Do **NOT** allow children to play with product or with fixed controls (if applicable).

- Keep remote controls (if applicable) away from children.

- Do **NOT** add any devices or accessories to this product except those specifically authorized in writing by Dometic Corporation.

- **IMPACT OR CRUSH HAZARD. NEVER** leave an open awning unattended. Keep awning stowed (closed) when snow, heavy rain, wind, and severe weather conditions are expected.

- **IMPACT OR CRUSH HAZARD. Do NOT** allow water to pool, snow to accumulate, or heavy debris on awning fabric. Do **NOT** hang or place anything on awning. The awning will become unstable, and could bend or collapse.

- **FIRE HAZARD.** Keep sources of heat and fire (barbecue grills, portable heater, etc.) away from awning.

**CAUTION** Failure to obey the following cautions could result in injury:

- **PINCH HAZARD.** Maintain a horizontal distance of at least 16" between fully open awning and any permanent object.



Do **NOT** face awning toward permanent objects that may interfere with awning operation.

- **PINCH HAZARD.** Keep **CLEAR** of arm assemblies while awning is open. If awning is equipped with a wind sensor, arm assemblies will automatically [fold / close] against back rail during windy conditions.

# OPERATION

## A. Open Awning

**⚠ CAUTION** PINCH HAZARD. Maintain a horizontal distance of at least 16" between fully open awning and any permanent object. Failure to obey this caution could result in injury.

**NOTICE** Do **NOT** allow awning fabric to rest on rafters. Wind will cause awning fabric to rub against arm assemblies which could result in premature wear and abrasions.

Press the open (down arrow) button briefly on awning remote. Awning will extend to its out limit. See (FIG. 1), (FIG. 2), & (FIG. 3).

**i** When awning is fully extended, the fabric edges **MUST** be taut. If awning fabric edges are sagging, the out limit will need to be reset. See "E. Reset Awning Out Limit" on page (9).

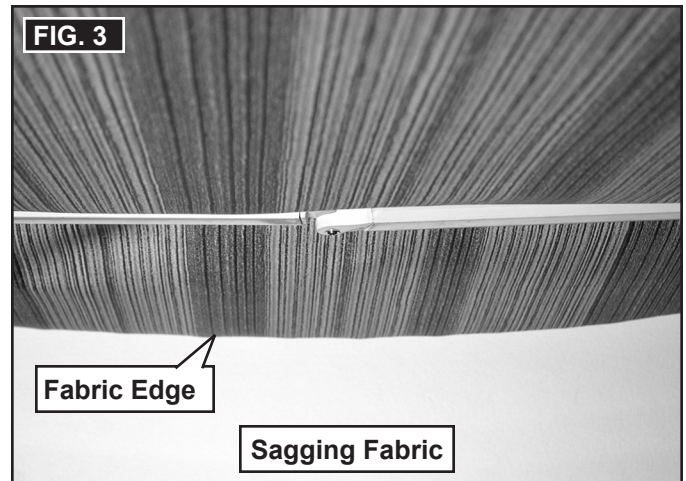
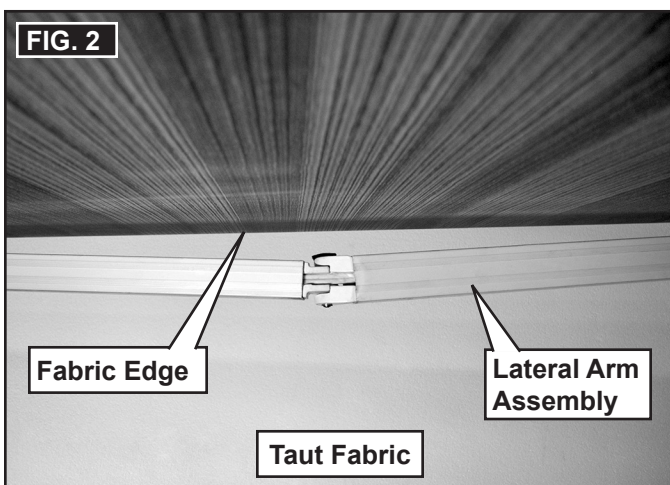
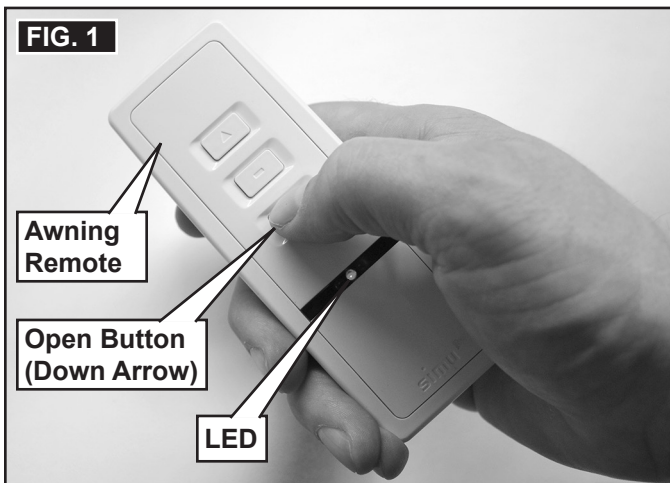

## B. Water Shed Feature

**⚠ WARNING** Failure to obey the following warnings could result in death or serious injury:

- **IMPACT OR CRUSH HAZARD.** Do **NOT** allow water to pool or snow to accumulate on awning fabric. The awning will become unstable, and could bend or collapse. Whenever heavy rain or snow is expected, place awning in stowed (closed) position.
- **IMPACT OR CRUSH HAZARD.** Do **NOT** constrain or tie down lead rail as this could disable the water shed feature.

This awning is designed with a water shed feature that automatically lowers one side of awning during light rain to allow water run off.

**i** This water shed feature is meant for light rain only.

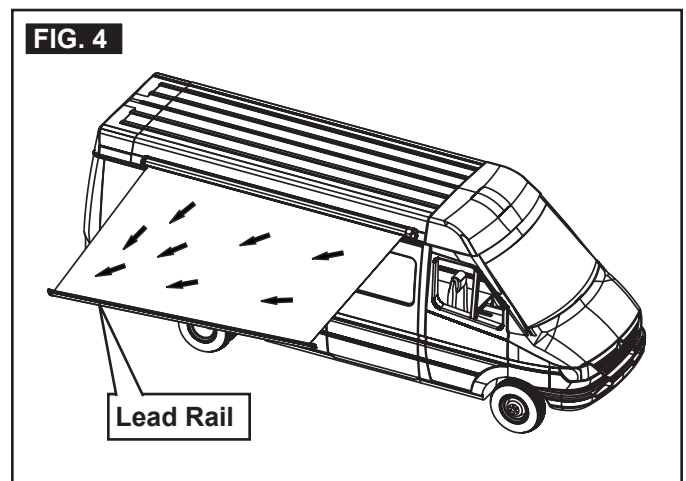

# OPERATION

## C. Close Awning

**⚠ WARNING** PINCH HAZARD. Keep **CLEAR** of arm assemblies while closing awning. Arm assemblies will [fold / close] against back rail. Failure to obey this warning could result in death or serious injury.

Press the close button (up arrow) briefly on awning remote. Awning will retract until it's closed. See (FIG. 5).

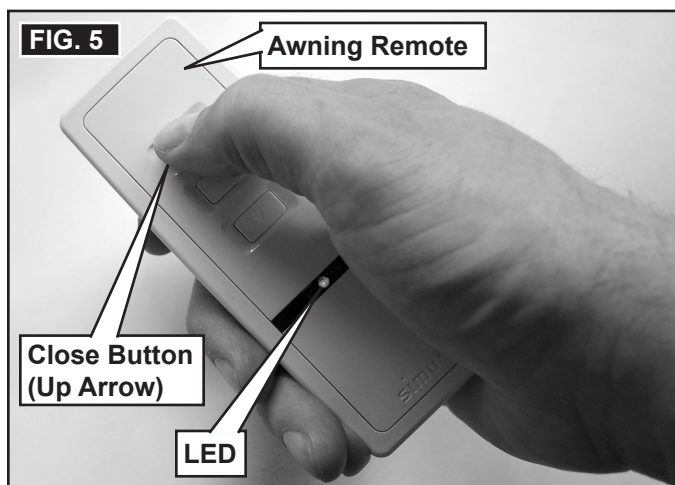

## D. Prepare Awning For Travel

**⚠ WARNING** IMPACT OR CRUSH HAZARD. Do **NOT** transport RV if awning fabric is torn / damaged, even if awning closes successfully. Damaged awning fabric could compromise awning's stability, and could allow awning to extend quickly and unexpectedly during transit. Failure to obey this warning could result in death or serious injury.

Inspect Awning for damage.

**i** If awning fabric is torn / damaged, tie all lateral arm assemblies securely (with fabric strapping or light rope) near shoulder and wrist to close awning as much as possible. Then contact a qualified Dometic service technician for on-site repair. See (FIG. 6).

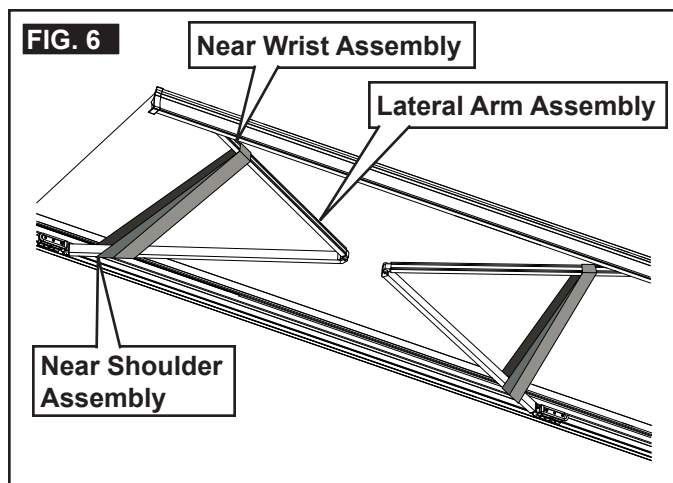

2. **⚠ WARNING** IMPACT OR CRUSH HAZARD. Verify ignition interlock is working correctly before traveling with RV. If awning responds to remote with ignition in **ON** position, accidental operation during transit could occur. The awning **MUST** be disabled, then serviced by a qualified service technician. Failure to obey this warning could result in death or serious injury.

With awning fully closed, Test ignition interlock system:

- With vehicle ignition in **ON** position, attempt to open awning.
  - If awning does **NOT** respond (remains closed), the ignition interlock is functioning. Skip to step (4).
  - If awning responds (awning opens), there is a problem with the ignition interlock system. Proceed to step (3).
3. Disable awning for travel to service center:
- Close awning and remove fuse for power source to awning.
  - Retest ignition interlock. See step (2).
  - If awning does **NOT** respond (remains closed), the awning is now disabled. Skip to step (f).
  - If an inverter is installed and awning still operates, disconnect awning motor wiring from inverter.
  - Repeat step (2) to verify motor is disabled.
  - Have awning repaired by a qualified service technician.
4. Verify awning is secure for travel.
- i** Look for loose parts, and any sign of instability.
5. Store remote in a secure location.



# SETTINGS AND ADJUSTMENTS

## A. Reset Wind Sensor

If awning is equipped with a wind sensor (located on inside surface of lead rail), awning will automatically close when windy conditions are present.

If wind sensor is not responding to windy conditions, it may need to be reset.

1. Verify wind sensor functionality.
  - a. With awning extended to its out limit, shake lead rail up and down 3" - 4" for approximately 8 seconds (to simulate wind vibration). Awning will retract until it's closed. See (FIG. 7).

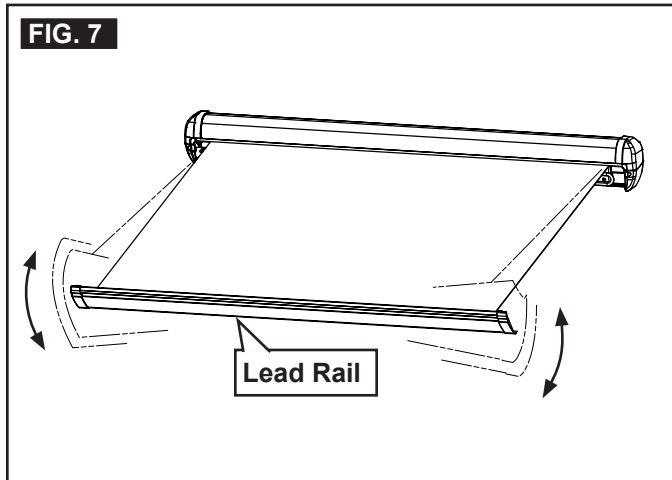

- b. If awning does not close, slide sensor cover (with wind sensor) to the left, and remove from sensor base. See (FIG. 8).

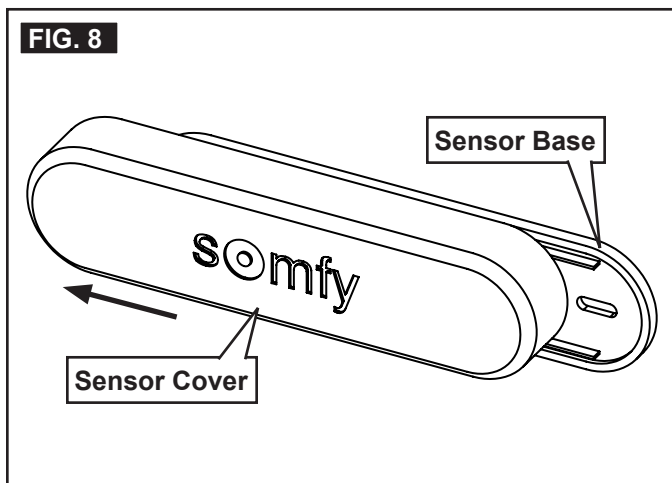

- c. With flat bladed screw driver, detach wind sensor from sensor cover. See (FIG. 9).

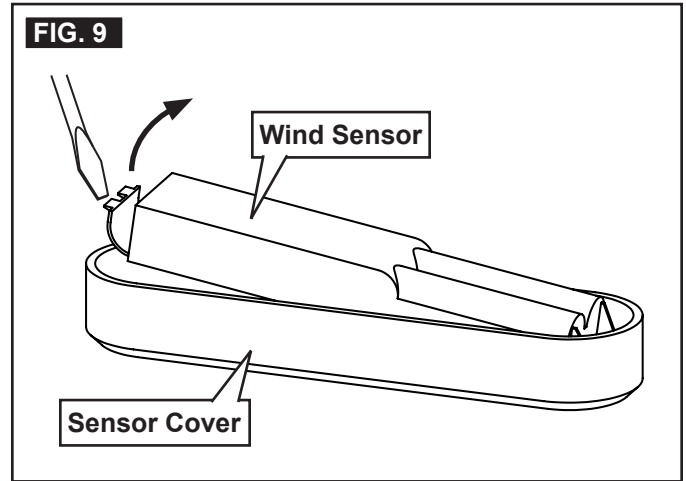

- d. Install new batteries (size AA) in wind sensor. See (FIG. 10).

 See "Battery Replacement" on page (10).

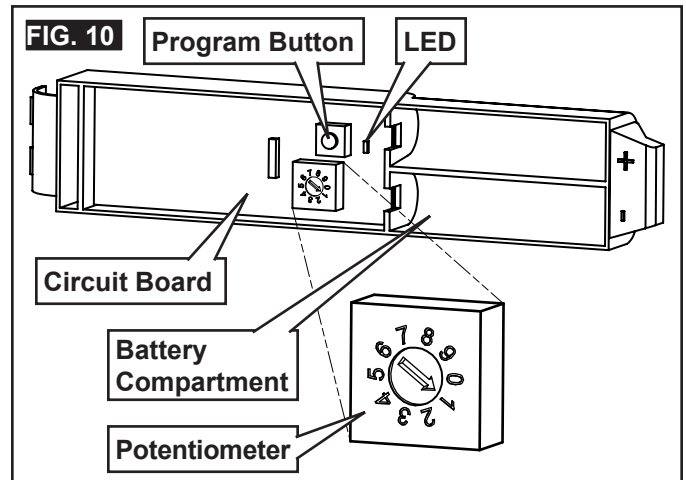

- e. Verify potentiometer sensitivity is set to desired predefined level (factory preset is "1"). Then reattach wind sensor to sensor cover, and install onto sensor base securely. See (FIG. 8), (FIG. 9), & (FIG. 10).
  - f. If awning still does not close when shaken, proceed to step (2).

# SETTINGS AND ADJUSTMENTS

2. Press program button on back of awning remote. Awning motor will jog momentarily. See (FIG. 11).

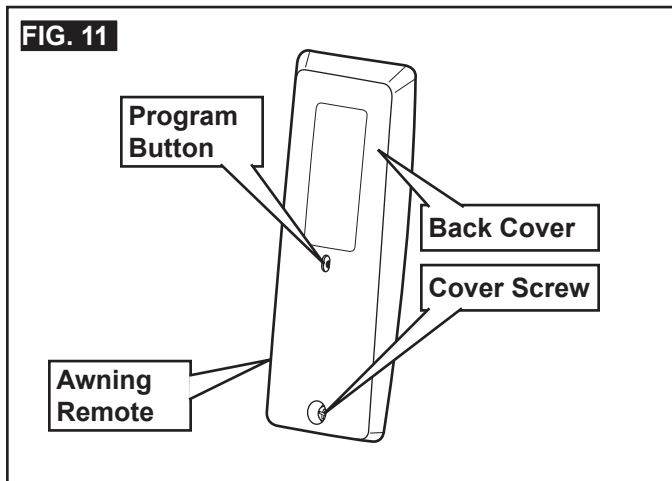

3. With wind sensor removed from sensor base, press program button on inside of wind sensor. Awning motor will jog momentarily. See (FIG. 10).

**i** The awning motor will only recognize wind sensor if the awning remote is fully programmed. See "F. Reset Motor And Remote" on page (9) if necessary.

4. Reattach wind sensor to sensor cover, and install onto sensor base securely. See (FIG. 8) & (FIG. 9).
5. Shake the lead rail up and down 3" - 4" for approximately 8 seconds (to simulate wind vibration). Awning will retract until it's closed. See (FIG. 7).

**i** Awning motor will **NOT** operate for approximately 30 seconds after awning is closed by wind sensor.

6. If awning does not close when shaken, repeat steps (2) through (5) before contacting a qualified Dometic service technician.

## B. Predefined Wind Sensor Adjustment

If wind sensor is not responding appropriately to windy conditions, or is closing awning during light breezes, it may need to be adjusted.

1. **⚠ WARNING** IMPACT OR CRUSH HAZARD. Make sure wind sensor sensitivity is set correctly to enable awning to close during windy conditions. Low sensitivity to high intensity wind will allow the awning to stay open during windy conditions, and could cause it to bend or collapse. Failure to obey this warning could result in death or serious injury.

Verify wind sensor functionality. See "A. Reset Wind Sensor" on page (6).

2. If wind sensor functions when shaken, but sensitivity needs adjustment, proceed with step (3).
3. Extend awning to its out limit.

4. **⚠ CAUTION** PINCH HAZARD. Do **NOT** remove wind sensor from sensor base until ready to complete procedure. Awning will close automatically 1 hour after wind sensor removal. Failure to obey this caution could result in injury.

Slide sensor cover from sensor base. Then detach sensor from sensor cover. See (FIG. 8) & (FIG. 9).

5. Using a small flat bladed screwdriver, set potentiometer sensitivity according to desired threshold. See (FIG. 10).
  - a. "1" is the highest predefined setting for wind sensitivity. Low intensity shaking will close the awning.
  - b. "9" is the lowest predefined setting for wind sensitivity. High intensity shaking is required to close the awning.

6. Once desired sensitivity is set, reattach wind sensor to sensor cover, and install onto sensor base securely. See (FIG. 8) & (FIG. 9).

7. With awning extended to its out limit, shake the lead rail for approximately 8 seconds (to simulate wind vibration) with the intensity desired to close awning. Awning will retract until it's closed. See (FIG. 7).

**i** Awning motor will **NOT** operate for approximately 30 seconds after awning is closed by wind sensor.

8. Repeat steps (3) through (7) if further adjustments are necessary.

**i** If predefined settings on potentiometer do **NOT** meet your desired wind sensitivity, a personalized setting may be necessary. See "C. Personalized Wind Sensor Adjustment" on page (8).

# SETTINGS AND ADJUSTMENTS

## C. Personalized Wind Sensor Adjustment

If wind sensor is not responding as desired to windy conditions (using the predefined settings), it may be adjusted to personalized preference.

-  1. **⚠ WARNING** IMPACT OR CRUSH HAZARD. Make sure wind sensor sensitivity is set correctly to enable awning to close during windy conditions. Low sensitivity to high intensity wind will allow the awning to stay open during windy conditions, and could cause it to bend or collapse. Failure to obey this warning could result in death or serious injury.

Verify wind sensor functionality. See "A. Reset Wind Sensor" on page (6).

2. If wind sensor functions when shaken, but sensitivity needs adjustment beyond what the predefined (potentiometer) settings can provide, proceed with step (3).

3. Extend awning to its out limit.

4. **⚠ CAUTION** PINCH HAZARD. Do **NOT** remove wind sensor from sensor base until ready to complete procedure. Awning will close automatically 1 hour after wind sensor removal. Failure to obey this caution could result in injury.

Slide sensor cover from sensor base. Then detach sensor from sensor cover. See (FIG. 8) & (FIG. 9).

5. Using a small flat bladed screwdriver, set potentiometer to "0". See (FIG. 10).

6. Reattach wind sensor to sensor cover, and install onto sensor base securely. See (FIG. 8) & (FIG. 9).

 Wind sensor is now in personalized detection mode.

7. With awning extended to its out limit, shake the lead rail for approximately 8 seconds (to simulate wind vibration) with the intensity desired to close awning. Awning will retract until it's closed. See (FIG. 7).

 Wind sensor recorded the intensity of vibration, and is now set to close when the wind intensity matches this personalized setting.

Awning motor will **NOT** operate for approximately 30 seconds after awning is closed by wind sensor.

8. Extend awning to its out limit.  
9. Repeat step (7) to test setting. If awning does not retract satisfactorily, proceed to step (10).  
10. Extend awning to its out limit (if applicable).  
11. Slide sensor cover (with wind sensor) from sensor base, and wait for 2 seconds. See (FIG. 8).

12. Install sensor back onto sensor base securely. See (FIG. 8).

 If sensor is removed from sensor base for more than 4 seconds, reinstall sensor onto sensor base and repeat steps (11) through (12).

13. Repeat step (7) through (9) to record and test new setting.

 If awning still does **NOT** retract satisfactorily, repeat steps (10) through (13) for further adjustments.

## D. Set / Reset Awning Intermediate Position

An intermediate limit may be programmed to open awning to a customized position (between the out limit and closed position).

-  1. Using awning remote, move lead rail to the desired position. See (FIG. 12).

a. Press the open or close button briefly on awning remote to move lead rail in desired direction.

b. When lead rail reaches desired position, press the stop button briefly to stop travel.

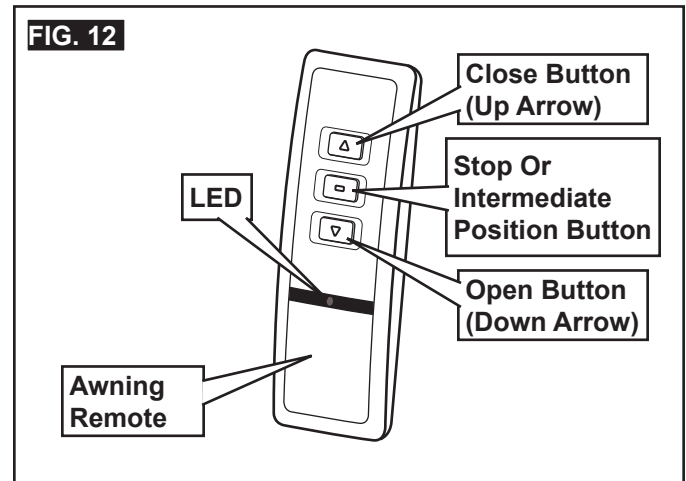

2. Press and hold stop button on awning remote for approximately 5 seconds. Awning motor will jog momentarily, indicating intermediate position is recognized. See (FIG. 12).

 If a different intermediate position is desired, repeat steps (1) through (2).

3. Press stop button briefly (from any position). Awning will extend to its intermediate position. See (FIG. 12).



# SETTINGS AND ADJUSTMENTS

## E. Reset Awning Out Limit

The awning limits are factory preset for optimal operation. However, if the awning does not fully extend, or awning over-extends causing the awning fabric to sag, the out limit may need to be reset. See (FIG. 3).

-  1. Press open (down arrow) button to extend awning to its current out limit. See (FIG. 12).

 If awning motor begins to back-wind (fabric wraps around roller tube backwards) after full extension, a full motor reset may be required. See "F. Reset Motor And Remote" on page (9).

2. Press and hold the close (up arrow) and open (down arrow) buttons simultaneously for approximately 6 seconds. Awning motor will jog momentarily. See (FIG. 12).
3. Press and hold the open (down arrow) or close (up arrow) button until lead rail is in desired out limit position, and awning fabric is taut. See (FIG. 2) & (FIG. 12).
4. Press and hold stop button for approximately 3 seconds. Awning motor will jog momentarily, indicating new limit is recognized. See (FIG. 12).

 If awning motor does **NOT** jog, a full motor reset may be required. See "F. Reset Motor And Remote" on page (9).

## F. Reset Motor And Remote

The awning motor and remote is factory preset for optimal operation. However, if the awning does not respond correctly to the remote (after first reviewing, "Appendix A: Troubleshooting" on page (13)), the motor and remote may need to be reset.

-  1. Verify awning motor and remote functionality.
- a. Press the open (down arrow) button briefly on awning remote. Awning will extend to its out limit. See (FIG. 12).

 If awning does **NOT** respond to remote, verify LED lights momentarily (on remote) when button is pressed. If LED does **NOT** light, install a new battery. See "Battery Replacement" on page (10).

If awning still does **NOT** respond, does **NOT** extend to its out limit, extends too far (fabric **NOT** taut), or stops when button is released proceed to step (2). See (FIG. 2) & (FIG. 3).

2. Turn power supply to awning motor off and on twice:

- a. Turn OFF and wait 10 seconds.  
b. Turn ON and wait 10 seconds.  
c. Turn OFF and wait 10 seconds.  
d. Turn ON and wait until awning extends or retracts momentarily, then stops.

3. Press and hold the program button on back of awning remote. See (FIG. 10).

While holding the program button, the awning motor will jog twice:

- a. Jogs momentarily.  
b. Wait 6 seconds, then jogs momentarily again.

4. If jog cycle is not successful, restart from step (2).

 If an earlier attempt to program the remote was aborted, the awning motor may **NOT** respond to remote's program button. If restarting from step (2) fails, try continuing procedure starting with step (6).

5. If jog cycle is successful, release program button and proceed to next step.

 All prior controls will be cleared from motor memory at this point.

6. Press and hold the close (up arrow) and open (down arrow) buttons simultaneously until awning motor jogs. See (FIG. 12).

7. Press the close (up arrow) or open (down arrow) button briefly to verify awnings motor direction. See (FIG. 12).

- a. If awning travels in the wrong direction, press and hold the stop button for approximately 3 seconds. Awning motor will jog momentarily.  
b. Press the close (up arrow) or open (down arrow) button briefly again to verify direction has been corrected.

 Do **NOT** attempt other programming until the awning motor direction is correct. Otherwise, a full reset will be required again (restarting from step (2), after first completing this procedure through step (12)).

8. Press and hold the open (down arrow) button until lead rail is in correct out limit position, and awning fabric edges are taut. See (FIG. 2) & (FIG. 12).

 You may adjust position up or down using remote, to ensure there is clearance between awning fabric and outer arm assemblies. See (FIG. 3).

Remote will stop awning motor if button is held longer than 10 seconds. If this happens, release button and press again until desired position is reached.

## SETTINGS AND ADJUSTMENTS

9. Press and hold the close (up arrow) and stop buttons simultaneously until awning motor begins to run. See (FIG. 12).

 This sets the awning out limit from step (8).

10. Press the stop button briefly to stop the awning motor's travel. See (FIG. 12).

11. With the awning motor stopped, press and hold the stop button until awning motor jogs. See (FIG. 12).

 This programs the awning out limit set in step (9).

12. Press the program button on back of awning remote. Awning motor will jog momentarily. See (FIG. 11).

 The Awning motor and remote will now be in "user mode". The close (up arrow) or open (down arrow) buttons on remote, no longer need to be held to move awning to closed or out limits.

13. Verify awning functionality. See "Operation" on page (4).

14. Reprogram wind sensor, and any additional awning controls and accessories (additional remotes, sensors, etc.). See "A. Reset Wind Sensor" on page (6) starting with step (2), and any applicable accessory instructions.

## BATTERY REPLACEMENT

### A. Remote

-  1. Remove cover screw and back cover from remote. See (FIG. 11).

2. Remove old Li-MnO<sub>2</sub> battery and discard. See FIG. 15.

3. Place and slide new Li-MnO<sub>2</sub> battery (type CR2430) into battery clip until fully engaged. See FIG. 15.

 Make sure battery's positive side is up.

4. Reinstall back cover onto remote, and replace and tighten cover screw securely. See (FIG. 11).

### B. Wind Sensor

 If awning is equipped with a wind sensor, it is located on inside surface of lead rail.

-  1. Slide sensor cover from sensor base. Then detach sensor from sensor cover. See (FIG. 8) & (FIG. 9).

2. Remove old alkaline batteries and discard. See (FIG. 10).

3. **NOTICE** Do **NOT** use rechargeable batteries (NiMH, NiCD, etc.). Disposable Lithium or Alkaline type batteries are recommended. Install new batteries (size AA) in wind sensor. See (FIG. 10).

 Make sure battery polarity is matched correctly to battery compartment. An LED will light momentarily (on circuit board) when new batteries are installed. See (FIG. 10).

4. Reattach wind sensor to sensor cover, and install onto sensor base securely. See (FIG. 8) & (FIG. 9).

## CLOSE AWNING MANUALLY (POWER FAILURE)

In case of power failure, it may be necessary to close awning manually.

**i** Rule out simple causes for power failure (RV disconnected from power, ignition/safety interlock, etc.), and review "Appendix A: Troubleshooting" on page (13) **BEFORE** attempting to close awning manually.

If faulty remote, power source failure, or connection issues are ruled out as the cause, then there may be an issue with the awning motor or motor wiring requiring service by a qualified service technician.

**After awning is closed manually, it will require service by a qualified service technician.**

When awning is in open position and 120 Vac power has been lost, perform the following procedure to close awning.

**i** This procedure requires a 3/8" wrench (or electric/cordless drill), and a flat bladed screwdriver.

- 1. ⚠️ WARNING ELECTRICAL SHOCK HAZARD.** Disconnect power from product before accessing wiring connections. There may be issues mimicking a power failure with electric current still present, or power may return unexpectedly. Failure to obey this warning could result in death or serious injury.  
Disconnect 120 Vac power from RV.
- Using a flat bladed screwdriver, disengage (2) tabs (starting with bottom tab) on LH end cap. Then remove from awning. See (FIG. 13) & (FIG. 14).

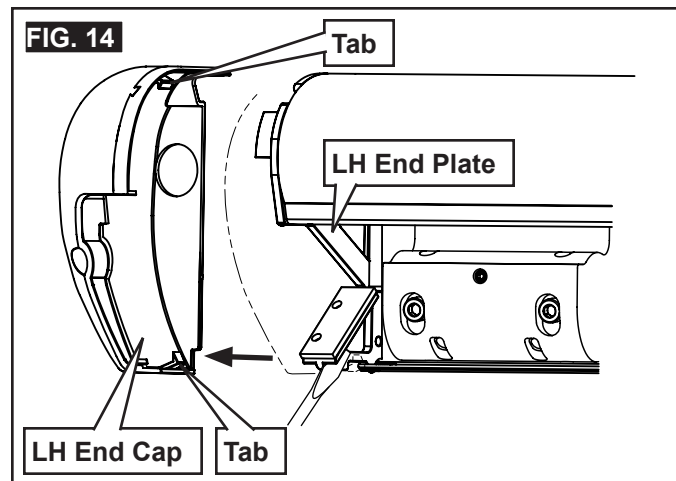
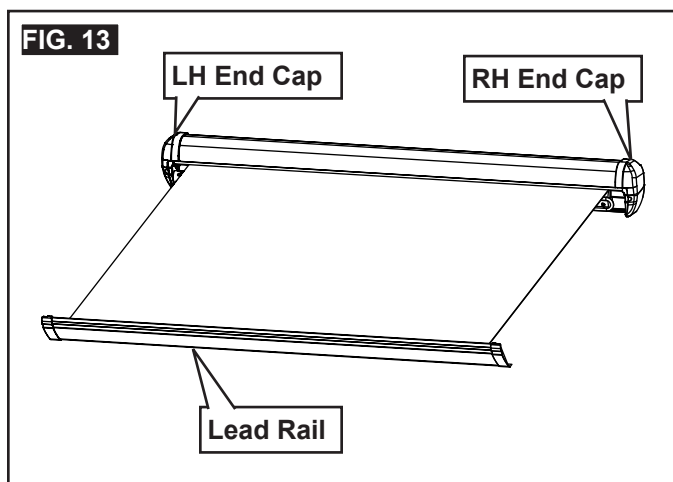

- 3. ⚠️ WARNING PINCH HAZARD.** Keep **CLEAR** of arm assemblies while closing awning. Arm assemblies will [fold / close] against back rail. Failure to obey this warning could result in death or serious injury.

Turn the hex rod at LH end plate clockwise until awning is closed. See (FIG. 13) and (FIG. 15).

**i** Awning may **NOT** close completely. Up to a 4" gap between lead rail and awning case may be expected.

This step will confuse the set limits, requiring limit reset(s) once power issue is resolved. See "D. Set / Reset Awning Intermediate Position" on page (8) and "E. Reset Awning Out Limit" on page (9).

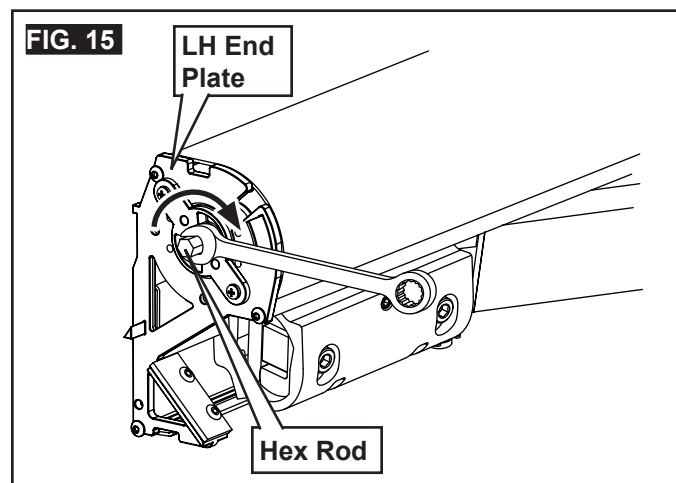

- Reinstall LH end cap onto awning. See (FIG. 13).

# GENERAL CARE AND USE

## A. Precautions

**NOTICE** Failure to obey the following notices could damage product or property:

- Do **NOT** use insecticides or other sprays near awning fabric. These could cause stains, and could adversely affect fabric's ability to repel water.
- Do **NOT** expose awning to adverse environmental conditions, corrosive agents, or other harmful conditions.
- Do **NOT** allow corner of entry door to contact awning fabric. Otherwise, premature wear or tearing of awning fabric could occur.
- **NEVER** close awning (for storage) when wet. The combination of moisture and dirt could result in mildew, discoloration, and stains.
  -  If it is necessary to roll up awning (temporarily) while it's wet, make sure you roll it out and let it dry (as soon as conditions allow) before rolling it up again.
- Do **NOT** allow dirt, leaves, or other debris to accumulate on awning, which could cause abrasion and stains. Mildew could grow on dirt and organic debris causing permanent discoloration, stains, and odors to awning fabric.

## B. Hardware Maintenance

-  1. **NOTICE** Do **NOT** use strong chemicals or abrasives to clean parts, as their protective surfaces will be damaged.

Clean awning hardware (as needed) with a mild surface cleaner (such as dish soap).
- 2. **NOTICE** Do **NOT** use silicone sprays near labels. Otherwise, the label's adhesive bond to product surfaces could weaken.

Apply silicone spray lubricant as needed to keep the fabric roller tube assembly's moving parts operating smoothly.
- 3. Lubricate all sliding surfaces of arm assemblies with silicone spray as needed.

## C. Fabric Maintenance

Vinyl fabric offers the advantage of durability and water resistance.

-  Wrinkling is a normal characteristic of vinyl. Wrinkling may be more noticeable when retracted, and after prolonged periods of stowing (rolled up). Leave awning open during warm weather to minimize the wrinkling over a period of time.

1. To clean:

-  a. Mix 1/4 cup dish soap and 1/4 cup bleach to 5 gallons of fresh water to use as cleaning solution.
- b. **NOTICE** Do **NOT** use abrasive or corrosive cleaners, mildew removers, or hard bristle brushes on awning fabric.



Liberally drench open awning fabric with cleaning solution.
- c. Close awning, let it soak for 5 minutes, then open awning again.
- d. **NOTICE** Remove solution **COMPLETELY** from awning fabric. Bleach will degrade awning fabric if **NOT** completely rinsed off.

Thoroughly hose off top and bottom of fabric with clean water.

  -  Repeat as necessary to completely remove solution.
- e. **NOTICE** **NEVER** close awning (for storage) when wet. The combination of moisture and dirt could result in mildew, discoloration, and stains.

Allow awning to dry thoroughly before stowing (rolling up).

2. To repair a pinhole, or if a spot of coating flakes off from top layer of vinyl fabric:

-  a. Apply a very small dab of VLP (Vinyl Liquid Patch) on tip of cotton swab.
  -  VLP is available from Dometic Corporation. Reference part number 3314216.000 when ordering.
- b. Gently roll cotton swab around pinhole. The VLP will melt the coating (on fabric) and that will quickly fill in pinhole and blend with all colored vinyls.
- c. **NOTICE** **NEVER** close (roll up) awning when vinyl liquid patch is wet. Otherwise, damage to other parts of awning fabric (melting through layers) will occur.

Allow VLP to dry thoroughly before stowing (rolling up) awning.

## D. When To Get More Help

If malfunctions occur (that cannot be corrected by reviewing these instructions), contact a qualified service technician.

-  A slight "travel line" may appear where door roller (if installed) contacts awning fabric. This is considered normal and does **NOT** affect the integrity of awning fabric.

# APPENDIX A: TROUBLESHOOTING

Wind Sensor		
Problem	Cause	Solution
Awning does not automatically close when windy conditions are present.	Wind sensor batteries are spent.	Replace batteries. See "Battery Replacement" on page (10).
	Wind sensor is not programmed to awning motor.	Reset wind sensor. See "A. Reset Wind Sensor" on page (6).
	Sensitivity setting is too low.	Adjust to appropriate sensitivity level using one of the following methods: Set potentiometer sensitivity according to a predefined threshold. See "B. Predefined Wind Sensor Adjustment" on page (7).
Awning automatically closes during light breezes.	Sensitivity setting is too high.	Set sensitivity to personalized preference. See "C. Personalized Wind Sensor Adjustment" on page (8).
Awning automatically closes after 30 minutes without windy conditions.	Wind sensor batteries are low. -Indicated by LED staying lit (on sensor circuit board).	Replace batteries. See "Battery Replacement" on page (10).
Awning automatically closes after 1 hour without windy conditions.	Wind sensor is missing, or installed incorrectly on sensor base.	Install wind sensor onto sensor base correctly. See "A. Reset Wind Sensor" on page (6).
	Wind sensor batteries are dead.	Replace batteries. See "Battery Replacement" on page (10).
	Wind sensor is damaged or defective.	Replace wind sensor.
LED (on sensor circuit board) does not light when new batteries are installed.	Wind sensor batteries are installed incorrectly.	Install batteries to correct polarity (direction). See "Battery Replacement" on page (10).



# APPENDIX A: TROUBLESHOOTING

Awning Motor And Remote		
Problem	Cause	Solution
Awning motor does not respond to awning remote.	Motor will not operate for approximately 30 seconds after awning is closed by wind sensor.	Power motor off then on to temporarily bypass delay.
	Remote batteries may be spent.	Press either the open or close button briefly to verify LED lights momentarily (on remote). If LED does not light, install new battery. See "Battery Replacement" on page (10).
	Remote is not activated (programmed to motor), or remote programming is corrupt.	If remote is added from a kit, see kit instructions to activate.
		Motor and remote may need to be reset. See "F. Reset Motor And Remote" on page (9).
	Awning is disconnected from power source.	Check all power connections.
	RV or power source breaker is tripped, or fuse is blown.	Reset breaker, or replace fuse as necessary. If this issue persists, contact a qualified service technician.
	A power line switch is off, or ignition disconnect switch is on.	Turn power line switch on, or ignition switch off.
	RV battery has discharged. (Applies only if inverter is installed.)	Recharge RV battery.
	Inverter has malfunctioned (if installed).	Connect to residential power source to verify awning functionality. Contact a qualified service technician.
Awning motor is damaged or defective.	Close awning manually, and contact a qualified Dometic service technician. See "Close Awning Manually (Power Failure)" on page (11).	
Awning motor travels in wrong direction when open (down) or close (up) button is pressed.	Remote programming for motor rotation is incorrect.	The motor and remote will need to be reprogrammed to change direction on remote. See "F. Reset Motor And Remote" on page (9).
Awning does not fully extend, or extends too far (fabric edge sags).	Awning out limit is set incorrectly.	Reset limit. See "E. Reset Awning Out Limit" on page (9).
Awning does not fully close, or lead rail moves out slightly after awning closes.	Awning back-release feature is enabled.	Disable back-release feature: Press and hold the open (down arrow) and stop buttons simultaneously until awning motor jogs.
		If back-release feature will not disable normally, a program reset may be necessary. See "F. Reset Motor And Remote" on page (9).