

Front Bumper Installation Instructions

P/N 210546: 2020+ Ford Transit Front Bumper

Before you begin:

- *Stainless steel hardware may bind together when tightening — apply an anti-seize assembly lubricant to the threads of each bolt before assembly (not grade 8 bolts)*
- *This installation requires two or more people*

Required Tools:

- Standard and metric wrench set
- Standard and metric socket set
- Flat head screwdriver
- Cut-off wheel
- Prybar
- Hammer



Included Hardware:

P/N	Description	Quantity
70036	Hex head bolt, 1/2"-13 x 1-1/2", grade 8	18
70035	Washer, 1/2" ID	34
70033	Nut, 1/2"-13 nylon-locking, grade 8	18
70029	Hex head bold, 3/8"-16 x 1-1/4", SS	8
70028	Washer, 3/8" ID, SS	16
70024	Nut, 3/8"-16 nylon-locking, SS	8
70060	Button head bolt, 1/4"-20 x 1", SS	4
70009	Washer, 1/4" ID, SS	8
70008	Nut, 1/4"-20 nylon-locking, SS	4
70246	Antiseize bolt lubricant packet, 2g	1

Additional Parts:

Description

Quantity

Picture

Aluminum Front Bumper

1

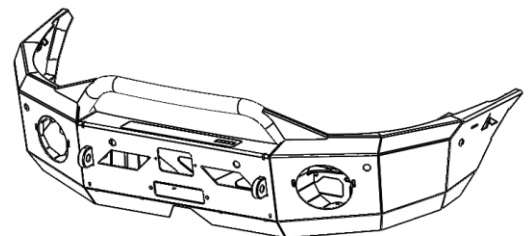

Winch Mounting Plate

1

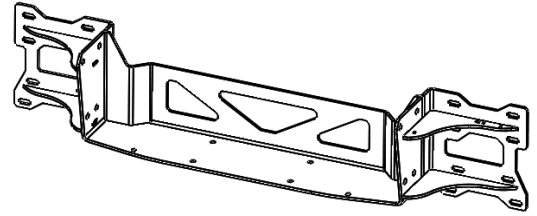

Front Sensor Bracket

1

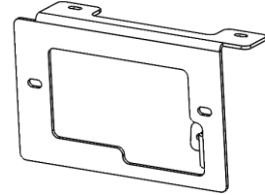

Outer support bracket - driver's side

1

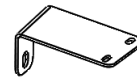

Outer support bracket - passenger's side

1



Stock Bumper Removal:

1. Open and secure the hood.
2. Remove the five (5) plastic rivets and four (4) 13mm bolts on the top of the grille (Figure 1).

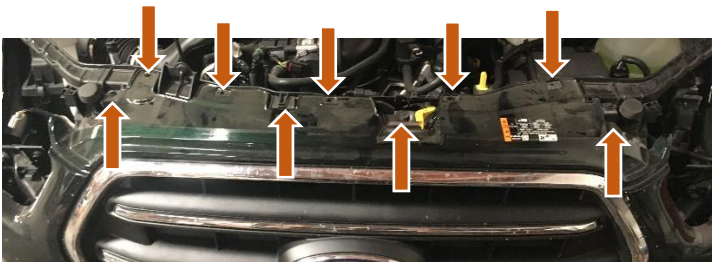

Figure 1: Plastic Rivets (Top) and Bolts (Bottom) to be Removed



Figure 2: Headlight Bolts

3. Remove the two (2) torx screws attaching each headlight. Once the bolts are removed, slide the headlight straight away from the vehicle, unclip wiring connectors, and remove the headlight (Figure 2).
4. Remove the two (2) torx bolts holding the front fascia to the vehicle sides and the one (1) 10mm screw holding the top of the factory bumper located in the back corner underneath the headlight (Figure 3). Remove the plastic backing plate (Figure 3).

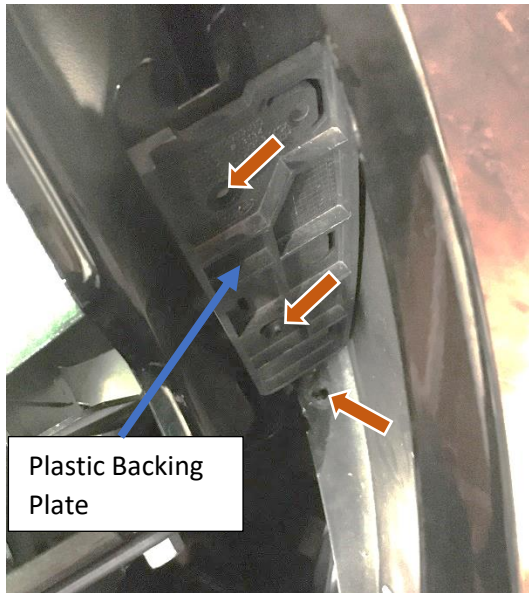

Figure 3: Hidden Bolts Underneath Headlights

- Remove the four (4) torx bolts inside the inner wheel well along the fender flare (Figure 4).

PRO TIP: Access to the bolts is made much easier by turning the vehicle's wheels.



Figure 4: Torx Bolts Along Inner Wheel Well

- Gently pull each fender flare away from the vehicle starting closest to the door. Once you reach the bumper, there are three (3) plastic catches that need to be released (Figure 5 & 6).



Figure 5: Fender Flare Removal



Figure 6: Fender Flare Plastic Clips Catches

- Pull the inner wheel well down and away from the bumper to gain access behind the plastic. Remove the 10mm bolt from inside the wheel well (Figure 7). NOTE: the two (2) torx bolts now visible on the bumper do not need to be removed.



Figure 7: Bolt Accessed from Inside of the Wheel Well

8. Remove the eight (8) 13mm bolts connecting the factory bumper to the under-carriage plastic (Figure 8).

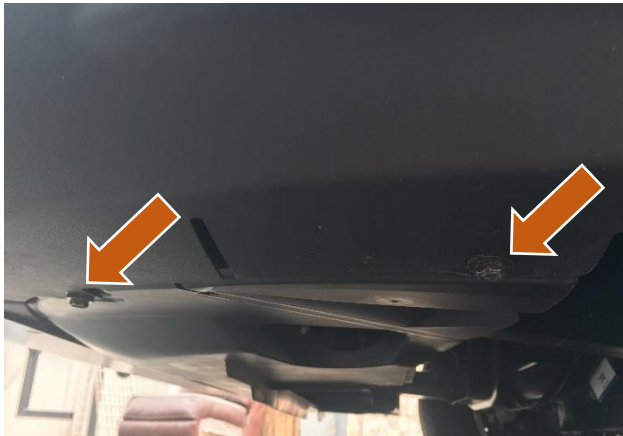

Figure 8: Bolts on Underside of Bumper

9. Remove the front license plate (if applicable). Remove the bolts or drill out the two or three (2-3) rivets attaching the license plate holder onto the factory bumper using a 1/4" drill bit.
10. Remove the now exposed bolt caps as applicable and remove the final two (2) 13mm bolts holding on the stock bumper (Figure 9).

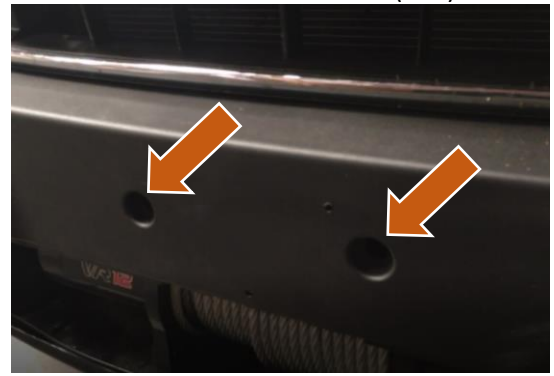

Figure 9: Front Bolts Underneath the License Plate Holder

11. Release the four (4) large plastic catches holding the grille onto the front of the vehicle (Figure 10 & 11). Note: it may be helpful to do in combination with the next step.



Figure 10: Locations of the Large Plastic Catches

NOTE: The middle two catches are underneath the top plastic cover of the grille as shown in Figure 10.

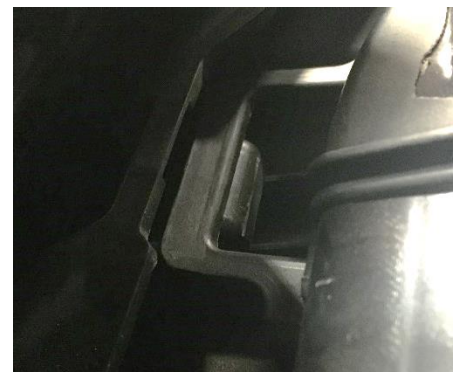

Figure 11: Close Up of Plastic Catch

12. Remove stock front bumper and grille by pulling directly away from vehicle, slowly working from the edges closest to the doors toward the center (Figure 12).



Figure 12: Factory Bumper Removal

13. Be sure to disconnect any sensors that are attached to the bumper during removal (Figure 13).



Figure 13: Sensor Being Disconnected

14. Separate the factory plastic bumper from the grille by use a plastic pry tool or a flat head screwdriver covered in masking tape. Release the bumper catches holding the bumper onto the front body panels underneath the headlight area (Figure 14).



Figure 14: Front Bumper Being Pried from Body

15. Remove all parking sensors from back of the plastic factory bumper (Figure 15).



Figure 15: Parking Sensors from Backside of Bumper

16. Remove the inner plastic radiator air deflectors (Figure 16 & 17) by removing all plastic push pins. Cut air deflectors to as shown (Figure 17).



Figure 16: Upper Push Pin Location

(Passenger Side Shown without Air Deflector)



Figure 17: Radiator Air Deflector with Cut Line Shown

17. Remove any and all sensors from the factory steel bumper:

- a. Temperature sensor (Figure 18).



Figure 18: Temperature Sensor Removed

- b. Collision prevention / adaptive cruise control sensor – unclip from sensor and remove all clips from steel (Figure 19).

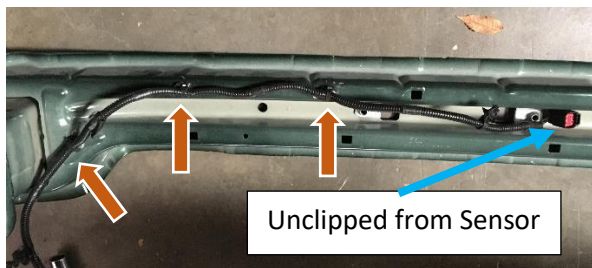

Figure 19: Front Radar Wiring Harness Removal

- c. Remove entire adaptive cruise control system from steel bumper (2X – 8 mm bolts and 1X – torx bolt) (Figure 20).



Figure 20: Front Radar and Bracket Uninstalled

- 18. Remove two (2) 10mm bolts holding on the plastic under-carriage and pull down to remove (Figure 21).



Figure 21: Under-Carriage Bolt

- 19. Remove the eight (8) 13mm bolts from the backside of the steel bumper (Figure 22).

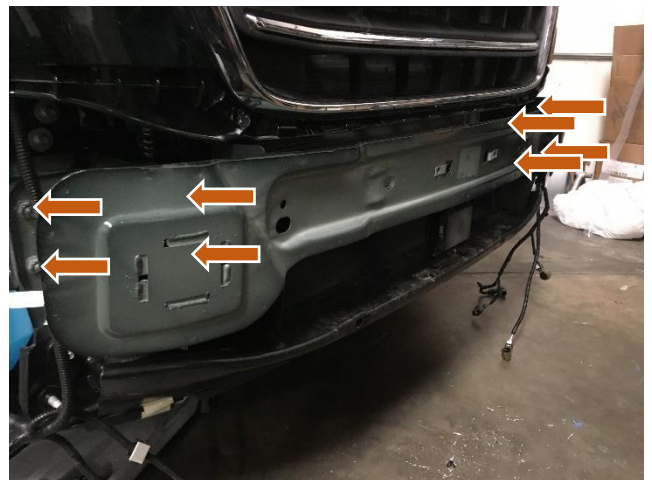

Figure 22: Factory Bumper Removal

20. Remove the 4 spot welds (2 per side) holding on the bumper to the frame (Figure 23). To remove, there are a couple of options:
- d. Drill out each spot weld
 - e. Gently pry the bumper away from the frame and use a Sawzall to cut weld
 - f. Use an angle grinder to grind the spot welds down enough to use prybar/hammer to remove.



Figure 23: Example of Spot Weld (Shown from the Back)

21. Remove eight (8) 13mm bolts to remove the lower factory scuff guard (black steel member; Figure 24).

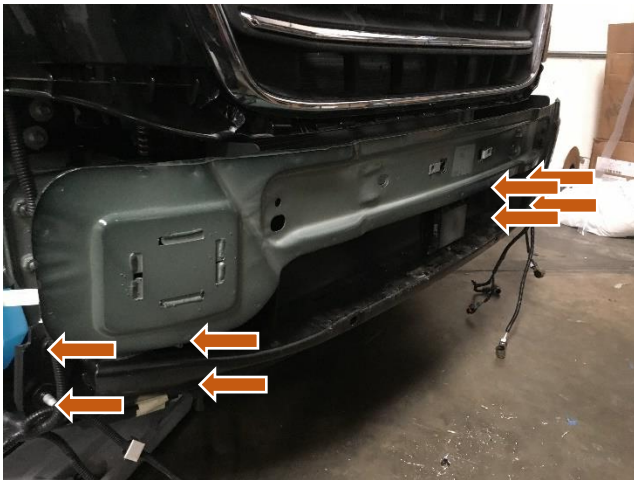

Figure 24: Lower Scuff Guard Removal

22. Separate any remaining wiring from the front of the frame and touch up any exposed metal surfaces with appropriate paint (Figure 25).

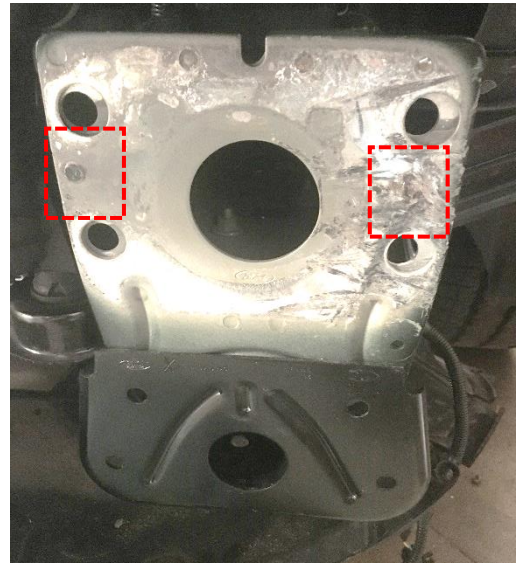

Figure 25: Exposed Metal From Bumper Removal

23. Cut the front radar bracket as shown in Figure 26 using a cut off wheel.

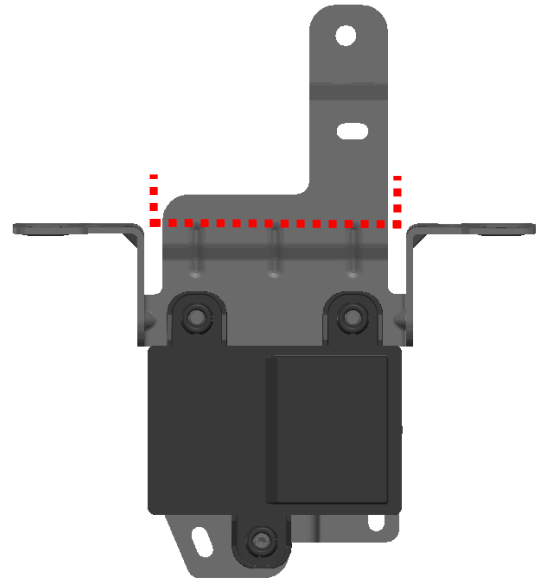

Figure 26: Cut Line for Front Radar Bracket

Front Bumper Installation:

24. Install the factory radar bracket onto the front sensor bracket using the provided 1/4"-20 hardware (Figure 27). Ensure the bottom bolt is pointed down to minimize the profile for the best fitment with a winch.

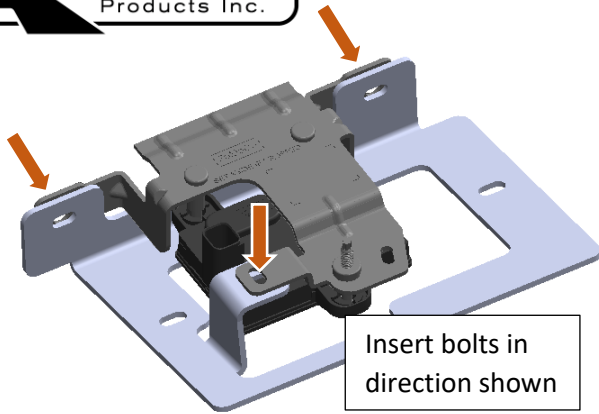

Figure 27: Front Radar Mounting to Aluminess Bracket

25. Install the now assembled radar sensor into the aluminum bumper behind the sensor window (Figure 28).

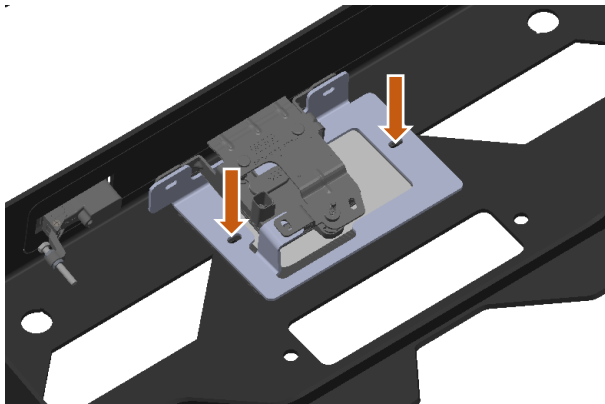

Figure 28: Radar Sensor Installed into Aluminum Bumper

26. Install the winch tray onto the frame using 1/2"-13 hardware through the top four (4) frame holes and 3/8"-16 bolts on the bottom four (4) scuff guard extension holes (Figure 29). Loosely install all 16 bolts through the frame/scuff guard and center the winch tray onto the vehicle before tightening. Once located, tighten the 1/2"-13 bolts to 80 ft-lbs and tighten the 3/8"-16 bolts to 20 ft-lbs.

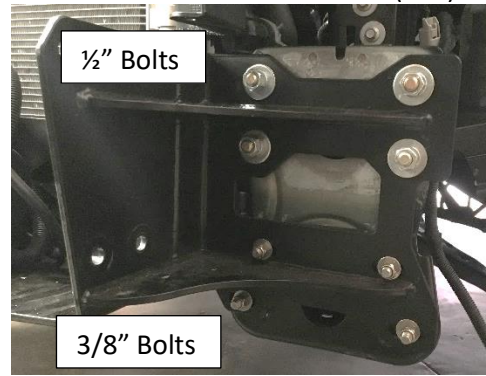

Figure 29: Winch Tray Installed onto Frame

27. Install winch onto winch tray per the manufacturer's instructions if desired (Figure 30).



Figure 30: Winch Installed onto Winch Plate

28. Install the plastic radiator air deflectors after being cut by reusing the top push pin (reference Figure 17 & 30).
29. Install the outer support brackets onto the corresponding driver and passenger sides using 1/2"-13 hardware (Figure 31 and 32).

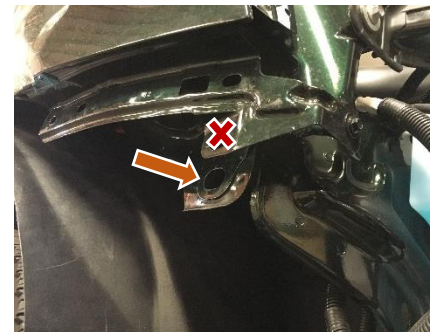

Figure 31: Location of Outer Support Bracket (Passenger Side Shown)

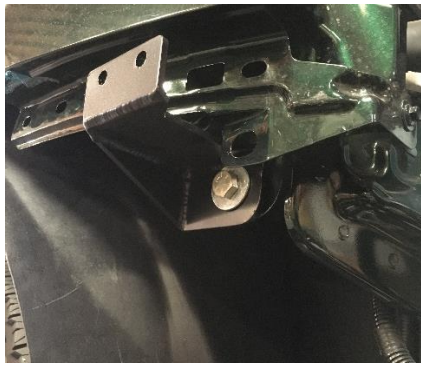

Figure 32: Outer Support Bracket Installed

(NOTE: prototype bracket shown)

30. If applicable, install the parking sensors into Aluminess front bumper using the Parking Sensor Upgrade Kit (P/N 210560) and by following the separately included instructions.
31. Install the aluminum bumper onto the winch plate and loosely fasten them together using the remaining 1/2"-13 hardware. There are four (4) holes on each side of the bumper and winch mount to bolt through (Figure 33).

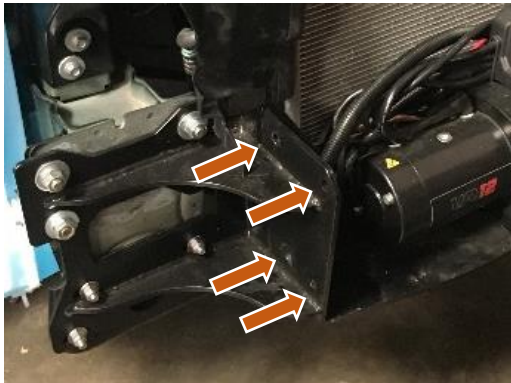

Figure 33: Aluminum Bumper to Winch Tray Mounting Locations

32. Position bumper into desired location and install 1/4"-20 hardware through the outer support gussets.
33. Tighten 1/2"-13 hardware to 80 ft-lbs.
34. Use 1/4"-20 bolts to attach the plastic wheel well liner to the side of the bumper (Figure 34).



Figure 34: Attachment Point for Wheel Well Liner

35. Reconnect all wiring harnesses back into sensors as applicable.
36. Measure and cut fender flares at the desired position against bumper, either just above, or just below the top surface of the bumper (Figure 35).

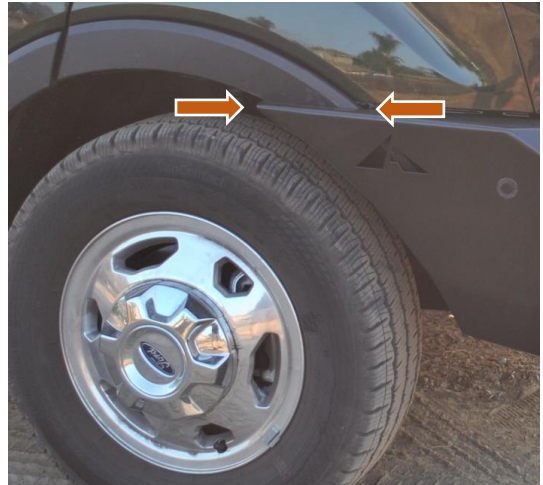

Figure 35: Fender Flares Reinstalled onto Vehicle

37. Re-install fender flares into position.
38. Your bumper is now installed! Verify all sensors are working correctly and adjust as needed. Check all hardware after the first 100 miles and periodically thereafter.



Aluminess Products, Inc. (Aluminess) Warranty

1. Lifetime Warranty. Aluminess provides a lifetime warranty of its products to the original retail purchaser provided such products are installed correctly according to the official Aluminess installation instructions. Any modification to the original product design, function or use of any Aluminess products will void the Aluminess warranty. Aluminess will have sole discretion to determine warranty eligibility for any and all Aluminess products sold to any purchaser.

2. Limited Remedies. Subject to any limitations and exclusions described herein, and subject to Aluminess' determination of warranty eligibility, Aluminess will remedy defects in product materials and/or workmanship of any product by repairing or replacing such defective product, which shall be within Aluminess' sole discretion, without charge for parts or labor. Aluminess may elect in its sole discretion not to replace a defective product and issue the purchaser a refund equal to the purchase price of any defective product or purchaser may elect to receive a credit (equal to such refund) toward the purchase of new Aluminess products. Repair or replacement of a defective product or providing a refund or credit to purchaser will be purchaser's exclusive remedy under this warranty. Damage to a purchaser's vehicle, cargo and/or any other person or property is expressly excluded from the Aluminess warranty.

3. Modification. Aluminess products are designed to be mounted to factory equipped vehicles. Aftermarket additions to such vehicle may or may not require modification of an Aluminess product. The Aluminess warranty does not extend to any Aluminess products that are modified to fit around other otherwise accommodate or be compatible with any aftermarket vehicle accessories or alterations. Aluminess does not guarantee fitment with any other aftermarket accessories or modified vehicle, and it is up to purchaser to determine fitment prior to purchasing any Aluminess product.

4. Damage. Damage to Aluminess products due to normal wear and tear, including, but not limited to, cosmetic issues and superficial scratches, or structural damage to an Aluminess product in connection with any vehicle collisions or other structural degradation in connection with the use of such vehicle (on road or off road) will not be covered by the Aluminess warranty. Additionally, any product user's misuse, neglect, overloading, improper maintenance or improper installation or repair of any Aluminess products are not covered under the Aluminess warranty.

5. Use of the Products. Aluminess products are designed for off road vehicle use. Installing Aluminess products on a vehicle may exceed the factory designed capabilities of such vehicle and could potentially lead to vehicle damage. Aluminess will not be responsible for any damage caused to a purchaser or user's vehicle or any vehicle accessories caused by the use of any Aluminess products. It is to the sole responsibility of purchaser to inspect and ensure that the intended vehicle and Aluminess products are suitable and compatible for travel on road and off road. No seller nor any manufacturer of Aluminess products will be liable for any loss, damage or injury directly or indirectly arising from the use of any Aluminess products. Before using any Aluminess products, the purchaser or user will determine the suitability of the product(s) for their intended use(s) and the purchaser or user shall assume all responsibility and risk in connection therewith.

6. DISCLAIMER. THE ALUMINESS WARRANTY IS EXPRESSLY MADE IN LIEU OF ANY AND ALL OTHER WARRANTIES, AND EXCEPT FOR THE ALUMINESS WARRANTY SET FORTH HEREIN, ALUMINESS MAKES NO WARRANTY WHATSOEVER WITH RESPECT TO ANY ALUMINESS PRODUCT, INCLUDING ANY WARRANTY OF MERCHANTABILITY AND FITNESS FOR A PARTICULAR PURPOSE, WHETHER EXPRESS OR IMPLIED BY LAW, COURSE OF DEALING, COURSE OF PERFORMANCE, USAGE OF TRADE, OR OTHERWISE.

EXCEPT FOR PURCHASER'S LIMITED REMEDIES SET FORTH HEREIN, IN NO EVENT WILL ALUMINESS BE LIABLE FOR ANY LOST PROFITS, LOST SALES, OR FOR ANY CONSEQUENTIAL, DIRECT, INDIRECT, INCIDENTAL, SPECIAL, EXEMPLARY OR PUNITIVE DAMAGES OR FOR ANY OTHER DAMAGES OF ANY KIND OR NATURE.

7. Compliance. Aluminess cannot guarantee that its products comply with all Federal, State, and/or local laws. Purchaser is advised to review local vehicle codes for compatibility prior to purchase to ensure that the installation and use of any Aluminess products does not violate any applicable laws.

8. Warranty Claim Submission. Purchaser will responsible for returning any defective product to Aluminess for warranty consideration and purchaser may be responsible for all costs associated with shipping the product to and from Aluminess. Prior to returning any product for warranty, purchaser must contact Aluminess Products Inc. for proper authorization.