

X *GYRO REMOTE CONTROL SERIES* **2.4G** **5UW (720P)**

4-CHANNEL PRESSURE HOVERING HEIGHT-ADJUSTMENT REMOTE CONTROL 6-AXIS FLYCOPTER

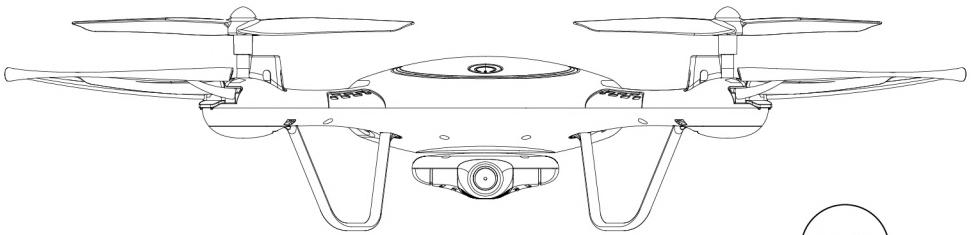

BC

2

USER MANUAL

OPERATING STANDARDS: GB/T26701-2011

MAIN FEATURES

- Utilizes the 4-axis structure, enabling the aircraft to be even more flexible, speedy, and possessing a relatively stronger wind-withstanding capability. Also it can conduct flights in interior as well as exterior environment.
- A 6-axis gyro direction stabiliser is built-in, ensuring precise positioning in the air.
- The structure uses modular designs, making installation simple and repair and maintenance easier.
- Capable of 360° 3D overturning function.
- Headless function is enabling the aircraft to be summoned back with ease.
- Brand new pressure hovering height-adjustment function.
- HD wifi real-time transmission aerial.
- New functions increased are auto take-off and landing .

The content, specifications or accessory packaging of internal products in this user manual is strictly for reference only. Our company will not be responsible for errors in the printed contents and it will not be able to proactively notify the consumers. For any updates or errors, please abide by the SYMA MODEL AIRCRAFT's website as accurate.

Safety guide

1. Please store the smaller-sized aircraft accessories in places that are out of reach of children, in order to avoid the occurrence of accidents.
2. This aircraft is very powerful. For all first-time flight, it shall be observed that the left gear shift joystick must be slowly pushed in order to prevent the aircraft from ascending too quickly and result in unnecessary collision and damages.
3. When the flight is ended, the power supply of the remote control shall be switched off firstly, and then, followed by the switching off of the power supply of the aircraft.
4. Avoid placing the batteries in places with high temperatures and exposure to heat (for example, naked light or electrical equipment installations).
5. Take extra precaution to ensure that the aircraft is at a distance of 2 to 3 metres from the user or other people in order to prevent the aircraft from colliding into the head, face or body, etc. of other people during landing.
6. When young children are operating the aircraft, it shall be ensured that the adults are guiding and making sure that the aircraft control is within the viewing range of the controller (or instructor) such that it makes the control very convenient.
7. Non-rechargeable batteries are prohibited for recharging. When installing or changing the batteries, please take extra care on the polarities of the batteries; mixing new and old batteries or different types of batteries are strictly disallowed.
8. When the aircraft is not in use, please switch off the power supplies of both the aircraft and the remote control, and remove the batteries in the remote control.
9. The terminals & power supply cannot be short-circuited.

Repair and maintenance

1. Always use dry and soft cloth to clean this product.
2. Avoid this product to be exposed to sunlight or heat.
3. Avoid immersing these toys into water, otherwise ,the electronic parts may be damaged.
4. Regularly Check and inspect the plug and other accessories. If any damages are discovered, please immediately stop using it, until it is completely repaired in good working condition.

Package description

The following items can be found in this product package:

- Aircraft
- Remote Control
- Main Blade
- Instruction Manual
- Screwdriver
- Protection Gear
- Card Reader
- USB Charger
- Mobile Phone Retaining Clip

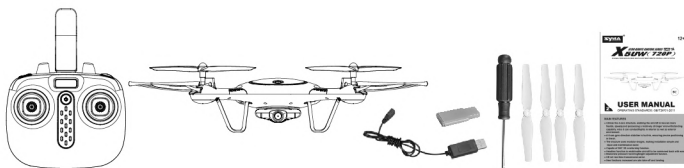

Installation procedures for foot stand

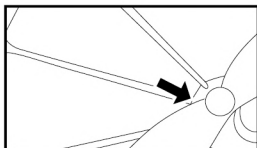

1. Install the protective gear into the main body as shown in.

Wifi camera installation and dismantling methods

Wifi camera installation procedures:

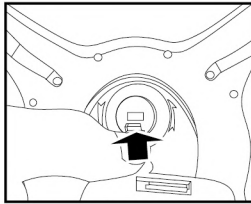

1. Insert the camera's connector wire into the interface on the main body.

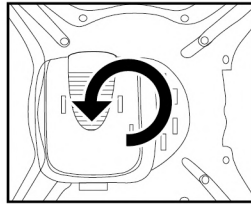

2. Aiming the camera at the interface on the main body and rotating the camera in anti-clockwise direction to make it screwed.

Wifi camera dismantling procedures:

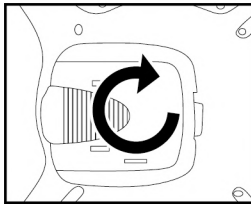

1. Rotating the camera in the clockwise direction.

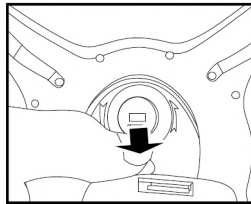

2. Then taking out the camera upward and pulling out the connector wire on the main body connected by the camera.

Wifi real-time transmission aerial photo-taking component installation

Mobile phone retaining clip installation:

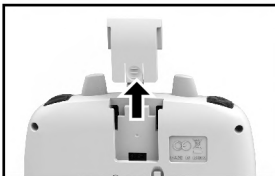

1. Pressing on the mobile phone clip cover behind the remote control and pushing it out upward.

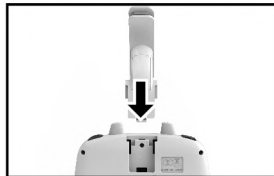

2. Align the mobile phone retaining clip with the antenna of the remote control and insert it in.



3. Use strength to press against the spring section of the retaining clip to adjust the size.

Battery changing and charging methods for aircraft

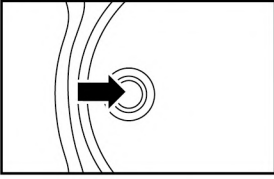

1. Pressing on the power switch on the top of the aerobat to make sure the aerobat in the state of "OFF".

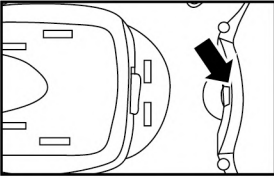

2. Pressing on the fixed components at the bottom of the battery and pulling out the battery.

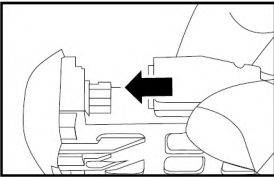

3. Connect the power supply line of the battery with USB, and connect the USB interface with the computer's connection port (During charging, the light indicator will light up; and the light indicator will go off when it is fully charged. The completion time for charging the battery is less than 130 minutes).

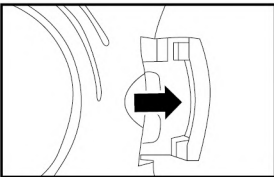

4. After changing the batteries, firmly secure the battery cover again.

The charging time is less than 130 minutes; In hover flight conditions longer than 7 minutes!

Precautions as follows during charging of battery:

- Avoid placing the active batteries in places with direct exposure, sunlight and high temperatures. For example, naked light or electrical equipment installations; otherwise it may cause damages or explosions.
- Avoid immersing the batteries in the water. The batteries shall be stored in a cool and dry place.
- Avoid dismantling the batteries.
- During the charging of battery, avoid leaving the charging place.

Understanding your remote control

Remote control's button function description:

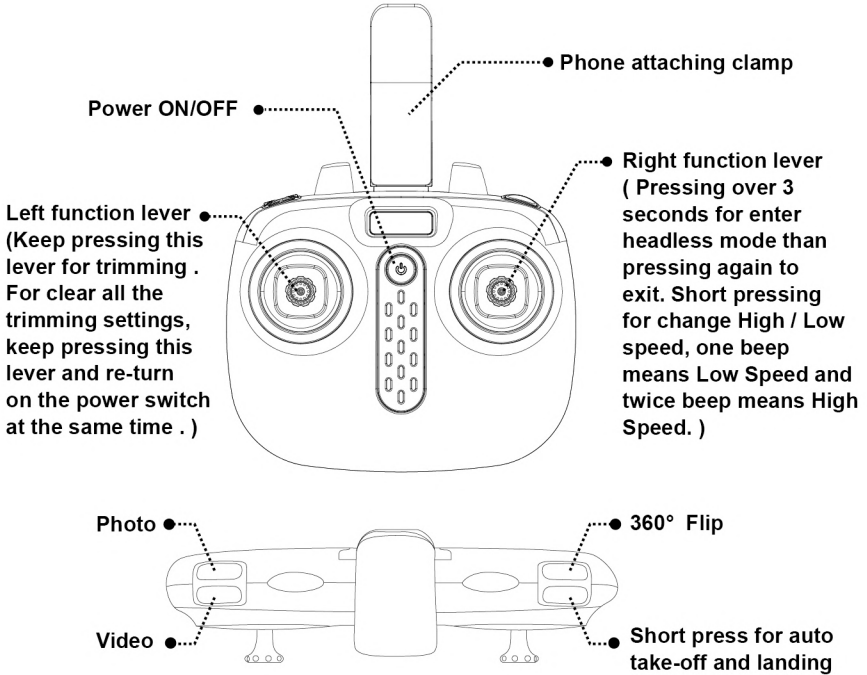

Battery installation for remote control:

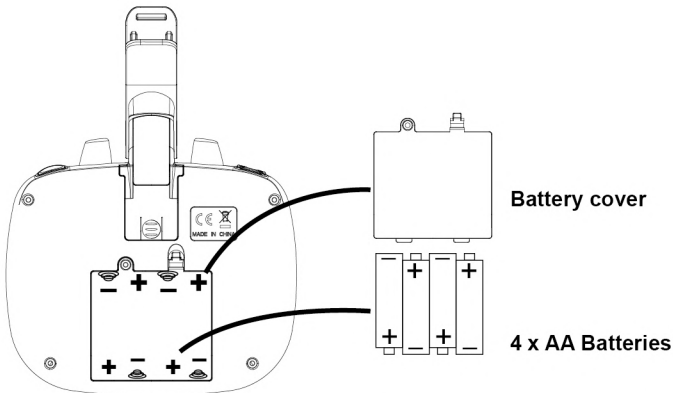

1. **Battery Installation Method:** Open up the battery cover at the back of the remote control. Correctly place 4 x AA alkaline batteries in the battery box in strict adherence to the polarity instructions (the batteries are optional).



1. During the battery installation, it must be ensured that the polarities of the batteries are matched with that of the battery box. No battery shall be installed with the opposite polarity.
2. Please do not use new and old batteries together.
3. Please do not use different types of batteries together.

Flight preparation and switching off of the aircraft

1. Flight preparation

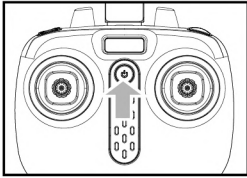

Step 1: Open up the power supply switch of the remote control.

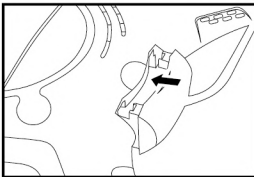

Step 2. Install the aerobat battery in place.

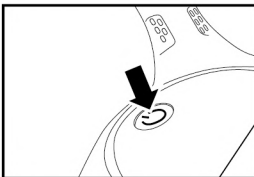

Step 3. Pressing on the power switch on the top of the aerobat to make sure the aerobat in the state of “OFF”.

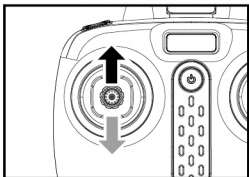

Step 4: Push the left lever (accelerator) to the highest point and then reset to the lowest point. When the indicator lights in the aircraft change from quick flashing to the continuous lighting, it means that the aircraft goes into the flight standby mode.

2. Switching on the aircraft

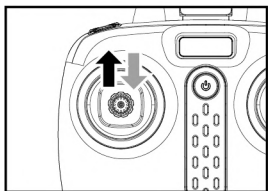

Method 1: push the left lever (accelerator) to the highest point and then reset to the center, the ventilation blade of aircraft starts rotating slowly.

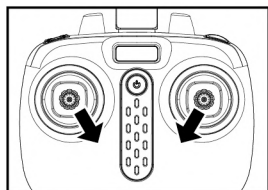

Method 2: Move the left and right joysticks inwards in an internal loop of “8” for 1 second, the ventilation blade of aircraft starts rotating slowly.

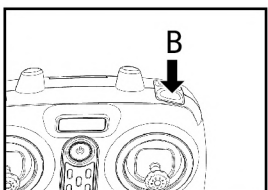

Method 3: When the vehicle is stationary, press the B button, the vehicle slowly rotating blades, automatically rises to a certain height.

3. Switching off the aircraft

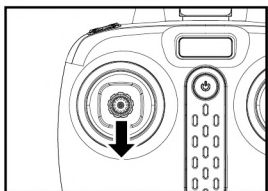

Method 1: Push the left joystick (Accelerator) to the lowest level and stay there for 2 to 3 seconds, the aircraft can then be switched off.

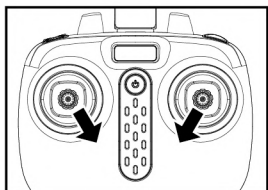

Method 2: Move the left and right joysticks inwards in an internal loop of “8” for 1 second, and the aircraft can be switched off.

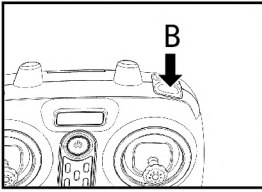

Method 3: When the aircraft is in flight, press the B button, the aircraft fell to the ground and slowly closed the aircraft.

Aircraft controlling diagram

Operating direction

Ascending and descending control

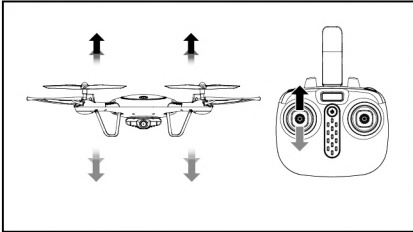

When the left joystick (Accelerator) is pushed upwards or downwards, the aircraft will ascend or descend correspondingly.

Forward and backward control

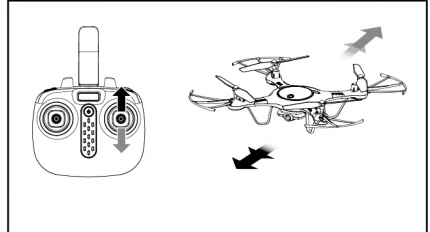

When the right joystick (Turning Rudder) is pushed upwards or downwards, the aircraft will advance forward or backward correspondingly.

Left turning and right turning control

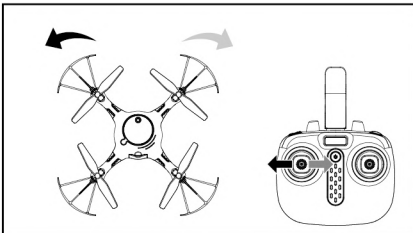

When the left joystick (Accelerator) is pushed towards the left or right, the aircraft will turn left or right correspondingly.

Left side flying and right side flying control

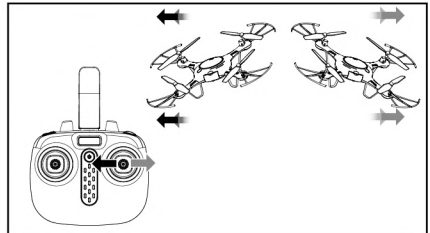

When the right joystick (Turning Rudder) is pushed towards the left or right, the aircraft will fly sideward on the left or right correspondingly.

Fine-tuning operation

Forward and backward fine-tuning control

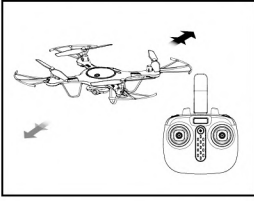

Under the condition aerobat hovering in the air when aerobat automatically flies forward/backwards, one could press down the left operating arm and at the same time push the right operating arm forward/backward to adjust the direction. Don't unloose the left operating arm until aerobat comes into a stable state.

Left/right side flying fine-tuning control

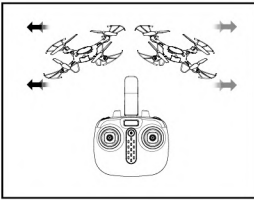

Under the condition aerobat hovering in the air when aerobat automatically flies towards the left/right side, one could press down the left operating arm and at the same time push the right operating arm to the right/left to adjust the direction. Don't unloose the left operating arm until aerobat comes into a stable state.

Left/right side turning fine-tuning control

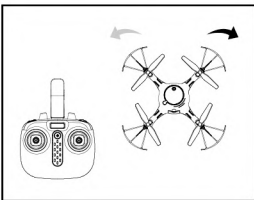

Under the condition aerobat hovering in the air when aerobat automatically rotates and flies towards the left/right, one could press down the left operating arm and at the same time push the left operating arm to the right/left to adjust the direction. Don't unloose the left operating arm until aerobat comes into a stable state.

Product features

1. Low-voltage protection:

When the four indicator lights at the bottom of aircraft start flicking, it means that the aircraft's battery power is low. At this time, the aircraft will initiate the height-limiting function and will drop to certain safety height.

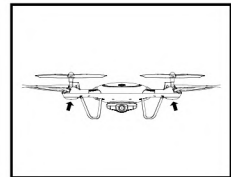

2. Overcurrent protection:

When the aircraft encounters direct impact from foreign object or is stuck under the circumstances in which its blades are rotating, the electric circuit of the aircraft will enter into the overcurrent protection mode.

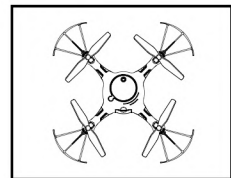

3. Level calibration function:

Place the aircraft on a levelling surface and at the same time, push both left and right joysticks to the lower right corners and stay there for 2 to 3 seconds; the normal light indicator on the aircraft will blink rapidly, and it will return back to the normal status after about 2 to 3 seconds. The level calibration is successful.

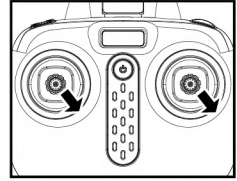

4. Fast/slow gear function:

Slow gear by default on power-on. Possible to switch the function mode of fast/slow gear by pressing on the operating arm on the right side for a short time. It is switched into fast gear mode when two “di di” sound come from the remote control, pressing on the operating arm on the right side for a short time under fast gear mode and then one “di” sound would come from the remote control, then it is then switched back into slow gear mode.

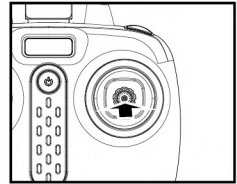

5. 360° flip function:

When you are familiar with the basic actions, you can proceed to explore even more exciting and risky overturning actions. Fly the aircraft to a height of above 3 m from the ground, press against the upper right corner button (Overturning Button) on the remote control and simultaneously push the right joystick to the highest level of Front/Back/Left/Right, the aircraft will now be executing the Front/Back/Left/Right overturning function.

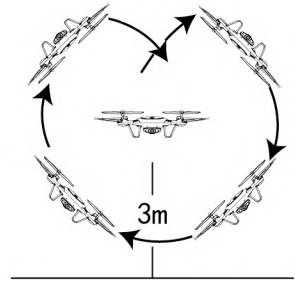

Note: When the batteries are fully charged, it will have the best overturning effect.

6. Pressure hovering height adjustment function:

After using the left joystick (Accelerator) to control the ascending / descending flight of the aircraft, free up the left joystick (Accelerator) and the aircraft will still hover at that height when the joystick is freed.

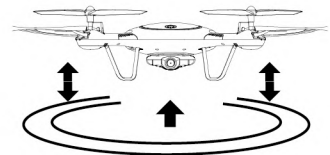

7. Headless function:

1. Defining forward direction:

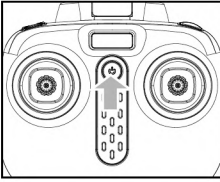

1. Open up the power supply switch of the remote control.

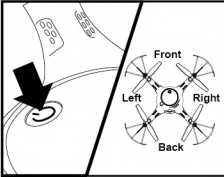

2. After connecting the aircraft to the power supply, push the switch to "ON" location, and adjust the specified direction of the aircraft's head under the headless mode as the new forward direction.

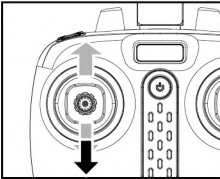

3. Push the accelerator joystick of the remote control to the highest level and then, pull back into the lowest level. When the remote control issues a long beep sound, it means the frequency and defining forward direction functions are completed.

2. Toggling between headless function and normal function:

1. After the aerobat matched with the corresponding frequency, the aerobat would be in normal pattern by default. At this time the indicator light on the aerobat would be in a state of on for a long time. After pressing on the right operating arm of the remote control for 2 seconds, the remote control would make a sound of "di, di, di,..." to show that it has entered into a state of , pressing on for 2 seconds then a long sound of "di" would be heard to show an exit status. (When under the state of , four indicator lights on the aerobat are recording lights which flicker once every four seconds)

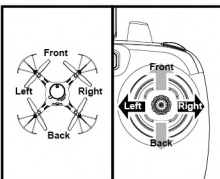
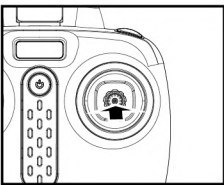

2. Under the headless mode, the operator does not require to differentiate the head position of the aircraft, and he just needs to control the aircraft using the joystick's direction of the remote control.

3. Rectification for the defining forward direction function:

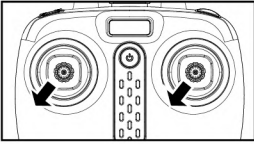

1. When the aircraft encounters a direct impact with foreign objects in the headless mode, if there is an occurrence of deviation of the defined direction, it is only required to push the accelerator and the direction joystick to the left bottom corners simultaneously after rectifying the flying direction of the aircraft in the correction direction. When the light indicator of the aircraft is in a long "ON" mode after slowly blinking for 3 seconds, it indicates the rectification is complete.

Wifi real-time transmission aerial photo-taking component installation

1. Download the installation software:

For Android mobile phones, please kindly (visit www.symatoys.net) or scan the QR code to download the SYMA GO installation software.

For Apple mobile phones, please kindly proceed to APP STORE to download the SYMA GO installation software or scan the QR code to download the SYMA GO installation software.

Warm reminded: Two-dimension code is provided in color box packing and back cover of specification to scan. Please concern official website APP STORE of SYMA or the latest reminder of Google play to acquire the latest SYMA GO.

2. Connection description:

1. Connect the module power, the indicator light on the WIFI camera will be constantly on, and wait about twenty seconds, then connect it to mobile phone.
2. After connected, go to the set menu and open the WIFI switch on mobile phone. Then find the available WIFI name of FPV_WIFI_XXXX in the list, click it to connect, wait until the phone shows the words 'connected', which means successfully connection, after this, exit from the set menu.
3. open the software SYMA GO, click the icon "START", then the system will identify automatically and enter the live transmission interface/APP operation interface. When the WIFI signal is full, the signal strength is best.



1. Open up SYMA GO software.

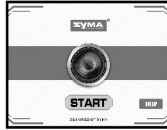

2. Click the "START" icon, the system will enter the live transmission interface/APP operation interface automatically.



3. The mobile phone screen displays with real-time imaging scenarios.

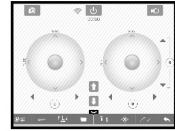

4. The mobile phone screen displays with APP control scenarios.

3. Interface icon instructions

Montior Instruction

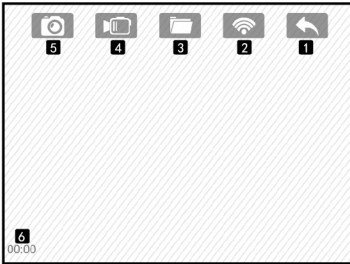

1. Back
2. WIFI's Signal
3. Checking of Photos and Videos
4. Video Recording
5. Photograph
6. Video Recording Time Display

Control Instruction

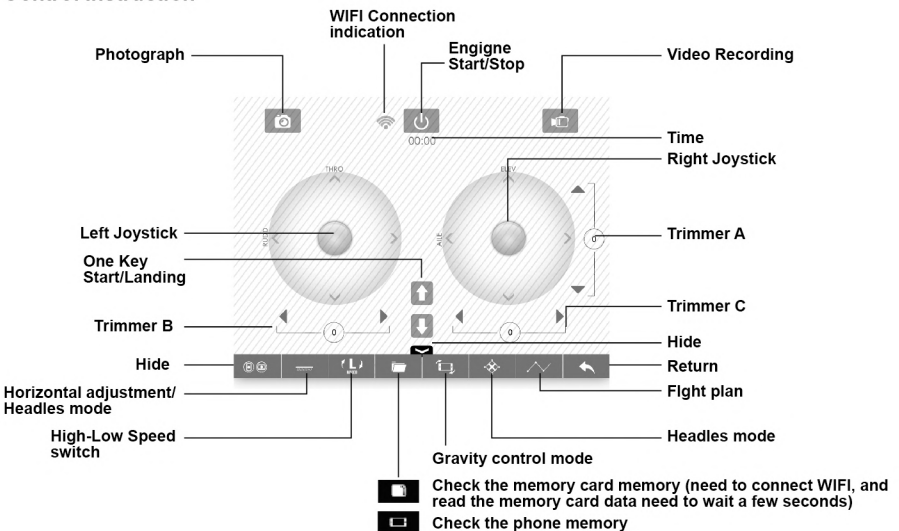

Flight-track operation interface

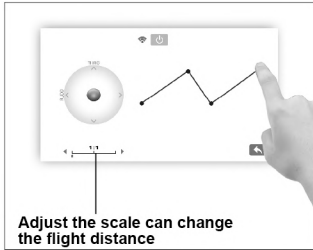

Press the flight-track button to enter into the flight-track interface, and the air vehicle will flight in accordance with recorded route.

4. Real-time transmission aerial photograph

Photograph and Video Recording: When the WIFI camera is operating in normal conditions, please click on the photo or video icon on the real-time transmission GUI, and immediately you can conduct photograph or video recording. (The completed files for photograph or video recording can be found in the “Checking of Photos and Videos” files.)

Note: When activating the mobile phone software to conduct real-time transmission operating mode, the flight distance of the aircraft will be shortened by half!

5. Memory card storage function.

This 720P WIFI camera has the function of memory card storage. When 720P WIFI camera has the memory card, mobile phone and memory card will store pictures/videos simultaneously. When 720P WIFI camera has no memory card, pictures/cards are only stored in a mobile phone.

Accessories (Optional)

You can choose your favourite optional accessories as below. In order to make it easier for the customers to choose and purchase, we have specially offered each and every accessory. The accessories can be purchased through the local distributors. Please kindly specify the colours during your purchase.

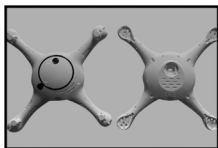

Main Body



WIFI Camera

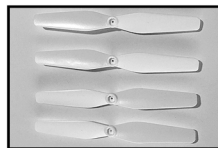

Rotor Blade

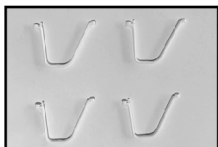

Base Stand



Protective Gear

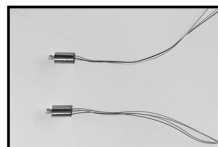

Motor

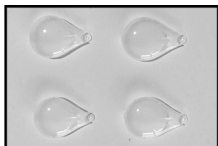

Lamp Cover



Light Bar

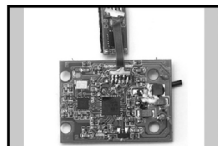

Receiver Board



Battery

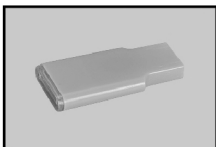

Card Reader

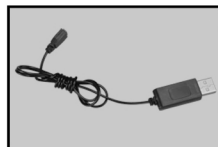

USB

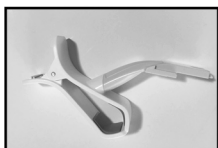

**Mobile Phone
Fixed Mounting**



Remote Control



Plating Object



Battery Holder

Product descriptions

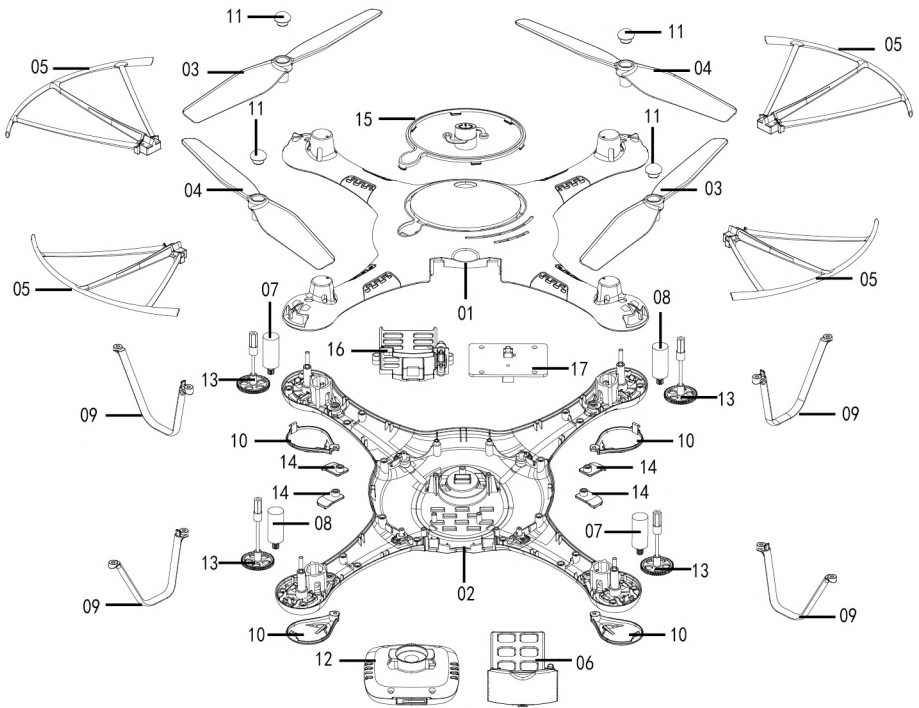

NO.	Product Name	Qty.	NO.	Product Name	Qty.
01	Top Main Body	1	10	Lamp Cover	4
02	Bottom Main Body	1	11	Blade Cover	4
03	Main Blade(Clockwise Direction)	2	12	Camera	1
04	Main Blade(Anti-clockwise Direction)	2	13	Gear	4
05	Protective Gear	4	14	Protective Gear Fitting	4
06	Battery	1	15	Main Body Fitting	1
07	Main Motor(Clockwise Direction)	2	16	Battery Cover	1
08	Main Motor(Anti-clockwise Direction)	2	17	Circuit Board	1
09	Foot Stand	4			

Main specifications

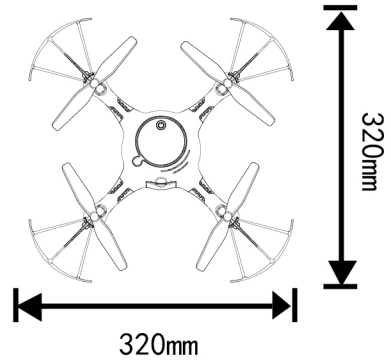
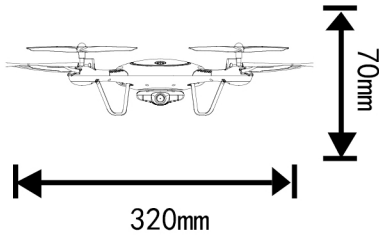

Aircraft's Length:320mm Aircraft's Width:320mm
Aircraft's Height:70mm Motor's Model: Ø8X16
Battery: 3.7V/500mAh lithium battery



SPECIFICATIONS AND COLORS OF CONTENTS MAY VARY FROM PHOTO.



**QR code for android
system**



**QR code for apple
iOS system**

**The company has the right of final interpretation
of this instruction manual statement.**