

---

## 43.5" x 22" Sit-Stand Desktop Workstation

### Instruction Manual

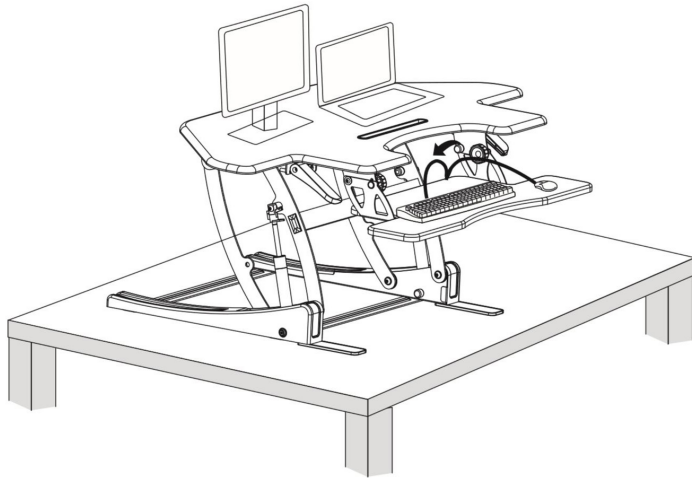

**SKU: DESK-V000VC**



Scan the QR code with your mobile device or follow the link for helpful videos and specifications related to this product.

<https://vivo-us.com/products/desk-v000vc>



help@vivo-us.com



www.vivo-us.com



1-800-371-5654

**⚠ WARNING!**

If you do not understand these directions, or if you have any doubts about the safety of the installation, please call a qualified technician. Check carefully to make sure there are no missing or defective parts. Improper installation may cause damage or serious injury. Do not use this product for any purpose that is not explicitly specified in this manual and do not exceed weight capacity. We cannot be liable for damage or injury caused by improper mounting, incorrect assembly, or inappropriate use.

**PACKAGE CONTENTS**

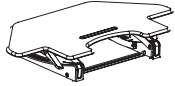

**A (x1)**  
Desktop



**B (x2)**  
Extended Feet



**C (x10)**  
M5x6 Screw



**D (x6)**  
M5x12 Screw



**E (x1)**  
Cable Clip



**F (x2)**  
Ziptie



**G (x1)**  
Keyboard Tray



**H (x2)**  
Bracket

**TOOLS NEEDED**



Phillips  
Screwdriver

**⚠ WARNING  
PINCH POINT**

DO NOT place hands on or near support bars. Moving parts can crush and cut. Pinch points are created during lifting and lowering the worksurface. Failure to follow these instructions may result in serious personal injury.



DO NOT EXCEED WEIGHT CAPACITY.  
Failure to do so may result in serious injury.



**ASSEMBLY STEPS**

**STEP 1**

Carefully remove the desktop (A) from the packaging and flip the desktop (A) onto a flat surface. Attach the extended feet (B) to the frame using screws (C).

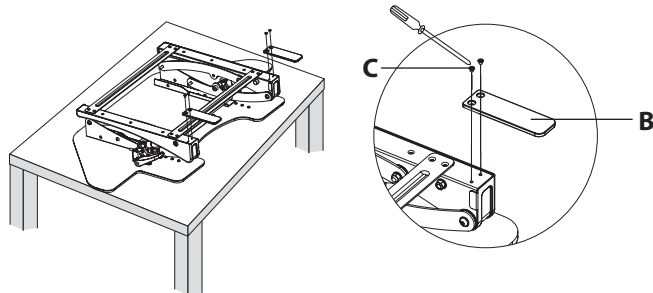

**STEP 2**

Press the handles on each side and lift the desktop (A).

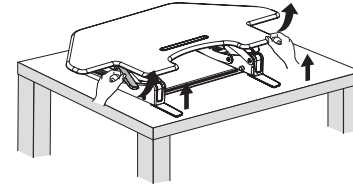

**STEP 3**

Mount brackets (H) to keyboard tray (G) using M5x6 screws (C). Mount keyboard tray to desk using M5x12 screws (D).

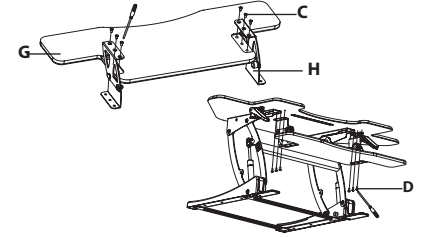

**STEP 4**

Place laptop, monitor, and other items on desk surface. Attach cable clip (E) to desk to manage keyboard and mouse cables. Manage cables using cable zipties (F).

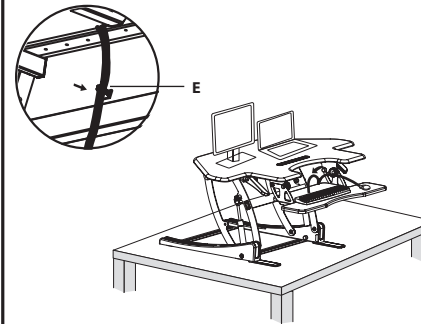

**STEP 5**

If locks are not releasing properly to change desk height, adjust the position of the black tube containing the steel release cable. Turn the nuts at the end of the tube just behind the handle as shown, moving the tube away from the handle until the cable once again has proper tension, then tighten the nuts.

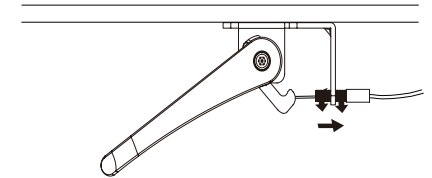

**⚠ CAUTION!**



Keep monitor and laptop base fully on the desktop.

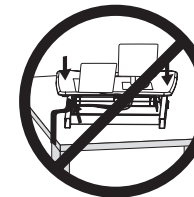

Follow the cable routing instructions to avoid the potential to pinch cables.



Leave enough slack in cable to allow for full range of vertical motion (15" / 38 cm).



Raise desktop slowly to keep items stable.

Failure to follow these instructions may result in property damage and/or personal injury.



Love your new VIVO setup and want to share?

Tag us in your photo! **@vivo\_us**

Last Updated: 10/12/2018



If any parts are received damaged or defective, please contact us. We are happy to replace parts to ensure you have a fully functioning product.



[help@vivo-us.com](mailto:help@vivo-us.com)



[www.vivo-us.com](http://www.vivo-us.com)



1-800-371-5654

For more VIVO products, check out our website at:  
[www.vivo-us.com](http://www.vivo-us.com).