

---

## 38" x 18" Sit-Stand Desktop Workstation

Instruction Manual

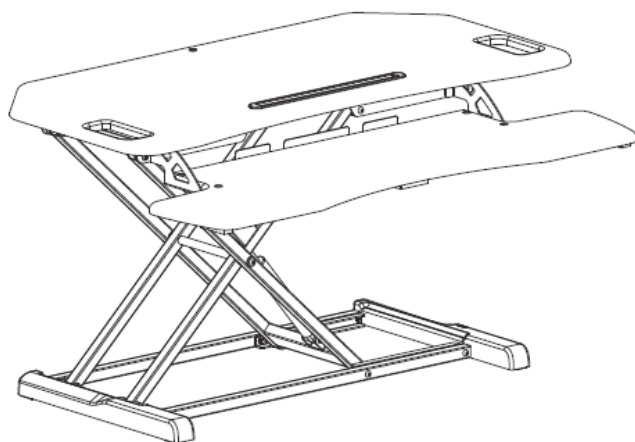

**SKU: DESK-V000KL**



Scan the QR code with your mobile device or follow the link for helpful videos and specifications related to this product.

<https://vivo-us.com/products/desk-v000kl>



help@vivo-us.com



www.vivo-us.com



1-800-371-5654

**WARNING!**

If you do not understand these directions, or if you have any doubts about the safety of the installation, please call a qualified technician. Check carefully to make sure there are no missing or defective parts. Improper installation may cause damage or serious injury. Do not use this product for any purpose that is not explicitly specified in this manual and do not exceed weight capacity. We cannot be liable for damage or injury caused by improper mounting, incorrect assembly, or inappropriate use.

**PACKAGE CONTENTS**

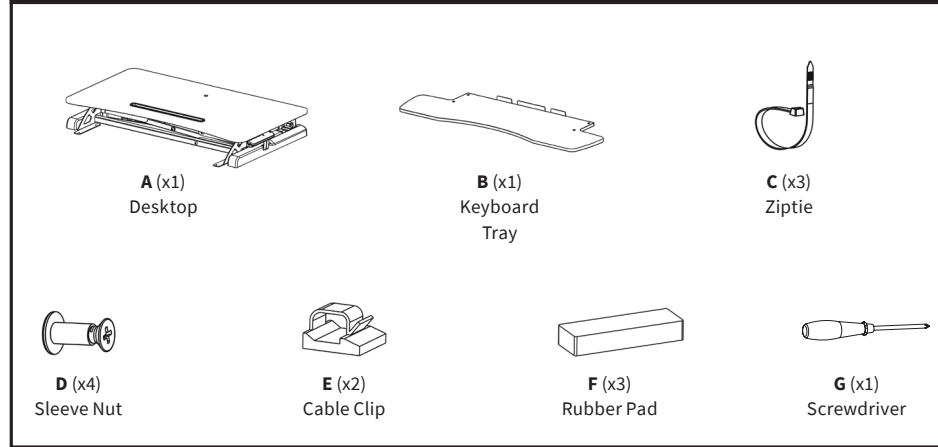

**TOOLS NEEDED**



**WARNING**  
**PINCH POINT**  
 DO NOT place hands on or near support bars. Moving parts can crush and cut. Pinch points are created during lifting and lowering the worksurface. Failure to follow these instructions may result in serious personal injury.

DO NOT EXCEED WEIGHT CAPACITY.  
 Failure to do so may result in serious injury.



**ASSEMBLY STEPS**

**STEP 1**

Separate parts (D) into (D1) and (D2).



**STEP 2**

Press (D1) into holes on top of keyboard tray (B). Apply pads (F) to underside of keyboard tray.

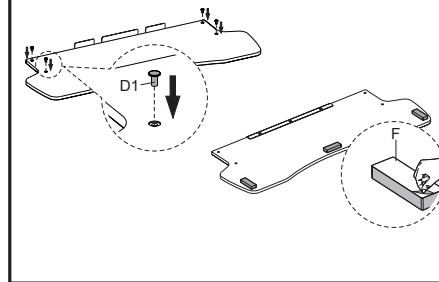

**STEP 3**

Cut the large plastic tie beneath desk (A). Raise the desk by squeezing the handles underneath the desk. Cut the four plastic ties on the base of the desk.

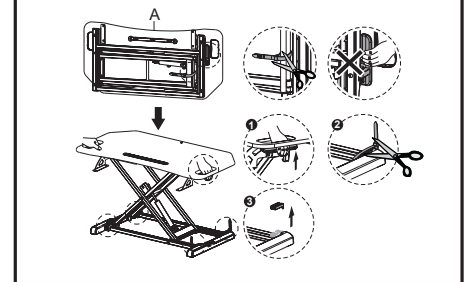

**STEP 4**

Place keyboard tray (B) on metal brackets on desk (A). Secure keyboard tray to brackets using screws (D2) and screwdriver (G).

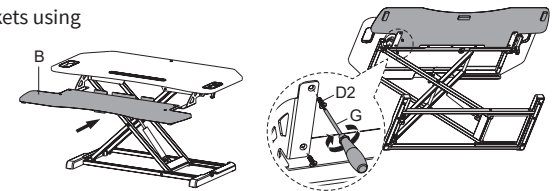

**STEP 5**

Apply cable clips (E) to underside of desk and manage cables using zipties (C).

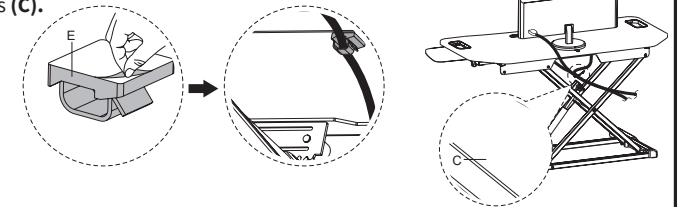

**CAUTION!**

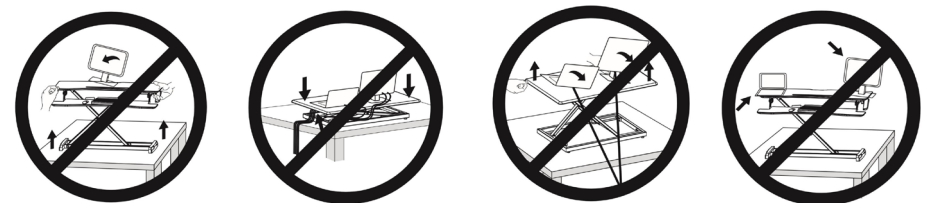

Keep monitor and laptop base fully on the desktop.

Follow the cable routing instructions to avoid the potential to pinch cables.

Leave enough slack in cable to allow for full range of vertical motion (15" / 38 cm).

Raise desktop slowly to keep items stable.

Failure to follow these instructions may result in property damage and/or personal injury.



Love your new VIVO setup and want to share?

Tag us in your photo! **@vivo\_us**

Last Updated: 9/18/2018



If any parts are received damaged or defective, please contact us. We are happy to replace parts to ensure you have a fully functioning product.



[help@vivo-us.com](mailto:help@vivo-us.com)



[www.vivo-us.com](http://www.vivo-us.com)



1-800-371-5654

For more VIVO products, check out our website at:  
[www.vivo-us.com](http://www.vivo-us.com).