



CAROLINA
GYM SUPPLY CORP.

The Industry Leader in Quality, Innovative Products for Gymnastics

877-G₄Y₉M₆-S₇T₈U₈F₃ | www.carolinagym.com

Carolina Rainbow P-Bar Multiblocks™

Page 21



Carolina Corral Mat

Page 33



Janssen-Fritsen Stand Alone Uneven Bars

Page 5



Carolina Kids Donut Halves

Page 34



Carolina Marshmallow Mat

Page 28

575 Dimmocks Mill Road Hillsborough, NC 27278
TOLL FREE: 877-G₄Y₉M₆-S₇T₈U₈F₃ | PHONE: 919-732-6999 | FAX: 919-732-1510

www.carolinagym.com | info@carolinagym.com

TABLE OF CONTENTS

Vault	2
Bars	5
Balance Beam	10
Dismount Mats.....	13
Floor Exercise	14
Pommel Horse.....	18
High Bar.....	19
Parallel Bars	20
P-Bar Blocks™	21
Rings.....	23
Panel Mats.....	25
Level 4 Vault Systems	26
Soft Landing Mats & Pits.....	27
Progression Shapes & Preschool Mats	31
Trampoline & Tumbling Products.....	38
Training Products.....	42
Policies & Ordering Information.....	43

ICONS



Carolina Gym
Exclusive



Customize It



Carolina
Kids



Coach's
Favorite

Since 1978, Carolina Gym Supply has been providing gyms all over the country and the world with matting and equipment of the best quality.

Our pride and joy are the amazing matting products that we sew right here at our warehouse in Hillsborough, NC. Not only can we supply all of your basic mats and equipment, we also love the challenge of creating custom mats for all of your unique needs. We hope you find all that you are looking for in our catalog, and if not, please give us a call and we will go above and beyond to get you exactly what you need!

VAULT

1 Janssen-Fritsen *Pegases* Vault Table

The FIG Vault Table from the leading manufacturer of competitive gymnastics equipment Janssen-Fritsen, an official equipment provider to Olympic Games and World Championships for over 40 years. Coaches and athletes both praise this vault table phenomenon for its ease of adjustment and superior rebound action. The *Pegases* features a new placement of the adjusting mechanism to the side of the pedestal. The unique table design raises itself by way of an internal nitrogen cylinder and an efficient locking handle.

Other design and function highlights: heavy-duty galvanized and epoxy-coated steel construction, four adjustable feet to compensate for floor surface irregularities, protective padding that completely surrounds the apparatus upright, tension system for safe use (FIG requirement), equal rebound over the entire surface, transport trolley included.



HEIGHT ADJUSTMENT: 105 to 135 cm (41.3" to 53.1")



2 Janssen-Fritsen Vault Boards *Iris Silver* & *Kreon Gold*

The 5-coil JF *Iris Silver* board is JF's FIG soft version board. This board has been redesigned and features improved dynamic qualities on the lower end of the springboard. The carbon fiber composite top improves flex over a larger area of the top without compromising strength and the spring placement has changed to move the springs more toward the center. The newly redesigned and curved bottom strut adds additional spring, and conical hardened tempered steel springs are the heart of what is called the JF Whisper Spring System (WSS), which makes for a quiet but incredibly quick and reactive spring board.

The 8-coil *Kreon Gold* board has all the features of the *Iris Silver*, but with eight springs. This is the JF FIG hard version springboard. The *Kreon Gold* springs are stiffer and gold in color. It is recommended for your upper level and elite girls as well as your powerful male gymnasts.

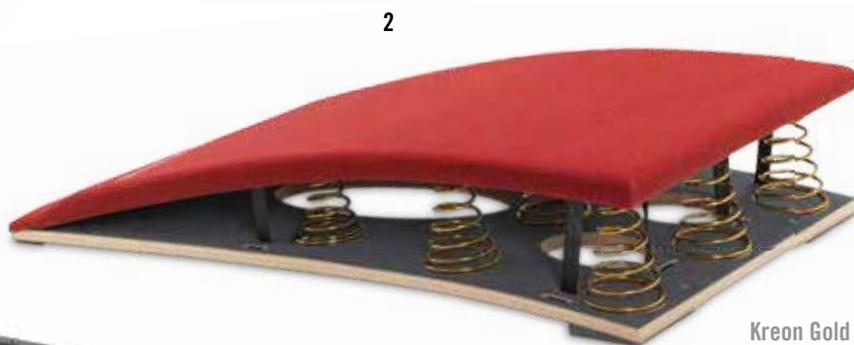

3 Vault Master

This mini tramp features a similar curvature to a springboard. Easily movable with wheels attached to the back of the frame. Used in competitions in accordance with USA Gymnastics rules.



3

4 Vault Runway

Dollamur carpet bonded foam offers good protection against shin splints. Other thicknesses available by special request. Also available in Flexi-Roll®.

DIMENSIONS: 3' X 84' X 1.375"



4

Vault Board Recovery Kit



ADDITIONAL ACCESSORIES

Vault Tape Measure

This superior grip no-sew tape measure is 100' long and features measuring tape bonded to hook fastener to adhere to a carpeted vault runway.

Vault Board Recovery Kit

Bound carpet, foam padding and adhesive to recover your vault board. Make your boards look and feel like new!



VAULT

5 Carolina Vault Table Trainer

Multi-purpose trainer system, ideal as a pit vault. Three sections break down for use in drills, or as stackable spotting blocks.



6 Carolina Vault Table Trainer – Men's Block

Add this additional 10 cm block to your Carolina Vault Table Trainer to raise it up to men's FIG height.



5 & 6



7 Carolina Respirator Vault Safety Zone

Why the Respirator? Because it breathes! Six large air holes, two at the front and two on each side, allow air to flow freely as board is punched for maximum spring. The large air holes are reinforced so that the mat will not collapse should an athlete miss the board and land on the zone. No more realigning the safety zone after each use. A webbing strap runs across the open end of the zone to attach one side to the other and ensures the zone will not "blow out" at the sides.



8 UPS-able Vault Safety Zone

Same design and features as the Respirator, but breaks down into three pieces for UPS shipping, saving you money! (not pictured)

9 Round Off Entry (ROE) Vault Mat

Our ROE mats are made in three varieties, all 1.5" thick. Easy on the wrists, all variations come with hook fastener to secure the mat to the carpet bonded runway with matching loop fabric to cover the hook when not in use.

- SUEDE ROE MAT: 100 cm X 120 cm, EVA polyethylene filler for energy return
- DENIM ROE MAT: 27.5" X 38.5", 6 lb. rebound filler for shock reduction (not pictured)
- DENIM ROE MAT: 100 cm X 120 cm, 6 lb. rebound filler for shock reduction (not pictured)



1 Janssen-Fritsen Stand Alone Uneven Bars

New and improved! Janssen-Fritsen has created Stand Alone Uneven Bars that can be used recreationally without cables. Features include an extremely stable base with additional retractable legs, high bar adjustable at chest height making it easy to reach for all athletes and coaches, fast and secure width adjustment with a fluted knob, quick release pin attachments for both rails, integrated safety indicator on adjustment knobs and built in transporter system. At home in a gymnastics training facility, but will also shine in multi-sport facilities, YMCAs or school settings where apparatus needs to be set up and broken down each day. These bars can also be used as a single bar trainer by removing low rail. Additionally, you can swap out the high bar for a men's rail. Cables are available for these bars which will enable them to be used for upper level or elite skills.



2 Janssen-Fritsen Stand Alone Insert Mat

The substantial base of the JF Stand Alone Bars requires a special insert mat to pad the base and attach to your existing dismount mats. Standard in 12 cm with hook and loop fastener on both 7.5' sides. Also available in 20 cm with any hook and loop configuration. (not pictured)



DIMENSIONS: 89.25" X 33" X 12 cm

3 Janssen-Fritsen US Bars

The bars we have been asking for... All the best qualities of the JF Stand Alone bars with a traditional base and standard cable layout. The ease of width and height adjustment will make these the "go to" bars for the US market from the oldest and largest gymnastics manufacturer in the world. These bars are an excellent value for all levels from beginner to elite gymnasts.

(not pictured)



4 Janssen-Fritsen *Mexico* Uneven Bars

Top competition uneven bars used in Beijing 2008 and Antwerp 2013. FIG certified. They offer the flex and feel that make them the choice for world class competitions.

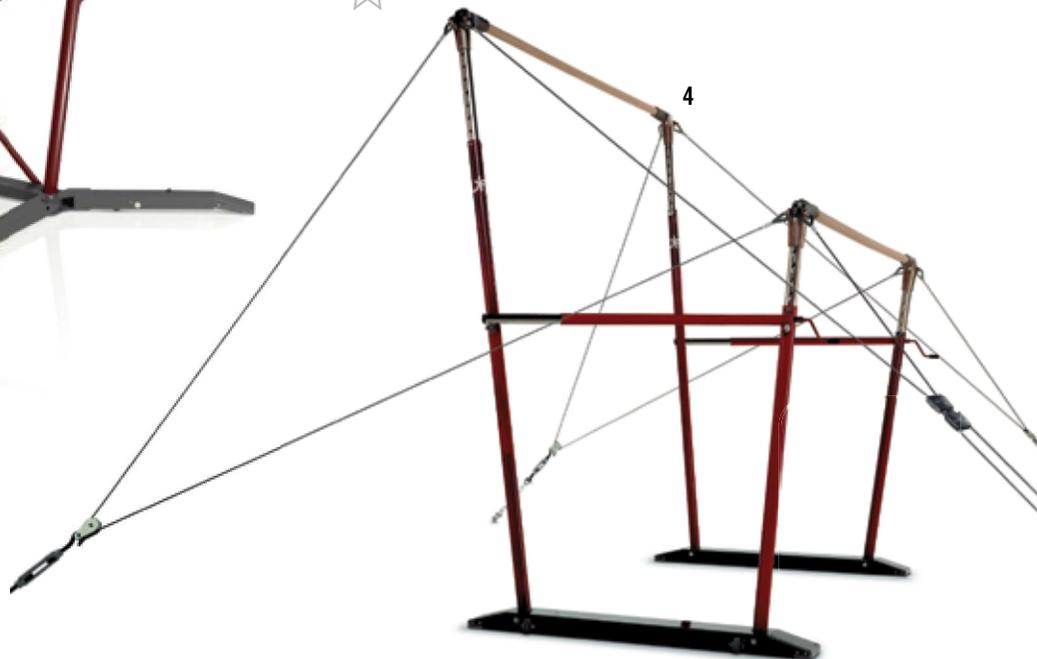

BARS

5 Janssen-Fritsen High Bar/Training Bar

The engineering and quality for which JF is known worldwide in a high bar/training bar. Rail rides on collars and easily clicks into place up and down the frame. The rail adjustment range is much higher than other training bars. The frame can accommodate a JF men's or ladies rail.



HEIGHT ADJUSTMENT: 80 to 290 cm (2.6' to 9.5')

6 8' Adjustable Bolt Down Single Training Bar

Sure to be used and enjoyed by all your athletes. Consider getting a men's and ladies rail for this frame and you have all the qualities of a high bar, training bar and strap bar in one frame. Stabilizing braces can be positioned for use over a T-shaped pit. Rails and straps sold separately.



FOOTPRINT: 4' X 10'
HEIGHT ADJUSTMENT: 6" to 8'

7 Spotting Platform

Designed to fit onto the 8' Bolt Down Single Bar Frame only. Adjusts easily in height up and down the upright by means of a pop pin and two tightening knobs. Platform is accessible from two built-in steps.

DIMENSIONS: 15" X 30"



6 & 7

8 & 9



8 5' Adjustable Bolt Down Training Bar

Perfect for everything from a handstand pirouette bar to a low training bar, this is a great setup for rec and team kids. Bolts solidly to the floor and is perfectly stable while saving valuable floor space in your gym. Rail sold separately.

HEIGHT ADJUSTMENT: 6" to 5'

9 3' Adjustable Bolt Down Single Bar/Trench Bar Frame

The name says it all... the bolt down style saves space. The height adjusts easily and is perfect for coaches to spot over a trench pit. Rail sold separately.

10 Adjustable Star Bar Frame

Imagine four training bar stations in only a 17.5' X 17.5' space! It's done with style and efficiency with an Adjustable Star Bar Frame when used with full-length rails. Bolt down design saves space and does not compromise stability. Each of the four rails can be adjusted independently. Able to accommodate any configuration of 6' or 8' rails. Rails and mats sold separately.

HEIGHT ADJUSTMENT: 6" to 5' (each rail)

11 Star Bar Mat System

A series of four mats, each with 4" hook and loop that allows them to interconnect continuously under all four rails of the star bar. Each mat has only the finest dismount mat foam within, 3.5" poly mat foam topped with 1.25" closed cell crosslink foam in an 18 oz double knife coated vinyl cover.



DID YOU KNOW?

The 8' Adjustable Bolt Down Bar is our best-selling bar, ever! Why? Because it is economical, it is stable and adaptable, it has a much smaller footprint than a cabled bar and it can be used on floor or over rectangular or T-shaped pits. It is easily used with both men's and women's rails and with the addition of quick release pins gives the coach the flexibility to go

between rails very quickly, easily and safely. The rails are adjustable from 6" all the way to 8'.

Did you know... You can use a Star Bar Frame with the center base and 2, 3 or 4 satellite bases. You can also use any combination of 6' and 8' to add bar stations in your available floor space. Mat systems can be made to fit with any rail configuration.

BARS

12 Carolina Trench Bar Pit System

Want to train really big bar skills? Carolina Gym Supply presents the ultimate in trench pits. Marshmallow Mat construction for the bottom of the pit gives 16" of protecting softness. Includes corner wedges and 8" soft mat lining for the end of the pit. Use Carpet bonded foam to line walls of pit before inserting this trench system.



13 High Bar Strap Bar

Steel Men's rail with Ladies AAI Style collars, use with quick release pins for a fast change on your training bar to a strap bar training station. Available with or without attached PVC and set of straps.

14 PVC Pipe & Set of Straps

The tried-and-true method to get your athletes doing giant swings with confidence. Set of 10 pairs of color coded straps and durable PVC pipe section.

15 Adjustable Leather Bar Straps & PVC

Leather wrap for the wrist and adjustable via hook and loop closure. A softer feel than traditional webbing straps. Your athletes will be swinging giants in comfort with one-pair-fits-all ease. PVC pipes included.



16 Space Savers™

An innovation from our friends at GYM-TRIX, Space Savers™ reduce the space needed by any cabled apparatus from 13' X 18' to 8.5' X 12.5'. Sold with or without pads. [\(not pictured\)](#)

17 Roller Bearing Cable Tighteners

The only cable tighteners to have on your cabled apparatus. Roller bearing action, precision welding and long rubber tipped turn-handles make the difference between this efficient and economic cable tighteners and all the others.

18 Carolina Handstand Pirouette Bar

1.5" diameter wood rail mounted on a tubular steel frame. Useful by itself and also excellent when used with a Swing Handstand Trainer. A wonderfully inexpensive and space-saving way to add a powerful training station to your gym.

AVAILABLE HEIGHTS: 6" or 12"

19 Swing Handstand Trainer

Solid steel construction for strength and stability. Bungee is adjustable to suit all ages and skill levels. For use with or without a handstand/pirouette bar.



20 Carolina Clear Hip Trainer

9" in diameter, attach this trainer to your bars to strengthen clear hip skills and prevent beginners from collapsing onto the rail. Also great to pad for baby giants.



21 Carolina Deluxe Bar Pad

30" long and made of a soft denim material. Great for Giengers, Jaegers, Tchkatchevs, straddle backs. Boys love them for stutzes, tosses, Healys, Diamidovs and other P-bars skills.



22 Quick Release Pins

Top quality, stainless steel pin with button handle provides security and speed for you to change out rails on your training stations. Sold in pairs only.



23 Janssen-Fritsen Trainer Console

The Janssen-Fritsen Trainer Console gives coaches the large stable surface they need to spot their athletes and gives athletes easy access to any apparatus. A nitrogen cylinder tips the platform up out of the way when not in use. Trainer Console is anchored independent of the apparatus and will work with any brand apparatus.



PLATFORM DIMENSIONS: 50 cm X 120 cm
(19.75" X 47.25")

HEIGHT ADJUSTMENT: 131 to 191 cm tall in 10 cm
increments (51.5" to 75.25" in 4" increments)

24 Carolina Mounting Block

Think of it as a springboard made of foam. Much lighter and more maneuverable, less expensive and nonabrasive to vinyl surfaces. Most commonly used for bar and beam mounts, we are sure you will use it often!
(see balance beam section #8, page 11)

17



18



19

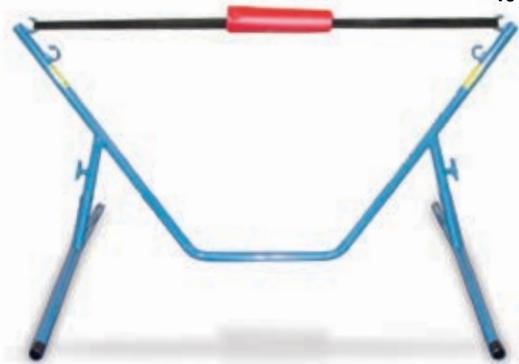

20



23



21



22



BALANCE BEAM

1 Janssen-Fritsen Nitro-Assist Adjustable Competition Beam

Unsurpassed combination of design features and attractive pricing make this our best-selling beam ever! An engineering marvel from Janssen-Fritsen, this is a very adjustable, truly soft top, competition beam. Your coaches will love the way it adjusts easily with the use of a nitrogen cylinder. Simply release the pull ring with gentle thumb pressure downward and with light pressure from the other hand, this beam slides easily to adjust height. Legs stay put as beam adjusts—no need to constantly realign your beam mats.



HEIGHT ADJUSTMENT: 50 cm to 130 cm (19.7" to 51.2")

2 Janssen-Fritsen Top Competition Beam *Lausanne*

This is the beam used in Beijing 2008 and Antwerp 2013. FIG approved, elastic padding with Janssen-Fritsen's hygroscopic covering and shock absorption system. A must for elite gyms! You WILL see this beam at international competitions.



HEIGHT ADJUSTMENT: 65 cm to 125 cm (25.5" to 49.2")

3 Janssen-Fritsen 5m Soft Top Low Beam

This is the same toe-friendly soft top beam as the Nitro-Assist beam but on low legs (working surface 12" off the ground). It will reduce fear and allows for more repetitions during practice. Also a good option for a full-length home beam. (not pictured)



4 Carolina Balance Beam Upright Pads

Let Carolina Gym Supply make the best-fitting, safety-enhancing upright pads for any beam in your gym. Specify the manufacturer of your beam when ordering. Shown here are upright pads for the JF Nitro-Assist Beam.



5 Carolina Balance Beam Foot Pads

Our standard beam foot pads are more substantial than other manufacturers. Pads are available in two thickness options, with or without fastener, to attach to your beam landing mats. Specify thickness and width of your dismount mat when ordering.



AVAILABLE THICKNESS: 12 cm X 20 cm



6 Carolina Balance Beam Training Pad

Covers half the length of a 16'5" competition beam. This pad makes the working surface of the beam 6.5" wide and provides padding to the sides of the beam as well. Training pad secures to the beam via webbing straps and side release buckles that fasten securely under the beam and can be tightened so the pad will not shift. A single pad comes with a hook flap that can join to a second training pad to make a full length wide beam. Made standard with red vinyl, competition synthetic suede also available.



7 Carolina Suede Beam Sting Pad

This popular training aid maintains competition feel and width of the beam, and the 6' length puts the extra 5/8" of softness right where the athlete needs it. Webbing straps and side release buckles allow the pad to hug the beam so tightly it will absolutely not shift. Most commonly sold in the 6' length, we also make this beam pad full length. Great for training purposes and also terrific for giving new life to an old beam without recovering it.



8 Carolina Mounting Block

Think of it as a springboard made of foam. Much lighter and more maneuverable, less expensive and nonabrasive to vinyl surfaces. Most commonly used for bar and beam mounts, we are sure you will use it often!



BALANCE BEAM

9 Carolina Balance Beam Recovery Kit

Contains all the materials you will need to recover a 16'5" beam: new foam padding for the top of the beam, synthetic suede material, two cans of spray adhesive and easy-to-follow directions. Please specify whether you have a wood or aluminum core beam when ordering.

10 Practice Beams

Available in carpet or suede. These beams are always popular, affordable choices for gym and home use. Beam tops and bases sold separately.

AVAILABLE LENGTHS: 8', 12' and 16'5"

11 Beam Bases

Beam bases come in sizes to make the working surface of your beam 10", 12" or 20" off the floor.



AVAILABLE HEIGHTS: 10", 12" and 20"

12 8' Practice Beam

Available with a carpeted or suede padded surface. This beam has a working surface 7" off the ground and includes bases. A good choice for gyms, home use or mobile programs. Ships UPS.



13 Rollable Rubber Beam

Available in three lengths. Red, white and blue heavy rubber lies nicely on the floor with no rolling. Beam is 1" high, 4" wide top, beveled to a 6" wide base. Easily portable, this beam is always popular with preschools and mobile programs. (not pictured)



AVAILABLE LENGTHS: 9', 12' and 16'

14 Carolina Colorful Vinyl Beams

Our simplest product is also our most versatile. A great way to add color and creativity to all your classes. Beams are 4" wide. Available with hook fastener to attach to carpet or non-skid backing for use on matting or hardwood/tile floors. Sold in sets of 7.



AVAILABLE LENGTHS: 4' and 8'

10, 11 & 12



14



DISMOUNT MATS

1 Carolina Dismount Mats

Quality dismount mats are crucial to every program. Standard Carolina construction means extra touches, such as stress seams being sewn as many as three times and seams thoughtfully placed to be off center and out of the highest traffic zones. All our dismount mats have handles on all sides. We use a firm urethane foam and crosslink foam top to give the forgiving feel and good footing needed for stuck landings and maximum longevity. We also use zigzag stitched 4" hook and loop fastener to connect our discount mats. Hook and loop available in any configuration.

AVAILABLE IN: 12 cm and 20 cm



ADDITIONAL SIZES

Carolina Dismount Mats

Standard sizes listed, custom sizes always available.
Mats will be made in blue if another color is not specified.

- 6' X 12' X 12 cm - NO FOLD
- 6' X 12' X 12 cm - TWO FOLD
- 6' X 15'6" X 12 cm - NO FOLD
- 6' X 15'6" X 12 cm - TWO FOLD

- 7'6" X 12' X 12 cm - NO FOLD
- 7'6" X 12' X 12 cm - TWO FOLD
- 7'6" X 15'6" X 12 cm - TWO FOLD
- 7'6" X 15'6" X 20 cm - TWO FOLD
- 8' X 12' X 12 cm - NO FOLD
- 8' X 12' X 12 cm - TWO FOLD
- 8' X 12' X 20 cm - TWO FOLD
- 8' X 15'6" X 12 cm - NO FOLD
- 8' X 15'6" X 12 cm - TWO FOLD
- 8' X 15'6" X 20 cm - TWO FOLD
- 8' X 18' X 12 cm - ASYMMETRICAL TWO FOLD
- 8' X 18' X 20 cm - ASYMMETRICAL TWO FOLD

FLOOR EXERCISE

1 Carolina Spring Floors

Our years of experience have led us to what we believe is the finest spring floor construction in existence.

Whenever customers ask us to recommend a spring surface for floor exercise or cheerleading, we specify Baltic birch plywood. Whether mounted on Palmer Springs or our Carolina Foam Blocks, the strength and uniformity of the 5' X 5' X 9 mm Baltic birch gives the best punch and highest air without breakage.

Floors are constructed in two layers. Hook and loop fastener goes between layers to provide a movable and secure yet flexible connection for optimal energy return from the floor.

Palmer Power Springs are the best choice for the successful competitive program seeking the highest energy rebound for top level tumblers. The patented spring cap design lends incredible stability to springs.

Carolina Foam Blocks are constructed of high energy mini-cell foam. The foam block floors provide a quieter, more forgiving bounce for the recreational program at an economical price. The wider 4" X 4" block is more stable than other 3" X 3" foam cubes since ours provide 16 square inches of foam contact versus just 9 square inches.

Save money by purchasing a kit and build your own floor (a good weekend project), or purchase a ready-to-assemble floor.

Spring floors are available as standard 42' X 42' for gymnastics, 42' X 54' for competition stage cheerleading, or any custom size that you require for your gym, studio, tumbling strip or traveling floor.

Top your floor exercise area with crosslink foam and Carolina Super-Fine or Elite Bordered Carpet for the ultimate in good looks, durability and performance, or you can opt for the economy of Dollamur Carpet Bonded Foam rolls, in standard or Flexi-Roll® configurations.

Carolina floor exercise systems can be finished with simple vinyl skirts, unfinished foam borders or vinyl covered foam in your choice of shapes and colors. Call for details.



BALTIC BIRCH DIMENSIONS: 5' X 5' X 9 mm
CAROLINA FOAM BLOCK DIMENSIONS: 4" X 4" X 4.5"
AVAILABLE SIZES:
Gymnastics: 42' X 42'
Competition Cheerleading: 42' X 54'
Custom Sizes Available



1



4a



4b



2 Carolina Super-Fine Carpet

The carpet is bound on all edges and hook and loop is sewn to each section. This made-to-last carpet is available in several colors. Please call for colors and to receive samples. Custom sizes are available. Please call and we'll help you design a carpet that will look great and serve your gym well! (not pictured)



CARPET DIMENSIONS: 45' X 45', (three) 15' sections

3 Carolina Elite Bordered Carpet

A true standout in design and function, this carpet has all the features and quality of our Super Fine Carpet and is available in a standard dark blue with white border or many other striking combinations. Nothing will dress up your gym and perform like a Carolina Elite Bordered Carpet!



PERFORMANCE AREA: 12 m square (29' 4½")
 BORDER DIMENSIONS: 91 cm (3')
 COMPLETE CARPET DIMENSIONS: 13.8 m square (45' 4½")

4 Carolina Floor Border

Combine style and safety with one of our Carolina Floor Borders to complement your spring floor. When ordering, specify spring floor height including foam, length of bordering required including the number of corners, style of border and vinyl covering color if desired (uncovered foam borders may be placed under standard carpet margins). All Carolina Floor Borders have 4" flaps with hook fastener to attach to Carpet Bonded Foam. Custom sizes available!



4a Deluxe Floor Border: 6" high comes 12" out level with floor then slopes to end at ½". Total distance away from the floor is 27".

4b Standard Floor Border: sloped 6" to ½" and comes 12" away from the floor.

5 Carolina Floor Skirt

The most cost-effective way to hide or neaten the edge of your floor, our Carolina Floor Skirt is a simple drop skirt made in your choice of vinyl color with 2" hook fastener sewn to the top to attach to your carpet. We can also make skirts for Tumbler Traks and Rod Floors! (not pictured)



FLOOR EXERCISE

6 Carolina Corner Mats

Need a little extra padding on those diagonals? Use our custom corner mats to give your athletes more confidence when practicing those powerful tumbling passes on floor. Made custom to your specifications, these mats will increase the “landing” area of your diagonals, so even if it’s not perfect the first time, your athlete is safe from stepping off the edge of the floor.

(not pictured)



7 Carpet Bonded Foam

Heavy duty needle punch carpet flame-laminated to crosslink polyethylene foam, this is the preferred surface for cheerleading. Great for general purpose matting, pit edging and floor exercise areas. Available in traditional style or Flexi-Roll®. Standard in blue, also available in red, gray, black or purple for an additional charge.

AVAILABLE THICKNESS: 1.375" and 2"

8 Vinyl Carrying Cover

Keep your Carpet Bonded Foam tucked away safely in these nifty carrying covers when not in use! Handles on the ends allow for two people to easily carry them in and out of storage. Customize them in any of our vinyl colors at no additional charge.



Available Colors



9 Crosslink Polyethylene Foam

Crosslinking the molecular structure gives this product greater performance and longer life than non-crosslink counterparts. Use under carpeting for basic padding, pit edging or floor exercise areas.

AVAILABLE THICKNESS: 1.25" and 2"

10 2" EVA Modified Crosslink Foam

Bring your floor up to Elite level with this “cream of the crop” crosslink foam. The creamy structure of the EVA Modified Crosslink provides extra energy return for tumbling passes. A noticeable step above regular cross-linked foams. (not pictured)



11 Carolina Martial Arts Flooring

Custom tarps secured over 1.25" or 2" crosslink foam provide an easy to care for, attractive and long lasting surface for your club or dojo. Call for pricing. A favorite of our friends at many Choe's HapKiDo locations! (not pictured)



12 Carolina Spring Floors for Martial Arts

Get the latest in martial arts performance flooring! Foam block floor configurations provide the ultimate in fatigue reduction with injury-reducing technology. Any size available. Call to have us help you design the best fit for your program. (not pictured)



13 Carolina Dance Floor

The Carolina Dance Floor is the economical, high performance answer to your dance floor conundrum. Polyethylene foam shock absorbers mounted to our Baltic Birch plywood provide the stability and shock reduction needed by top performers. Shock absorbers can be mounted permanently or can be made removable for portable floors. (not pictured)



14 Carolina Pole Pads

Whether you've got round poles, square poles or I-beams supporting your gym ceiling, let Carolina Gym Supply keep your athletes safe with custom made pole pads. Available in several styles and in any size. Call with your specifications.



8



9



14

POMMEL HORSE

1 Janssen-Fritsen *Madrid* Competition Pommel Horse

FIG approved. The padded leather top has the cushioned support and nonslip feel that lends itself to a lot of repetition and high quality routines. The aluminum tube pommels are covered with a hygroscopic anti-slip rubber compound for superior grip. Comes with built-in transport system.



HEIGHT ADJUSTMENT: 95 cm to 125 cm in 5 cm increments

2 Janssen-Fritsen Junior Pommel Horse

The apparatus that deserves to be in every boys' gym in the country. Being 90% the size of a regulation size pommel horse, junior boys are able to perform increasingly more difficult routines that demand a high quality horse that fits the athlete. Picture swinging circles while doing an iron cross. This is what it's like asking talented junior boys to swing circles and upper level skills on a full size pommel horse. It is amazing to see how much faster progress comes when the apparatus fits. Put your boys on the fast track today with the JF Junior Pommel Horse. (not pictured)



3 Carolina Pommel Horse Platform Mat

Our innovative design delivers a beautiful, functional platform mat at a fraction of the cost of traditionally designed platform mats. There is no vinyl mat bottom, eliminating all the intricate stitching and labor to make the cover fit the base. The cover fits like a fitted bed sheet with straps holding it together. Until you lift the mat and look underneath, you can't tell there is no bottom! Another Carolina Gym Supply innovation, perfect for your gym's needs.



4 Ultra Dome™

The premier pommel horse training product from our good friends at GYM-TRIX. Bucket-style base is smooth and stable, and the domed top is nicely covered and padded to be easy on the wrists. To really accentuate and train that big stretch needed for pommel horse success, place the Ultra Dome™ top directly on the floor and let those circles fly!



3

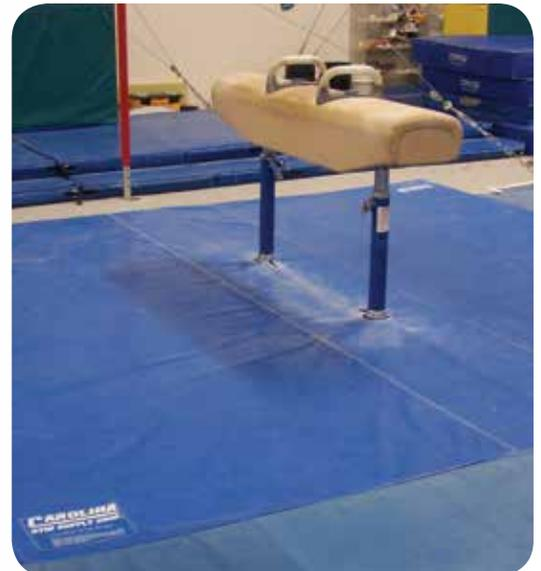

5 Pommel Top Ultra Dome™

Once the athlete can regularly do 10 circles in a row on the smooth top, they are ready to begin training on the Pommel Top Ultra Dome. The pommel top attaches to the same base as the smooth top Ultra Dome™ and includes one pair of pommels and a single, extra-long pommel that is very useful for training behind-the-back work. The pommel top has slits that allow you to adjust the distance between the pommels.



HIGH BAR

1 Janssen-Fritsen *Munich* Competition Horizontal Bar

This is the world class bar used in Beijing in 2008 and Antwerp 2013. Secured by a dual cable tension system. Designed to limit bar vibrations on big release moves. If you have athletes that really crank, this is the bar for you!



HEIGHT ADJUSTMENT: 275 cm to 310 cm
(approximately 9' to 10')

ADDITIONAL EQUIPMENT

page 6

JF High Bar/Training Bar
8' Adjustable Bolt Down Bar

page 8

High Bar Strap Bar
PVC Pipe & Straps

page 9

Quick Release Pins



PARALLEL BARS

1 Janssen-Fritsen *Pallas* Parallel Bars

JF's engineers have created the ultimate in stable competition parallel bars. The conic uprights and redesigned base ensure stability for the giant style swings being performed frontally and laterally in modern elite routines at the new FIG height. The precision engineered clamp lever lock heads and nickel-plated sliding tubes make height and width adjustment quick and easy. The rails are finely laminated wood with three fiberglass inserts. The resulting construction gives superior flex and the grip athletes need. Your upper level and elite boys will prefer these bars to all others.



WIDTH ADJUSTMENT: 41 cm to 61 cm
HEIGHT ADJUSTMENT: 160 cm to 210 cm in
5 cm increments

2 Carolina Parallel Bar Insert Mat

A very efficient and inexpensive way to pad the inside base of your parallel bars. Ideal for recreational programs and programs that can't afford the cost and space needed for a full size platform mat. Use this mat, then pull up regular dismount mats to the sides of the bars and your parallel bars are matted. Specify brand of parallel bars when ordering. (not pictured)



3 Carolina Style Economy Parallel Platform Mat

Our platform mat is designed for the cost conscious club owner. The insert mat and the end mats are traditional construction. The side mats have no bottom, eliminating the intricate stitching, bottom fabric and much of the construction cost. The cover construction of the side pieces is like a fitted bed sheet. Straps are used under the cover to keep the cover tight around the foam.



4 Carolina Competition Platform Mat

The ultimate in training and competition safety for today's tough athletes performing big tricks on parallel bars. Premium 20 cm dismount mat foam is fully encased in our toughest vinyl and used in this modular matting system. Fully customizable to meet your training and competition needs. All sections attach with 4" wide hook and loop. Specify brand of parallel bars when ordering.



4



P-BAR BLOCKS™



Innovative design features allow for versatility and create a multi-functional product that can be used many ways in men's and women's gymnastics and cheerleading!



1 Carolina Rainbow P-Bar Blocks™

US PATENT #4968025

The ORIGINAL patented Rainbow P-Bar Blocks™ are one of the most useful and innovative products you can have in your gym. Developed originally by Carolina Gym Supply's founder Ben Edkins as a training aid for boys learning above-bar swing skills, they have found their niche in every part of the gym school curriculum. Each full-sized block weighs less than 50 lbs., making it the lightest, most stable portable spotting block available.



DIMENSIONS: 27" X 51" X 39" with attached 1.5" high foam rail making the swinging height 40.5"

2 Carolina Rainbow P-Bar Multiblocks™

US PATENT #4968025

Multiblocks™ are covered under the same patent as the regular P-Bar Blocks™. The hook fastener on removable foam rails adds additional versatility. Multiblocks™ can be stacked on top of each other and are compatible with other P-Bar Block™ products.



DIMENSIONS: 27" X 51" X 39" with 1.5" removable rail

P-BAR BLOCKS™

CAROLINA GYM INSIGHT

3 Carolina Rainbow P-Bar Half Blocks™

US PATENT #4968025

Identical in composition, design and outside dimension as our Original P-Bar Blocks™ and Multiblocks™, these blocks are half as tall at 19.5" and weigh less than 25 lbs. The hook and loop fastener is completely compatible with other P-Bar™ products, giving you a multitude of options of height for spotting blocks, training shapes, plyometric boxes, beam table, spotting stations and trench bars... Order as many as you need! P-Bar Half Blocks™ are sold individually, in pairs, sets of four or mixed sets comprised of (1) full-size Multiblock™ and (2) Half Blocks™. Our extremely versatile P-bar products will solve all your spotting dilemmas and double as awesome training shapes all over your gym!



DIMENSIONS: 27" X 51" X 19.5"

When Don Peters, former girls' national coach, then at SCAT's Gymnastics, ordered his second set of blocks, we asked him why he needed the extra set. He said he had been taking them from the boys' side of the gym (annoying the boys' coaches) and using them at the end of beam like a beam table, for teaching round-off layout step-out mounts. We realized then that perhaps we had misnamed the product since most gym owners are hesitant to spend money on something that only the boys would use. The super lightweight stiff patented construction makes them ideal spotting blocks as well as preschool blocks. Girls swing on them to learn cast handstand on unevens. Dwight Normile of "International Gymnast Magazine" said he uses them on their ends close together to teach iron crosses. Cheerleaders use them as a practice base when one of their girls is out sick. With all the members of our P-Bar Blocks™ family now available, how many ways can you think of to use this awesome product?



Hook Flap & Loop Fastener



Removable Rails



3

See how versatile our P-Blocks™ are when used separately or together -->



1 Janssen-Fritsen *Atlas* Ring Tower

Used in Beijing 2008 and Antwerp 2013. Improved shock absorption reduces shoulder strain. This ring frame has quickly become the favorite of elite athletes for its superior flex.



HEIGHT ADJUSTMENT: 275 cm to 310 cm in 5 cm increments (108.2" to 122")

2 Janssen-Fritsen Ceiling Hung Rings

The Janssen-Fritsen Ceiling Hung Rings deliver the exact same shock absorbing flex of the *Atlas* Ring Tower. This is because the internal mechanism is exactly the same in both apparatus. Want that Olympic feel without taking up so much space, not to mention so much money? This is the ring set for you!



3 Beam Clamps

We offer a wide variety of beam and pipe clamps for mounting rings, ropes, nets and spotting rigs to virtually any ceiling structure. Call for more info!

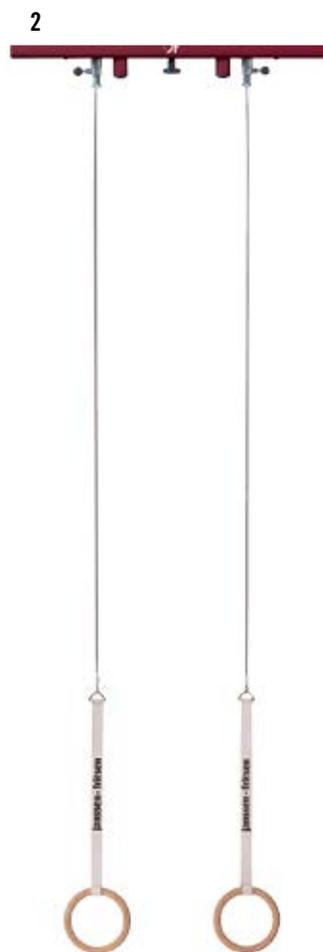

RINGS

4 Hardwood Rings

Top quality competition rings. Meets FIG specs.

DIMENSIONS: 7-3/32" inside diameter with 1-1/8" grip size

5 Junior Rings

Use with our Ring Extension Straps to hang from the low bar or your existing rings. These smaller rings are perfect for your little athletes!



DIMENSIONS: Approximate diameter 7"

6 Official Length Ring Straps

Includes buckles and delta quick links.

LENGTH ADJUSTMENT: 27" strap is adjustable 18" up to 4" down

7 Deluxe Ceiling Hung Rings

Includes beam clamps, springs swivels, custom length cables, straps and competition wood rings. Spring Ring Swivels reduce the stress on shoulders and back when doing dislocate moves. Specify ceiling height and desired ring height, along with I-beam specs when ordering.



4



5



SPRING SWIVELS



6

7

ADDITIONAL ACCESSORIES

Extension Ring Straps

Adjustable straps lower rings up to 3 ft.

Spring Swivels

Spring-loaded replacement swivel reduces shoulder and back strain. Sold in pairs.

PANEL MATS

1 Carolina Panel Mats

The basic building block of any tumbling, gymnastics, cheer, acro, martial arts or exercise class. They are available in six standard sizes and two styles. V2 means the mat has hook and loop fastener along the two shorter sides of the mat so they can be put together to form a strip. V4 means they have hook and loop on all four sides so they can be attached side by side as well as end to end.

Panel mats are not only great tumbling surfaces, they can also be hung on the walls for storage or protection in areas of potential wall impact by your athletes. Folded stacked panel mats make great spotting blocks or "boosters" for kids learning new skills or needing assistance getting over a tumbling shape such as a Handspring Pro or Octagon.

Panel mats are our number one at-home mat. They are easily portable and are practical for all kinds of home practice and exercising. The surface is extremely durable and easy to clean. All panel mats fold neatly for storage and easy transport.

Our standard panel mat is filled with 1.25" closed cell crosslink foam. The standard panel mat is a great choice for most gyms and works well as a home mat.

Our 2" panel mat is filled with the same 1.25" crosslink foam with .75" of firm urethane foam glued to the underside of each piece. The 2" panel mat has more give but still offers firm footing. Consider the 2" panel mat when you want a little more forgiveness and springiness.



AVAILABLE SIZES:

4' X 6'	4' X 12'
4' X 8'	5' X 10'
4' X 10'	6' X 12'



2 Carolina Rocket Mat

Think of it as a folding spring floor. This mat is similar in construction to a panel mat. The secret weapon of this mat is the 3" thick EVA modified foam filler. The super springy foam offers action approaching spring floor quality. This is the perfect mat for clubs and schools that have a tumbling program but need a small or portable spring floor. Each mat has hook and loop fastener along the two 6' ends and can be made with hook and loop fastener on all four sides.

(not pictured)



DIMENSIONS: 6' wide with four 4' panels (total length of 16')

3 Rock Wall Mats

Rock climbing and bouldering areas can create some real matting challenges. We like to think we have a grasp on the obstacles you might face, as we have helped several climbing gyms from California to New York find the best matting solutions for their climbing areas. We can help you figure out the best fit for your space. Give us a call to discuss your particular rock wall matting needs! (not pictured)



LEVEL 4 VAULT SYSTEMS

1 Carolina Level 4 Vault Mat Systems

The entire first 32" of the mat are a contrasting color to the rest of the mat. The whole system connects together easily with 4" hook and loop. One person can quickly add and peel the 8-inchers from the front of the stack making your meet or training go much quicker. All of our L4 Mats have a 4" hook flap at the leading edge, so that when folded back on top of the mat, it catches the 4" loop we have sewn to the bottom of the L4 mats. The 8" mats have hook and loop fastener on leading 5' edge so that when they are not being used for Level 4 vault, you can stack them securely or fasten them end-to-end for other training needs.



Standard Stack The traditional configuration of our Level 4 Vault Mat System. You can't go wrong!

DIMENSIONS: (1) 5' X 10' X 32" (2) 5' X 10' X 8"

Standard Stack PLUS This system gives you the versatility and usefulness of (2) 5' X 10" Marshmallow Mats in a very easily portable size. You can also attach

end to end to create a soft and springy tumbling strip. Your coaches will fight over these mats when they are not being used for L4 vault! **(not pictured)**

DIMENSIONS: (2) 5' X 10' X 16" Marshmallow Mats (2) 5' X 10' X 8"

Deluxe Stack When not in use for Level 4 these modular pieces can easily be moved all over your gym to create a pit feel in only 16". The extra width allows you to do Tsuk timers, handspring front timers, Comaneci timers, Cuervo timers, Yurchenko timers and other drills for which 5' width is just too narrow. When you are done using them for timers as a 32" pit, fasten them together end to end, connect them and the 8-inchers end to end. Now you have 30' of super forgiving matting for teaching basic tumbling. Because of the unique formulation of the top foam, it actually springs back, allowing little hot shots to do up to double full and bigger kids up to a tuck, just by tumbling across the Marshmallow Mats. A great choice if you train Level 4 and need other 7.5' wide soft mats around your gym!

DIMENSIONS: (2) 7.5' X 10' X 16" Marshmallow Mats (2) 5' X 10' X 8"



STANDARD STACK



DELUXE STACK

SOFT LANDING MATS & PITS

1 Carolina 8" Mats

This is the go-to mat for a soft, low-profile skill cushion. The medium-firm foam cushions without bottoming out. Our most popular 8" mat is the 5' X 10'. Made standard with a solid top, available with mesh top upon request. Check out our 5' X 10' X 8" mats specifically designed for use in the Level 4 Vault System. Available in a no fold or two fold version.



AVAILABLE SIZES: 4' X 6' X 8", 4' X 8' X 8", 5' X 10' X 8", 6' X 12' X 8" (2 Fold), 8' X 12' X 8" (2 Fold)



1

2 Carolina 12" Soft Landing Mats

All the design features and quality foam that Carolina Gym Supply is known for in a 12" soft landing mat. Available in folding or non-folding. If you are looking for a super soft mat in a low profile, also please see our 16" thick Marshmallow Mats. **(not pictured)**



AVAILABLE SIZES: 6' X 12', 8' X 12'



3 Carolina Mod Mats

Think MODULAR. Mod mats have 4" hook and loop fastener along the long sides that make them extremely versatile and easily to move around your gym. Coaches can easily transform the size of the mat to suit training goals.

AVAILABLE SIZES: 4' X 6' X 8", 4' X 8' X 8"



3



SOFT LANDING MATS & PITS

4 Carolina Marshmallow Mat

A Carolina Gym Supply Original. The mat that allows you to put a pit anywhere in your gym, any time you want. Mike Rizzuto of Nittany Gymnastics gave us the original idea to create this unique mat. Our goal was to design a mat that was super soft, durable and easy to carry around the gym. To that end, we use an intricate lattice to keep from bottoming out and very dense top foam that is chemically formulated to be very soft. It has that resi feel but in only 16". Original size makes them usable as an individual mat and stackable for use as a 32" resi for drills. Use the 4" hook and loop fasteners to connect. Use under beam, at the end of beam or behind a tumble tramp. The mat slides under the frame and does not interfere with the bounce so there is no "black hole" where the tumble tramp ends and the mat begins. Use under unevens and your smaller kids will be able to swing giants with 16" under them. For larger gymnasts, raise your bar bases up on blocks, extend the cables with chain and you have pit bars. At the end of your 7" high spring floor you can tumble into the Marshmallow Mat and it's like tumbling into a 9" mat that feels like a resi. Why limit yourself with an above ground 32" pit that is good for only a few drills and requires your entire team to move around? Get two Marshmallow Mats and you have a versatile soft matting system in an easily portable form that you will move all over your gym. Check out the Deluxe Level 4 Marshmallow Mats that double as a Level 4 base!



DIMENSIONS: 7.5' X 8' X 16", 7.5' X 10' X 16", 5' X 10' X 16"



4



5 Carolina In-Ground Resi Pits

We take great pride in doing your in-ground resi pits. Our unique design offers economy, longevity and performance to your pit system. We use an intricate foam lattice of specific densities and compressions. Only the top slab is covered in vinyl and mesh fabric. The top and bottom are reversible giving double life to the cover. Since the top foam is not glued to the lattice, it can be easily replaced if it does wear out. Modular sections are connected using 6" inch hook and loop, top and bottom. Care in measuring and attention to detail assure a beautiful, functional fit.



6 Carolina Custom Pit Edging

From do-it-yourself upholstering with crosslink and vinyl or carpet bonded foam to premade pieces that can be screwed or fastened with hook and loop fastener, there are as many ways to edge a pit as there are pits that need edging. Things to consider are the type of hole (i.e. loose foam, in-ground resi, in-ground tramp or tumble tramp) and what activities are happening around the space. Use our experienced staff to help you find the best fit for your pit and pocketbook.



5



6



7 Carolina 6" X 6" X 6" CAL 117 FR Pit Cubes

Combustion modified foam cubes to fill or fluff your pit. We sell only CAL 117 FR foam cubes of optimum density and compression. Blue, red, charcoal, dark charcoal, lime and yellow available.



8 Carolina Frame, Springs & Bed for Loose Foam Pits

More economical than filling a pit with all foam, and the trampoline bottom fluffs the pit cubes with each use! Many sizes and configurations are possible. Wavy wire frame is easily self-installed on site (concrete anchors available but not included). The tramp bed is made to fit your pit and has flaps that cover the spring area to keep cubes from falling through. Smaller pits (up to 10' span) are standardly dug at 6' and the tramp bottom suspended at the 3' mark. Larger pits (up to 20' span) are typically 8' deep with the tramp bed suspended at the 3' mark. Every gym has its own unique situation and there are many factors to consider. Please call us and we will be happy to help you through the process of ordering and installing your own tramp bottom loose foam pit!

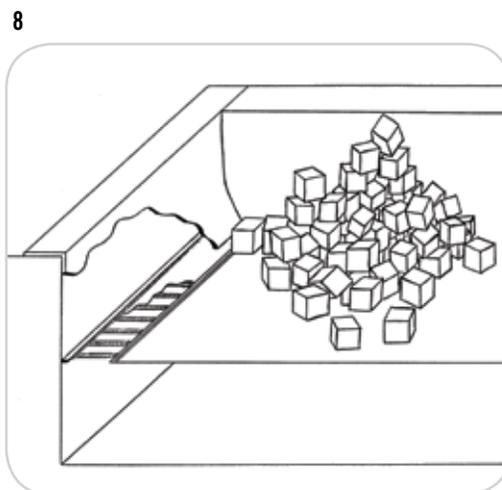

9 Carolina 55" X 77" X 1.5" Denim Sting Mat

A long time Carolina Gym Supply favorite! This soft denim cover is filled with superior quality 1.5" thick 6 lbs. rebound foam. This combination gives the mat the perfect weight to lie flat on floor or drape nicely over beam or bars. Comes with 2" seat belt webbing strap to roll.



SOFT LANDING MATS & PITS

10 Carolina 4' X 8' X 4" Denim Mat

Put a little extra softness right where it is needed with this denim covered throw mat. A favorite of coaches and athletes. The denim cover is durable, but has a soft, friendly feel. Mat has handles on each 4' side for easy placement and removal. 2" wide seat belt webbing strap at one end secures mat when rolled for storage or transport. Strap also allows coach to pull the mat off the floor without going onto the competition area. Cover unzips easily for laundering. Thanks to Milan Stanovich for the inspiration to create this long time favorite and super useful sting mat! **(not pictured)**

DIMENSIONS: 4' X 8' X 4"

11 Carolina Vinyl/Mesh Top Throw Mat

Sturdy yet forgiving throw mats are designed for tossing under floor ex landings. This mat is also used behind vault, under a training bar or wherever a little extra protection and softness is needed. Mesh top is extra comfortable to land on, but we will make it for you with a solid vinyl top if you prefer. Any solid or contrasting color combination available.



AVAILABLE SIZES: 5' X 10' X 4", 7' X 10' X 4"
custom sizes available

12 Carolina Trampoline Throw Mat

Made with soft denim working surfaces and vinyl sides, these mats were originally designed as a trampoline throw mat, but are useful in many ways around the gym. **(not pictured)**



DIMENSIONS: 4' X 6' X 4"

13 Carolina 32" Pits

Above ground style. Available in standard sizes and any custom size. Lattice construction at bottom of pit is topped with solid soft foam for the forgiveness you need in a pit. Perfect for drills. Use smaller sizes for maneuverable stunt pits. Made with handles on all sides and bottom edges so the pit can be positioned with minimal effort.



AVAILABLE SIZES: 5' X 10', 6' X 12', 8' X 16'



ADDITIONAL PRODUCTS

Carolina Custom Mats

Need a custom size above-ground pit? No problem. Want a combination in-ground resi/loose foam pit? We can help you figure out the hardware you need and all the matting necessary to keep all your training areas safe and looking great!



PROGRESSION SHAPES & PRESCHOOL MATS

1 Carolina Wedges

Gravity... remember when it was your friend? Carolina Wedges make it work for you again! The only incline mats on the market with handles on all sides and a dense high quality firm filler foam that will stand up to years of tough use. Ideal for downhill tumbling progressions and preschool landscapes. They come in six sizes. Larger wedges are available folding or non-folding. Folding wedges take up less space and do double duty as spotting blocks or preschool blocks. The 4' X 6', 5' X 7', and 6' X 12' folding wedges have the numbers 3, 2, and 1 respectively in appliqué vinyl on the side. This allows you to identify them quickly or use them as an awards stand.



AVAILABLE SIZES:

- 2' X 4' X 14" to 2" - tot and preschool
- 3' X 6' X 16" to 2" - youth, economical but narrow
- 4' X 6' X 16" to 2" - youth single skill
- 5' X 7' X 18" to 2" - youth to adult size single skill
- 5' X 10' X 22" to 2" - all, two skills for small youth
- 6' X 12' X 26.5" to 2" - all, two skills for adult

2 Carolina Multi-Wedge Transformer System

This system comes with a series of double-sided hook straps and single sided hook flaps to allow you to securely connect them to make a variety of training shapes. A mat mountain, a 12' downhill where the coach can kneel to spot, blocks, wedges... the sky's the limit. A true Carolina Gym Supply original!



Dimensions: (2) 60" X 72" X 18" to 0"
(2) 48" X 72" X 18" to 0" folding wedges



3 Carolina Handspring Pro

The Carolina Handspring Pro is the only back handspring trainer that teaches the full progression to the handspring skill. When used with our "stuffer" piece as a complete cylinder it gives the athletes the support they need until they can maintain a properly arched position as they roll back over the cylinder. Once they have that part down, remove the stuffer piece. If the athlete fails to maintain the arch until their body weight is to the other side of their hands, the Handspring Pro simply won't allow them to complete the skill. Sold with or without the stuffer.



AVAILABLE SIZES:

- 32" - 50" and under
- 36" - 51" to 60"
- 40" - 60" to 67"
- 44" - 67" and over



PROGRESSION SHAPES & PRESCHOOL MATS

4 Carolina Octagons

With sizes to fit tots to high-schoolers, our octagons are the most shoulder-saving tumbling training tool ever created! Octagons shine teaching the little ones to do their first bridges, and are truly indispensable for all of your classes learning walkovers and handsprings.



AVAILABLE SIZES:

- 15" X 24" - tots
- 20" X 28" - preschool, ages 3-5
- 25" X 30" - ages 5-7
- 30" X 36" - ages 7-11
- 36" X 36" - high-school age/ adults
- 40" X 40" - anyone over 5'6"

5 Carolina Octagon Halves

Our largest size octagons are available in halves, making them twice as useful. Use the halves for your little ones for bridges and as fun shapes and fasten them back together for your larger class kids to handspring over as a whole. Halves fasten on both ends with tenacious hook and loop fastener. Handles on each piece make them easy to position.



6 Carolina Trapezoids

Perfect for a vault station, stackable and individual spotting blocks or preschool blocks, the Trapezoid is a great choice for any gym or mobile program. We use flaps rather than straps for connecting sections. Flaps are much quicker and more secure than straps. The flaps go from a lower section to a higher section. This way you know the matching hook and loop fabric has been secured and the flap is not dragging the floor picking up lint. Stiff urethane foam with a crosslink foam top on each section gives the solidity coaches want. Each section is a different color. Available in the three section, "Mouse Trap" and the four section "Rat Trap". Also available is the popular "Triceratops" - a four section trapezoid with the top section in three pieces.



7 Carolina Kids Tumble Bunny Square

A series of three wedges that come off of a center block with a Carolina Two Step Cushistair. Tots do not get tired of this fun configuration! The top surface of each shape is a different color to aid color recognition skills. There are so many ways to incorporate this unit assembled or as parts into your preschool curriculum. (not pictured)

The optional Transformer-Style Tumble Bunny features enhanced hook and loop application to all component parts of the T-Bunny Square. Wedges can be fastened face to face to make blocks or steeper wedges. The wedges can also be fastened side by side for log rolls, or go end to end for uphill-downhill. (pictured)



Dimensions: (3) 2' X 4' X 14" to 2" wedges, 24" X 24" X 14" center block, 24" X 21.5" X 14" cushistair



7

8 Carolina Kids Ball Pit

We made this the first time as a special request and it was such a great idea, it's a permanent Carolina fixture! The pit fastens together with super snug fitting hook and loop fastener. At 5' X 5', it fits in a tumble bus and is an excellent addition to a preschool area. Breaks down for easy storage. Balls sold separately.



DIMENSIONS: 4" thick foam, 5' X 5' base, 24" high walls

8



9 Carolina Corral Mat

Carolina Corral Mats are the perfect versatile mats for your preschool program. Use them to create hurdles, keep kids "corralled," create a maze, and so much more! Available in any of our standard colors, each mat is made of 8" foam that is stiff enough to stand upright on its own. Hook fastener all along the bottom of the mat makes them adhere easily to Carpet Bonded Foam and carpet. With 8" X 8" loop fastener on one end and a 4" X 8" flap of hook fastener on the other, there are endless configurations to be had with these mats!



DIMENSIONS: 30" X 60" X 8"

9



PROGRESSION SHAPES & PRESCHOOL MATS

10 Carolina Kids Donut Halves

The ultimate play shape, kids are drawn to the size and colorful nature of these big roly-polys. Made standard in halves that can connect to create a whole donut, these shapes are great as rockers, tunnels, curvy fat beams or one large circle. Your preschool kids will love thinking of new ways to use these fun shapes! Whole donut shapes also available upon request.



AVAILABLE SIZES: 18" X 52" and 30" X 60"

11 Carolina Octagonal Donuts

Available in the same dimensions as our circular Donut, your athletes will have fun with these groovy shapes!



12 Carolina Mailbox

A fun beginning tumbler shape!



DIMENSIONS: 36" X 16" X 20"

13 Carolina Cushistair

You will find endless uses for these little gems in your gym. Great to step up on to low beam, they also work well in conjunction with wedges for climb up-roll down activities the little ones love. Stiffer foam gives improved performance and longevity to these steps. Available in Two Step or Three Step options.



DIMENSIONS:

Two Step: 21.5" X 24" X 14"

Three Step: 32" X 24" X 21"

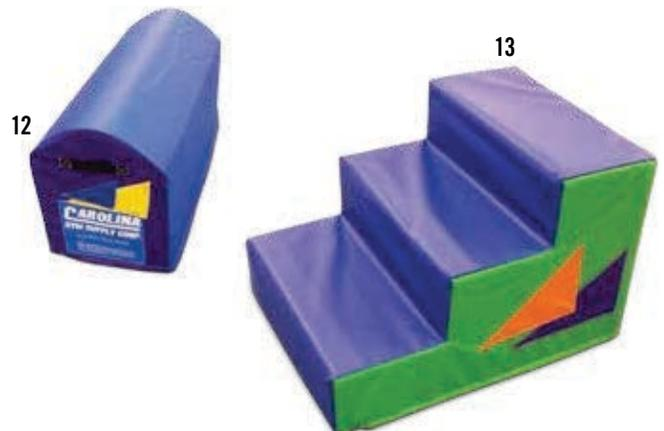

14 Carolina Kids Speed Bumps

They don't slow kids down, but they are useful in many ways like motor coordination development and game playing. Get two sets – they're small.



DIMENSIONS: 3.5" X 4" X 30"



15 Carolina Kids Tunnel Hopper

A fun and economical piece for any preschool or mobile program. What little one can resist crawling through the tunnel or skipping down this colorful sidewalk?!



DIMENSIONS: 24" X 24" X 96" unfolded



16 Janssen-Fritsen Star Wall Bars

New from Janssen-Fritsen, this repositionable piece of equipment is an excellent base for kids learning basic motor skills. Use in combination with accessories such as slides, ladders and balance boards to create endless circuits for your little ones. Exceptionally easy to store and move wherever needed! Comes with mats, as shown.



FOLDS EASILY TO
STORE OR MOVE
WHEN NEEDED



16



PROGRESSION SHAPES & PRESCHOOL MATS

17 Jr. Kip Bar

This mini bar is perfect for home use and features longer bases for added stability, making it usable for a larger age range of gymnasts. The base unit with rail adjusts from 38" to 59" and can be used for swinging skills for athletes up to 70 lbs. Add extension bases (sold separately) or a piece of 4' X 8' X ¾" plywood to enable athletes 70-100 lbs. to safely use the Jr. Kip Bar. Add both the extra bases and plywood to stabilize the bar for athletes over 100 lbs. For institutional use, ask us about the Jr. Bar Pro!



RAIL ADJUSTMENT: 38" to 59"

18 Carolina Colorful Vinyl Beams

Our most basic balance beam, 4" wide X 4' or 8' long hook fastener topped with our colorful vinyl. Use them for all levels to learn new skills and gain confidence before taking skills to an off-the-floor beam. Also available with a non-skid backing, great for use on a panel mat or for balance exercises on a smooth floor.



AVAILABLE SIZES: 4" X 4' and 4" X 8'

19 Carolina Colorful Arrows

Fun, functional arrows are valuable to any preschool program! Use them to show little ones the way around a circuit or where to place their hands, feet, etc. Limited only by your imagination, these arrows are a wonderfully economical and creative way to perk up any preschool or mobile program. Available with hook fastener to stick to carpet or a non-skid backing to lie on smooth floor or matting.



20 Carolina Colorful Hands & Feet

Little ones will enjoy matching their hands on the printed vinyl. Excellent for visually demonstrating correct hand placement for beginner skills. Available with hook fastener or non-skid backing.



AVAILABLE SETS: (8 pieces) 2 pairs of hands, 2 pairs of feet, (12 pieces) 3 pairs of hands, 3 pairs of feet

21 Parachutes

Always popular for group and cooperative play. They take up no room in storage and can be used in countless games and activities. A cost-effective way to spice up classes and camps. **(not pictured)**

AVAILABLE SIZES: 12', 20' and 24'.

22 Little Thumper Springboard

Made by Speith Anderson, this small spring board is a great value for your preschool program. Use for tots up to 70 lbs.



Available Vinyl Colors



ADDITIONAL EQUIPMENT

Bean Bags

Set of 12, assorted colors. 6" X 6"

Cargo Nets

Great climbing activity for kids of all ages. Several different size options available.

page 33

Plastic Balls for Ball Pit

Poly Spots

page 12

Rubber Beam

TRAMPOLINE & TUMBLING PRODUCTS

1 Tumbl Trak

The 21" high frame with tightly sprung, purposefully designed springs gives the springiness and forgiveness athletes and coaches want. A must for any serious tumbling program.



2 Xtreme Tumbl Trak

Same as the regular Tumbl Trak except that it has a vinyl reinforced bed designed to be more durable for athletes wearing shoes, especially cheerleaders.

3 Air Floor

An absolutely brilliant product by our friends at Tumbl Trak! Not to be used alone. On a panel mat it feels like a spring floor. On a spring floor, it feels like a rod floor. Double walled fabric and high pressure sealed air provide the magic in this low-profile product. Fabulous for exhibitions. Available with or without hook/loop fastener. We recommend purchasing a cover to extend your Air Floor's warranty. Includes hand pump for inflation.

AVAILABLE SIZES: 3m, 4.5m, or 6m lengths at 3" thick



4 Air Floor PRO

Double wall technology offers a rebound like never felt before and, unlike the Air Floor, is not required to be used on a padded surface. Millions of threads sewn inside from the top to the bottom of the Air Floor PRO give this product its unique feeling. Your tumblers beginner and advanced will love it! Comes with fastener to attach several units together. Also includes electric pump for inflation.



AVAILABLE SIZES: 3m, 6m, and 9m lengths at 8" thick



AIR FLOOR
PRO INSERT



5 Air Trak

Great portable solution for a Tumbi Trak. Don't expect quite the same lift as a Tumbi Trak, but kids really love it. Includes a constant-flow blower. We highly recommend the sound case to reduce noise.

5



6 Sweet Spot

Same construction as the Air Floor, but gives you that extra boost where you need it. Use the sweet spot for tumbling take offs, blocking on vault or any other number of things. (not pictured)

DIMENSIONS: 36" X 48" X 3"

7



7 Euro Grand Master Trampoline

This is the top-of-the-line folding institutional tramp that is used in international competitions. There is no substitute. Optional End Decks available.

TRAMPOLINE & TUMBLING PRODUCTS

8 Elite Non-Folding Trampoline

An excellent trampoline for a beginning tramp program. The standout features include a rigid frame, 10" jumbo springs and the ability to accept any of the high performance beds. This tramp was designed to give a comparable bounce to the Euro Grand Master.

9 7' X 14' Straight Frame Trampoline

The high-quality, economical and versatile tramp many gym clubs seek. Can be used above-ground or in a pit. The poly bed doesn't bounce like a web bed or a string bed, but it will do the job up to the double back level. If you are working fliffises it is time to upgrade to the high performance bed, a string bed, the Elite Non-Folding Trampoline or the Euro Grand Master.

10 In-Ground Trampoline

In-ground adds extra safety and ease of use. The straight frame tramp can be dropped into your hole, or we can make an economical frame, springs, bed and pads to save you money and fit the size of your hole. Simply bolt the metal frame sections to the top of your pit, string the bed, velcro on the pads and, voilà – awesome pit tramp! Choose 9" or 10" jumbo springs, poly bed, high performance poly bed or string bed depending on your need for big air.



11 In-Ground Tumble Trampoline

The added safety, not to mention the money saved, make this an indispensable part of your in-ground pit system. Rather than dropping an expensive above-ground unit into a hole, just bolt the angle iron framework to the top of your pit walls, string the bed, add pads and you have a tumbler's heaven. Call for dimensions and guidelines before digging any pit. *(not pictured)*

12 Double Mini Trampoline

Competition ready. An exciting new event to add to your program. Available with various springs and bed configurations.

13 Jumbo High Performance Mini Trampoline

Offers amazing performance for the price. The 24" X 24" poly bed gives a big takeoff target and the 9" springs will put you into orbit. Easily adjustable in height. Unique design can be shipped easily via UPS! *(not pictured)*



ADDITIONAL PRODUCTS

14 Economy Mini Trampoline

This entry-level mini trampoline gives good bounce at a great price! Easily shipped via UPS.



15 Aluminum Frame Rod Floor

Sections are constructed with durable lightweight aluminum for easy shipment and transportation. Strong fiberglass rods give maximum air. Use hook fastener strips to secure scrim backed and carpet bonded foam to the rod floor.

DIMENSIONS: 6' X 4' each section

14



15



Trampoline End Decks

Add these decks for enhanced safety.

2" Scrim Backed Foam

Similar to carpet bonded foam but using a less expensive "scrim" material. For use on rod floors. The scrim side goes down against the fiberglass rods to prevent the foam from splitting between the rods. Carpet bonded foam goes over the scrim backed foam to complete the rod floor construction.

Carolina Double Mini Landing Mat System

This mat system is composed of four 5' X 10' X 12" mats with hook and loop fastener to create a cohesive landing system. Add a 6.5' X 13' yellow landing zone cover that attaches via hook and loop fastener.

Trampoline Pads

We've made pads in all sizes and configurations. Call for a quote today!



Trampoline Springs

Trampoline Pad Lifters

2" SCRIM BACKED FOAM



TRAMPOLINE PADS



TRAINING PRODUCTS

1 Overhead Spotting Rigs

Standardly mounted to the ceiling with I-beam clamps or other ceiling hardware. Because the unit is stationary, placement with respect to the apparatus is critical. If you do not have an I-beam exactly in the place you need it, consider suspending the rig from a cable system similar to the traveling overhead rig. Stoppers installed on the cable assure that the rig does not travel. Call for consultation with one of our professionals. (traveling rig pictured)

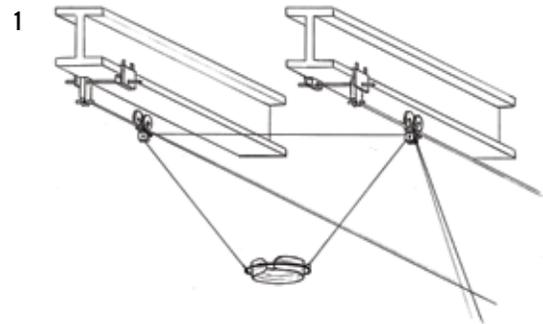

2 Tumbling Belt with Quick Release Buckle

Spend your time spotting, not waiting for kids to get in the belt. Super secure yet easy and comfortable for the athletes. Optional leg straps keep the belt from riding up and maintain proper center of gravity.

AVAILABLE SIZES:

Small: waist 18" - 28"

Large: waist 24" - 36"

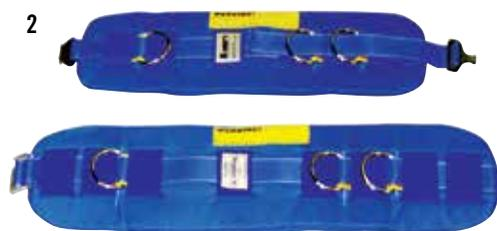

3 Super Twisting Belt

Comfortable padded, precision bearing action, solid construction, the best twisting belt we have found. Use it with tethers or overhead rig.

AVAILABLE SIZES:

Small: 11.5" diameter ring

Medium: 12.5" diameter ring

Large: 14.5" diameter ring



4 Climbing Ropes

You cannot beat rope climbing for strength conditioning. One of the very best ways we know to enhance your program and strengthen your kids for a minimal investment. Get two – a race will keep their head in the game and is more of a challenge for your athletes! Put a bell at the top for added fun.



ADDITIONAL ACCESSORIES

Gymnastics Chalk

Available by the pound or case (36 lbs.). Eight 2 oz. blocks in each 1 lb. box. Ships UPS.

Parts & Accessories

Call us for cables, floor plates, replacement T-handles, spinlocks, tramp spring, vault boards and springs. We can help you with all these things. We love to talk gymnastics and will gladly share our years of accumulated knowledge and experience with you!

POLICIES & ORDERING INFORMATION

Orders

The most effective way to order from Carolina Gym Supply is to call us at 877-GYM-STUF (877-496-7883) from M-F 8am-5pm EST. You can also email us at info@carolinagym.com or fax us at 919-732-1510. Please be sure to put a return phone number on your fax. At the time of order we can tell you what all your charges are including freight and how much and when you will need to pay. We will also give you an estimate of the time frame in which you can expect your order.

Internet Orders

Due to the variety of colors and design features, we currently do not offer the ability to complete an order with payment online. You can place a quote request through our website, and once submitted we will work to figure shipping costs for your items. One of our sales representatives will then contact you with shipping costs and estimated production times.

Color Policy

All Progression Shapes and Preschool Mats will be made in standard multicolor unless specified at time of order. Standard multicolor is a combination of three of our 11 vinyl colors.

Prices

Prices are subject to change without notice. Bids and written quotations on products are valid for 30 days (shipping and freight quotes are valid 7 days). Sorry, verbal quotes cannot be guaranteed. Individual product prices do not include applicable taxes or shipping charges.

Shipping

Production times on orders for matting vary throughout the year. Production time will be discussed with you at time of order. Please note that many of our larger mats are shipped disassembled to prevent damage during transportation and lower freight costs for you, the consumer.

Smaller items such as grips, vinyl beams and some small mats can ship UPS. Other matting items or apparatus ship via common carrier, dedicated truck or a pre-arranged delivery to your facility by Carolina Gym Supply. Method of shipping will be discussed with you at time of order.

THINGS YOU MUST KNOW ABOUT MOTOR FREIGHT:

1) We will make every attempt to contact you with your PRO (tracking) number of your shipment and a local phone number for your carrier. We will tell you the estimated delivery date of your freight and how many pieces you are expecting. It is the customer's responsibility to coordinate deliveries with the freight carrier.

2) It is the customer's responsibility to remove the freight from the truck upon arrival. The drivers are usually helpful, but this is the consignee's (customer's) responsibility. Please be aware of this and schedule to have help available when your shipment arrives. Certain products are palletized and you may need something to cut metal banding and work gloves to safely offload your freight.

3) It is the customer's responsibility to inspect the freight upon arrival. If freight is damaged, it MUST be noted on the delivery receipt BEFORE you sign. It is the customer's responsibility to choose to keep the freight and file a claim or refuse damaged goods for return and replacement. If you have freight damage, please call us at 877-496-7883 and we will give you additional information about the claim or return process.

4) Carolina Gym Supply will not assume responsibility for any freight damage and all claims must be made by the customer directly to the freight carrier within the parameters of the carrier's claim process.

Sales Tax

Sales that result in shipment of products within NC are subject to the NC State Sale Tax rate, assessed on product(s) and any applicable shipping charges.

Payment

Carolina Gym Supply Corp accepts American Express, Visa, Master Card, Discover, personal and business check, or wire transfer as a means of payment. Generally all orders are prepaid. We will tell you at the time of order exactly how much is due and when it needs to be paid. If you are using extended credit, please be aware that any balance that goes over 30 days is subject to 1.5% monthly, 18% annual finance charge.

Custom Orders

Carolina Gym Supply Corp has always specialized in producing unique and custom matting solutions for our customers. We will gladly do custom work to your specifications. We may ask for this information in writing, or ask you to sign off on a design specification and drawing we provide to you before we will begin work on a custom project. All custom orders must be prepaid and are not returnable.

Returns

We will accept returns of standard items (NO custom items) with a 15% restocking fee providing they have never been used and customer pays all applicable freight and handling charges on the return. Return authorization is required.

Warranty

We have every confidence that all our products will stand up to the use for which they are intended. All Carolina Gym Supply products are covered by a standard one year manufacturer's warranty against product defects and faulty workmanship. The user assumes all risk when purchasing and using any product listed in the catalog or sold by Carolina Gym Supply. Damage to product caused by misuse or extreme use is not covered under warranty.

Safety Warnings & Prop 65 Notice

Be safe! Carolina Gym Supply is dedicated to the sport of gymnastics and is dedicated to safety. The warning below appears on all our mats. Make sure you read it, and please have every coach and gymnast that enters your gym read it. Inspect all matting and apparatus on a daily basis for signs of excessive wear. Replace parts prone to stress and wear on a regular basis. Carolina Gym Supply products are not toys.

Any activity involving motion or height creates the possibility of accidental injuries. This mat is intended for USE ONLY by properly trained participants under supervised conditions. Use without proper supervision could be DANGEROUS and should NOT be undertaken or permitted. Before using, KNOW YOUR OWN LIMITATIONS and the limitations of this mat. If in doubt, always consult a qualified professional. AVOID landing on head or neck as serious injuries or death may result. For CA residents: This product contains chemicals known to the state of California to cause cancer and birth defects or other reproductive harm.

Janssen-Fritsen Nitro-Assist Beam

Page 10



Carolina Level 4 Vault Mat Systems

Page 26



Carolina Rainbow P-Bar Half Blocks™

Page 22



Carolina Trench Bar Pit System

Page 8



8' Adjustable Bolt Down Single Training Bar

Page 6

575 Dimmocks Mill Road Hillsborough, NC 27278
TOLL FREE: 877-G₄Y₉M₆-S₇T₈U₈F₃ | PHONE: 919-732-6999 | FAX: 919-732-1510

www.carolinagym.com | info@carolinagym.com



CAROLINA ***GYM SUPPLY CORP.***

575 Dimmocks Mill Road Hillsborough, NC 27278
TOLL FREE: 877-G₄Y₉M₆-S₇T₈U₈F₃ | PHONE: 919-732-6999 | FAX: 919-732-1510

www.carolinagym.com | info@carolinagym.com