



USER MANUAL

PX259 Prime S White

The color and the appearance may differ depending on the product, and the specifications are subject to change without prior notice to improve the performance. The contents of this manual are subject to change without notice to improve quality.

Copyright © 2022 Pixio USA Inc. | Pixio is a registered trademark of Pixio USA Inc. | All Rights Reserved.
Use or reproduction of this manual in parts or entirety without the authorization of Pixio USA Inc is prohibited.
All other trademarks are owned by their respective owners. Rev.1.0

Brand: Pixio
Product Name: 25in IPS FHD 360Hz Gaming Monitor
Product Code: PX259PSW
FCC ID: BCTC2111902659E



This device complies with part 15 of the FCC Rules. Operation is subject to the following two conditions: (1) this device may not cause harmful interference, and (2) this device must accept any interference received, including interference that may cause undesired operation. Any changes or modifications not expressly approved by the party responsible for compliance could void the user's authority to operate the equipment.

NOTE: This equipment has been tested and found to comply with the limits for a Class B digital device, pursuant to Part 15 of the FCC Rules. These limits are designed to provide reasonable protection against harmful interference in a residential installation. This equipment generates, uses and can radiate radio frequency energy and, if not installed and used in accordance with the instructions, may cause harmful interference to radio communications. However, there is no guarantee that interference will not occur in a particular installation.

If this equipment does cause harmful interference to radio or television reception, which can be determined by turning the equipment off and on, the user is encouraged to try to correct the interference by one or more of the following measures:

- Reorient or relocate the receiving antenna.
- Increase the separation between the equipment and receiver.
- Connect the equipment into an outlet on a circuit different from that to which the receiver is connected.
- Consult the dealer or an experienced radio/TV technician for help.

JOIN THE RED TEAM

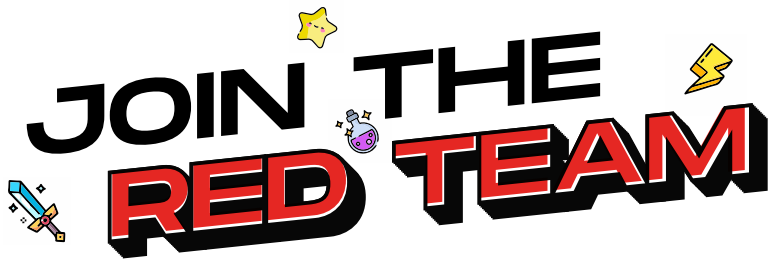

Keep up to date on the latest news, take part in giveaways, and interact with us!



**RISK OF ELECTRIC SHOCK DO NOT OPEN THE MONITOR.
OPENING MONITOR BACK COVER WILL VOID YOUR WARRANTY.**



This symbol indicates that high voltage is present inside.
It is dangerous to make any kind of contact with any internal part of
this product.



This symbol alerts you that important literature concerning operation
and maintenance has been included with this product.

Before Using the Product.



Installation Space

Ensure some space around the product for ventilation. An internal temperature rise may cause fire and damage the product. Make sure to allow some space. Do not install near heater or any other high temperature product or humidifier.



- Do not place the monitor near heat sources, such as radiators, and do not expose the monitor to direct sunlight for an extended period of time.
- Make sure to keep the original packaging material. If there are any needs to transport the monitor, the packaging material will be the best method for successful delivery.
- Make sure to use a soft, non-abrasive cloth when cleaning the monitor. Do not use corrosive or strong detergents to clean the monitor. They may result in permanent damage to the panel and will void the warranty.
- Always check to make sure the power cord is unplugged before cleaning the monitor.
- Be careful when handling liquids while cleaning as it may cause irreparable damage to the electrical components in the monitor.



- Make sure the monitor is not placed near any source of water, such as the bathroom, kitchen, or humid areas.
- Do not place the monitor on an unstable, or uneven surface. If dropped, the monitor may cause bodily injuries. When transporting the monitor, make sure it is secured in an upright position or preferably in its original packaging for best results. When mounting the monitor, make sure to follow the instructions of the respective mounting provider for best results.
- The openings in the monitor are for ventilation. For best results, make sure the ventilation holes are not covered up. Avoid confined spaces like a bookcase for proper functionality.
- If the monitor will not be used for an extended period of time, make sure to unplug the power cord to prevent the risk of damage from lightning strikes or other abnormal voltage incidents.
- Do not overburden any socket to prevent risk of fire or shock.
- Do not stick any foreign objects into the monitor to prevent risk of fire or shock.
- Please do not try to take off the back panel to repair the monitor yourself. You may run the risk of shock and void the warranty as well. Contract Pixio directly for all RMA issues.
- Take note of elevation and temperature zone warnings on the adapters.
- The  icon indicates that the adapter is suited for areas under 2000 meters.
- The  icon indicates that the adapter is suited for non-tropical areas.

Cleaning the Product.

Take the following steps when cleaning.

1 Power off the product and computer.



2 Disconnect the power cord from the product.

Hold the power cable by the plug and do not touch the cable with wet hands. Otherwise, an electric shock may result.



3 Wipe the monitor with a clean, soft and dry cloth.

Do not apply a cleaning agent that contains alcohol, solvent, or surfactant to the monitor.

Do not spray water or detergent directly on the product.

4 Wet a soft and dry cloth in water and wring thoroughly to clean the exterior of the product.

5 Connect the power cord to the product when cleaning is finished.

6 Power on the product and computer.

Notice.

Characteristics of Crystal Display Monitors

When the following potential issues occur, please be aware that the monitor is functioning in accordance of manufacturing tolerances and does not mean the monitor has a defect.

- When first turning on the monitor, the screen may flicker. Please turn the monitor off and turn it back on.
- The brightness levels on different images may appear uneven.
- The effective pixel count should approximate 99.99%, but there may be a possible 0.01% or less failure rate due to dead or stuck pixels.
- If the monitor displays a single static image for a long period of time, there may be an image burn that can be seen while viewing a different image. The burned image will gradually disappear and turning off the monitor for an extended period of time will speed up the process.
- If you notice extended, constant flickering or if the screen constantly goes to black, please contact Pixio directly and we will assess and have the unit repaired if necessary. Please do not attempt to repair the unit yourself as it will result in voiding the warranty.

Preparation.

Product Includes:

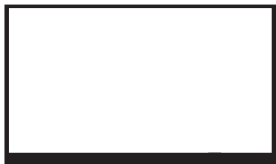

Monitor



Stand Stem



Stand Base

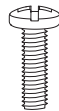

M4*12mm Screw



Power Adapter

Product Assembly:

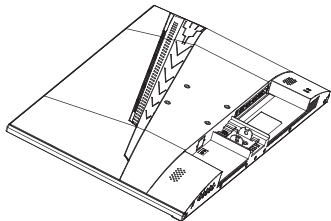

- 1 Open the package, take out the product with foam still attached, and gently place it on a desktop or table.

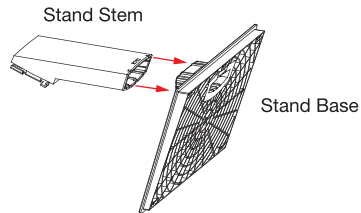

- 2 If you connect the stand stem to the base and hear a "click" sound, it means the installation is complete.

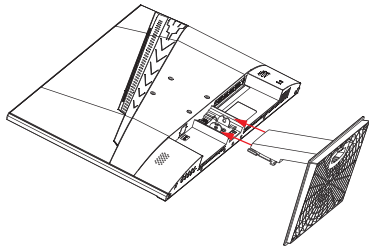

- 3 Insert the completed stand into the back of the monitor as shown in the illustration.

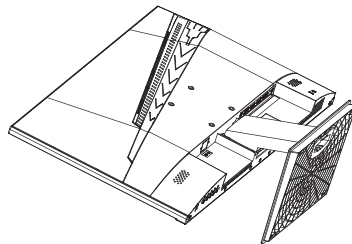

- 4 Stand assembly completed.

Product Disassembly:

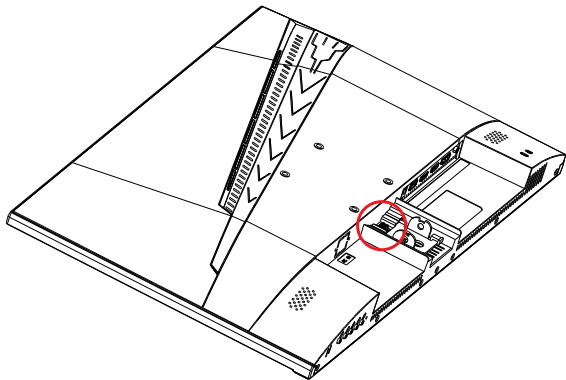

- 1 Place the monitor face down on a flat protected surface gently.
- 2 Gently press the push button near the stand, and slide out the completed stand from the back of the monitor.

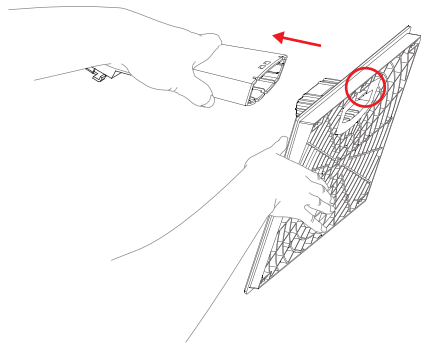

- 3 Lift up the small bar underneath the stand stem slightly, and then pull out the stand stem from the stand base.

Dimension & Weight.

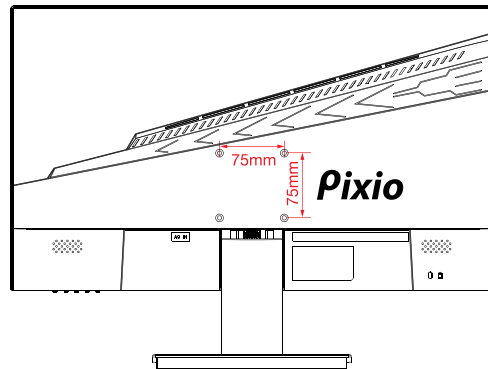
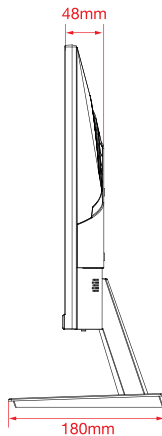
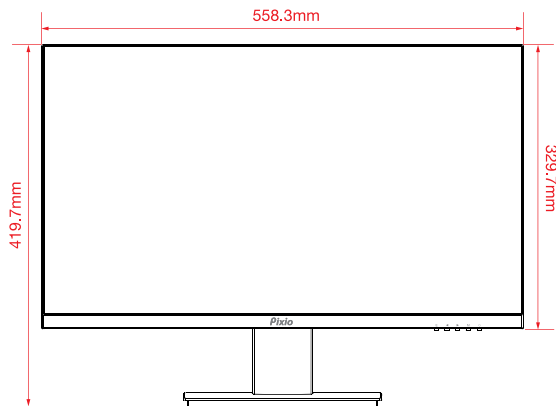

Net Weight: 4.2kg (9.26lb) | Gross Weight: 5.2kg (11.46lb)

Monitor Inputs.

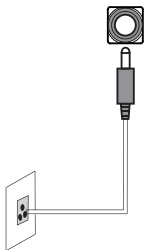
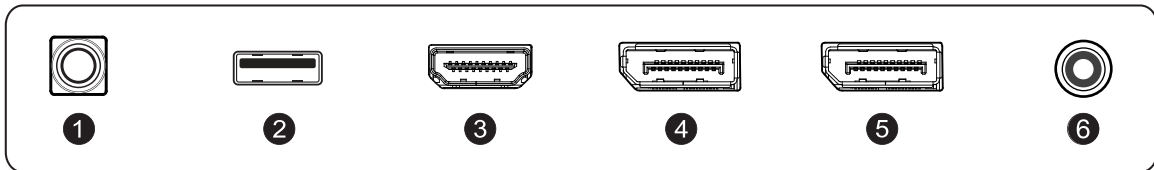

- ① DC
- ② USB Firmware Update
- ③ HDMI HDMI 2.0, 240Hz, Adaptive Sync, HDR
- ④ DP2 DisplayPort 1.4, 360Hz, Adaptive Sync, HDR
- ⑤ DP1 DisplayPort 1.4, 360Hz, Adaptive Sync, HDR
- ⑥ Earphone

***WARNING:**
Always use the appropriate power cord.

Control Panel.

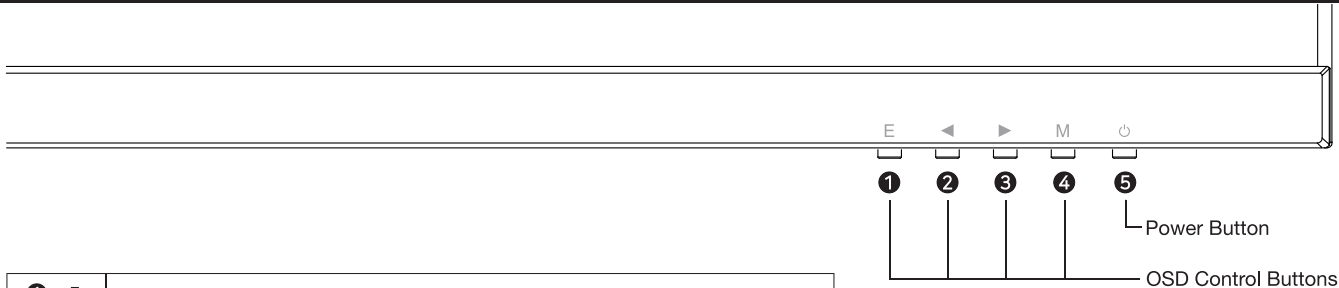

① E	Input selection Short Key
② ◀	Preset selection Short Key
③ ▶	Crosshair(LoS) selection Short Key
④ M	Open the Main OSD Menu
⑤ ⏻	Turn the monitor On or Off

Short Key Guide

- ① Activate the Signal Input Selection menu. Use ◀ and ▶ to navigate and M to select the source.
- ② Activate the Preset Feature. Further press to cycle through the preset.

Main OSD Navigation.



How to Reconfigure

E	Exit the Main OSD Menu.
◀	Go Up on the Main OSD Menu / Decrease the value of a selected item.
▶	Go Down on the Main OSD Menu / Increase the value of a selected item.
M	Open OSD Menu / Enter to next level of the menu / Select highlighted item.

OSD Menu.



Input

- Switch the Signal Input from Auto Select, DP1(1.4), DP2(1.4), or HDMI(2.0)

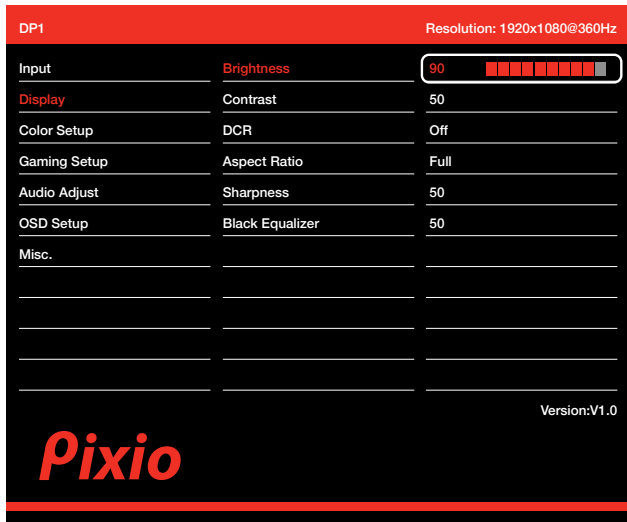

Display

- **Brightness:** Adjust Brightness value from 0 to 100.
- **Contrast:** Adjust Contrast value from 0 to 100.
- **DCR:** Turn DCR On or Off
- **Aspect Ratio:** Select the Aspect Ratio from Full, 4:3, 16:9 or Auto
[Disabled when turn on the FreeSync or Changing the Preset]
- **Sharpness:** Adjust Sharpness value from 0 to 100.
- **Black Equalizer:** Adjust Black Equalizer value from 0 to 100.



Color Setup

- **Gamma:** Select from 1.8, 2.0, 2.2, 2.4 or 2.6.
- **Preset:** Select from Standard, Photo, Movie, User, FPS, RTS, or Normal
- **Color Temperature:** Select from Normal, Warm, Cool, or User.
- **Hue:** Adjust Hue value from 0 to 100.
- **Saturation:** Adjust Saturation value from 0 to 100.
- **Low Blue Light:** Adjust Low Blue Light value from 0 to 100.



Audio Adjust

- **Mute:** Turn Mute On or Off.
- **Volume:** Adjust Volume value from 0 to 100.

DP1		Resolution: 1920x1080@360Hz
Input	Language	English
Display	OSD H. Position	99
Color Setup	OSD V. Position	8
Gaming Setup	Transparency	20
Audio Adjust	OSD Timer	15
OSD Setup	OSD Rotation	Normal
Misc.		

Version:V1.0



Setup Menu

- **Language Select:** Change the OSD menu display language.
- **OSD H. Position:** Adjust the OSD H. Position value from 0 to 100.
- **OSD V. Position:** Adjust the OSD V. Position value from 0 to 100.
- **Transparency:** Adjust the Transparency value from 0 to 100.
- **OSD Timer:** Adjust the OSD Timer value from 5 to 100.
- **OSD Rotation:** Select from Normal, 90, 180, or 270.

Adaptive-Sync

Adaptive Sync technology is a solution that eliminates screen tearing without all the usual lag and latency. This feature will eliminate screen tearing and lag during game play. Improve your gaming experience. The displayed Adaptive Sync menu items on the monitor may vary, depending on the monitor model and compatibility with the AMD graphics card.

Nvidia G-Sync

If you are using Nvidia GTX 10series or RTX20series graphic cards, you can use Adaptive-Sync function. This requires Nvidia's latest GPU updates. Please download the latest update if you are intended to use Adaptive-Sync over your Nvidia GTX graphics cards.

How to enable Adaptive Sync on Nvidia GPU

- 1 Right-click on the Windows desktop and select Nvidia Control Panel
- 2 Expand the Display section of the left-hand navigation pane and select Set up G-Sync
- 3 Check the "Enable G-Sync, G-Sync Compatible" box and select the Active Sync display you'd like to use if you have more than one monitor
- 4 Check the "Enable settings for the selected display model" box
- 5 Click "Apply" in the bottom-right

***If the above isn't available, or isn't working, you may need to go to Manage 3D Settings, click the Global tab, scroll down to Monitor Technology, select G-SYNC Compatible in the drop-down, and then click Apply

***Even though AMD Radeon GPUs and some Adaptive Sync monitors support Adaptive Sync over HDMI, Nvidia says you'll need to connect your GeForce GPU to your Adaptive Sync monitor using a DisplayPort cable to activate variable refresh rates. (G-Sync monitors only work over DisplayPort as well.)

Pixio

If you have any questions or comments, please contact us below.

USA:

cs@pixiogaming.com

JAPAN:

support@pixiogaming.jp

www.pixiogaming.jp/support

For your warranty information, please visit www.pixiogaming.com



Misc.

- **Flicker Free:** Turn Flicker Free On or Off.
- **Firmware Update:** Firmware Update from Cancel or Confirm.
- **RGB Light:** Turn RGB Light On or Off.
- **Reset:** Select Reset from Cancel or Confirm.