



AQUABLU

Official Distributor

(800) 971 1442

www.aquablumosaics.com

WOOSAH

IN-POOL LOUNGE CHAIR

SPLASH Series

The most comfortable in-pool chair is here. Take a seat in the Woosah Chair and let your Shoulders and Arms Relax. Now take a deep breath and say "Wooooo-saaaaah" while slowly exhaling. Repeat until you feel the tension wash away.

The ergonomic contouring of the seat makes for a very comfortable chair. The seat is made with soft contoured, rotationally molded polyethylene that can withstand sun, rain, snow, ice and pool chemicals.

- Designed for in-pool use and has zero metal components.
- Great ergonomic seat profile and tall backrest.
- Supports up to 350 lbs
- Easy to add to the pool and easy to remove from the pool. No screw plugs to deal with.
- Leg bases are rounded for use in all types of pools, including vinyl liner.



PRODUCT INFO

#SPLWOOSAHBX_ : - Splash Woosah, Tall Base, Max Water depth 13"

#SPLWOOSAH2BX_ : - Woosah Splash with Tall Base, 2 Chair Combo Pack in 1 Box

Woosah with this base give the user a normal "Adirondack Chair" seating height for optimal comfort in the pool or on the patio. If you have a sun shelf with water depth of 13" or less you'll be able to leave this chair in the pool and it will resist movement from light waves and wind. If you have water depth over 13" you can still use this chair in your pool, but when you are not sitting in the chair it could move or float as the water depth incrementally increases above 13". This chair is easy to place in your pool and remove from your pool and use on your patio. There are no drain plugs that trap water in the core of the chair and this allows pool water to constantly recirculate within the core of the chair and allows the chair to drain and dry when removed from the pool.

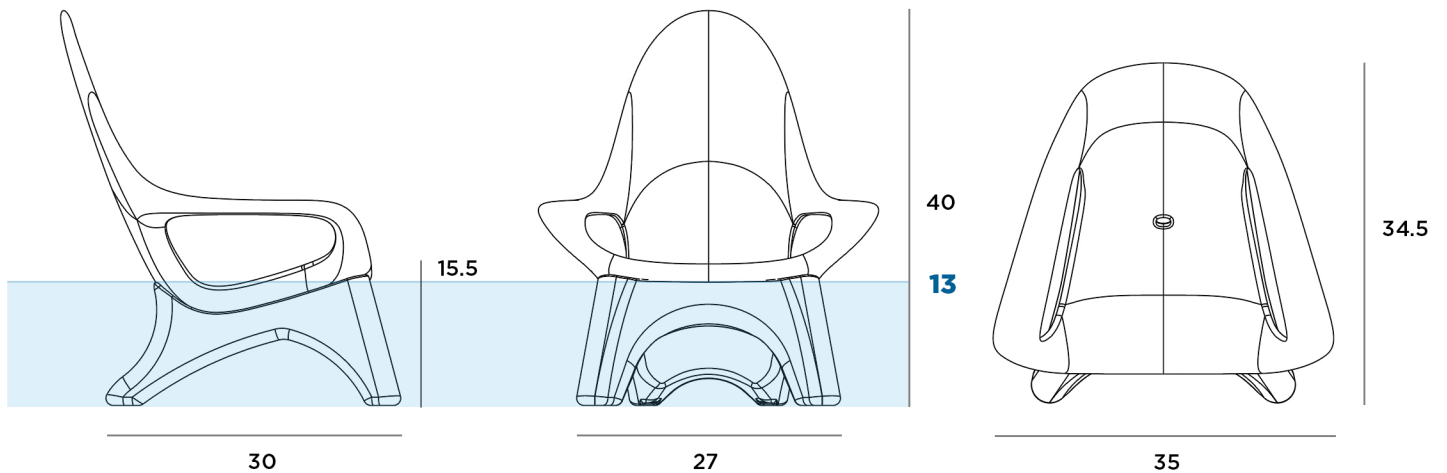

STANDARD COLORS

2 digit color code corresponds to the blank spaces in the product SKUS.

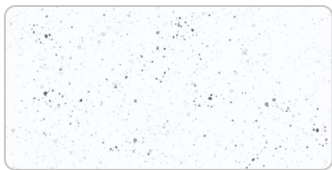

White Granite (WG)

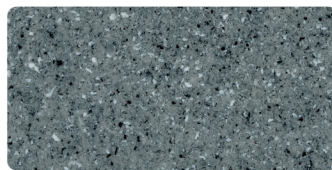

Gray Granite (GG)

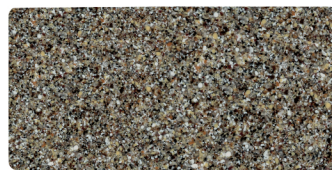

River Rock (RR)



Desert Sandstone (DS)



Yellow (YE)



Surf Blue (SB)



Light Blue (LB)

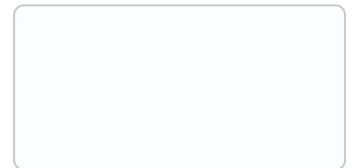

White (WH)

INCLUDED PARTS

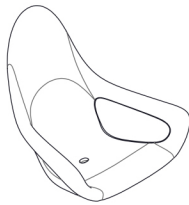

Seat

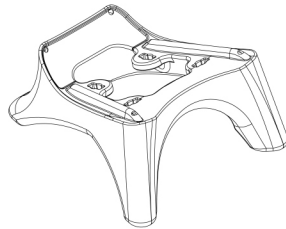

Tall Base

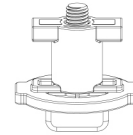

Connector (x4)

Easy assembly. No tools required.

Step 1

Spread out a towel or moving blanket. You can also cut the sides of the box so the box spreads out flat on the ground. This is to protect the seat and the base from scratching during assembly.

Step 2

Place the plastic seat upside down on the towel or blanket so the bottom of the chair is facing towards you.

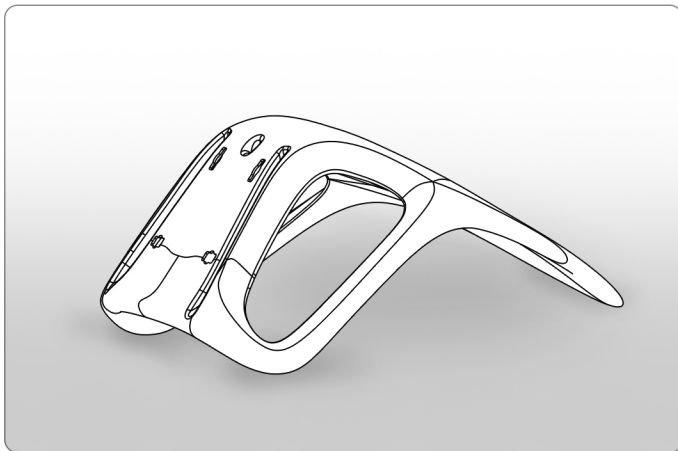

Diagram: Step 2

Step 3

Turn the connector screw knob counter clockwise to expand each connector. Align the raised ridges on the base with the channels on the bottom of the seat. Hold the pieces together while inserting all 4 connectors through base and into the bottom of the seat. You'll see the "key holes" aligned that accept the head of the connector.

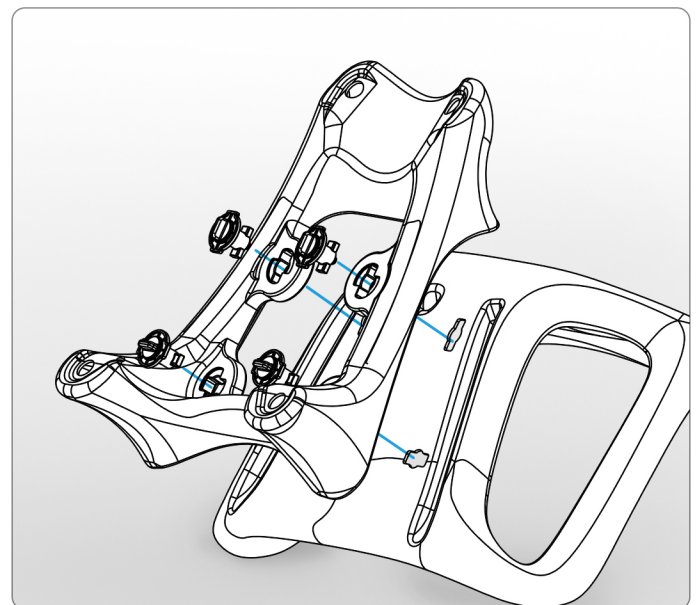

Diagram: Step 3

Step 4

Turn the outer ring of each connector to the right (clockwise) 90 degrees. Hold this outer ring at the 90 degree position while twisting the head of the center plastic screw until it is securely tightened by hand. Do not use a pliers or tools to turn the connectors. Hand tightening is enough and assembly is complete.