

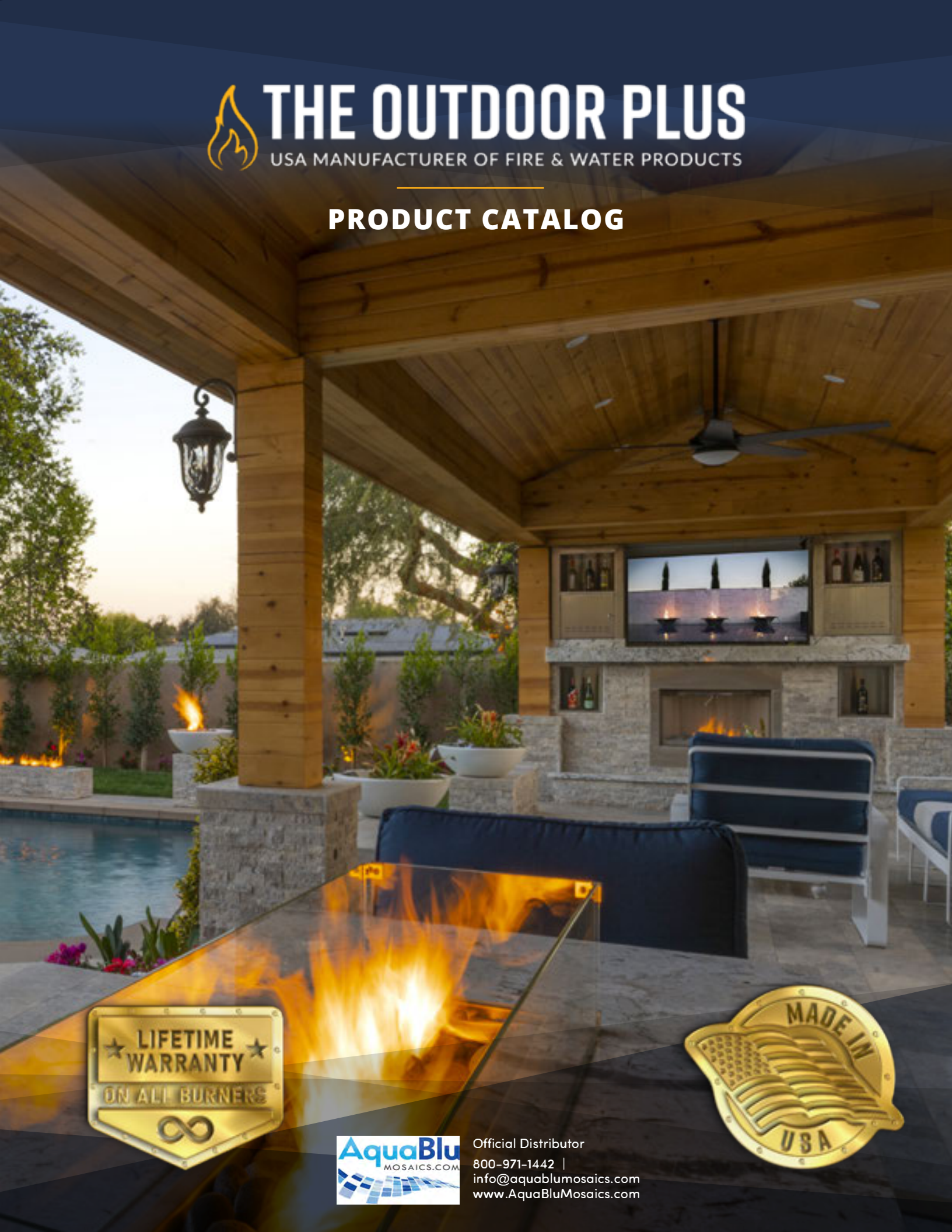

THE OUTDOOR PLUS

USA MANUFACTURER OF FIRE & WATER PRODUCTS

PRODUCT CATALOG



Official Distributor
800-971-1442 |
info@aquablumosaics.com
www.AquaBluMosaics.com

Table of Contents

TABLE OF CONTENTS

6 BOWLS

- 6 Concrete Bowls
- 18 Wood Grain Bowls
- 24 Copper Bowls
- 34 Powder Coated Bowls
- 41 What's Included In Your Bowl?

44 FIRE PITS

- 44 Concrete Fire Pits
- 56 Wood Grain Fire Pits
- 66 Metal Fire Pits

94 READY-TO-FINISH FIRE PITS

98 PROPANE TANK ENCLOSURES

100 FIRE TOWERS

102 SELF CONTAINED FIRE & WATER FOUNTAINS

106 FIRE TORCHES

- 106 Torch Heads
- 108 Torch Kits & Accessories

112 BUILD YOUR OWN FIRE PIT

114 PAN & BURNER KITS

- 114 Brass Bullet Burner Kits
- 118 Stainless Steel Bullet Burner Kits
- 124 Stainless Steel Burner Kits
- 132 Raised Lip Pan & Burner Kits
- 134 Lip-less Tray & Burner Kits

136 WATER OVER FIRE PIT INSERT

138 BURNERS

- 138 Brass Bullet Burners
- 142 Stainless Steel Burners

154 SMART WEATHER ELECTRONIC IGNITION SYSTEM (SWEIS)

- 154 12V Ignition Systems
- 154 110V Ignition Systems
- 155 Sweis Accessories & Add On's
- 155 SWEIS Replacement Components

156 SPARK IGNITION KITS

157 FLAME SENSE KITS

158 GAS KITS, HOSES & ACCESSORIES

- 158 Gas Kits
- 158 Gas Conversion Kits
- 159 Key Valves, Hoses, Timers & Fittings

162 FIRE PIT ADD ONS

- 162 Fire Pit Glass & Lava Rock
- 163 Fire Pit Lids
- 163 Access Doors
- 164 Wind Guards & Flame Guards
- 165 Canvas Covers

166 CUSTOM FIRE & WATER FEATURES

168 WARRANTY & FREIGHT POLICIES

170 COLOR & MATERIAL SWATCHES



TOP FIRES

Bowls, Fire Pits & Other Finished Goods





24" ASH

Cazo Planter Bowl

Includes: Bowl Only (Soil and plants not included.) (3" Opening)

24" Bowl OPT-24RP

- » Size: 24"
- » Height: 9"
- » Base: 9"
- » Soil Usage: 1 ft³

31" Bowl OPT-31RP

- » Size: 31"
- » Height: 10"
- » Base: 10"
- » Soil Usage: 2 ft³

36" Bowl OPT-36RP

- » Size: 36"
- » Height: 12"
- » Base: 14"
- » Soil Usage: 3 ft³

48" Bowl OPT-48RP

- » Size: 48"
- » Height: 16"
- » Base: 20"
- » Soil Usage: 1 ft³



24" BROWN

Cazo Planter & Water Bowl

Includes: Bowl, Copper Scupper (¾" Inlet) (3" Opening)
(Soil and plants not included)

24" Bowl OPT-24RPW

- » Size: 24"
- » Height: 9"
- » Base: 9"
- » Scupper: 8"
- » Soil Usage: 1 ft³
- » GPM: 7-10

31" Bowl OPT-31RPW

- » Size: 31"
- » Height: 10"
- » Base: 10"
- » Scupper: 8"
- » Soil Usage: 2 ft³
- » GPM: 7-10

36" Bowl OPT-36RPW

- » Size: 36"
- » Height: 12"
- » Base: 14"
- » Scupper: 8"
- » Soil Usage: 3 ft³
- » GPM: 7-10

48" Bowl OPT-48RPW

- » Size: 48"
- » Height: 16"
- » Base: 20"
- » Scupper: 8"
- » Soil Usage: 1 ft³
- » GPM: 7-10.



24" NATURAL GRAY

Cazo Water Bowl

Includes: Bowl, Copper Spillway, & Smooth Flow Water Fitting (1 ½" Inlet)

24" Bowl OPT-24RWO

- » Size: 24"
- » Height: 9"
- » Base: 9"
- » Scupper: 8"
- » GPM: 7-10

31" Bowl OPT-31RWO

- » Size: 31"
- » Height: 10"
- » Base: 10"
- » Scupper: 8"
- » GPM: 7-10

36" Bowl OPT-36RWO

- » Size: 36"
- » Height: 12"
- » Base: 14"
- » Scupper: 8"
- » GPM: 7-10

48" Bowl OPT-48RWO

- » Size: 48"
- » Height: 16"
- » Base: 20"
- » Scupper: 8"
- » GPM: 7-10



All Water Bowls Include The Easy Flow Fitting

All Water Bowls come with easy-flow water fitting that accommodates a 1 ½" water line



Key Valve Upgrade

OPT-KVI

Installed Onto Bowl: Key Valve, Installation Bracket, & Gas Hoses

Optional Cazo Canvas Cover

24" Cover - OPT-BCVR-24R
31" Cover - OPT-BCVR-32R
36" Cover - OPT-BCVR-36R
48" Cover - OPT-BCVR-48R

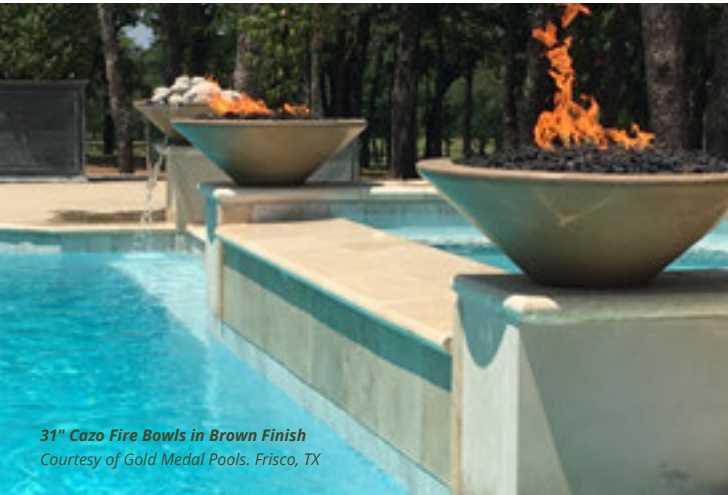

31" Cazo Fire Bowls in Brown Finish
Courtesy of Gold Medal Pools. Frisco, TX



31" Cazo Fire Bowls in Brown Finish — Courtesy of Horner Xpress

CAZO CONCRETE BOWLS



24" GRAY

Cazo Fire Bowl

Includes: Bowl, Fire Pan, Burner, Whistle Free Hose, Gas Orifice, Mounting Bracket, Lava Rock. (3" Opening)

24" Bowl OPT-24RFO OPT-24RFOE12V » Size: 24" » Height: 9" » Base: 9" » Burner: 8" » BTU: 45K » Sugg. Glass: 40 lbs.	31" Bowl OPT-31RFO OPT-31RFOE12V » Size: 31" » Height: 10" » Base: 10" » Burner: 12" » BTU: 65K » Sugg. Glass: 55lbs.	36" Bowl OPT-36RFO OPT-36RFOE12V » Size: 36" » Height: 12" » Base: 14" » Burner: 12" » BTU: 65K » Sugg. Glass: 95 lbs.	48" Bowl OPT-48RFO OPT-48RFOE12V » Size: 48" » Height: 16" » Base: 20" » Burner: 18" » BTU: 65K » Sugg. Glass: 200 lbs.
--	--	---	--



24" BLACK

Cazo Fire & Water Bowl

Includes: Bowl, Copper Scupper (¾" Inlet) Fire Pan, Burner, Whistle Free Hose, Gas Orifice, Mounting Bracket, Lava Rock. (3" Opening)

24" Bowl OPT-24RFW OPT-24RFWE12V » Size: 24" » Height: 9" » Base: 9" » Burner: 8" » BTU: 45K » Sugg. Glass: 40 lbs. » GPM: 7-10.	31" Bowl OPT-31RFW OPT-31RFWE12V » Size: 31" » Height: 10" » Base: 10" » Burner: 12" » BTU: 65K » Sugg. Glass: 55lbs. » GPM: 7-10.	36" Bowl OPT-36RFW OPT-36RFWE12V » Size: 36" » Height: 12" » Base: 14" » Burner: 12" » BTU: 65K » Sugg. Glass: 95 lbs. » GPM: 7-10.	48" Bowl OPT-48RFW OPT-48RFWE12V » Size: 48" » Height: 16" » Base: 20" » Burner: 18" » BTU: 65K » Sugg. Glass: 200 lbs. » GPM: 7-10.
--	--	---	--



48" GRAY

48" Cazo GFRC Fire & Water Bowl 360° Spill

Includes: Bowl, Fire Pan, Burner, Whistle Free Hose, Gas Orifice, Mounting Bracket, Lava Rock. (1 ½" Water Inlet)

OPT-48CZFW360
 OPT-48CZFW360E12V

- » Size: 48"
- » Height: 17"
- » Base: 20"
- » Burner: 8"
- » BTU: 65K
- » Sugg. Glass: 25 lbs.
- » GPM: 40

When ordering, specify the concrete color by adding the color code to the end of the Part #. Example: 27" Brown Sedona Water Bowl = OPT-27RWO-BRN
 Metallic Finishes and Rustic Finishes are available at an extra charge

Black -BLK	Ash -ASH	Natural Gray -NGY	Gray -GRY	White Limestone -LIM	Chocolate -CHC	Chestnut -CST	Brown -BRN	Vanilla -VAN
Rustic Gray -RGR	Moss Stone -RMS	Rustic White -RWH	Coffee -RCF	Slate -MSL	Silver -MSV	Pearl -MPR	Bronze -MBR	Copper -MCP

The Outdoor Plus individually handcrafts all products shown here. Finishes are subject to slight texture/color variations.

Proudly Made In The USA

Planter Bowl

Includes: Bowl Only
(Soil and plants not included.) (3" Opening)

27" Bowl OPT-27RP

- » Size: 27"
- » Height: 10"
- » Base: 12"
- » Soil Usage: 1.5 ft³

33" Bowl OPT-33RP

- » Size: 33"
- » Height: 11"
- » Base: 18"
- » Soil Usage: 2.5 ft³



27" CHOCOLATE

Planter & Water Bowl

Includes: Bowl, Copper Scupper (¾" Inlet) (3" Opening)
(Soil and plants not included)

27" Bowl OPT-27RPW

- » Size: 27"
- » Height: 10"
- » Base: 12"
- » Scupper: 8"
- » Soil Usage: 1.5 ft³
- » GPM: 7-10

33" Bowl OPT-33RPW

- » Size: 33"
- » Height: 11"
- » Base: 18"
- » Scupper: 8"
- » Soil Usage: 2.5 ft³
- » GPM: 7-10



27" BROWN



27" LIMESTONE

Sedona Water Bowl

Includes: Bowl, Copper Spillway, &
Smooth Flow Water Fitting (1 ½" Inlet)

27" Bowl OPT-27RWO

- » Size: 27"
- » Height: 10"
- » Base: 12"
- » Scupper: 8"
- » GPM: 7-10

33" Bowl OPT-33RWO

- » Size: 33"
- » Height: 11"
- » Base: 18"
- » Scupper: 8"
- » GPM: 7-10

Sedona Fire Bowl

Includes: Bowl, Fire Pan, Burner, Whistle Free Hose,
Gas Orifice, Mounting Bracket, Lava Rock. (3" Opening)

27" Bowl OPT-27RFO OPT-27RFOE12V

- » Size: 27"
- » Height: 10"
- » Base: 12"
- » Burner: 8"
- » BTU: 45K
- » Sugg. Glass: 50 lbs.

33" Bowl OPT-33RFO OPT-33RFOE12V

- » Size: 33"
- » Height: 11"
- » Base: 18"
- » Burner: 12"
- » BTU: 65K
- » Sugg. Glass: 75lbs.



33" Sedona Fire Bowls in Brown Finish — Courtesy of Watercrest Pools, N. Richland Hills, TX

SEDONA CONCRETE BOWLS



27" CHESTNUT

Sedona Fire & Water Bowl

Includes: Bowl, Copper Scupper (¾" Inlet) Fire Pan, Burner, Whistle Free Hose, Gas Orifice, Mounting Bracket, Lava Rock. (3" Opening)

27" Bowl
OPT-27RFW
OPT-27RFWE12V

- » Size: 27"
- » Height: 10"
- » Base: 12"
- » Burner: 8"
- » BTU: 45K
- » Sugg. Glass: 50 lbs.
- » GPM: 7-10

33" Bowl
OPT-33RFW
OPT-33RFWE12V

- » Size: 33"
- » Height: 11"
- » Base: 18"
- » Burner: 12"
- » BTU: 65K
- » Sugg. Glass: 75lbs.
- » GPM: 7-10



46" BLACK

Sedona Fire & Water Bowl – 4-Way Spill

Includes: Bowl, Fire Pan, Burner, Whistle Free Hose, Gas Orifice, Mounting Bracket, Lava Rock. (1 ½" Water Inlet)

46" Bowl
OPT-46RFW4W
OPT-46RFW4WE12V

- » Size: 46"
- » Height: 16"
- » Base: 24"
- » Burner: 18"
- » BTU: 65K
- » Sugg. Glass: 50 lbs.
- » GPM: 40

60" Bowl
OPT-60RFW4W
OPT-60RFW4WE12V

- » Size: 60"
- » Height: 15"
- » Base: 38"
- » Burner: 18"
- » BTU: 65K
- » Sugg. Glass: 50 lbs.
- » GPM: 40



38" GRAY

38" Sedona Fire & Water Bowl – 360° Spill

Includes: Bowl, Fire Pan, Burner, Whistle Free Hose, Gas Orifice, Mounting Bracket, Lava Rock. (1 ½" Water Inlet)

OPT-38FW360
OPT-38FW360E12V

- » Size: 38"
- » Height: 16"
- » Base: 18"
- » Burner: 8"
- » BTU: 45K
- » Sugg. Glass: 16lbs.
- » GPM: 40



All Water Bowls Include The Easy Flow Fitting

All Water Bowls come with easy-flow water fitting that accommodates a 1 ½" water line



Key Valve Upgrade

OPT-KVI

Installed Onto Bowl: Key Valve, Installation Bracket, & Gas Hoses

Optional Sedona Canvas Cover

27" Cover - OPT-BCVR-27R
33" Cover - OPT-BCVR-33R
38" Cover - OPT-BCVR-38R
48" Cover - OPT-BCVR-38R

LUNA CONCRETE BOWLS



30" LIMESTONE

Luna Planter Bowl

Includes: Bowl Only
(Soil and plants not included.) (3" Opening)

30" Bowl
OPT-LUNPO30

- » Size: 30"
- » Height: 15"
- » Base: 14"
- » Soil Usage: 3 ft³

38" Bowl
OPT-LUNPO38

- » Size: 38"
- » Height: 16"
- » Base: 20"
- » Soil Usage: 5.75 ft³



38" NATURAL GRAY

Luna Planter & Water Bowl

Includes: Bowl, Copper Scupper (¾" Inlet) (3" Opening)
(Soil and plants not included)

30" Bowl
OPT-LUNPW30

- » Size: 30"
- » Height: 15"
- » Base: 14"
- » Soil Usage: 3 ft³
- » Scupper: 8"
- » GPM: 7-10

38" Bowl
OPT-LUNPW38

- » Size: 38"
- » Height: 16"
- » Base: 20"
- » Soil Usage: 5.75 ft³
- » Scupper: 8"
- » GPM: 7-10



All Water Bowls Include The Easy Flow Fitting

All Water Bowls come with easy-flow water fitting that accommodates a 1 ½" water line



Key Valve Upgrade

OPT-KVI

Installed Onto Bowl: Key Valve, Installation Bracket, & Gas Hoses

Optional Luna Canvas Cover

30" Cover - OPT-BCVR-30R
38" Cover - OPT-BCVR-38R

LUNA CONCRETE BOWLS



30" LIMESTONE

Luna Water Bowl

Includes: Bowl, Copper Spillway, & Smooth Flow Water Fitting (1 1/2" Inlet)

30" Bowl

OPT-LUNWO30

- » Size: 30"
- » Height: 15"
- » Base: 14"
- » GPM: 7-10

38" Bowl

OPT-LUNWO38

- » Size: 38"
- » Height: 16"
- » Base: 22"
- » GPM: 7-10



30" BROWN

Luna Fire Bowl

Includes: Bowl, Fire Pan, Burner, Whistle Free Hose, Gas Orifice, Mounting Bracket, Lava Rock. (3" Opening)

30" Bowl

OPT-LUNFO30

OPT-LUNFO30E12V

- » Size: 30"
- » Height: 15"
- » Base: 14"
- » Burner: 8"
- » BTU: 45K
- » Sugg. Glass: 50lbs.

38" Bowl

OPT-LUNFO38

OPT-LUNFO38E12V

- » Size: 38"
- » Height: 16"
- » Base: 22"
- » Burner: 12"
- » BTU: 65K
- » Sugg. Glass: 100 lbs.



30" CHESTNUT

Luna Fire & Water Bowl

Includes: Bowl, Copper Scupper (3/4" Inlet) Fire Pan, Burner, Whistle Free Hose, Gas Orifice, Mounting Bracket, Lava Rock. (3" Opening)

30" Bowl

OPT-LUNFW30

OPT-LUNFW30E12V

- » Size: 30"
- » Height: 15"
- » Base: 14"
- » Burner: 8"
- » BTU: 45K
- » Sugg. Glass: 50lbs.
- » GPM: 7-10

38" Bowl

OPT-LUNFW38

OPT-LUNFW38E12V

- » Size: 38"
- » Height: 16"
- » Base: 22"
- » Burner: 12"
- » BTU: 65K
- » Sugg. Glass: 100 lbs.
- » GPM: 7-10

When ordering, specify the concrete color by adding the color code to the end of the Part #. Example: 27" Brown Sedona Water Bowl = OPT-27RWO-BRN
Metallic Finishes and Rustic Finishes are available at an extra charge

Black -BLK	Ash -ASH	Natural Gray -NGY	Gray -GRY	White Limestone -LIM	Chocolate -CHC	Chestnut -CST	Brown -BRN	Vanilla -VAN
Rustic Gray -RGR	Moss Stone -RMS	Rustic White -RWH	Coffee -RCF	Slate -MSL	Silver -MSV	Pearl -MPR	Bronze -MBR	Copper -MCP

The Outdoor Plus individually handcrafts all products shown here. Finishes are subject to slight texture/color variations.

Proudly Made In The USA



24" LIMESTONE

Maya Planter Bowl

Includes: Bowl Only (Soil and plants not included.) (3" Opening)

24" Bowl OPT-24SP

- » Size: 24"
- » Height: 10 ¾"
- » Base: 13"
- » Soil Usage: 1 ft³

30" Bowl OPT-30SP

- » Size: 30"
- » Height: 10 ¼"
- » Base: 13"
- » Soil Usage: 2 ft³

36" Bowl OPT-36SP

- » Size: 36"
- » Height: 12"
- » Base: 20"
- » Soil Usage: 2 ft³



24" CHESTNUT

Maya Planter & Water Bowl

Includes: Bowl, Copper Scupper (¾" Inlet) (3" Opening)
(Soil and plants not included)

24" Bowl OPT-24SPW

- » Size: 24"
- » Height: 10 ¾"
- » Base: 13"
- » Soil Usage: 1 ft³
- » Scupper: 8"
- » GPM: 7-10

30" Bowl OPT-30SPW

- » Size: 30"
- » Height: 10 ¼"
- » Base: 13"
- » Soil Usage: 2 ft³
- » Scupper: 8"
- » GPM: 7-10

36" Bowl OPT-36SPW

- » Size: 36"
- » Height: 12"
- » Base: 20"
- » Soil Usage: 2 ft³
- » Scupper: 12"
- » GPM: 7-10



30" BLACK

Maya Water Bowl

Includes: Bowl, Copper Spillway, &
Smooth Flow Water Fitting (1 ½" Inlet)

24" Bowl OPT-24SWO

- » Size: 24"
- » Height: 10 ¾"
- » Base: 13"
- » Scupper: 8"
- » GPM: 7-10

30" Bowl OPT-30SWO

- » Size: 30"
- » Height: 10 ¼"
- » Base: 13"
- » Scupper: 8"
- » GPM: 7-10

36" Bowl OPT-36SWO

- » Size: 36"
- » Height: 12"
- » Base: 20"
- » Scupper: 12"
- » GPM: 7-10



30" BROWN

Maya Fire Bowl

Includes: Bowl, Fire Pan, Burner, Whistle Free Hose, Gas
Orifice, Mounting Bracket, Lava Rock. (3" Opening)

24" Bowl OPT-24SFO OPT-24SFOE12V

- » Size: 24"
- » Height: 10 ¾"
- » Base: 13"
- » Burner: 8"
- » BTU: 45K
- » Sugg. Glass: 50 lbs.

30" Bowl OPT-30SFO OPT-30SFOE12V

- » Size: 30"
- » Height: 10 ¼"
- » Base: 13"
- » Burner: 8"
- » BTU: 45K
- » Sugg. Glass: 50 lbs.

36" Bowl OPT-36SFO OPT-36SFOE12V

- » Size: 36"
- » Height: 12"
- » Base: 20"
- » Burner: 12"
- » BTU: 65K
- » Sugg. Glass: 50 lbs.



All Water Bowls Include The Easy Flow Fitting

All Water Bowls come with easy-flow
water fitting that accommodates a 1
½" water line



Key Valve Upgrade

OPT-KVI

Installed Onto Bowl: Key Valve,
Installation Bracket, & Gas Hoses

Optional Maya Canvas Cover

24" Cover - OPT-BCVR-2424
30" Cover - OPT-BCVR-3030
36" Cover - OPT-BCVR-3636
48" x 20" Cover - OPT-CVR4820

MAYA CONCRETE BOWLS



30" NATURAL GRAY

Maya Fire & Water Bowl

Includes: Bowl, Copper Scupper (¾" Inlet) Fire Pan, Burner, Whistle Free Hose, Gas Orifice, Mounting Bracket, Lava Rock. (3" Opening)

24" Bowl
OPT-24SFV
OPT-24SFWE12V

- » Size: 24"
- » Height: 10.5"
- » Base: 13"
- » Burner: 8"
- » BTU: 45K
- » Sugg. Glass: 50 lbs.
- » Scupper: 8"
- » GPM: 7-10

30" Bowl
OPT-30SFV
OPT-30SFWE12V

- » Size: 30"
- » Height: 10 ¼"
- » Base: 13"
- » Burner: 8"
- » BTU: 45K
- » Sugg. Glass: 50 lbs.
- » Scupper: 8"
- » GPM: 7-10

36" Bowl
OPT-36SFV
OPT-36SFWE12V

- » Size: 36"
- » Height: 12"
- » Base: 20"
- » Burner: 12"
- » BTU: 65K
- » Sugg. Glass: 50 lbs.
- » Scupper: 10"
- » GPM: 7-10



30" BROWN

Maya Fire & Wide Spill Water Bowl

Includes: Bowl, Copper Scupper (¾" Inlet) Fire Pan, Burner, Whistle Free Hose, Gas Orifice, Mounting Bracket, Lava Rock. (3" Opening)

24" Bowl
OPT-24SFVWS
OPT-24SFVWSE12V

- » Size: 24"
- » Height: 10 ¾"
- » Base: 13"
- » Burner: 8"
- » BTU: 45K
- » Sugg. Glass: 50 lbs.
- » Scupper: 16"
- » GPM: 15

30" Bowl
OPT-30SFVWS
OPT-30SFVWSE12V

- » Size: 30"
- » Height: 10 ¼"
- » Base: 13"
- » Burner: 8"
- » BTU: 45K
- » Sugg. Glass: 50 lbs.
- » Scupper: 16"
- » GPM: 15

36" Bowl
OPT-36SFVWS
OPT-36SFVWSE12V

- » Size: 36"
- » Height: 12"
- » Base: 20"
- » Burner: 12"
- » BTU: 65K
- » Sugg. Glass: 50 lbs.
- » Scupper: 20"
- » GPM: 15



48" LIMESTONE

Linear Maya Fire Bowl

Includes: Bowl, Fire Pan, Burner, Whistle Free Hose, Gas Orifice, Lava Rock.

48" Bowl
OPT-4820MFO
OPT-4820MFOE12V

- » Size: 48" x 20"
- » Height: 12"
- » Base: 38" x 10"
- » Burner: 30" Linear
- » BTU: 50K
- » Sugg. Glass: 60 lbs.



48" LIMESTONE

Linear Maya Fire & Water

Includes: Bowl, Copper Scupper (¾" Inlet) Fire Pan, Burner, Whistle Free Hose, Gas Orifice, Lava Rock.

48" Bowl
OPT-4820MFW
OPT-4820MFW12V

- » Size: 48" x 20"
- » Height: 12"
- » Base: 38" x 10"
- » Burner: 30" Linear
- » BTU: 50K
- » Sugg. Glass: 60 lbs.
- » Scupper 36"
- » GPM: 20



24" BLACK

Avalon Planter Bowl

Includes: Bowl Only
(Soil and plants not included.) (3" Opening)

24" Bowl
OPT-AVLPO24

- » Size: 24"
- » Height: 10"
- » Base: 13"
- » Soil Usage: 1 ft³

30" Bowl
OPT-AVLPO30

- » Size: 30"
- » Height: 12"
- » Base: 18"
- » Soil Usage: 2 ft³

36" Bowl
OPT-AVLPO36

- » Size: 36"
- » Height: 12"
- » Base: 20"
- » Soil Usage: 2 ft³



24" LIMESTONE

Avalon Planter & Water Bowl

Includes: Bowl, Copper Scupper (¾" Inlet) (3" Opening)
(Soil and plants not included)

24" Bowl
OPT-AVLPW24

- » Size: 24"
- » Height: 10"
- » Base: 13"
- » Soil Usage: 1 ft³
- » Scupper: 8"
- » GPM: 7-10

30" Bowl
OPT-AVLPW30

- » Size: 30"
- » Height: 12"
- » Base: 18"
- » Soil Usage: 2 ft³
- » Scupper: 8"
- » GPM: 7-10

36" Bowl
OPT-AVLPW36

- » Size: 36"
- » Height: 12"
- » Base: 20"
- » Soil Usage: 2 ft³
- » Scupper: 12"
- » GPM: 7-10



24" BROWN

Avalon Water Bowl

Includes: Bowl, Copper Spillway, &
Smooth Flow Water Fitting (1 ½" Inlet)

24" Bowl
OPT-AVLWO24

- » Size: 24"
- » Height: 10"
- » Base: 13"
- » Scupper: 8"
- » GPM: 7-10

30" Bowl
OPT-AVLWO30

- » Size: 30"
- » Height: 12"
- » Base: 18"
- » Scupper: 8"
- » GPM: 7-10

36" Bowl
OPT-AVLWO36

- » Size: 36"
- » Height: 12"
- » Base: 20"
- » Scupper: 10"
- » GPM: 7-10



All Water Bowls Include The Easy Flow Fitting

All Water Bowls come with easy-flow water fitting that accommodates a 1 ½" water line



Key Valve Upgrade

OPT-KVI

Installed Onto Bowl: Key Valve, Installation Bracket, & Gas Hoses

Optional Avalon Canvas Cover

24" Cover - OPT-BCVR-2424
30" Cover - OPT-BCVR-3030
36" Cover - OPT-BCVR-3636

AVALON CONCRETE BOWLS



30" NATURAL GRAY

Avalon Fire Bowl

Includes: Bowl, Fire Pan, Burner, Whistle Free Hose, Gas Orifice, Mounting Bracket, Lava Rock. (3" Opening)

24" Bowl

OPT-AVLFO24
OPT-AVLFO24E12V

- » Size: 24"
- » Height: 10"
- » Base: 13"
- » Burner: 8"
- » BTU: 45K
- » Sugg. Glass: 40 lbs.

30" Bowl

OPT-AVLFO30
OPT-AVLFO30E12V

- » Size: 30"
- » Height: 12"
- » Base: 18"
- » Burner: 8"
- » BTU: 45K
- » Sugg. Glass: 55 lbs.

36" Bowl

OPT-AVLFO36
OPT-AVLFO36E12V

- » Size: 36"
- » Height: 12"
- » Base: 20"
- » Burner: 12"
- » BTU: 65K
- » Sugg. Glass: 95 lbs.



30" LIMESTONE

Avalon Fire & Water Bowl

Includes: Bowl, Copper Scupper (¾" Inlet) Fire Pan, Burner, Whistle Free Hose, Gas Orifice, Mounting Bracket, Lava Rock. (3" Opening)

24" Bowl

OPT-AVLFW24
OPT-AVLFW24E12V

- » Size: 24"
- » Height: 10"
- » Base: 13"
- » Burner: 8"
- » BTU: 45K
- » Sugg. Glass: 40 lbs.
- » Scupper: 8"
- » GPM: 7-10

30" Bowl

OPT-AVLFW30
OPT-AVLFW30E12V

- » Size: 30"
- » Height: 12"
- » Base: 18"
- » Burner: 12"
- » BTU: 65K
- » Sugg. Glass: 55 lbs.
- » Scupper: 8"
- » GPM: 7-10

36" Bowl

OPT-AVLFW36
OPT-AVLFW36E12V

- » Size: 36"
- » Height: 12"
- » Base: 20"
- » Burner: 12"
- » BTU: 65K
- » Sugg. Glass: 95 lbs.
- » Scupper: 10"
- » GPM: 7-10

When ordering, specify the concrete color by adding the color code to the end of the Part #. Example: 27" Brown Sedona Water Bowl = OPT-27RWO-BRN
Metallic Finishes and Rustic Finishes are available at an extra charge

Black -BLK	Ash -ASH	Natural Gray -NGY	Gray -GRY	White Limestone -LIM	Chocolate -CHC	Chestnut -CST	Brown -BRN	Vanilla -VAN
Rustic Gray -RGR	Moss Stone -RMS	Rustic White -RWH	Coffee -RCF	Slate -MSL	Silver -MSV	Pearl -MPR	Bronze -MBR	Copper -MCP

The Outdoor Plus individually handcrafts all products shown here. Finishes are subject to slight texture/color variations.

Proudly Made In The USA



24" VANILLA

Roma Planter Bowl

Includes: Bowl Only
(Soil and plants not included.) (3" Opening)

24" Bowl
OPT-ROMPO24

- » Size: 24"
- » Height: 10"
- » Base: 9"
- » Soil Usage: 1 ft³

36" Bowl
OPT-ROMPO36

- » Size: 36"
- » Height: 16"
- » Base: 18"
- » Soil Usage: 2 ft³

Roma Planter & Water Bowl

Includes: Bowl, Copper Scupper (¾" Inlet) (14" Opening)
(Soil and plants not included)

24" Bowl
OPT-ROMPW24

- » Size: 24"
- » Height: 10"
- » Base: 9"
- » Soil Usage: 1 ft³
- » Scupper: 8"
- » GPM: 7-10

36" Bowl
OPT-ROMPW36

- » Size: 36"
- » Height: 16"
- » Base: 18"
- » Soil Usage: 2 ft³
- » Scupper: 8"
- » GPM: 7-10



36" CHOCOLATE

Roma Water Bowl

Includes: Bowl, Copper Spillway, &
Smooth Flow Water Fitting (1 ½" Inlet)

24" Bowl
OPT-ROMWO24

- » Size: 24"
- » Height: 10"
- » Base: 9"
- » Scupper: 8"
- » GPM: 7-10

36" Bowl
OPT-ROMWO36

- » Size: 36"
- » Height: 16"
- » Base: 18"
- » Scupper: 8"
- » GPM: 7-10



All Water Bowls Include The Easy Flow Fitting

All Water Bowls come with easy-flow water fitting that accommodates a 1 ½" water line



Key Valve Upgrade

OPT-KVI

Installed Onto Bowl: Key Valve, Installation Bracket, & Gas Hoses

Optional Roma Canvas Cover

24" Cover - OPT-BCVR-24R
37" Cover - OPT-BCVR-37R

ROMA CONCRETE BOWLS



36" BROWN

Roma Fire Bowl

Includes: Bowl, Fire Pan, Burner, Whistle Free Hose, Gas Orifice, Mounting Bracket, Lava Rock. (14" Opening)

24" Bowl

OPT-ROMFO24
OPT-ROMFO24E12V

- » Size: 24"
- » Height: 10"
- » Base: 9"
- » Burner: 8"
- » BTU: 45K
- » Sugg. Glass: 40 lbs.

36" Bowl

OPT-ROMFO36
OPT-ROMFO36E12V

- » Size: 36"
- » Height: 16"
- » Base: 18"
- » Burner: 12"
- » BTU: 45K
- » Sugg. Glass: 55 lbs.



36" NATURAL
GRAY

Roma Fire & Water Bowl

Includes: Bowl, Copper Scupper (3/4" Inlet) Fire Pan, Burner, Whistle Free Hose, Gas Orifice, Mounting Bracket, Lava Rock. (14" Opening)

24" Bowl

OPT-ROMFW24
OPT-ROMFW24E12V

- » Size: 24"
- » Height: 10"
- » Base: 9"
- » Burner: 8"
- » BTU: 45K
- » Sugg. Glass: 40 lbs.
- » Scupper: 8"
- » GPM: 7-10

36" Bowl

OPT-ROMFW36
OPT-ROMFW36E12V

- » Size: 36"
- » Height: 16"
- » Base: 18"
- » Burner: 12"
- » BTU: 65K
- » Sugg. Glass: 55 lbs.
- » Scupper: 8"
- » GPM: 7-10

When ordering, specify the concrete color by adding the color code to the end of the Part #. Example: 27" Brown Sedona Water Bowl = OPT-27RWO-BRN
Metallic Finishes and Rustic Finishes are available at an extra charge

Black -BLK	Ash -ASH	Natural Gray -NGY	Gray -GRY	White Limestone -LIM	Chocolate -CHC	Chestnut -CST	Brown -BRN	Vanilla -VAN
Rustic Gray -RGR	Moss Stone -RMS	Rustic White -RWH	Coffee -RCF	Slate -MSL	Silver -MSV	Pearl -MPR	Bronze -MBR	Copper -MCP

The Outdoor Plus individually handcrafts all products shown here. Finishes are subject to slight texture/color variations.

Proudly Made In The USA

Sedona Water Bowl

Includes: Bowl, Copper Spillway, & Smooth Flow Water Fitting (1 1/2" Inlet)

27" Bowl

OPT-27RWGWO

- » Size: 27"
- » Height: 10"
- » Base: 12"
- » Scupper: 8"
- » GPM: 7-10

Sedona Planter Bowl

Includes: Bowl Only
(Soil and plants not included.) (3" Opening)

27" Bowl

OPT-27RWGWO

- » Size: 27"
- » Height: 10"
- » Base: 12"
- » Soil Usage: 1.5 ft³

Sedona Planter & Water Bowl

Includes: Bowl, Copper Scupper (3/4" Inlet) (3" Opening)
(Soil and plants not included)

27" Bowl

OPT-27RWGWP

- » Size: 27"
- » Height: 10"
- » Base: 12"
- » Soil Usage: 1.5 ft³
- » Scupper: 8"
- » GPM: 7-10



27" OAK

The Outdoor Plus individually handcrafts all products shown here. Finishes are subject to slight texture/color variations.



27" Sedona Planter & Water Bowl in Ivory Wood Grain Finish

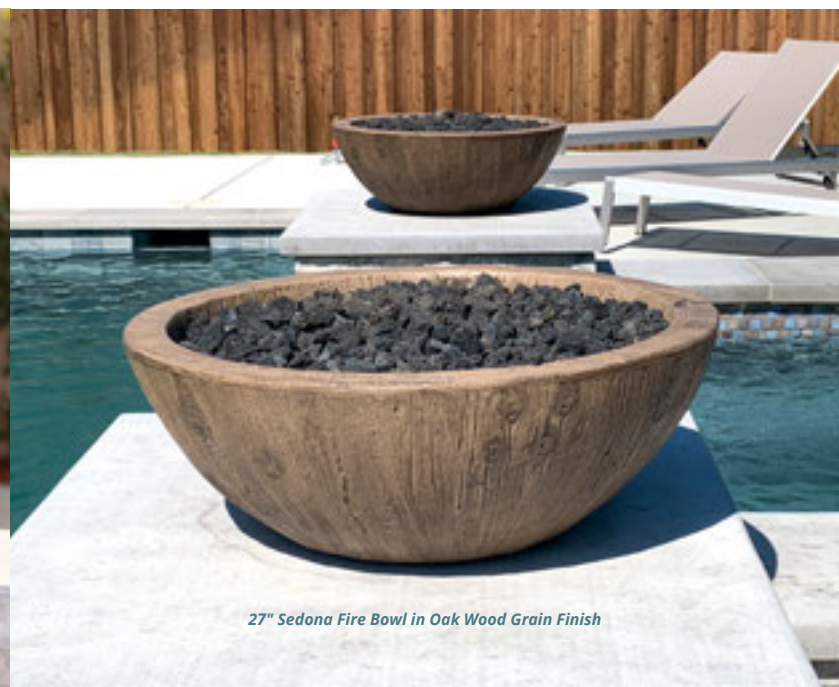

27" Sedona Fire Bowl in Oak Wood Grain Finish

SEDONA BOWLS - WOOD GRAIN CONCRETE

Sedona Fire Bowl

Includes: Bowl, Fire Pan, Burner, Whistle Free Hose, Gas Orifice, Mounting Bracket, Lava Rock. (3" Opening)

27" Bowl

OPT-27RWGFO
OPT-27RWGFOE12V

- » Size: 27"
- » Height: 10"
- » Base: 12"
- » Burner: 8"
- » BTU: 45K
- » Sugg. Glass: 20 lbs.



27" IVORY

Sedona Fire & Water Bowl

Includes: Bowl, Copper Scupper (¾" Inlet) Fire Pan, Burner, Whistle Free Hose, Gas Orifice, Mounting Bracket, Lava Rock. (3" Opening)

27" Bowl

OPT-27RWGFW
OPT-27RWGFW12V

- » Size: 27"
- » Height: 10"
- » Base: 12"
- » Burner: 8"
- » BTU: 45K
- » Sugg. Glass: 20 lbs.
- » Scupper: 8"
- » GPM: 7-10



27" EBONY



GFRC WOOD GRAIN COLOR OPTIONS

When ordering, specify the color by adding the color code to the end of the Part #.
Example: Coronado Fire Pit in Ivory = OPT-COR48-IVY



All Water Bowls Include The Easy Flow Fitting

All Water Bowls come with easy-flow water fitting that accommodates a 1 ½" water line



Key Valve Upgrade
OPT-KVI

Installed Onto Bowl: Key Valve, Installation Bracket, & Gas Hoses

Optional Sedona Canvas Cover
27" Cover - OPT-BCVR-27R

Maya Planter Bowl

Includes: Bowl Only
(Soil and plants not included.) (3" Opening)

24" Bowl
OPT-24SWGPO

- » Size: 24"
- » Height: 10.5"
- » Base: 13"
- » Soil Usage: 1.5 ft³

30" Bowl
OPT-30SWGPO

- » Size: 30"
- » Height: 10.5"
- » Base: 13"
- » Soil Usage: 2 ft³



30" OAK

Maya Planter & Water Bowl

Includes: Bowl, Copper Scupper (¾" Inlet) (3" Opening)
(Soil and plants not included)

24" Bowl
OPT-24SWGPPW

- » Size: 24"
- » Height: 10.5"
- » Base: 13"
- » Soil Usage: 1.5 ft³
- » Scupper: 8"
- » GPM: 7-10

30" Bowl
OPT-30SWGPPW

- » Size: 30"
- » Height: 10.5"
- » Base: 13"
- » Soil Usage: 2 ft³
- » Scupper: 8"
- » GPM: 7-10

Maya Water Bowl

Includes: Bowl, Copper Spillway, &
Smooth Flow Water Fitting (1 ½" Inlet)

24" Bowl
OPT-24SWGWO

- » Size: 24"
- » Height: 10.5"
- » Base: 13"
- » Scupper: 8"
- » GPM: 7-10

30" Bowl
OPT-30SWGWO

- » Size: 30"
- » Height: 10.5"
- » Base: 13"
- » Scupper: 8"
- » GPM: 7-10



30" OAK

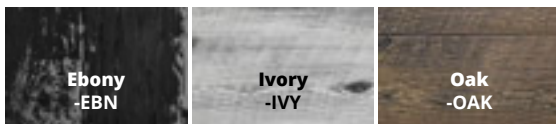

GFRC WOOD GRAIN COLOR OPTIONS

When ordering, specify the color by adding the color code to the end of the Part #.
Example: Coronado Fire Pit in Ivory = OPT-COR48-IVY

MAYA BOWLS - WOOD GRAIN CONCRETE

Maya Fire Bowl

Includes: Bowl, Fire Pan, Burner, Whistle Free Hose, Gas Orifice, Mounting Bracket, Lava Rock. (3" Opening)

24" Bowl

OPT-24SWGFO
OPT-24SWGFOE12V

- » Size: 24"
- » Height: 10.5"
- » Base: 13"
- » Burner: 8"
- » BTU: 45K
- » Sugg. Glass: 20 lbs.

30" Bowl

OPT-30SWGFO
OPT-30SWGFOE12V

- » Size: 30"
- » Height: 10.5"
- » Base: 13"
- » Burner: 8"
- » BTU: 45K
- » Sugg. Glass: 20 lbs.



30" EBONY

Maya Fire & Water Bowl

Includes: Bowl, Copper Scupper (3/4" Inlet) Fire Pan, Burner, Whistle Free Hose, Gas Orifice, Mounting Bracket, Lava Rock. (3" Opening)

24" Bowl

OPT-24SWGFW
OPT-24SWGFWWE12V

- » Size: 24"
- » Height: 10.5"
- » Base: 13"
- » Burner: 8"
- » BTU: 45K
- » Sugg. Glass: 20 lbs.
- » Scupper: 8"
- » GPM: 7-10

30" Bowl

OPT-30SWGFW
OPT-30SWGFWWE12V

- » Size: 30"
- » Height: 10.5"
- » Base: 13"
- » Burner: 8"
- » BTU: 45K
- » Sugg. Glass: 20 lbs.
- » Scupper: 8"
- » GPM: 7-10



30" IVORY

Maya Fire & Wide Spill Water Bowl

Includes: Bowl, Copper Scupper (3/4" Inlet) Fire Pan, Burner, Whistle Free Hose, Gas Orifice, Mounting Bracket, Lava Rock. (3" Opening)

24" Bowl

OPT-24SWGFWWS
OPT-24SWGFWWSE12V

- » Size: 24"
- » Height: 10.5"
- » Base: 13"
- » Burner: 8"
- » BTU: 45K
- » Sugg. Glass: 20 lbs.
- » Scupper: 8"
- » GPM: 15

30" Bowl

OPT-30SWGFWWS
OPT-30SWGFWWSE12V

- » Size: 30"
- » Height: 10.5"
- » Base: 13"
- » Burner: 8"
- » BTU: 45K
- » Sugg. Glass: 20 lbs.
- » Scupper: 8"
- » GPM: 15



24" IVORY



All Water Bowls Include The Easy Flow Fitting

All Water Bowls come with easy-flow water fitting that accommodates a 1 1/2" water line



Key Valve Upgrade

OPT-KVI

Installed Onto Bowl: Key Valve, Installation Bracket, & Gas Hoses

Optional Maya Canvas Cover

24" Cover - OPT-BCVR-2424
30" Cover - OPT-BCVR-3030

Cazo Planter Bowl

Includes: Bowl Only
(Soil and plants not included.) (3" Opening)

24" Bowl

OPT-24RWGPO

- » Size: 24"
- » Height: 8"
- » Base: 12"
- » Soil Usage: 1.5 ft³

32" Bowl

OPT-32RWGPO

- » Size: 32"
- » Height: 11"
- » Base: 12"
- » Soil Usage: 2 ft³



32" EBONY

Cazo Planter & Water Bowl

Includes: Bowl, Copper Scupper (¾" Inlet) (3" Opening)
(Soil and plants not included)

24" Bowl

OPT-24RWGPW

- » Size: 24"
- » Height: 8"
- » Base: 12"
- » Soil Usage: 1.5 ft³
- » Scupper: 8"
- » GPM: 7-10

32" Bowl

OPT-32RWGPW

- » Size: 32"
- » Height: 11"
- » Base: 12"
- » Soil Usage: 2 ft³
- » Scupper: 8"
- » GPM: 7-10

Cazo Water Bowl

Includes: Bowl, Copper Spillway, &
Smooth Flow Water Fitting (1 ½" Inlet)

24" Bowl

OPT-24RWGWO

- » Size: 24"
- » Height: 8"
- » Base: 12"
- » Scupper: 8"
- » GPM: 7-10

32" Bowl

OPT-32RWGWO

- » Size: 32"
- » Height: 10"
- » Base: 12"
- » Scupper: 8"
- » GPM: 7-10



32" IVORY



GFRC WOOD GRAIN COLOR OPTIONS

When ordering, specify the color by adding the color code to the end of the Part #.
Example: Coronado Fire Pit in Ivory = OPT-COR48-IVY

CAZO BOWLS - WOOD GRAIN CONCRETE

Cazo Fire Bowl

Includes: Bowl, Fire Pan, Burner, Whistle Free Hose, Gas Orifice, Mounting Bracket, Lava Rock. (3" Opening)

24" Bowl

OPT-24RWGFO
OPT-24RWGFOE12V

- » Size: 24"
- » Height: 8"
- » Base: 12"
- » Burner: 8"
- » BTU: 45K
- » Sugg. Glass: 20 lbs.

32" Bowl

OPT-32RWGFO
OPT-32RWGFOE12V

- » Size: 32"
- » Height: 10"
- » Base: 12"
- » Burner: 8"
- » BTU: 45K
- » Sugg. Glass: 20 lbs.



32" OAK

Cazo Fire & Water Bowl

Includes: Bowl, Copper Scupper (¾" Inlet) Fire Pan, Burner, Whistle Free Hose, Gas Orifice, Mounting Bracket, Lava Rock. (3" Opening)

24" Bowl

OPT-24RWGFW
OPT-24RWGFWWE12V

- » Size: 24"
- » Height: 8"
- » Base: 12"
- » Burner: 8"
- » BTU: 45K
- » Sugg. Glass: 20 lbs.
- » Scupper: 8"
- » GPM: 7-10

32" Bowl

OPT-32RWGFW
OPT-32RWGFWWE12V

- » Size: 32"
- » Height: 10"
- » Base: 12"
- » Burner: 8"
- » BTU: 45K
- » Sugg. Glass: 20 lbs.
- » Scupper: 8"
- » GPM: 7-10



32" EBONY



All Water Bowls Include The Easy Flow Fitting

All Water Bowls come with easy-flow water fitting that accommodates a 1 ½" water line



Key Valve Upgrade

OPT-KVI

Installed Onto Bowl: Key Valve, Installation Bracket, & Gas Hoses

Optional Cazo Canvas Cover

24" Cover - OPT-BCVR-24R
32" Cover - OPT-BCVR-32R

Cazo Planter Bowl

Includes: Bowl Only
(Soil and plants not included.) (3" Opening)



24" Bowl
OPT-R24CPO

- » Size: 24"
- » Height: 10"
- » Base: 10"
- » Soil Usage: 1.25 ft³

30" Bowl
OPT-R30CPO

- » Size: 30"
- » Height: 12"
- » Base: 15"
- » Soil Usage: 3 ft³

36" Bowl
OPT-R36CPO

- » Size: 36"
- » Height: 12"
- » Base: 15"
- » Soil Usage: 4.5 ft³

Cazo Planter & Water Bowl

Includes: Bowl, Copper Scupper (¾" Inlet) (3" Opening)
(Soil and plants not included)

24" Bowl
OPT-R24CPW

- » Size: 24"
- » Height: 10"
- » Base: 10"
- » Soil Usage: 1.25 ft³
- » Scupper: 8"
- » GPM: 7-10

30" Bowl
OPT-R30CPW

- » Size: 30"
- » Height: 12"
- » Base: 15"
- » Soil Usage: 3 ft³
- » Scupper: 8"
- » GPM: 7-10

36" Bowl
OPT-R36CPW

- » Size: 36"
- » Height: 12"
- » Base: 15"
- » Soil Usage: 4.5 ft³
- » Scupper: 10"
- » GPM: 10

Cazo Water Bowl

Includes: Bowl, Copper Spillway
(1 ½" Water Inlet)



24" Bowl
OPT-R24CPWO

- » Size: 24"
- » Height: 10"
- » Base: 10"
- » Scupper: 8"
- » GPM: 7-10

30" Bowl
OPT-R30CPWO

- » Size: 30"
- » Height: 12"
- » Base: 15"
- » Scupper: 8"
- » GPM: 7-10

36" Bowl
OPT-R36CPWO

- » Size: 36"
- » Height: 12"
- » Base: 15"
- » Scupper: 12"
- » GPM: 10

Cazo Fire Bowl

Includes: Bowl, Fire Pan, Burner, Whistle Free Hose, Gas Orifice,
Mounting Bracket, Lava Rock. (3" Opening)



24" Bowl
OPT-101-24NWF
OPT-101-24NWF12V

- » Size: 24"
- » Height: 10"
- » Base: 10"
- » Burner: 8"
- » BTU: 45K
- » Sugg. Glass: 20 lbs.

30" Bowl
OPT-102-30NWF
OPT-102-30NWF12V

- » Size: 30"
- » Height: 12"
- » Base: 15"
- » Burner: 8"
- » BTU: 45K
- » Sugg. Glass: 35 lbs.

36" Bowl
OPT-102-36NWF
OPT-102-36NWF12V

- » Size: 36"
- » Height: 12"
- » Base: 15"
- » Burner: 12"
- » BTU: 65K
- » Sugg. Glass: 50 lbs.



All Water Bowls Include The Easy Flow Fitting

All Water Bowls come with easy-flow water fitting that accommodates a 1 ½" water line



Key Valve Upgrade

OPT-KVI

Installed Onto Bowl: Key Valve, Installation Bracket, & Gas Hoses

Optional Cazo Canvas Cover

24" Cover - OPT-BCVR-24R
30" Cover - OPT-BCVR-30R
36" Cover - OPT-BCVR-36R

CAZO COPPER BOWL



Cazo Fire & Water Bowl

Includes: Bowl, Copper Scupper (¾" Inlet) Fire Pan, Burner, Whistle Free Hose, Gas Orifice, Mounting Bracket, Lava Rock. (3" Opening)

24" Bowl

OPT-101-24NWCB
OPT-101-24NWCBE12V

- » Size: 24"
- » Height: 10"
- » Base: 10"
- » Burner: 8"
- » BTU: 45K
- » Sugg. Glass: 20 lbs.
- » Scupper: 8"
- » GPM: 7-10

30" Bowl

OPT-102-30NWCB
OPT-102-30NWCBE12V

- » Size: 30"
- » Height: 12"
- » Base: 15"
- » Burner: 8"
- » BTU: 45K
- » Sugg. Glass: 35 lbs.
- » Scupper: 8"
- » GPM: 7-10

36" Bowl

OPT-102-36NWCB
OPT-102-36NWCBE12V

- » Size: 36"
- » Height: 12"
- » Base: 15"
- » Burner: 12"
- » BTU: 65K
- » Sugg. Glass: 50 lbs.
- » Scupper: 8"
- » GPM: 7-10



Cazo Fire & Water Bowl, 4-Way Spill

Includes: Bowl, Fire Pan, Burner, Whistle Free Hose, Gas Orifice, Lava Rock. (1 ½" Water Inlet)

30" Bowl

OPT-4W30
OPT-4W30E12V

- » Size: 30"
- » Height: 12"
- » Base: 16"
- » Burner: 12"
- » BTU: 65K
- » Sugg. Glass: 40 lbs.
- » Scupper: 8"
- » GPM: 30
- » Water Inlet: 1 ½"

36" Bowl

OPT-4W36
OPT-4W36E12V

- » Size: 36"
- » Height: 12"
- » Base: 20"
- » Burner: 12"
- » BTU: 65K
- » Sugg. Glass: 55 lbs.
- » Scupper: 8"
- » GPM: 30
- » Water Inlet: 1 ½"

Cazo Fire & Water Bowl- 360° Spill

Includes: Bowl, Fire Pan, Burner, Whistle Free Hose, Gas Orifice, Lava Rock. (1 ½" Water Inlet)

30" Bowl

OPT-30FW360
OPT-30FW360E12V

- » Size: 30"
- » Height: 13.5"
- » Base: 16"
- » Burner: 6"
- » BTU: 45K
- » Sugg. Glass: 35 lbs.
- » GPM: 15
- » Water Inlet: 1 ½"

36" Bowl

OPT-36FW360
OPT-36FW360E12V

- » Size: 36"
- » Height: 13.5"
- » Base: 20"
- » Burner: 8"
- » BTU: 45K
- » Sugg. Glass: 35 lbs.
- » GPM: 15
- » Water Inlet: 1 ½"



30" Cazo Fire & Water Bowl, 4-Way Spill - OPT-4W30
Courtesy of Pool Logic Design & Construction, CA

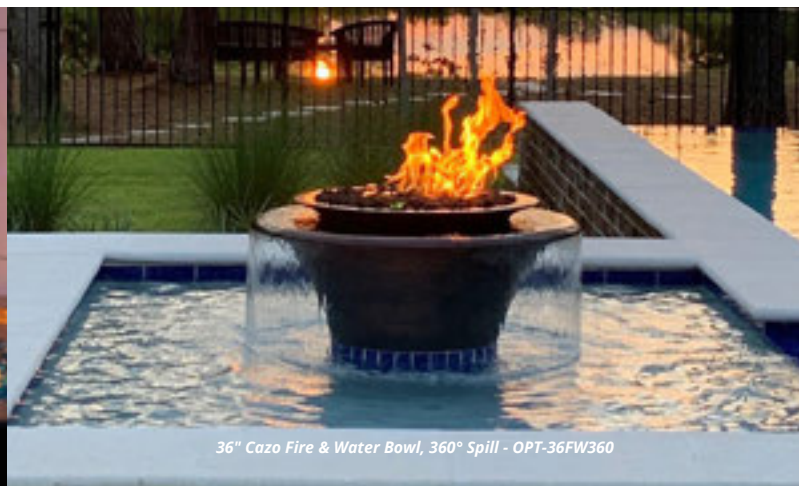

36" Cazo Fire & Water Bowl, 360° Spill - OPT-36FW360



Sedona Planter Bowl

Includes: Bowl Only
(Soil and plants not included.) (3" Opening)

27" Bowl
OPT-27RCRPO

- » Size: 27"
- » Height: 10"
- » Base: 12"
- » Soil Usage: 1.5 ft³

Sedona Planter & Water Bowl

Includes: Bowl, Copper Scupper (¾" Inlet) (3" Opening)
(Soil and plants not included)

27" Bowl
OPT-27RCRPW

- » Size: 27"
- » Height: 10"
- » Base: 12"
- » Soil Usage: 1.5 ft³
- » Scupper: 8"
- » GPM: 7-10



Sedona Water Bowl

Includes: Bowl, Copper Spillway
(1 ½" Water Inlet)

27" Bowl
OPT-27RCRWO

- » Size: 27"
- » Height: 10"
- » Base: 12"
- » Scupper: 8"
- » GPM: 7-10



Sedona Fire Bowl

Includes: Bowl, Fire Pan, Burner, Whistle Free Hose,
Gas Orifice, Mounting Bracket, Lava Rock. (3" Opening)

27" Bowl
OPT-27RCPRFO
OPT-27RCPRFOE12V

- » Size: 27"
- » Height: 10"
- » Base: 12"
- » Burner: 8"
- » BTU: 45K
- » Sugg. Glass: 20 lbs.



All Water Bowls Include The Easy Flow Fitting

All Water Bowls come with easy-flow
water fitting that accommodates a 1 ½"
water line



Key Valve Upgrade

OPT-KVI

Installed Onto Bowl: Key Valve,
Installation Bracket, & Gas Hoses

Optional Sedona Canvas Cover

27" Cover - OPT-BCVR-27R

SEDONA COPPER BOWL



Sedona Fire & Water Bowl

Includes: Bowl, Copper Scupper (¾" Inlet) Fire Pan, Burner, Whistle Free Hose, Gas Orifice, Mounting Bracket, Lava Rock. (3" Opening)

27" Bowl

OPT-27RCPRFW
OPT-27RCPRFWE12V

- » Size: 27"
- » Height: 10"
- » Base: 12"
- » Burner: 8"
- » BTU: 45K
- » Sugg. Glass: 20 lbs.
- » Scupper: 8"
- » GPM: 7-10



Sedona Fire & Water Bowl - Gravity Spill

Includes: Bowl, Copper Scupper (¾" Inlet) Fire Pan, Burner, Whistle Free Hose, Gas Orifice, Mounting Bracket, Lava Rock. (3" Opening)

27" Bowl

OPT-27RCPRFWGS
OPT-27RCPRFWGSE12V

- » Size: 27"
- » Height: 10"
- » Base: 12"
- » Burner: 8"
- » BTU: 45K
- » Sugg. Glass: 20 lbs.
- » Scupper: 8"
- » GPM: 7-10



27" Sedona Copper Fire Bowl

Maya Planter Bowl

Includes: Bowl Only
(Soil and plants not included.)

24" Bowl
OPT-24SCPO

Size: 24"
Height: 10"
Base: 12"
Soil Usage: 2 ft³

30" Bowl
OPT-30SCPO

Size: 30"
Height: 10"
Base: 15"
Soil Usage: 3 ft³

36" Bowl
OPT-36SCPO

Size: 36"
Height: 12"
Base: 18"
Soil Usage: 5.25 ft³



Maya Planter & Water Bowl

Includes: Bowl, Copper Scupper (¾" Inlet)
(Soil and plants not included)

24" Bowl
OPT-24SCPW

Size: 24"
Height: 10"
Base: 12"
Soil Usage: 2 ft³
Scupper: 8"
GPM: 7-10

30" Bowl
OPT-30SCPW

Size: 30"
Height: 10"
Base: 15"
Soil Usage: 3 ft³
Scupper: 8"
GPM: 7-10

36" Bowl
OPT-36SCPW

Size: 36"
Height: 12"
Base: 18"
Soil Usage: 5.25 ft³
Scupper: 10"
GPM: 7-10

Maya Water Bowl

Includes: Bowl, Copper Spillway
(1 ½" Water Inlet)

24" Bowl
OPT-24SCW

Size: 24"
Height: 10"
Base: 12"
Scupper: 8"
GPM: 7-10

30" Bowl
OPT-30SCW

Size: 30"
Height: 10"
Base: 15"
Scupper: 8"
GPM: 7-10

36" Bowl
OPT-36SCW

Size: 36"
Height: 12"
Base: 18"
Scupper: 10"
GPM: 7-10



Maya Water Bowl - Wide Spill

Includes: Bowl, Copper Spillway
(1 ½" Water Inlet)

24" Bowl
OPT-24SCXW

Size: 24"
Height: 10"
Base: 12"
Scupper: 20"
GPM: 15

30" Bowl
OPT-30SCXW

Size: 30"
Height: 10"
Base: 15"
Scupper: 24"
GPM: 15

36" Bowl
OPT-36SCXW

Size: 36"
Height: 12"
Base: 18"
Scupper: 30"
GPM: 15

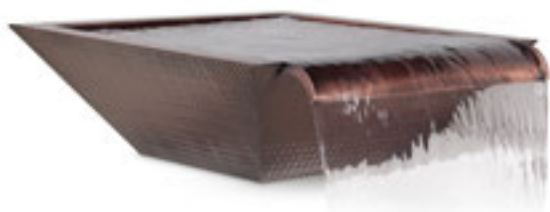

Maya Fire Bowl

Includes: Bowl, Fire Pan, Burner, Whistle Free Hose,
Gas Orifice, Mounting Bracket, Lava Rock.

24" Bowl
OPT-103-SQ24
OPT-103-SQ24E12V

Size: 24"
Height: 10"
Base: 12"
Burner: 8"
BTU: 45K
Sugg. Glass: 45 lbs.

30" Bowl
OPT-103-SQ30
OPT-103-SQ30E12V

Size: 30"
Height: 10"
Base: 15"
Burner: 10"
BTU: 65K
Sugg. Glass: 60 lbs.

36" Bowl
OPT-103-SQ36
OPT-103-SQ36E12V

Size: 36"
Height: 12"
Base: 18"
Burner: 10"
BTU: 65K
Sugg. Glass: 90 lbs.



Maya Fire & Water Bowl

Includes: Bowl, Copper Scupper (¾" Inlet) Fire Pan, Burner, Whistle Free Hose, Gas Orifice, Mounting Bracket, Lava Rock.



24" Bowl

OPT-24SCFW
OPT-24SCFWE12V

- » Size: 24"
- » Height: 10"
- » Base: 12"
- » Burner: 8"
- » BTU: 45K
- » Sugg. Glass: 45 lbs.
- » Scupper: 8"
- » GPM: 7-10

30" Bowl

OPT-30SCFW
OPT-30SCFWE12V

- » Size: 30"
- » Height: 10"
- » Base: 15"
- » Burner: 10"
- » BTU: 65K
- » Sugg. Glass: 60 lbs.
- » Scupper: 8"
- » GPM: 7-10

36" Bowl

OPT-36SCFW
OPT-36SCFWE12V

- » Size: 36"
- » Height: 12"
- » Base: 18"
- » Burner: 10"
- » BTU: 65K
- » Sugg. Glass: 90 lbs.
- » Scupper: 10"
- » GPM: 7-10

Maya Fire & Water Bowl - Gravity Spill

Includes: Bowl, Fire Pan, Burner, Whistle Free Hose, Gas Orifice, Mounting Bracket, Lava Rock. (1 ½" Water Inlet)



30" Bowl

OPT-SQ30FANDW
OPT-SQ30FANDWE12V

- » Size: 30"
- » Height: 10"
- » Base: 15"
- » Burner: 10"
- » BTU: 65K
- » Sugg. Glass: 45 lbs.
- » Scupper: 8"
- » GPM: 7-10

36" Bowl

OPT-SQ36FANDW
OPT-SQ36FANDWE12V

- » Size: 36"
- » Height: 12"
- » Base: 18"
- » Burner: 10"
- » BTU: 65K
- » Sugg. Glass: 60 lbs.
- » Scupper: 10"
- » GPM: 7-10

Maya Fire & Water Bowl - Wide Gravity Spill

Includes: Bowl, Fire Pan, Burner, Whistle Free Hose, Gas Orifice, Mounting Bracket, Lava Rock. (1 ½" Water Inlet)



30" Bowl

OPT-SQ30FWWS
OPT-SQ30FWWSE12V

- » Size: 30"
- » Height: 10"
- » Base: 15"
- » Burner: 10"
- » BTU: 65K
- » Sugg. Glass: 45 lbs.
- » Scupper: 8"
- » GPM: 15

36" Bowl

OPT-SQ36FWWS
OPT-SQ36FWWSE12V

- » Size: 36"
- » Height: 12"
- » Base: 18"
- » Burner: 10"
- » BTU: 65K
- » Sugg. Glass: 60 lbs.
- » Scupper: 10"
- » GPM: 15

Maya 4-Way Fire & Water Bowl

Includes: Bowl, Fire Pan, Burner, Whistle Free Hose, Gas Orifice, Mounting Bracket, Lava Rock. (1 ½" Water Inlet)



30" Bowl

OPT-30FW4W
OPT-30FW4WE12V

- » Size: 30"
- » Height: 10"
- » Base: 15"
- » Burner: 8"
- » BTU: 45K
- » Sugg. Glass: 60 lbs.
- » Scupper: 8"
- » GPM: 15

36" Bowl

OPT-36FW4W
OPT-36FW4WE12V

- » Size: 36"
- » Height: 12"
- » Base: 18"
- » Burner: 10"
- » BTU: 65K
- » Sugg. Glass: 90 lbs.
- » Scupper: 10"
- » GPM: 15

Optional Maya Canvas Cover

24" Cover - OPT-BCVR-2424
30" Cover - OPT-BCVR-3030
36" Cover - OPT-BCVR-3636

Linear Maya Fire Bowl

Includes: Bowl, Fire Pan, Burner, Whistle Free Hose, Gas Orifice, Mounting Bracket, Lava Rock.

48" Bowl

OPT-4820MCFO
OPT-4820MCFOE12V

- » Size: 48" x 20"
- » Height: 12"
- » Base: 38" x 10"
- » Burner: 30" Linear
- » BTU: 65K
- » Sugg. Glass: 70lbs.

60" Bowl

OPT-6020MCFO
OPT-6020MCFOE12V

- » Size: 60" x 20"
- » Height: 12"
- » Base: 50" x 10"
- » Burner: 42" Linear
- » BTU: 65K
- » Sugg. Glass: 95 lbs.

72" Bowl

OPT-7220MCFO
OPT-7220MCFOE12V

- » Size: 72" x 20"
- » Height: 12"
- » Base: 62" x 10"
- » Burner: 54" Linear
- » BTU: 65K
- » Sugg. Glass: 110 lbs.



Linear Maya Fire & Water Bowl

Includes: Bowl, Copper Scupper (¾" Inlet) Fire Pan, Burner, Whistle Free Hose, Gas Orifice, Mounting Bracket, Lava Rock.

48" Bowl

OPT-4820MCFW
OPT-4820MCFWE12V

- » Size: 48" x 20"
- » Height: 12"
- » Base: 38" x 10"
- » Burner: 30" Linear
- » BTU: 65K
- » Sugg. Glass: 70 lbs.
- » GPM: 15

60" Bowl

OPT-6020MCFW
OPT-6020MCFWE12V

- » Size: 60" x 20"
- » Height: 12"
- » Base: 50" x 10"
- » Burner: 42" Linear
- » BTU: 65K
- » Sugg. Glass: 95 lbs.
- » GPM: 15

72" Bowl

OPT-7220MCFW
OPT-7220MCFWE12V

- » Size: 72" x 20"
- » Height: 12"
- » Base: 62" x 10"
- » Burner: 54" Linear
- » BTU: 65K
- » Sugg. Glass: 110 lbs.
- » GPM: 15



Nile Fire & Water Bowl

Includes: Bowl, Copper Scupper (¾" Inlet) Fire Pan, Burner, Whistle Free Hose, Gas Orifice, Mounting Bracket, Lava Rock.

30" Bowl

OPT-30NLCPF
OPT-30NLCPF12V

- » Width: 30"
- » Length: 40"
- » Height: 14"
- » Base: 16" x 12"
- » Burner: 16"
- » BTU: 30K
- » GPM: 20

36" Bowl

OPT-36NLCPF
OPT-36NLCPF12V

- » Width: 36"
- » Length: 48"
- » Height: 14"
- » Base: 18" x 15"
- » Burner: 18"
- » BTU: 40K
- » GPM: 20



30" Nile Fire & Water Bowl

31" REMI COPPER BOWL



Remi Planter Bowl

Includes: Bowl Only
(Soil and plants not included.)

OPT-31RCPO

- » Size: 31"
- » Height: 11"
- » Base: 13"
- » Soil Usage: 2.5 ft³



Remi Water Bowl

Includes: Bowl, Copper Spillway,
(1 1/2" Water Inlet)

OPT-31RCWO

- » Size: 31"
- » Height: 11"
- » Base: 13"
- » Scupper: 10"
- » GPM: 7-10

Remi Planter & Water Bowl

Includes: Bowl, Copper Scupper (3/4" Inlet)
(Soil and plants not included)

OPT-31RCPW

- » Size: 31"
- » Height: 11"
- » Base: 13"
- » Soil Usage: 2.5 ft³
- » Scupper: 10"
- » GPM: 7-10



Remi Fire Bowl

Includes: Bowl, Fire Pan, Burner, Whistle
Free Hose, Gas Orifice, Mounting Bracket,
Lava Rock.

OPT-31RCFO
OPT-31RCFOE12V

- » Size: 31"
- » Height: 11"
- » Base: 13"
- » Burner: 10"
- » BTU: 45K
- » Sugg. Glass: 75 lbs.



Remi Fire & Water Bowl

Includes: Bowl, Copper Scupper (3/4" Inlet)
Fire Pan, Burner, Whistle Free Hose, Gas
Orifice, Mounting Bracket, Lava Rock.

OPT-31RCFW
OPT-31RCFWE12V

- » Size: 31"
- » Height: 11"
- » Base: 13"
- » Burner: 10"
- » BTU: 45K
- » Sugg. Glass: 75 lbs.
- » Scupper: 10"
- » GPM: 7-10



Fire & Water Bowl - Gravity Spill

Includes: Bowl, Fire Pan, Burner, Whistle
Free Hose, Gas Orifice, Mounting Bracket,
Lava Rock. (1 1/2" Water Inlet)

OPT-31RCFWGS
OPT-31RCFWGSE12V

- » Size: 31"
- » Height: 11.5"
- » Base: 13"
- » Burner: 10"
- » BTU: 45K
- » Sugg. Glass: 75 lbs.
- » Scupper: 10"
- » GPM: 7-10



**All Water Bowls Include
The Easy Flow Fitting**

All Water Bowls come with easy-flow
water fitting that accommodates a 1 1/2"
water line



Key Valve Upgrade
OPT-KVI

Installed Onto Bowl: Key Valve,
Installation Bracket, & Gas Hoses

**Optional Remi
Canvas Cover**
31" Cover - OPT-BCVR-31R



Avalon Water Bowl

Includes: Bowl, Copper Spillway, (1 1/2" Water Inlet)

24" Bowl

OPT-24AVSSWO - Stainless
OPT-24AVCPWO - Copper

- » Size: 24"
- » Height: 10"
- » Base: 12"
- » Scupper: 8"
- » GPM: 7-10

30" Bowl

OPT-30AVSSWO - Stainless
OPT-30AVCPWO - Copper

- » Size: 30"
- » Height: 13"
- » Base: 15"
- » Scupper: 8"
- » GPM: 7-10

36" Bowl

OPT-36AVSSWO - Stainless
OPT-36AVCPWO - Copper

- » Size: 36"
- » Height: 13"
- » Base: 18"
- » Scupper: 10"
- » GPM: 20



Avalon Fire & Water Bowl

Includes: Bowl, Copper Scupper (3/4" Inlet) Fire Pan, Burner, Whistle Free Hose, Gas Orifice, Mounting Bracket, Lava Rock.

24" Bowl

OPT-24AVCPFOW - Copper
OPT-24AVCPFWE12V - Copper
OPT-24AVSSFW - Stainless
OPT-24AVSSFWE12V - Stainless

- » Size: 24"
- » Height: 10"
- » Base: 12"
- » Burner: 8"
- » BTU: 45K
- » Sugg. Glass: 45 lbs.
- » GPM: 7-10

30" Bowl

OPT-30AVCPFOW - Copper
OPT-30AVCPFWE12V - Copper
OPT-30AVSSFW - Stainless
OPT-30AVSSFWE12V - Stainless

- » Size: 30"
- » Height: 13"
- » Base: 15"
- » Burner: 10"
- » BTU: 65K
- » Sugg. Glass: 60 lbs.
- » GPM: 7-10

36" Bowl

OPT-36AVCPFOW - Copper
OPT-36AVCPFWE12V - Copper
OPT-36AVSSFW - Stainless
OPT-36AVSSFWE12V - Stainless

- » Size: 36"
- » Height: 13"
- » Base: 18"
- » Burner: 10"
- » BTU: 65K
- » Sugg. Glass: 90 lbs.
- » GPM: 7-10



All Water Bowls Include The Easy Flow Fitting

All Water Bowls come with easy-flow water fitting that accommodates a 1 1/2" water line



Key Valve Upgrade

OPT-KVI

Installed Onto Bowl, Installation Bracket, & Gas Hoses

Optional Avalon Canvas Cover

24" Cover - OPT-BCVR-2424
30" Cover - OPT-BCVR-3030
36" Cover - OPT-BCVR-3636



Avalon Fire Bowl

Includes: Bowl, Fire Pan, Burner, Whistle Free Hose, Gas Orifice, Mounting Bracket, Lava Rock.

24" Bowl

OPT-24AVCPF - Copper
OPT-24AVCPFE12V - Copper
OPT-24AVSSF - Stainless
OPT-24AVSSFE12V - Stainless

- » Size: 24"
- » Height: 10"
- » Base: 12"
- » Burner: 8"
- » BTU: 45K
- » Sugg. Glass: 45 lbs.

30" Bowl

OPT-30AVCPF - Copper
OPT-30AVCPFE12V - Copper
OPT-30AVSSF - Stainless
OPT-30AVSSFE12V - Stainless

- » Size: 30"
- » Height: 13"
- » Base: 15"
- » Burner: 10"
- » BTU: 65K
- » Sugg. Glass: 60 lbs.

36" Bowl

OPT-36AVCPF - Copper
OPT-36AVCPFE12V - Copper
OPT-36AVSSF - Stainless
OPT-36AVSSFE12V - Stainless

- » Size: 36"
- » Height: 13"
- » Base: 18"
- » Burner: 10"
- » BTU: 65K
- » Sugg. Glass: 90 lbs.



24" WHITE

Cazo Planter Bowl

Includes: Bowl Only
(Soil and plants not included.)

24" Bowl
OPT-R24PCPO

- » Size: 24"
- » Height: 10"
- » Base: 10"
- » Soil Usage: 1.5 ft³

30" Bowl
OPT-R30PCPO

- » Size: 30"
- » Height: 12"
- » Base: 16"
- » Soil Usage: 3 ft³

36" Bowl
OPT-R36PCPO

- » Size: 36"
- » Height: 12"
- » Base: 20"
- » Soil Usage: 4.5 ft³

Cazo Planter & Water Bowl

Includes: Bowl, Copper Scupper (¾" Inlet)
(Soil and plants not included)

24" Bowl
OPT-R24PCPW

- » Size: 24"
- » Height: 10"
- » Base: 10"
- » Soil Usage: 1.5 ft³
- » Scupper: 8"
- » GPM: 7-10

30" Bowl
OPT-R30PCPW

- » Size: 30"
- » Height: 12"
- » Base: 16"
- » Soil Usage: 3 ft³
- » Scupper: 8"
- » GPM: 7-10

36" Bowl
OPT-R36PCPW

- » Size: 36"
- » Height: 12"
- » Base: 20"
- » Soil Usage: 4.5 ft³
- » Scupper: 10"
- » GPM: 7-10



24" SILVER VEIN

Cazo Water Bowl

Includes: Bowl, Copper Spillway,
(1 ½" Water Inlet)

24" Bowl
OPT-24PCWO

- » Size: 24"
- » Height: 10"
- » Base: 10"
- » Scupper: 8"
- » GPM: 7-10

30" Bowl
OPT-30PCWO

- » Size: 30"
- » Height: 12"
- » Base: 16"
- » Scupper: 8"
- » GPM: 7-10

36" Bowl
OPT-36PCWO

- » Size: 36"
- » Height: 12"
- » Base: 20"
- » Scupper: 10"
- » GPM: 7-10

POWDER COAT COLOR OPTIONS

When ordering, specify the concrete color by adding the color code to the end of the Part #. **Example:** 27" Brown Sedona Water Bowl = OPT-27RWO-BRN

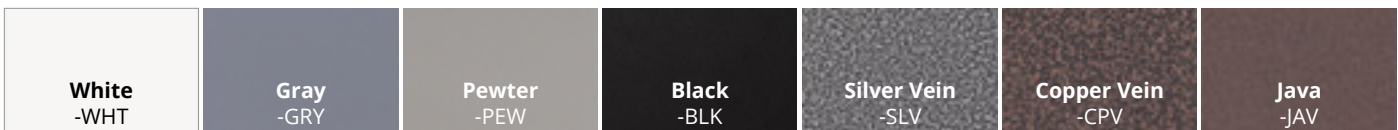

All Water Bowls Include The Easy Flow Fitting

All Water Bowls come with easy-flow water fitting that accommodates a 1 ½" water line



Key Valve Upgrade

OPT-KVI

Installed Onto Bowl: Key Valve, Installation Bracket, & Gas Hoses

Optional Cazo Canvas Cover

24" Cover - OPT-BCVR-24R
30" Cover - OPT-BCVR-30R
36" Cover - OPT-BCVR-36R

CAZO BOWLS - POWDER COAT FINISH



24" COPPER VEIN

Cazo Fire Bowl

Includes: Bowl, Fire Pan, Burner, Whistle Free Hose, Gas Orifice, Mounting Bracket, Lava Rock.

24" Bowl

OPT-R24PCFO
OPT-R24PCFOE12V

- » Size: 24"
- » Height: 10"
- » Base: 10"
- » Burner: 8"
- » BTU: 45K
- » Sugg. Glass: 20 lbs.

30" Bowl

OPT-R30PCFO
OPT-R30PCFOE12V

- » Size: 30"
- » Height: 12"
- » Base: 16"
- » Burner: 10"
- » BTU: 65K
- » Sugg. Glass: 35lbs.

36" Bowl

OPT-R36PCFO
OPT-R36PCFOE12V

- » Size: 36"
- » Height: 12"
- » Base: 20"
- » Burner: 10"
- » BTU: 65K
- » Sugg. Glass: 50 lbs.



24" GRAY

Cazo Fire & Water Bowl

Includes: Bowl, Copper Scupper (¾" Inlet) Fire Pan, Burner, Whistle Free Hose, Gas Orifice, Mounting Bracket, Lava Rock.

24" Bowl

OPT-R24PCFW
OPT-R24PCFWE12V

- » Size: 24"
- » Height: 10"
- » Base: 10"
- » Burner: 8"
- » BTU: 45K
- » Sugg. Glass: 20 lbs.
- » Scupper: 8"
- » GPM: 7-10

30" Bowl

OPT-R30PCFW
OPT-R30PCFWE12V

- » Size: 30"
- » Height: 12"
- » Base: 16"
- » Burner: 10"
- » BTU: 65K
- » Sugg. Glass: 35 lbs.
- » Scupper: 8"
- » GPM: 7-10

36" Bowl

OPT-R36PCFW
OPT-R36PCFWE12V

- » Size: 36"
- » Height: 12"
- » Base: 20"
- » Burner: 10"
- » BTU: 65K
- » Sugg. Glass: 50 lbs.
- » Scupper: 10"
- » GPM: 7-10

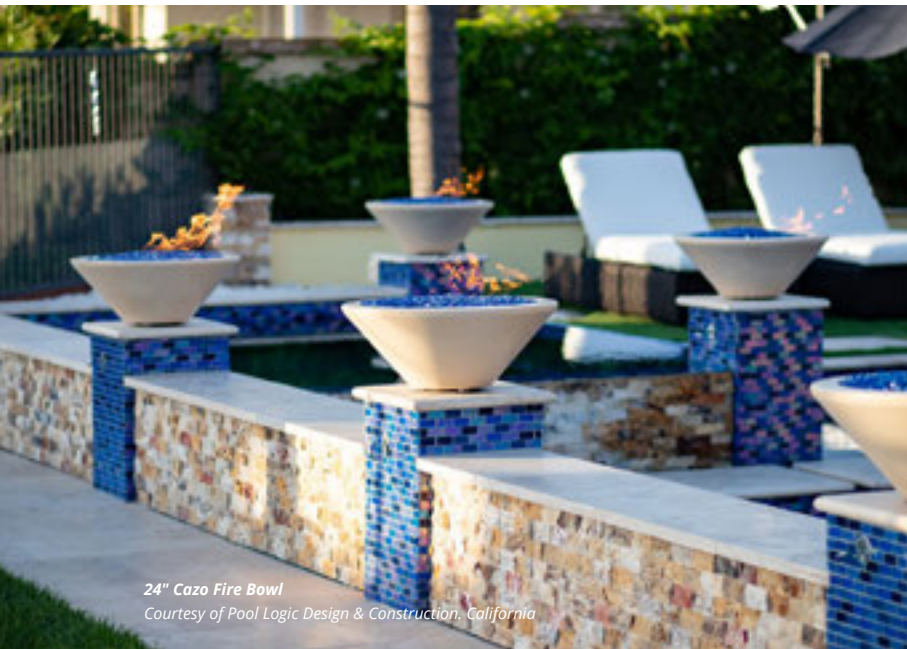

24" Cazo Fire Bowl
Courtesy of Pool Logic Design & Construction, California

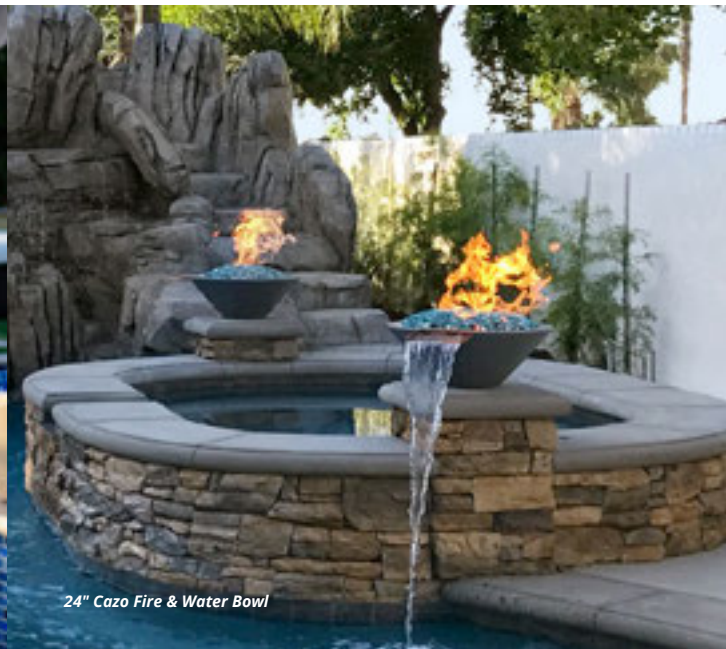

24" Cazo Fire & Water Bowl

Sedona Planter Bowl

Includes: Bowl Only
(Soil and plants not included.)

27" Bowl
OPT-27RPCPO

- » Size: 27"
- » Height: 10"
- » Base: 12"
- » Soil Usage: 1.5 ft³



27" GRAY

Sedona Planter & Water Bowl

Includes: Bowl, Copper Scupper (¾" Inlet)
(Soil and plants not included)

27" Bowl
OPT-27RPCPW

- » Size: 27"
- » Height: 10"
- » Base: 12"
- » Soil Usage: 1.5 ft³
- » Scupper: 8"
- » GPM: 7-10



27" BLACK

Sedona Water Bowl

Includes: Bowl, Copper Spillway,
(1 ½" Water Inlet)

27" Bowl
OPT-27RPCWO

- » Size: 27"
- » Height: 10"
- » Base: 12"
- » Scupper: 8"
- » GPM: 7-10



27" COPPER VEIN

Sedona Fire Bowl

Includes: Bowl, Fire Pan, Burner, Whistle Free Hose,
Gas Orifice, Mounting Bracket, Lava Rock.

27" Bowl
OPT-27RPCFO
OPT-27RPCFOE12V

- » Size: 27"
- » Height: 10"
- » Base: 12"
- » Burner: 8"
- » BTU: 45K
- » Sugg. Glass: 20 lbs.

POWDER COAT COLOR OPTIONS

When ordering, specify the concrete color by adding the color code to the end of the Part #. **Example:** 27" Brown Sedona Water Bowl = OPT-27RWO-BRN

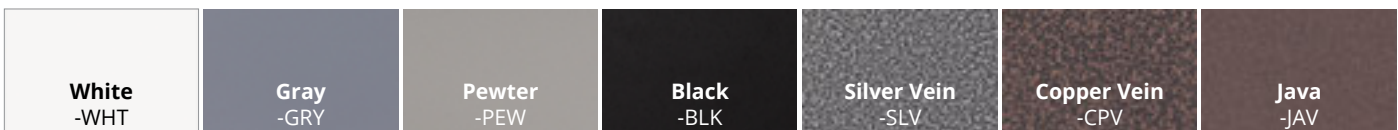

SEDONA BOWLS - POWDER COAT FINISH



27" LIMESTONE

Sedona Fire & Water Bowl

Includes: Bowl, Copper Scupper (¾" Inlet) Fire Pan, Burner, Whistle Free Hose, Gas Orifice, Mounting Bracket, Lava Rock.

27" Bowl
OPT-27RPCFW
OPT-27RPCFWE12V

- » Size: 27"
- » Height: 10"
- » Base: 12"
- » Burner: 8"
- » BTU: 45K
- » Sugg. Glass: 20 lbs.
- » Scupper: 8"
- » GPM: 7-10



All Water Bowls Include The Easy Flow Fitting

All Water Bowls come with easy-flow water fitting that accommodates a 1 ½" water line



Key Valve Upgrade

OPT-KVI

Installed Onto Bowl: Key Valve, Installation Bracket, & Gas Hoses

Optional Sedona Canvas Cover

27" Cover - OPT-BCVR-27R



27" Sedona Fire Bowl in Copper Vein Finish





24" GRAY

Maya Planter Bowl

Includes: Bowl Only
(Soil and plants not included.)

24" Bowl
OPT-245QPCPO

- » Size: 24"
- » Height: 10"
- » Base: 12"
- » Soil Usage: 2 ft³

30" Bowl
OPT-305QPCPO

- » Size: 30"
- » Height: 10"
- » Base: 15"
- » Soil Usage: 3 ft³

36" Bowl
OPT-365QPCPO

- » Size: 36"
- » Height: 12"
- » Base: 18"
- » Soil Usage: 5.25 ft³

Maya Planter & Water Bowl

Includes: Bowl, Copper Scupper (¾" Inlet)
(Soil and plants not included)

24" Bowl
OPT-245QPCPW

- » Size: 24"
- » Height: 10"
- » Base: 12"
- » Soil Usage: 2 ft³
- » Scupper: 8"
- » GPM: 7-10

30" Bowl
OPT-305QPCPW

- » Size: 30"
- » Height: 10"
- » Base: 15"
- » Soil Usage: 3 ft³
- » Scupper: 8"
- » GPM: 7-10

36" Bowl
OPT-365QPCPW

- » Size: 36"
- » Height: 12"
- » Base: 18"
- » Soil Usage: 5.25 ft³
- » Scupper: 10"
- » GPM: 7-10



24" BLACK

Maya Water Bowl

Includes: Bowl, Copper Spillway,
(1 ½" Water Inlet)

24" Bowl
OPT-245QPCWO

- » Size: 24"
- » Height: 10"
- » Base: 12"
- » Scupper: 8"
- » GPM: 7-10

30" Bowl
OPT-305QPCWO

- » Size: 30"
- » Height: 10"
- » Base: 15"
- » Scupper: 8"
- » GPM: 7-10

36" Bowl
OPT-365QPCWO

- » Size: 36"
- » Height: 12"
- » Base: 18"
- » Scupper: 10"
- » GPM: 7-10

POWDER COAT COLOR OPTIONS

When ordering, specify the concrete color by adding the color code to the end of the Part #. **Example:** 27" Brown Sedona Water Bowl = OPT-27RWO-BRN

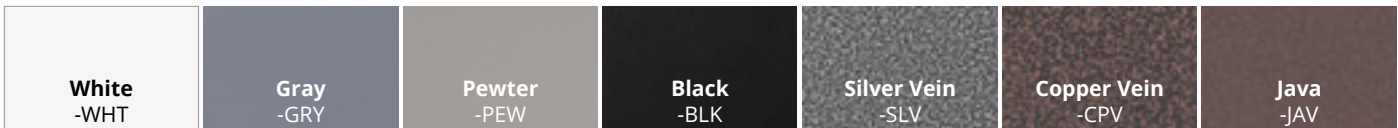

All Water Bowls Include The Easy Flow Fitting

All Water Bowls come with easy-flow water fitting that accommodates a 1 ½" water line



Key Valve Upgrade

OPT-KVI

Installed Onto Bowl; Key Valve, Installation Bracket, & Gas Hoses

Optional Maya Canvas Cover

24" Cover - OPT-BCVR-2424
30" Cover - OPT-BCVR-3030
36" Cover - OPT-BCVR-3636

MAYA BOWLS - POWDER COAT FINISH



24" WHITE

Maya Fire Bowl



Includes: Bowl, Fire Pan, Burner, Whistle Free Hose, Gas Orifice, Mounting Bracket, Lava Rock.

24" Bowl

OPT-24SQPCFO
OPT-24SQPCFOE12V

- » Size: 24"
- » Height: 10"
- » Base: 12"
- » Burner: 8"
- » BTU: 45K
- » Sugg. Glass: 45 lbs.

30" Bowl

OPT-30SQPCFO
OPT-30SQPCFOE12V

- » Size: 30"
- » Height: 10"
- » Base: 15"
- » Burner: 10"
- » BTU: 65K
- » Sugg. Glass: 60 lbs.

36" Bowl

OPT-36SQPCFO
OPT-36SQPCFOE12V

- » Size: 36"
- » Height: 12"
- » Base: 18"
- » Burner: 10"
- » BTU: 65K
- » Sugg. Glass: 90 lbs.



24" COPPER
VEIN

Maya Fire & Water Bowl

Includes: Bowl, Copper Scupper (3/4" Inlet) Fire Pan, Burner, Whistle Free Hose, Gas Orifice, Mounting Bracket, Lava Rock.

24" Bowl

OPT-24SQPCFW
OPT-24SQPCFWE12V

- » Size: 24"
- » Height: 10"
- » Base: 12"
- » Burner: 8"
- » BTU: 45K
- » Sugg. Glass: 45 lbs.
- » Scupper: 8"
- » GPM: 7-10

30" Bowl

OPT-30SQPCFW
OPT-30SQPCFWE12V

- » Size: 30"
- » Height: 10"
- » Base: 15"
- » Burner: 10"
- » BTU: 65K
- » Sugg. Glass: 60 lbs.
- » Scupper: 8"
- » GPM: 7-10

36" Bowl

OPT-36SQPCFW
OPT-36SQPCFWE12V

- » Size: 36"
- » Height: 12"
- » Base: 18"
- » Burner: 10"
- » BTU: 65K
- » Sugg. Glass: 90 lbs.
- » Scupper: 10"
- » GPM: 7-10



30" Maya Wide Spill Water Bowl



30" Maya Fire Bowl

INTRODUCING THE FLAME SENSE FOR BOWLS & FIRE PITS

The Flame Sense valve is the solution for a certified match lit unit with added safety features and CSA certification. It does not require any batteries or electrical connections so installation is easier and simpler than ever. This unit is compatible with majority of T.O.P's fire features.



◆ **Thermopile Technology**

The thermopile sensors in this unit is the defining factor of safety. By using a thermopile sensor this unit will not release gas without a flame being present.

◆ **Automatic Flame Shut Off**

By using the same thermopile technology, the unit is able to sense if a flame has gone out and automatically turn itself off. This is great in case a sudden gust of wind or rainfall extinguishes your flames.

◆ **Electricity Free**

The unit does not use batteries or electrical current to operate. This makes it safe to install near bodies of water, eliminates the need to run electrical lines and eases up installation.

◆ **Easy Installation**

The valve uses two simple gas in & gas out inlets. Simply connect two gas hoses with flared fittings to get this unit running.

◆ **Weather Tested**

Proven to operate properly in mild wind, rain & snow.

◆ **Compact Construction**

The small construction allows it to be installed in tight spaces.

◆ **1 Year Limited Warranty**

Covers all components of the Electronic Ignition System

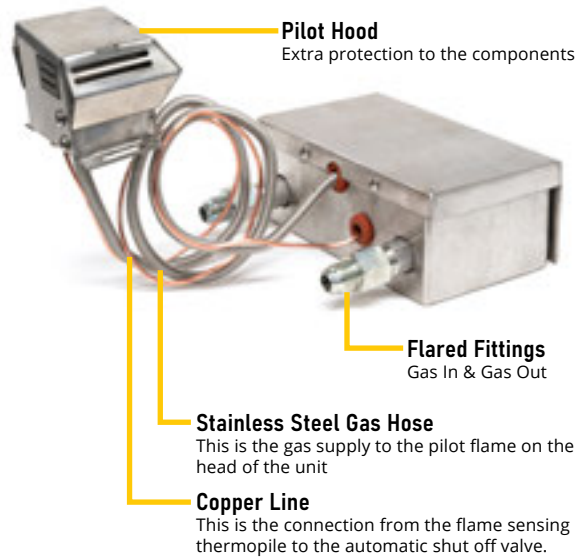

WHAT'S INCLUDED IN YOUR BOWL?

MATCH LIT FIRE BOWLS

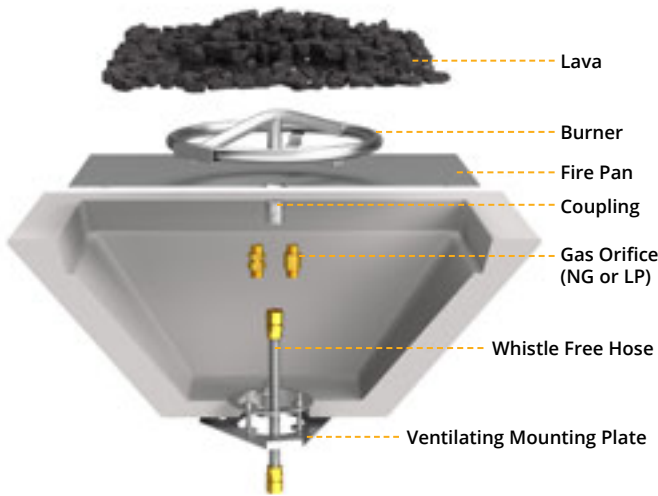

MATCH LIT FIRE & WATER BOWLS

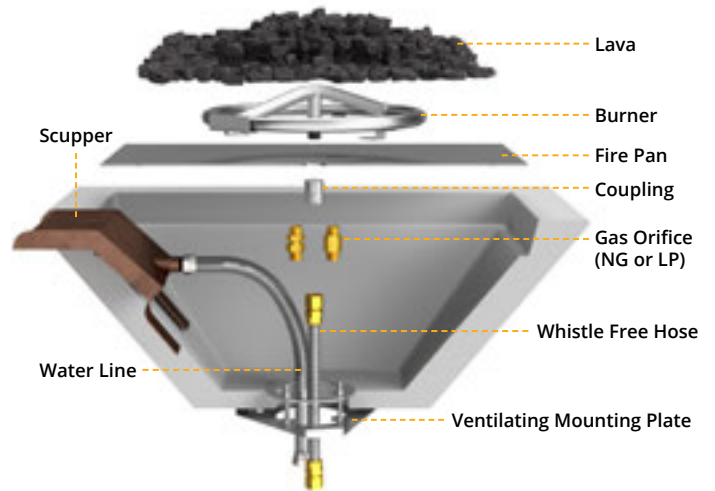

12V/110V FIRE BOWLS

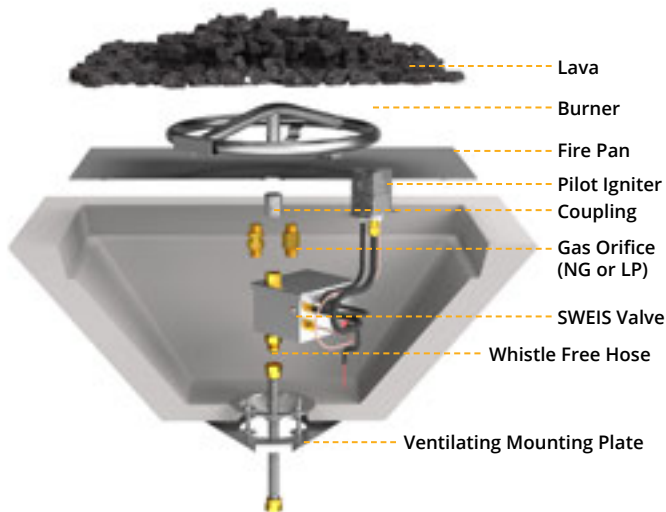

12V/110V FIRE & WATER BOWLS

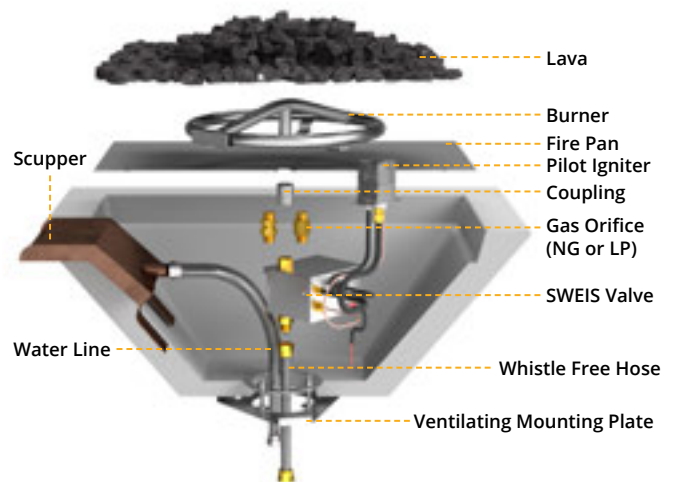

Liquid Propane

Liquid Propane applications require a Brass Air Mixer Orifice. This orifice integrates air into the propane for a cleaner burning flame. This prevents soot from being created and staining the unit and other surroundings.

Natural Gas

Natural Gas applications come with a brass orifice mounted directly underneath the burner. Key Valves must be mounted within arms reach of the burner.

NOTE: Key Valves may be installed onto the face of the bowl. To have your bowls shipped like this for an addi-

tional fee, add OPT-KVI to your order (Includes Key Valve, Whistle Free Hose & Installation)



Mounting Brackets

All fire bowls come shipped with a mounting bracket. This mounting bracket provides ventilation and a secure mount.

WARRANTY IS VOID IF THE MOUNTING BRACKET IS NOT INSTALLED.

Propane & Glass

It is not recommended to use any sort of fire glass or glass pebbles in Liquid Propane applications. Propane is 1.5x heavier than air and sinks, decorative glass is dense and may not allow the propane to properly rise. Propane may collect and pool under the surface of the glass or inside the enclosure creating a potentially dangerous situation.

SCUPPERS AND WATER FEATURES

The Outdoor Plus has many styles of scuppers to compliment any style pool & water feature. Each scupper starts as a sheet of high grade copper and then measured, cut and welded all by hand. Each piece is then finished with a dark patina for a luxurious look.

- ◇ Custom Sizes & Styles Available
- ◇ Suitable for Chlorine & Salt Water Pools
- ◇ Manufactured By Hand in the USA
- ◇ Dark Patina Coating Applied by Hand
- ◇ Lacquer Finish to slow down natural patina
- ◇ All Items Include a port for ground wires

» All scuppers utilize a 1½" water inlet.



Radius Style



PART #	W	H	D
OPT-RSE8	8"	4"	8"
OPT-RSE12	12"	4"	8"
OPT-RSE24	24"	4"	8"
OPT-RSE36	36"	4"	8"
OPT-RSE48	48"	4"	8"



Smooth Flow Radius Style

PART #	W	H	D
OPT-SFR8	8"	4"	7"
OPT-SFR12	12"	4"	7"
OPT-SFR24	24"	4"	7"
OPT-SFR36	36"	4"	7"
OPT-SFR48	48"	4"	7"

Straight Spillway

DOES NOT UTILIZE A WATER INLET

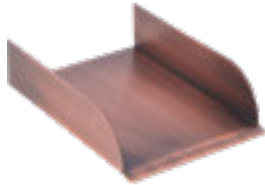

PART #	W	H	D
OPT-SS6	6"	2"	8"
OPT-SS8	8"	2"	8"
OPT-SS10	10"	2"	8"
OPT-SS12	12"	2"	8"



Smooth Flow Style

PART #	W	H	D
OPT-SFS8	8"	4"	8"
OPT-SFS12	12"	4"	8"
OPT-SFS24	24"	4"	8"
OPT-SFS36	36"	4"	8"
OPT-SFS48	48"	4"	8"

U-Shaped Style



PART #	W	H	D
OPT-USS6	6"	6"	10"
OPT-USS8	8"	6"	10"
OPT-USS10	10"	6"	10"
OPT-USS12	12"	6"	10"



Scoop Style

PART #	W	H	D
OPT-SCS4	4"	4"	4"
OPT-SCS6	6"	6"	4"
OPT-SCS8	8"	8"	4"

Box Style



PART #	W	H	D
OPT-BX6	6"	6"	8"
OPT-BX8	8"	8"	8"
OPT-BX10	10"	10"	8"
OPT-BX12	12"	12"	8"



Arch Flow

PART #	W	H	D
OPT-ARF8	8"	5"	8"
OPT-ARF12	12"	5"	8"
OPT-ARF24	24"	5"	8"
OPT-ARF36	36"	5"	8"
OPT-ARF48	48"	5"	8"

V-Shape Style



PART #	W	H	D
OPT-WS6	6"	5"	12"
OPT-WS8	8"	5"	12"
OPT-WS10	10"	5"	12"
OPT-WS12	12"	5"	12"



Single V Scupper

PART #	W	H	D
OPT-VSS4	4"	4"	3"
OPT-VSS5	5"	4"	3"
OPT-VSS6	6"	4"	3"
OPT-VSS7	7"	4"	3"
OPT-VSS8	8"	4"	3"

Rain Fall Style



PART #	W	H	D
OPT-RNS6	6"	4"	3.5"
OPT-RNS8	8"	4"	3.5"
OPT-RNS12	12"	4"	3.5"
OPT-RNS24	24"	4"	3.5"
OPT-RNS36	36"	4"	3.5"

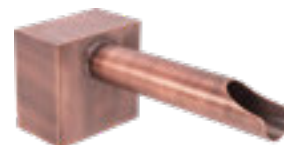

Cannon Style

PART #	W	H	D
OPT-CS2	2"	6"	12"
OPT-CS3	3"	6"	12"

SCUPPERS AND WATER FEATURES

Mini Scuppers Available In Two Options
Threaded Back & Open Back



Angled Mini Scupper

THREADED BACK	OPEN BACK	W	H	L
OPT-MSAN12T	OPT-MSAN12O	2.5"	2.5"	12"



Boxed Mini Scupper

THREADED BACK	OPEN BACK	W	H	L
OPT-MSBX12T	OPT-MSBX12O	2.5"	2.5"	12"



Cannon Mini Scupper

THREADED BACK	OPEN BACK	W	H	L
OPT-MSCN12T	OPT-MSCN12O	2"	2"	12"



Chamfered Mini Scupper

THREADED BACK	OPEN BACK	W	H	L
OPT-MSCH12T	OPT-MSCH12O	2.5"	2.5"	12"



Scalloped Mini Scupper

THREADED BACK	OPEN BACK	W	H	L
OPT-MSSC12T	OPT-MSSC12O	2.5"	2.5"	12"



Cazo Water Bowl - Wall Mounted

Includes Bowl Only (1 1/2" Water Inlet)

PART #	WIDTH	BASE WIDTH	HEIGHT	DEPTH	GPM
OPT-R24CPWMT	24"	10"	10"	15"	12-15
OPT-R30CPWMT	30"	12"	10"	18"	12-15



Maya Water Bowl - Wall Mounted

Includes Bowl Only (1 1/2" Water Inlet)

PART #	WIDTH	BASE WIDTH	HEIGHT	DEPTH	GPM
OPT-24SCWMT	24"	12"	10"	15"	12-15
OPT-30SCWMT	30"	12"	10"	18"	12-15



Sedona Fire Pit - Wide Ledge

Cannot Store Propane Tank

OPT-SEDWL48 Match Lit Ignition
OPT-SEDWL48FSML Flame Sense
OPT-SEDWL48EKIT 110V Ignition

- » Diameter: 48"
- » Height: 15"
- » Base Diameter: 27
- » Burn Area Diameter: 29"
- » Weight: 215 lbs.
- » BTU: 65K
- » Sugg. Fire Glass: 100 lbs.

OPT-SEDWL60 Match Lit Ignition
OPT-SEDWL60FSML Flame Sense
OPT-SEDWL60EKIT 110V Ignition

- » Diameter: 60"
- » Height: 15"
- » Base Diameter: 38"
- » Burn Area Diameter: 40"
- » Weight: 300 lbs.
- » BTU: 65K
- » Sugg. Fire Glass: 150 lbs.

Optional Accessories

Unit	Canvas Cover	Stainless Lid
48" Sedona	OPT-CVR-48R	OPT-30RC
60" Sedona	OPT-CVR-60R	OPT-42RC



48" BROWN

Sedona Fire Pit - Narrow Ledge

Cannot Store Propane Tank

OPT-SED48 Match Lit Ignition
OPT-SED48FSML Flame Sense
OPT-SED48EKIT 110V Ignition

- » Diameter: 48"
- » Height: 15"
- » Base Diameter: 27
- » Burn Area Diameter: 40"
- » Weight: 215 lbs.
- » BTU: 65K
- » Sugg. Fire Glass: 150 lbs.

OPT-SED60 Match Lit Ignition
OPT-SED60FSML Flame Sense
OPT-SED60EKIT 110V Ignition

- » Diameter: 60"
- » Height: 15"
- » Base Diameter: 38"
- » Burn Area Diameter: 54"
- » Weight: 300 lbs.
- » BTU: 65K
- » Sugg. Fire Glass: 200 lbs.

Optional Accessories

Unit	Canvas Cover	Stainless Lid
48" Sedona	OPT-CVR-48R	OPT-48RC
60" Sedona	OPT-CVR-60R	OPT-60RC



48" CHESTNUT



Newport Collection

Includes Stainless Steel Door For Propane Tank Storage.

6' Newport Fire Table

OPT-NPTT72 Match Lit Ignition
OPT-NPTT72FSML Flame Sense
OPT-NPTT72EKIT 110V Ignition

- » Dimensions: 72" x 36"
- » Height: 30"
- » Burning Area: 48" x 10"
- » Overhang: 12"
- » Weight: 1100 lbs.
- » BTU: 65K
- » Sugg. Fire Glass: 125 lbs.

10' Newport Fire Table

OPT-NPTT120 Match Lit Ignition
OPT-NPTT120FSML Flame Sense
OPT-NPTT120EKIT 110V Ignition

- » Dimensions: 120" x 48"
- » Height: 30"
- » Burning Area: 78" x 12"
- » Overhang: 12"
- » Weight: 1465 lbs.
- » BTU: 120K
- » Sugg. Fire Glass: 125 lbs.

12' Newport Fire Table

OPT-NPTT144 Match Lit Ignition
OPT-NPTT144FSML Flame Sense
OPT-NPTT144EKIT 110V Ignition

- » Dimensions: 144" x 48"
- » Height: 30"
- » Burning Area: 102" x 12"
- » Overhang: 12"
- » Weight: 1750 lbs.
- » BTU: 160K
- » Sugg. Fire Glass: 175 lbs.



12' BROWN

Optional Accessories

Unit	Canvas Cover	Stainless Lid	Glass Wind Guard
6' Newport	OPT-CVR-7236	OPT-RC1250	OPT-WG-5214
10' Newport	OPT-CVR-12048	OPT-RC1480	OPT-WG-8216
12' Newport	OPT-CVR-14448	OPT-RC14104	OPT-WG-10616

Includes stainless steel door for propane tank storage.

Luna Collection

Cannot Store Propane Tank

30" Luna

OPT-LUN30 Match Lit Ignition
OPT-LUN30FSML Flame Sense
OPT-LUN30EKIT 110V Ignition

- » Diameter: 30"
- » Height: 14.5"
- » Base Diameter: 13"
- » Burn Area Diameter: 24"
- » Weight: 140 lbs.
- » BTU: 65K
- » Sugg. Fire Glass: 50 lbs.

38" Luna

OPT-LUN38 Match Lit Ignition
OPT-LUN38FSML Flame Sense
OPT-LUN38EKIT 110V Ignition

- » Diameter: 38"
- » Height: 16.5"
- » Base Diameter: 16"
- » Burn Area Diameter: 30"
- » Weight: 285 lbs.
- » BTU: 65K
- » Sugg. Fire Glass: 75 lbs.



30" BROWN

Optional Accessories

Unit	Canvas Cover	Stainless Lid
30" Luna	OPT-CVR-30R	OPT-30RC
38" Luna	OPT-CVR-38R	OPT-38RC

Metallic Finishes and Rustic Finishes are available at an extra charge

When ordering, specify the concrete color by adding the color code to the end of the Part #. Example: 27" Brown Sedona Water Bowl = OPT-27RWO-BRN

Black -BLK	Ash -ASH	Natural Gray -NGY	Gray -GRY	White Limestone -LIM	Chocolate -CHC	Chestnut -CST	Brown -BRN	Vanilla -VAN
Rustic Gray -RGR	Moss Stone -RMS	Rustic White -RWH	Coffee -RCF	Slate -MSL	Silver -MSV	Pearl -MPR	Bronze -MBR	Copper -MCP

FIRE PITS & FIRE TABLES

All fire pits include: Fire Pan, Burner, Key Valve, Key, Gas Hoses, Lava Rock.
For Match Lit w/ Flame Sense add "-FSML" to part #. For 110V Ignition, add "-EKIT"

Sonoma Fire Pit

Cannot Store Propane Tank

OPT-SONMA38 Match Lit Ignition
OPT-SONMA38FSML Flame Sense
OPT-SONMA38EKIT 110V Ignition

- » Diameter: 38"
- » Height: 25"
- » Base Diameter: 17.5"
- » Burn Area Diameter: 32"
- » Weight: 285 lbs.
- » BTU: 65K
- » Sugg. Fire Glass: 75 lbs.

Optional Accessories

Unit	Canvas Cover	Stainless Lid
Sonoma	OPT-CVR-38R	OPT-38RC



BROWN FINISH SHOWN

Sienna Fire Pit

Cannot store propane tank.

OPT-RF37 Match Lit Ignition
OPT-RF37FSML Flame Sense
OPT-RF37EKIT 110V Ignition

- » Diameter: 37"
- » Height: 25"
- » Base Diameter: 17.5"
- » Burn Area Diameter: 20"
- » Weight: 285 lbs.
- » BTU: 65K
- » Sugg. Fire Glass: 25 lbs.

Optional Accessories

Canvas Cover	OPT-CVR-38R
Stainless Steel Lid	OPT-22RC



CHESTNUT FINISH SHOWN

Cazo Fire Pit - Narrow Ledge

Cannot Store Propane Tank

48" Cazo

OPT-CZNL48 Match Lit Ignition
OPT-CZNL48FSML Flame Sense
OPT-CZNL48EKIT 110V Ignition

- » Diameter: 48"
- » Height: 17"
- » Base Diameter: 20"
- » Burn Area Diameter: 40"
- » Weight: 260 lbs.
- » BTU: 65K
- » Sugg. Fire Glass: 150 lbs.

60" Cazo

OPT-CZNL60 Match Lit Ignition
OPT-CZNL60FSML Flame Sense
OPT-CZNL60EKIT 110V Ignition

- » Diameter: 60"
- » Height: 21"
- » Base Diameter: 28"
- » Burn Area Diameter: 50"
- » Weight: 315 lbs.
- » BTU: 65K
- » Sugg. Fire Glass: 200 lbs.

Optional Accessories

Unit	Canvas Cover	Stainless Lid
48" Cazo	OPT-CVR-48R	OPT-48RC
60" Cazo	OPT-CVR-60R	OPT-60RC



48" CHESTNUT
POLISHED LAVA UPGRADE SOLD SEPARATELY

Cazo Fire Pit - Wide Ledge

Cannot Store Propane Tank

OPT-CZ48 Match Lit Ignition
OPT-CZ48FSML Flame Sense
OPT-CZ48EKIT 110V Ignition

- » Diameter: 48"
- » Height: 17"
- » Base Diameter: 20"
- » Burn Area Diameter: 29"
- » Weight: 260 lbs.
- » BTU: 65K
- » Sugg. Fire Glass: 75 lbs.

OPT-CZ60 Match Lit Ignition
OPT-CZ60FSML Flame Sense
OPT-CZ60EKIT 110V Ignition

- » Diameter: 60"
- » Height: 20"
- » Base Diameter: 28"
- » Burn Area Diameter: 40"
- » Weight: 315 lbs.
- » BTU: 65K
- » Sugg. Fire Glass: 125 lbs.

Optional Accessories

Unit	Canvas Cover	Stainless Lid
48" Cazo	OPT-CVR-48R	OPT-30RC
60" Cazo	OPT-CVR-60R	OPT-42RC



60" GRAY

Tempe Fire Pit

Cannot Store Propane Tank

OPT-TEM48 Match Lit Ignition
OPT-TEM48FSML Flame Sense
OPT-TEM48EKIT 110V Ignition

- » Diameter: 48"
- » Height: 16"
- » Burn Area Diameter: 28"
- » Weight: 370 lbs.
- » BTU: 65K
- » Sugg. Fire Glass: 50 lbs.

Optional Accessories

Unit	Canvas Cover	Stainless Lid
48" Tempe	OPT-CVR-48R	OPT-30RC



VANILLA FINISH

32" Florence Fire Pit

Includes Stainless Steel Door For Short 11lb. Propane Tank ONLY.

OPT-FL3218 Match Lit
OPT-FL3218FSML Flame Sense
OPT-FL3218EKIT 110V Plug & Play

- » Diameter: 32"
- » Height: 18"
- » Burn Area Diameter: 24"
- » Weight: 280 lbs.
- » BTU: 65K
- » Sugg. Fire Glass: 40 lbs.



Optional Accessories

Unit	Canvas Cover	Stainless Lid
32" Florence	OPT-CVR-32R	OPT-26RC



BROWN FINISH SHOWN

42" Florence Fire Pit

Cannot Store Propane Tank

OPT-FL42 Match Lit
OPT-FL42FSML Flame Sense
OPT-FL42EKIT 110V Plug & Play

- » Diameter: 42"
- » Height: 12"
- » Burn Area Diameter: 25"
- » Weight: 315 lbs.
- » BTU: 65K
- » Sugg. Fire Glass: 50 lbs.

Optional Accessories

Unit	Canvas Cover	Stainless Lid
42" Florence	OPT-CVR-42R	OPT-28RC



LIMESTONE FINISH SHOWN

42" Florence Fire Table - 24" Tall

Includes Stainless Steel Door For Propane Tank Storage.

OPT-FL4224 Match Lit
OPT-FL4224FSML Flame Sense
OPT-FL4224EKIT 110V Plug & Play

- » Diameter: 42"
- » Height: 24"
- » Burn Area Diameter: 25"
- » Weight: 425 lbs.
- » BTU: 65K
- » Sugg. Fire Glass: 55 lbs.



Optional Accessories

Unit	Canvas Cover	Stainless Lid
42" Florence	OPT-CVR-42R	OPT-28RC



CHOCOLATE FINISH SHOWN

FIRE PITS & FIRE TABLES

All fire pits include: Fire Pan, Burner, Key Valve, Key, Gas Hoses, Lava Rock.
For Match Lit w/ Flame Sense add "-FSML" to part #. For 110V Ignition, add "-EKIT"

46" Florence Fire Pit

Includes Stainless Steel Door For Propane Tank Storage.

OPT-FL4620 Match Lit
OPT-FL4620FSML Flame Sense
OPT-FL4620EKIT 110V Plug & Play

- » Diameter: 46"
- » Height: 20"
- » Burn Area Diameter: 21"
- » Weight: 360 lbs.
- » BTU: 65K
- » Sugg. Fire Glass: 40 lbs.



Optional Accessories

Unit	Canvas Cover	Stainless Lid
46" Florence	OPT-CVR-48R	OPT-23RC



ASH FINISH SHOWN



72" FLORENCE IN RUSTIC COFFEE FINISH

54" Florence Fire Pit

Includes SS Door For Propane Tank Storage.

OPT-FL54 Match Lit
OPT-FL54FSML Flame Sense
OPT-FL54EKIT 110V Plug & Play

- » Diameter: 54"
- » Height: 20"
- » Burn Area Diameter: 30"
- » Weight: 490 lbs.
- » BTU: 65K
- » Sugg. Fire Glass: 100 lbs.



Optional Accessories

Canvas Cover	OPT-CVR-54R
Stainless Steel Lid	OPT-32RC

72" Florence Fire Pit

*Shown On This Page

Includes SS Door For Propane Tank Storage.

OPT-FL72 Match Lit
OPT-FL72FSML Flame Sense
OPT-FL72EKIT 110V Plug & Play

- » Diameter: 72"
- » Height: 20"
- » Burn Area Diameter: 48"
- » Weight: 675 lbs.
- » BTU: 65K
- » Sugg. Fire Glass: 100 lbs.



Optional Accessories

Canvas Cover	OPT-CVR-72R
Stainless Steel Lid	OPT-50RC



54" ASH FINISH

Regal Collection

Cannot Store Propane Tank

48" Regal

OPT-RGL48 Match Lit
OPT-RGL48FSML Flame Sense
OPT-RGL48EKIT 110V Plug & Play

- » Dimensions: 48" x 24"
- » Height: 13"
- » Burning Area: 34" x 10" x 2"
- » Weight: 195 lbs.
- » BTU: 45K
- » Sugg. Fire Glass: 50 lbs.

54" Regal

OPT-RGL54 Match Lit
OPT-RGL54FSML Flame Sense
OPT-RGL54EKIT 110V Plug & Play

- » Dimensions: 54" x 24"
- » Height: 13"
- » Burning Area: 40" x 10" x 2"
- » Weight: 215 lbs.
- » BTU: 65K
- » Sugg. Fire Glass: 50 lbs.

60" Regal

OPT-RGL60 Match Lit
OPT-RGL60FSML Flame Sense
OPT-RGL60EKIT 110V Plug & Play

- » Dimensions: 60" x 24"
- » Height: 13"
- » Burning Area: 48" x 10" x 2"
- » Weight: 400 lbs.
- » BTU: 65K
- » Sugg. Fire Glass: 75 lbs.

Optional Accessories

Unit	Canvas Cover	Stainless Lid	Glass Wind Guard
48" Regal	OPT-CVR-4824	OPT-RC1236	OPT-WG-3814
54" Regal	OPT-CVR-5424	OPT-RC1242	OPT-WG-4414
60" Regal	OPT-CVR-6024	OPT-RC1250	OPT-WG-5214



72" X 16" X 16" IN NATURAL GRAY FINISH

Carmen Collection

72" Carmen - 16" Tall

Cannot Store Propane Tank

OPT-CRM7216 Match Lit
OPT-CRM7216FSML Flame Sense
OPT-CRM7216EKIT 110V Plug & Play

- » Dimensions: 72" x 16"
- » Height: 16"
- » Burn Area: 54" x 8" x 2"
- » Weight: 465 lbs.
- » BTU: 65K
- » Sugg. Fire Glass: 75 lbs.

72" Carmen - 24" Tall

Includes Stainless Steel Door For Propane Tank Storage.

OPT-CRM7224 Match Lit
OPT-CRM7224FSML Flame Sense
OPT-CRM7224EKIT 110V Plug & Play

- » Dimensions: 72" x 16"
- » Height: 24"
- » Burn Area: 54" x 8" x 2"
- » Weight: 610 lbs.
- » BTU: 65K
- » Sugg. Fire Glass: 75 lbs.



Optional Accessories

Canvas Cover	OPT-CVR-7216
Stainless Steel Lid	OPT-RC1056
Glass Wind Guard	OPT-WG-5814

FIRE PITS & FIRE TABLES

All fire pits include: Fire Pan, Burner, Key Valve, Key, Gas Hoses, Lava Rock.
For Match Lit w/ Flame Sense add "-FSML" to part #. For 110V Ignition, add "-EKIT"



60" ASH FINISH

Del Mar Collection

Cannot Store Propane Tank

48" Del Mar

OPT-CORGFRC48 Match Lit
OPT-CORGFRC48FSML Flame Sense
OPT-CORGFRC48EKIT 110V Plug & Play

- » Dimensions: 48" x 28"
- » Height: 15"
- » Burning Area: 30" x 10"
- » Weight: 375 lbs.
- » BTU: 45K
- » Sugg. Fire Glass: 50 lbs.

60" Del Mar

OPT-DEL6028 Match Lit
OPT-DEL6028FSML Flame Sense
OPT-DEL6028EKIT 110V Plug & Play

- » Dimensions: 60" x 28"
- » Height: 15"
- » Burning Area: 42" x 10"
- » Weight: 435 lbs.
- » BTU: 65K
- » Sugg. Fire Glass: 50 lbs.

72" Del Mar

OPT-DEL7228 Match Lit
OPT-DEL7228FSML Flame Sense
OPT-DEL7228EKIT 110V Plug & Play

- » Dimensions: 72" x 28"
- » Height: 15"
- » Burning Area: 54" x 10"
- » Weight: 510 lbs.
- » BTU: 65K
- » Sugg. Fire Glass: 75 lbs.

84" Del Mar

OPT-DEL8428 Match Lit
OPT-DEL8428FSML Flame Sense
OPT-DEL8428EKIT 110V Plug & Play

- » Dimensions: 84" x 28"
- » Height: 15"
- » Burning Area: 66" x 10"
- » Weight: 650 lbs.
- » BTU: 65K
- » Sugg. Fire Glass: 100 lbs.

96" Del Mar

OPT-DEL9628 Match Lit
OPT-DEL9628FSML Flame Sense
OPT-DEL9628EKIT 110V Plug & Play

- » Dimensions: 96" x 28"
- » Height: 15"
- » Burning Area: 78" x 10"
- » Weight: 760 lbs.
- » BTU: 65K
- » Sugg. Fire Glass: 100 lbs.

Optional Accessories

Unit	Canvas Cover	Stainless Lid	Glass Wind Guard
48" Del Mar	OPT-CVR-4828	OPT-RC1232	OPT-WG-3414
60" Del Mar	OPT-CVR-6028	OPT-RC1244	OPT-WG-4614
72" Del Mar	OPT-CVR-7228	OPT-RC1256	OPT-WG-5814
84" Del Mar	OPT-CVR-8428	OPT-RC1268	OPT-WG-7014
96" Del Mar	OPT-CVR-9628	OPT-RC1280	OPT-WG-8214



60" GRAY FINISH

Redan Fire Pit

Includes Stainless Steel Door For Propane Tank Storage.

36" x 36" Redan

OPT-RDN36 Match Lit
OPT-RDN36FSML Flame Sense
OPT-RDN36EKIT 110V Plug & Play

- » Dimensions: 36" x 36"
- » Base Dimensions: 24" x 24"
- » Height: 24"
- » Burning Area: 19.5" x 19.5"
- » Weight: 330 lbs.
- » BTU: 45K
- » Sugg. Fire Glass: 75 lbs.

50" x 50" Redan

OPT-RDN50 Match Lit
OPT-RDN50FSML Flame Sense
OPT-RDN50EKIT 110V Plug & Play

- » Dimensions: 50" x 50"
- » Base Dimensions: 36" x 36"
- » Height: 24"
- » Burning Area: 29" x 29"
- » Weight: 455 lbs.
- » BTU: 65K
- » Sugg. Fire Glass: 100 lbs.

Optional Accessories

Unit	Canvas Cover	Stainless Lid	Glass Wind Guard
36" Redan	OPT-CVR-3636	OPT-28SC	OPT-WG-2424
50" Redan	OPT-CVR-5050	OPT-30SC	OPT-WG-3232

Pismo Fire Pit

Includes Stainless Steel Door For Propane Tank Storage.

OPT-2448	Match Lit	OPT-2460	Match Lit
OPT-2448FSML	Flame Sense	OPT-2460FSEN	Flame Sense
OPT-2448EKIT	110V Plug & Play	OPT-2460EKIT	110V Plug & Play

- | | |
|-----------------------------|-----------------------------|
| » Dimension: 48" x 24" | » Dimension: 60" x 24" |
| » Height: 24" | » Height: 24" |
| » Burning Area: 31" x 11" | » Burning Area: 42" x 11" |
| » Toe Kick: 2" x 2" | » Toe Kick: 2" x 2" |
| » Weight: 315 lbs. | » Weight: 395 lbs. |
| » BTU: 65K | » BTU: 65K |
| » Sugg. Fire Glass: 50 lbs. | » Sugg. Fire Glass: 50 lbs. |



Optional Accessories

Unit	Canvas Cover	Stainless Lid	Glass Wind Guard
48" Pismo	OPT-CVR-4824	OPT-RC1232	OPT-WG-3414
60" Pismo	OPT-CVR-6024	OPT-RC1244	OPT-WG-4614

Linear Ramona Fire Table

Includes Stainless Steel Door For Propane Tank Storage.

OPT-RMNR60	Match Lit
OPT-RMNR60FSML	Flame Sense
OPT-RMNR60EKIT	110V Plug & Play

- » Dimensions: 60" x 24"
- » Height: 24"
- » Base: 54" x 18"
- » Burn Area: 48" x 12"
- » Weight: 395 lbs.
- » BTU: 65K
- » Sugg. Fire Glass: 50 lbs.

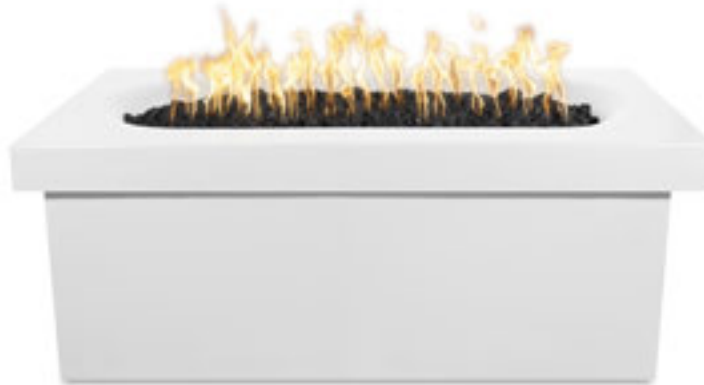

Optional Accessories

Canvas Cover	OPT-CVR-6024
Stainless Steel Lid	OPT-RC1854

Square Ramona Fire Table

Includes Stainless Steel Door For Propane Tank Storage.

OPT-RMNSQ36	Match Lit
OPT-RMNSQ36FSML	Flame Sense
OPT-RMNSQ36EKIT	110V Plug & Play

- » Dimensions: 36" x 36"
- » Height: 24"
- » Base: 30" x 30"
- » Burn Area: 17" x 17"
- » Weight: 355 lbs.
- » BTU: 65K
- » Sugg. Fire Glass: 25 lbs.



Optional Accessories

Canvas Cover	OPT-CVR-3636
Stainless Steel Lid	OPT-24SC

Angelus Fire Pit

Includes Stainless Steel Door For Propane Tank Storage.

OPT-AGLGF60 Match Lit
OPT-AGLGF60FSML Flame Sense
OPT-AGLGF60EKIT 110V Plug & Play

- » Dimensions: 60" x 36"
- » Height: 24"
- » Base: 50" x 24"
- » Burn Area: 48" x 10"
- » Weight: 395 lbs.
- » BTU: 65K
- » Sugg. Fire Glass: 75 lbs.



Optional Accessories

Canvas Cover	OPT-CVR-6036
Stainless Steel Lid	OPT-RC1250
Glass Wind Guard	OPT-WG-5214

Quad Fire Pit

Cannot Store Propane Tank

OPT-QD36 Match Lit
OPT-QD36FSML Flame Sense
OPT-QD36EKIT 110V Plug & Play

OPT-QD42 Match Lit
OPT-QD42FSEN Flame Sense
OPT-QD42EKIT 110V Plug & Play

- | | |
|--|---|
| <ul style="list-style-type: none"> » Dimensions: 36" x 36" » Height: 12" » Burning Area: 28" x 28" » Weight: 180 lbs. » BTU: 65K » Sugg. Fire Glass: 75 lbs. | <ul style="list-style-type: none"> » Dimensions: 42" x 42" » Height: 12" » Burning Area: 34" x 34" » Weight: 215 lbs. » BTU: 65K » Sugg. Fire Glass: 125 lbs. |
|--|---|



Optional Accessories

Unit	Canvas Cover	Stainless Lid	Glass Wind Guard
36" Quad	OPT-CVR-3636	OPT-30SC	OPT-WG-3232
42" Quad	OPT-CVR-4242	OPT-36SC	OPT-WG-3838

Balboa Fire Table - 15" Tall

Cannot Store Propane Tank

OPT-BAL48 Match Lit
OPT-BAL48FSML Flame Sense
OPT-BAL48EKIT 110V Plug & Play

- » Dimensions: 48" x 48"
- » Height: 15"
- » Base: 30" x 30"
- » Burn Area: 19"
- » Weight: 315 lbs.
- » BTU: 65K
- » Sugg. Fire Glass: 25 lbs.



Optional Accessories

Unit	Canvas Cover	Stainless Lid
48" Balboa	OPT-CVR-4848	OPT-28RC

FIRE PITS & FIRE TABLES

All fire pits include: Fire Pan, Burner, Key Valve, Key, Gas Hoses, Lava Rock.
For Match Lit w/ Flame Sense add "-FSML" to part #. For 110V Ignition, add "-EKIT"

36" Cabo Square Fire Pit

OPT-CBSQ36 Match Lit
OPT-CBSQ36FSML Flame Sense
OPT-CBSQ36EKIT 110V Plug & Play

- » Dimensions: 36" x 36" x 16"
- » Base: 24" x 24"
- » Burn Area: 20" x 20" x 2"
- » Weight: 245 lbs.
- » BTU: 65K
- » Sugg. Fire Glass: 50 lbs.

48" Cabo Square Fire Pit

OPT-CBSQ48 Match Lit
OPT-CBSQ48FSML Flame Sense
OPT-CBSQ48EKIT 110V Plug & Play

- » Dimensions: 48" x 48" x 16"
- » Base: 36" x 36"
- » Burn Area: 28" x 28" x 2"
- » Weight: 355 lbs.
- » BTU: 65K
- » Sugg. Fire Glass: 75 lbs.

Optional Accessories For 36" Unit

Canvas Cover	OPT-CVR-3636
Stainless Steel Lid	OPT-22SC
Glass Wind Guard	OPT-WG-2424

Optional Accessories For 48" Unit

Canvas Cover	OPT-CVR-4848
Stainless Steel Lid	OPT-30SC
Glass Wind Guard	OPT-WG-3232



Boston Fire Pillar With Door

OPT-BSTON20AD Match Lit
OPT-BSTON20ADFSML Flame Sense
OPT-BSTON20ADEKIT 110V Plug & Play

Boston Fire Pillar No Door

OPT-BSTON20 Match Lit
OPT-BSTON20FSML Flame Sense
OPT-BSTON20EKIT 110V Plug & Play

- » Dimensions: 20" x 20"
- » Height: 33"
- » Base: 15"
- » Burn Area: 13"
- » Weight: 145 lbs.
- » BTU: 45K
- » Sugg. Fire Glass: 25 lbs.



Optional Accessories

Canvas Cover	OPT-CVR-2020
--------------	--------------

Access door for propane tank optional



Castillo Fire Pillar With Door

OPT-CSTO22AD Match Lit
OPT-CSTO22ADFSML Flame Sense
OPT-CSTO22ADEKIT 110V Plug & Play

Castillo Fire Pillar No Door

OPT-CSTO22 Match Lit
OPT-CSTO22FSML Flame Sense
OPT-CSTO22EKIT 110V Plug & Play

- » Diameter: 22"
- » Height: 33"
- » Base: 13"
- » Burn Area: 18"
- » Weight: 125 lbs.
- » BTU: 45K
- » Sugg. Fire Glass: 25 lbs.



Optional Accessories

Canvas Cover	OPT-CVR-22R
--------------	-------------

Access door for propane tank optional

Metallic Finishes and Rustic Finishes are available at an extra charge

When ordering, specify the concrete color by adding the color code to the end of the Part #. Example: 27" Brown Sedona Water Bowl = OPT-27RWO-BRN

Black -BLK	Ash -ASH	Natural Gray -NGY	Gray -GRY	White Limestone -LIM	Chocolate -CHC	Chestnut -CST	Brown -BRN	Vanilla -VAN
Rustic Gray -RGR	Moss Stone -RMS	Rustic White -RWH	Coffee -RCF	Slate -MSL	Silver -MSV	Pearl -MPR	Bronze -MBR	Copper -MCP

Cabo Linear Fire Pit

OPT-CBLN56 Match Lit
 OPT-CBLN56FSML Flame Sense
 OPT-CBLN56EKIT 110V Plug & Play

- » Dimensions: 56" x 38"
- » Height: 16"
- » Base: 44" x 26"
- » Burn Area: 36" x 14"
- » Weight: 245 lbs.
- » BTU: 65K
- » Sugg. Fire Glass: 75 lbs.

OPT-CBLN66 Match Lit
 OPT-CBLN66FSML Flame Sense
 OPT-CBLN66EKIT 110V Plug & Play

- » Dimensions: 66" x 38"
- » Height: 16"
- » Base: 54" x 26"
- » Burn Area: 36" x 16"
- » Weight: 330 lbs.
- » BTU: 65K
- » Sugg. Fire Glass: 75 lbs.

OPT-CBLN90 Match Lit
 OPT-CBLN90FSML Flame Sense
 OPT-CBLN90EKIT 110V Plug & Play

- » Dimensions: 90" x 38"
- » Height: 16"
- » Base: 78" x 26"
- » Burn Area: 66" x 14"
- » Weight: 435 lbs.
- » BTU: 65K
- » Sugg. Fire Glass: 125 lbs.

Optional Accessories

Unit	Canvas Cover	Stainless Lid	Glass Wind Guard
56" Linear Cabo	OPT-CVR-5638	OPT-RC1838	OPT-WG-4020
66" Linear Cabo	OPT-CVR-6638	OPT-RC1844	OPT-WG-4620
90" Linear Cabo	OPT-CVR-9038	OPT-RC1868	OPT-WG-7020



56" Model Shown - Gray Finish



48" Coronado - Ivory Finish

Coronado Fire Pit

Cannot store propane tank.

MODEL	48" X 28" UNIT	60" X 28" UNIT	72" X 28" UNIT	84" X 28" UNIT	96" X 28" UNIT	108" X 28" UNIT	120" X 28" UNIT
PART # - MATCH-LIT	OPT-COR48	OPT-COR60	OPT-COR72	OPT-COR84	OPT-COR96	OPT-COR108	OPT-COR120
PART # - FLAME SENSE	OPT-COR48FSML	OPT-COR60FSML	OPT-COR72FSML	OPT-COR84FSML	OPT-COR96FSML	OPT-COR108FSML	OPT-COR120FSML
PART # - 110V	OPT-COR48EKIT	OPT-COR60EKIT	OPT-COR72EKIT	OPT-COR84EKIT	OPT-COR96EKIT	OPT-COR108EKIT	OPT-COR120EKIT
HEIGHT	15"	15"	15"	15"	15"	15"	15"
BURN AREA	30" x 10"	42" x 10"	54" x 10"	66" x 10"	78" x 10"	90" x 10"	102" x 10"
TOE KICK	3" x 2"	3" x 2"	3" x 2"	3" x 2"	3" x 2"	3" x 2"	3" x 2"
WEIGHT	235 lbs	375 lbs.	455 lbs.	610 lbs.	690 lbs.	765 lbs.	835 lbs.
BTU	65K	65K	80K	100K	120K	140K	160K
GLASS	50 lbs	50 lbs	75 lbs	100 lbs	100 lbs	125 lbs	125 lbs

Optional Accessories

CANVAS COVER	OPT-CVR-4828	OPT-CVR-6028	OPT-CVR-7228	OPT-CVR-8428	OPT-CVR-9628	OPT-CVR-10828	OPT-CVR-12028
STAINLESS COVER	OPT-RC1232	OPT-RC1244	OPT-RC1256	OPT-RC1268	OPT-RC1280	OPT-RC1292	OPT-RC12104
GLASS WIND GUARD	OPT-WG-3414	OPT-WG-4614	OPT-WG-5814	OPT-WG-7014	OPT-WG-8214	OPT-WG-9414	OPT-WG-10614

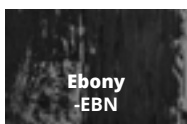

Ebony
-EBN



Ivory
-IVY

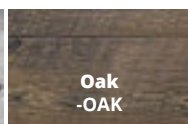

Oak
-OAK

GFRC WOOD GRAIN COLOR OPTIONS

When ordering, specify the color by adding the color code to the end of the Part #.

Example: Coronado Fire Pit in Ivory = OPT-COR48-IVY

FIRE PITS & FIRE TABLES

All fire pits include: Fire Pan, Burner, Key Valve, Key, Gas Hoses, Lava Rock.
For Match Lit w/ Flame Sense add "-FSML" to part #. For 110V Ignition, add "-EKIT"



96" IVORY SHOWN

Catalina Fire Pit

Includes access door for propane tank storage.

MODEL	48" X 28" UNIT	60" X 28" UNIT	72" X 28" UNIT	84" X 28" UNIT	96" X 28" UNIT	108" X 28" UNIT	120" X 28" UNIT
PART # - MATCH-LIT	OPT-CTL48	OPT-CTL60	OPT-CTL72	OPT-CTL84	OPT-CTL96	OPT-CTL108	OPT-CTL120
PART # - FLAME SENSE	OPT-CTL48FSML	OPT-CTL60FSML	OPT-CTL72FSML	OPT-CTL84FSML	OPT-CTL96FSML	OPT-CTL108FSML	OPT-CTL120FSML
PART # - 110V	OPT-CTL48EKIT	OPT-CTL60EKIT	OPT-CTL72EKIT	OPT-CTL84EKIT	OPT-CTL96EKIT	OPT-CTL108EKIT	OPT-CTL120EKIT
HEIGHT	24"	24"	24"	24"	24"	24"	24"
BURN AREA	30" x 10"	42" x 10"	54" x 10"	66" x 10"	78" x 10"	90" x 10"	102" x 10"
TOE KICK	3" x 2"	3" x 2"	3" x 2"	3" x 2"	3" x 2"	3" x 2"	3" x 2"
WEIGHT	375 lbs.	455 lbs.	610 lbs.	690 lbs.	765 lbs.	835 lbs.	910 lbs.
BTU	65K	65K	80K	100K	120K	140K	160K
GLASS	50 lbs	50 lbs	75 lbs	100 lbs	100 lbs	125 lbs	125 lbs

Optional Accessories

CANVAS COVER	OPT-CVR-4828	OPT-CVR-6028	OPT-CVR-7228	OPT-CVR-8428	OPT-CVR-9628	OPT-CVR-10828	OPT-CVR-12028
STAINLESS COVER	OPT-RC1232	OPT-RC1444	OPT-RC1456	OPT-RC1468	OPT-RC1480	OPT-RC1492	OPT-RC14104
GLASS WIND GUARD	OPT-WG-3414	OPT-WG-4616	OPT-WG-5816	OPT-WG-7016	OPT-WG-8216	OPT-WG-9416	OPT-WG-10616



48" Catalina - Ivory Finish



48" Catalina - Oak Finish



72" IVORY SHOWN

Big Sur Collection

Includes access door for 20 lbs propane tank storage

60" x 28" Big Sur Fire Pit

OPT-BGSR60 Match Lit
OPT-BGSR60FSML Flame Sense
OPT-BGSR60EKIT 110V Plug & Play

- » Dimensions: 60" x 28"
- » Height: 24"
- » Burning Area: 42" x 10"
- » Weight: 345 lbs.
- » BTU: 65K
- » Sugg. Fire Glass: 50 lbs.

72" x 28" Big Sur Fire Pit

OPT-BGSR72 Match Lit
OPT-BGSR72FSML Flame Sense
OPT-BGSR72EKIT 110V Plug & Play

- » Dimensions: 72" x 28"
- » Height: 24"
- » Burning Area: 54" x 10"
- » Weight: 425 lbs.
- » BTU: 65K
- » Sugg. Fire Glass: 75 lbs.



Optional Accessories

Unit	Canvas Cover
120" Laguna	OPT-CVR-6028
144" Laguna	OPT-CVR-7228

Square Plymouth Collection - 16" Tall

Does not include door for propane tank storage.

36" x 36" Plymouth Fire Pit

OPT-PLMS36LW Match Lit Ignition
OPT-PLMS36LWFSML Flame Sense
OPT-PLMS36LWEKIT 110V Ignition

48" x 48" Plymouth Fire Pit

OPT-PLMS48LW Match Lit Ignition
OPT-PLMS48LWFSML Flame Sense
OPT-PLMS48LWEKIT 110V Ignition

Square Plymouth Collection - 24" Tall

Includes access door for 20 lbs propane tank storage

36" x 36" Plymouth Fire Pit

OPT-PLMS36 Match Lit Ignition
OPT-PLMS36FSML Flame Sense
OPT-PLMS36EKIT 110V Ignition

48" x 48" Plymouth Fire Pit

OPT-PLMS48 Match Lit Ignition
OPT-PLMS48FSML Flame Sense
OPT-PLMS48EKIT 110V Ignition

- » Dimensions: 36" x 36"
- » Height: 16" / 24"
- » Burn Area: 18"
- » BTUs: 65,000
- » Sugg. Fire Glass: 35 lbs.

- » Dimensions: 48" x 48"
- » Height: 16" / 24"
- » Burn Area: 24"
- » BTUs: 65,000
- » Sugg. Fire Glass: 35 lbs.



Optional Accessories

Unit	Canvas Cover	Stainless Lid	Glass Wind Guard
36" Plymouth	OPT-CVR-3636	OPT-20SC	OPT-WG2222
48" Plymouth	OPT-CVR-4848	OPT-26SC	OPT-WG2828



GFRC WOOD GRAIN COLOR OPTIONS

When ordering, specify the color by adding the color code to the end of the Part #.
Example: Coronado Fire Pit in Ivory = OPT-COR48-IVY

FIRE PITS & FIRE TABLES

All fire pits include: Fire Pan, Burner, Key Valve, Key, Gas Hoses, Lava Rock.
For Match Lit w/ Flame Sense add "-FSML" to part #. For 110V Ignition, add "-EKIT"



Plymouth Collection - 16" Tall

Does not include door for propane tank storage.

48" x 28" Plymouth Fire Pit

OPT-PLM4828LW Match Lit Ignition
OPT-PLM4828LWFSML Flame Sense
OPT-PLM4828LWEKIT 110V Ignition

60" x 28" Plymouth Fire Pit

OPT-PLM6028LW Match Lit Ignition
OPT-PLM6028LWFSML Flame Sense
OPT-PLM6028LWEKIT 110V Ignition

72" x 28" Plymouth Fire Pit

OPT-PLM7228LW Match Lit Ignition
OPT-PLM7228LWFSML Flame Sense
OPT-PLM7228LWEKIT 110V Ignition

84" x 28" Plymouth Fire Pit

OPT-PLM8428LW Match Lit Ignition
OPT-PLM8428LWFSML Flame Sense
OPT-PLM8428LWEKIT 110V Ignition

Plymouth Collection - 24" Tall

Includes access door for 20 lbs propane tank storage

48" x 28" Plymouth Fire Pit

OPT-PLM4828 Match Lit Ignition
OPT-PLM4828FSML Flame Sense
OPT-PLM4828EKIT 110V Ignition

60" x 28" Plymouth Fire Pit

OPT-PLM6028 Match Lit Ignition
OPT-PLM6028FSML Flame Sense
OPT-PLM6028EKIT 110V Ignition

72" x 28" Plymouth Fire Pit

OPT-PLM7228 Match Lit Ignition
OPT-PLM7228FSML Flame Sense
OPT-PLM7228EKIT 110V Ignition

84" x 28" Plymouth Fire Pit

OPT-PLM8428 Match Lit Ignition
OPT-PLM8428FSML Flame Sense
OPT-PLM8428EKIT 110V Ignition

- » Dimensions: 48" x 28"
- » Height: 16" / 24"
- » Base Dimensions: 38" x 18"
- » Burn Area: 30" x 10"
- » BTUs: 40,000
- » Sugg. Fire Glass: 35 lbs.

- » Dimensions: 60" x 28"
- » Height: 16" / 24"
- » Base Dimensions: 50" x 18"
- » Burn Area: 42" x 10"
- » BTUs: 50,000
- » Sugg. Fire Glass: 35 lbs.

- » Dimensions: 72" x 28"
- » Height: 16" / 24"
- » Base Dimensions: 62" x 18"
- » Burn Area: 54" x 10"
- » BTUs: 60,000
- » Sugg. Fire Glass: 35 lbs.

- » Dimensions: 84" x 28"
- » Height: 16" / 24"
- » Base Dimensions: 74" x 18"
- » Burn Area: 66" x 10"
- » BTUs: 70,000
- » Sugg. Fire Glass: 35 lbs.

Optional Accessories

Unit	Canvas Cover	Stainless Lid	Glass Wind Guard
48" Plymouth	OPT-CVR-4828	OPT-1232	OPT-WG-3414
60" Plymouth	OPT-CVR-6028	OPT-1244	OPT-WG-4614
72" Plymouth	OPT-CVR-7228	OPT-1256	OPT-WG-5814
84" Plymouth	OPT-CVR-8428	OPT-1268	OPT-WG-7014



48" Plymouth - Ebony Finish



Alberta Fire Pit

Includes access door for 20 lbs propane tank storage

OPT-ALB36 Match Lit
OPT-ALB36FSML Flame Sense
OPT-ALB36EKIT 110V Plug & Play

- » Dimensions: 36" x 24"
- » Base: 24" x 18"
- » Height: 23"
- » Burning Area: 20" x 8" x 2"
- » Weight: 150 lbs.
- » BTU: 65K
- » Sugg. Fire Glass: 25 lbs.



Optional Accessories

Canvas Cover	OPT-CVR-3624
Stainless Steel Lid	OPT-RC1022
Glass Wind Guard	OPT-WG-2412



OAK FINISH SHOWN

Palo Collection

Does not include door for propane tank storage.

48" Palo Fire Pit

OPT-PAL48 Match Lit
OPT-PAL48FSML Flame Sense
OPT-PAL48EKIT 110V Plug & Play

- » Dimensions: 48" x 29"
- » Height: 17"
- » Burning Area: 20" x 8" x 2"
- » Weight: 355 lbs.
- » BTU: 20K
- » Sugg. Fire Glass: 20 lbs.

60" Palo Fire Pit

OPT-PAL60 Match Lit
OPT-PAL60FSML Flame Sense
OPT-PAL60EKIT 110V Plug & Play

- » Dimensions: 60" x 29"
- » Height: 17"
- » Burning Area: 32" x 8" x 2"
- » Weight: 495 lbs.
- » BTU: 25K
- » Sugg. Fire Glass: 30 lbs.



48" OAK FINISH SHOWN

Optional Accessories

Unit	Canvas Cover	Stainless Lid	Glass Wind Guard
48" Palo	OPT-CVR-4828	OPT-RC1022	OPT-WG-2414
60" Palo	OPT-CVR-6028	OPT-RC1034	OPT-WG-3614

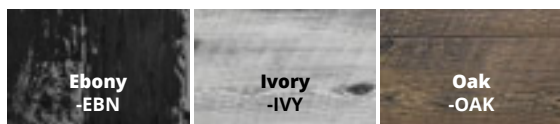

GFRC WOOD GRAIN COLOR OPTIONS

When ordering, specify the color by adding the color code to the end of the Part #.
Example: Coronado Fire Pit in Ivory = OPT-COR48-IVY

FIRE PITS & FIRE TABLES

All fire pits include: Fire Pan, Burner, Key Valve, Key, Gas Hoses, Lava Rock.
For Match Lit w/ Flame Sense add "-FSML" to part #. For 110V Ignition, add "-EKIT"



Carson Collection - 16" Tall

Does not include door for propane tank storage.

48" x 36" Carson Fire Pit

OPT-CRS4836LW Match Lit Ignition
OPT-CRS4836LWFSML Flame Sense
OPT-CRS4836LWEKIT 110V Ignition

60" x 36" Carson Fire Pit

OPT-CRS6036LW Match Lit Ignition
OPT-CRS6036LWFSML Flame Sense
OPT-CRS6036LWEKIT 110V Ignition

72" x 36" Carson Fire Pit

OPT-CRS7236LW Match Lit Ignition
OPT-CRS7236LWFSML Flame Sense
OPT-CRS7236LWEKIT 110V Ignition

84" x 36" Carson Fire Pit

OPT-CRS8436LW Match Lit Ignition
OPT-CRS8436LWFSML Flame Sense
OPT-CRS8436LWEKIT 110V Ignition

Carson Collection - 24" Tall

Includes access door for 20 lbs propane tank storage

48" x 36" Carson Fire Pit

OPT-CRS4836 Match Lit Ignition
OPT-CRS4836FSML Flame Sense
OPT-CRS4836EKIT 110V Ignition

- » Dimensions: 48" x 36"
- » Height: 16" / 24"
- » Base Dimensions: 32" x 18"
- » Overhang: 4"
- » Burning Area: 30" x 8"
- » BTUs: 40,000
- » Suggested Fire Glass: 25 lbs.

60" x 36" Carson Fire Pit

OPT-CRS6036 Match Lit Ignition
OPT-CRS6036FSML Flame Sense
OPT-CRS6036EKIT 110V Ignition

- » Dimensions: 60" x 36"
- » Height: 16" / 24"
- » Base Dimensions: 44" x 18"
- » Overhang: 4"
- » Burning Area: 42" x 8"
- » BTUs: 60,000
- » Suggested Fire Glass: 35 lbs.

72" x 36" Carson Fire Pit

OPT-CRS7236 Match Lit Ignition
OPT-CRS7236FSML Flame Sense
OPT-CRS7236EKIT 110V Ignition

- » Dimensions: 72" x 36"
- » Height: 16" / 24"
- » Base Dimensions: 56" x 18"
- » Overhang: 4"
- » Burning Area: 54" x 8"
- » BTUs: 80,000
- » Suggested Fire Glass: 50 lbs.

84" x 36" Carson Fire Pit

OPT-CRS8436 Match Lit Ignition
OPT-CRS8436FSML Flame Sense
OPT-CRS8436EKIT 110V Ignition

- » Dimensions: 84" x 36"
- » Height: 16" / 24"
- » Base Dimensions: 68" x 18"
- » Overhang: 4"
- » Burning Area: 66" x 8"
- » BTUs: 140,000
- » Suggested Fire Glass: 60 lbs.

Optional Accessories

Unit	Canvas Cover	Stainless Lid	Glass Wind Guard
48" Carson	OPT-CVR-4836	OPT-1032	OPT-WG-3412
60" Carson	OPT-CVR-6036	OPT-1044	OPT-WG-4612
72" Carson	OPT-CVR-7236	OPT-1056	OPT-WG-5812
84" Carson	OPT-CVR-8436	OPT-1068	OPT-WG-7012





120" IVORY SHOWN

Laguna Collection

Includes access door for 20lb propane tank storage.

120" x 60" Laguna Fire Table

OPT-LGNGF120 Match Lit
OPT-LGNGF120FSML Flame Sense
OPT-LGNGF120EKIT 110V Plug & Play

- » Dimensions: 120" x 60"
- » Height: 42"
- » Burning Area: 78" x 12"
- » Overhang: 12"
- » Weight: 1465 lbs.
- » BTU: 120K
- » Sugg. Fire Glass: 125 lbs.

144" x 60" Laguna Fire Table

OPT-LGNGF144 Match Lit
OPT-LGNGF144FSML Flame Sense
OPT-LGNGF144EKIT 110V Plug & Play

- » Dimensions: 144" x 60"
- » Height: 42"
- » Burning Area: 102" x 12"
- » Overhang: 12"
- » Weight: 1750 lbs.
- » BTU: 160K
- » Sugg. Fire Glass: 175 lbs.



Optional Accessories

Unit	Canvas Cover	Stainless Lid	Glass Wind Guard
120" Laguna	OPT-CVR-12060	OPT-RC1480	OPT-WG-8216
144" Laguna	OPT-CVR-14460	OPT-RC114104	OPT-WG-10616

The Grove Fire Table

Includes access door for 20lb propane tank storage.

OPT-GRVWG60 Match Lit
OPT-GRVWG60FSML Flame Sense
OPT-GRVWG60EKIT 110V Plug & Play

- » Dimensions: 60" x 28"
- » Height: 24"
- » Base Dimensions: 48" x 22"
- » Burning Area: 30" x 10"
- » Weight: 235 lbs.
- » BTU: 65K
- » Sugg. Fire Glass: 50 lbs.



Optional Accessories

Canvas Cover	OPT-CVR-6028
Stainless Steel Lid	OPT-RC1232
Glass Wind Guard	OPT-WG-3414



GFRC WOOD GRAIN COLOR OPTIONS

When ordering, specify the color by adding the color code to the end of the Part #.
Example: Coronado Fire Pit in Ivory = OPT-COR48-IVY

FIRE PITS & FIRE TABLES

All fire pits include: Fire Pan, Burner, Key Valve, Key, Gas Hoses, Lava Rock.
For Match Lit w/ Flame Sense add "-FSML" to part #. For 110V Ignition, add "-EKIT"



78" WOOD GRAIN IVORY FINISH SHOWN

Alameda Collection

Includes 2 access doors for LP tank storage.
Glass Wind Guard Not Included.

60" Wood Grain Concrete Top

OPT-ALMWG60	Match Lit
OPT-ALMWG60FSML	Flame Sense
OPT-ALMWG60EKIT	110V Plug & Play

60" Smooth Concrete Top

OPT-ALMGFRC60	Match Lit
OPT-ALMGFRC60FSML	Flame Sense
OPT-ALMGFRC60KIT	110V Plug & Play

- » Dimensions: 60" x 28"
- » Base Dimensions: 52" x 20"
- » Height: 30"
- » Burning Area: 30" x 10"
- » Weight: 150 lbs.
- » BTU: 65K
- » Sugg. Fire Glass: 30 lbs.

78" Wood Grain Concrete Top

OPT-ALMWG78	Match Lit
OPT-ALMWG78EKIT	110V Plug & Play
OPT-ALMWG78FSML	Flame Sense

78" Smooth Concrete Top

OPT-ALMGFRC78	Match Lit
OPT-ALMGFRC7FSML	Flame Sense
OPT-ALMGFRC78KIT	110V Plug & Play

- » Dimensions: 78" x 36"
- » Base Dimensions: 70" x 24"
- » Height: 30"
- » Burning Area: 48" x 10"
- » Weight: 200 lbs.
- » BTU: 65K
- » Sugg. Fire Glass: 50 lbs.

Optional Accessories

Unit	Canvas Cover	Stainless Lid	Glass Wind Guard
60" x 28" Alameda	OPT-CVR-6028	OPT-RC1232	OPT-WG-3614
78" x 28" Alameda	OPT-CVR-7836	OPT-RC1250	OPT-WG-5214

MATERIAL OPTIONS

- » Powder coated top options found on page 81
- » Corten steel option found on page 90



Tacoma Fire Table

Includes access door for 20lb propane tank storage.

OPT-TACW4830	Match Lit
OPT-TACW4830FSML	Flame Sense
OPT-TACW4830EKIT	110V Plug & Play

- » Dimensions: 48" x 30"
- » Height: 24"
- » Base Dimensions: 33" x 18"
- » Overhang: 4"
- » Burning Area: 30" x 8"
- » BTUs: 65,000
- » Suggested Fire Glass: 25 lbs.



Optional Accessories

Canvas Cover	OPT-CVR-4830
Stainless Steel Lid	OPT-RC1032
Glass Wind Guard	OPT-WG-3412

Fresno Collection

Includes door for propane tank storage

43" Fresno Fire Table

OPT-FRS43 Match Lit Ignition
OPT-FRS43FSML Flame Sense
OPT-FRS43EKIT 110V Ignition

- » Diameter: 43"
- » Base Diameter: 24"
- » Height: 24"
- » Burning Area: 19"
- » Weight: 285 lbs.
- » BTU: 65K
- » Sugg. Fire Glass: 30 lbs.



Ivory Top & Black Base
OPT-FRS43-IVYBLK

60" Fresno Fire Table

OPT-FRS60 Match Lit Ignition
OPT-FRS60FSML Flame Sense
OPT-FRS60EKIT 110V Ignition

- » Diameter: 60"
- » Base Diameter: 24"
- » Height: 24"
- » Burning Area: 31"
- » Weight: 285 lbs.
- » BTU: 65K
- » Sugg. Fire Glass: 30 lbs.



Ivory Top & Java Base
OPT-FRS43-IVYJAV



Oak Top & Java Base
OPT-FRS43-OAKJAV



Ivory Top & Java Base
OPT-FRS43-OAKBLK

Optional Accessories

Unit	Canvas Cover	Stainless Lid
43" Fresno	OPT-CVR-43R	OPT-23RC
60" Fresno	OPT-CVR-60R	OPT-29RC



Sequoia Collection - 16" Tall

Does not include door for propane tank storage.

42" Sequoia Fire Pit

OPT-SEQ42LW Match Lit Ignition
OPT-SEQ42LWFSML Flame Sense
OPT-SEQ42LWEKIT 110V Ignition

- » Diameter: 42"
- » Height: 16"
- » Burn Area: 19"
- » BTUs: 65,000
- » Sugg. Fire Glass: 30 lbs.

60" Sequoia Fire Pit

OPT-SEQ60LW Match Lit Ignition
OPT-SEQ60LWFSML Flame Sense
OPT-SEQ60LWEKIT 110V Ignition

- » Diameter: 60"
- » Height: 16"
- » Burn Area: 31"
- » BTUs: 65,000
- » Sugg. Fire Glass: 30 lbs.

Optional Accessories

Unit	Canvas Cover	Stainless Lid
42" Sequoia	OPT-CVR-42R	OPT-23RC
60" Sequoia	OPT-CVR-60R	OPT-35RC

Sequoia Collection - 24" Tall

Includes access door for 20lb propane tank storage.



42" Sequoia Fire Pit

OPT-SEQ42 Match Lit Ignition
OPT-SEQ42FSML Flame Sense
OPT-SEQ42EKIT 110V Ignition

- » Diameter: 42"
- » Height: 24"
- » Burn Area: 19"
- » BTUs: 65,000
- » Sugg. Fire Glass: 30 lbs.

60" Sequoia Fire Pit

OPT-SEQ60 Match Lit Ignition
OPT-SEQ60FSML Flame Sense
OPT-SEQ60EKIT 110V Ignition

- » Diameter: 60"
- » Height: 24"
- » Burn Area: 31"
- » BTUs: 65,000
- » Sugg. Fire Glass: 30 lbs.



42" (16" - Tall) Oak Finish



Redan Copper Collection

Includes access door for 20lb propane tank storage.



36" x 36" Redan Fire Pit

OPT-SQ36CPM Match Lit Ignition
OPT-SQ36CPMFSML Flame Sense
OPT-SQ36CPMEKIT 110V Ignition

- » Dimensions: 36" x 36"
- » Height: 24"
- » Base: 30" x 30"
- » Burning Area: 20" x 20" x 2"
- » Weight: 120 lbs.
- » BTU: 65K
- » Sugg. Fire Glass: 50 lbs.

48" x 48" Redan Fire Pit

OPT-SQ48CPM Match Lit Ignition
OPT-SQ48CPMFSML Flame Sense
OPT-SQ48CPMEKIT 110V Ignition

- » Dimensions: 48" x 48"
- » Height: 24"
- » Base: 36" x 36"
- » Burning Area: 24" x 24" x 2"
- » Weight: 155 lbs.
- » BTU: 65K
- » Sugg. Fire Glass: 75 lbs.



Optional Accessories

Unit	Canvas Cover	Stainless Lid	Glass Wind Guard
36" Redan	OPT-CVR-3636	OPT-22SC	OPT-WG-2424
48" Redan	OPT-CVR-4848	OPT-26SC	OPT-WG-2828

Vista Copper Fire Pit

Includes door for propane tank storage



OPT-FPT2500 Match Lit Ignition
OPT-FPT2500FSML Flame Sense
OPT-FPT2500EKIT 110V Ignition

- » Dimensions: 24" x 24"
- » Base Dimensions: 16" x 16"
- » Height: 24"
- » Burning Area: 16" x 16" x 2"
- » Weight: 165 lbs.
- » BTU: 65K
- » Sugg. Fire Glass: 25 lbs.
- » Material: Copper
- » Finish: Patina Copper



Optional Accessories

Canvas Cover	OPT-CVR-2424
Stainless Steel Lid	OPT-18SC

Quad Copper Collection

Does not include door for propane tank storage



36" x 36" Quad Fire Pit

OPT-QDCPR36 Match Lit Ignition
OPT-QDCPR36FSML Flame Sense
OPT-QDCPR36EKIT 110V Ignition

- » Dimensions: 36" x 36"
- » Height: 15"
- » Burning Area: 18" x 18" x 2"
- » Weight: 90 lbs.
- » BTU: 65K
- » Sugg. Fire Glass: 50 lbs.
- » Material: Copper
- » Finish: Hammered Patina Copper

42" x 42" Quad Fire Pit

OPT-QDCPR42 Match Lit Ignition
OPT-QDCPR42FSML Flame Sense
OPT-QDCPR42EKIT 110V Ignition

- » Dimensions: 42" x 42"
- » Height: 15"
- » Burning Area: 24" x 24" x 2"
- » Weight: 105 lbs.
- » BTU: 65K
- » Sugg. Fire Glass: 75 lbs.
- » Material: Copper
- » Finish: Hammered Patina Copper

Optional Accessories

Unit	Canvas Cover	Stainless Lid	Glass Wind Guard
36" Quad	OPT-CVR-3636	OPT-20SC	OPT-WG-2222
42" Quad	OPT-CVR-4242	OPT-26SC	OPT-WG-2828

FIRE PITS & FIRE TABLES

All fire pits include: Fire Pan, Burner, Key Valve, Key, Gas Hoses, Lava Rock.
For Match Lit w/ Flame Sense add "-FSML" to part #. For 110V Ignition, add "-EKIT"



48" Cazo Copper Fire Pit - Narrow Ledge

Does not Include door for propane tank storage

OPT-RHC48 Match Lit Ignition
OPT-RHC48FSML Flame Sense
OPT-RHC48EKIT 110V Ignition

- » Diameter: 48
- » Base Diameter: 18"
- » Height: 15"
- » Burning Area: 40"
- » Weight: 185 lbs.
- » BTU: 65K
- » Sugg. Fire Glass: 150 lbs.
- » Material: Copper
- » Finish: Patina Copper

Optional Accessories

Canvas Cover	OPT-CVR-48R
Stainless Steel Lid	OPT-44RC



48" Cazo Copper Fire Pit - Wide Ledge

Does not Include door for propane tank storage

OPT-RS48 Match Lit Ignition
OPT-RS48FSML Flame Sense
OPT-RS48EKIT 110V Ignition

- » Diameter: 48"
- » Base Diameter: 18"
- » Height: 15"
- » Burning Area: 24"
- » Weight: 185 lbs.
- » BTU: 65K
- » Sugg. Fire Glass: 50 lbs.
- » Material: Copper
- » Finish: Patina Copper

Optional Accessories

Canvas Cover	OPT-CVR-48R
Stainless Steel Lid	OPT-26RC



Martillo Copper Fire Pit

Includes door for propane tank storage

OPT-48RM Match Lit Ignition
OPT-48RMFSML Flame Sense
OPT-48RMEKIT 110V Ignition

- » Diameter: 48"
- » Height: 24"
- » Base Diameter: 30"
- » Burning Area: 24"
- » Weight: 105 lbs.
- » BTU: 65K
- » Sugg. Fire Glass: 50 lbs.
- » Material: Copper



Optional Accessories

Canvas Cover	OPT-CVR-48R
Stainless Steel Lid	OPT-26RC

Eaves Collection

Eaves Fire Pits cannot store propane tank.

48" x 10" Eaves

OPT-LBTCPR48	Hammered Copper
OPT-LBTC548	Corten Steel
OPT-LBTSS48	Stainless Steel
OPT-LBTPC48	Powder Coat

- » Dimensions: 48" x 10"
- » Height: 10"
- » Burn Area: 44" x 6"
- » Weight: 315 lbs.
- » BTU: 65K
- » Sugg. Fire Glass: 30 lbs.



48" HAMMERED COPPER

60" x 10" Eaves

OPT-LBTCPR60	Hammered Copper
OPT-LBTC60	Corten Steel
OPT-LBTSS60	Stainless Steel
OPT-LBTPC60	Powder Coat

- » Dimensions: 60" x 10"
- » Height: 10"
- » Burning Area: 56" x 6"
- » Weight: 85 Lbs.
- » BTU: 65K
- » Sugg. Fire Glass: 50 lbs.



60" CORTEN STEEL

72" x 10" Eaves

OPT-LBTCPR72	Hammered Copper
OPT-LBTC572	Corten Steel
OPT-LBTSS72	Stainless Steel
OPT-LBTPC72	Powder Coat

- » Dimensions: 72" x 10"
- » Height: 10"
- » Burn Area: 68" x 6"
- » Weight: 315 lbs.
- » BTU: 65K
- » Sugg. Fire Glass: 50 lbs.



48" STAINLESS STEEL

Optional Accessories

Unit	Canvas Cover	Stainless Lid
48" Eaves	OPT-CVR-4810	OPT-RC1048
60" Eaves	OPT-CVR-6010	OPT-RC1060
72" Eaves	OPT-CVR-7210	OPT-RC1072



60" SILVER VEIN POWDER COAT

POWDER COAT COLOR OPTIONS

When ordering, specify the powder coat color by adding the color code to the end of the Part #. **Example:** White Coronado Fire Pit = OPT-CORPC48-WHT

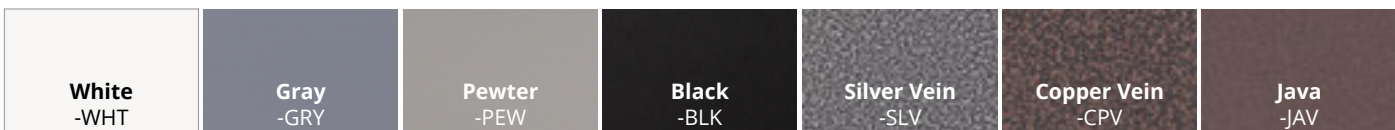

FIRE PITS & FIRE TABLES

All fire pits include: Fire Pan, Burner, Key Valve, Key, Gas Hoses, Lava Rock.
For Match Lit w/ Flame Sense add "-FSML" to part #. For 110V Ignition, add "-EKIT"



HAMMERED COPPER



GRAY POWDER COAT - 16" TALL



STAINLESS STEEL



CORTEN STEEL

Carmen Collection

72" x 16" Carmen- 16" Tall

Cannot store propane tank.

OPT-CRMCP7216 Hammered Copper
OPT-CRMCS7216 Corten Steel
OPT-CRMSS7216 Stainless Steel
OPT-CRMPC7216 Powder Coat

- » Dimensions: 72" x 16"
- » Height: 16"
- » Burn Area: 54" x 8"
- » Weight: 215 lbs.
- » BTU: 65K
- » Suggested Fire Glass: 50 lbs.

72" x 16" Carmen- 24" Tall

Includes door for propane tank storage

OPT-CRMCP7224 Hammered Copper
OPT-CRMCS7224 Corten Steel
OPT-CRMSS7224 Stainless Steel
OPT-CRMPC7224 Powder Coat

- » Dimensions: 72" x 16"
- » Height: 24"
- » Burn Area: 54" x 8"
- » Weight: 215 lbs.
- » BTU: 65K
- » Suggested Fire Glass: 50 lbs.



Optional Accessories

Canvas Cover	OPT-CVR-7216
Stainless Steel Cover	OPT-RC1056
Glass Wind Guard	OPT-WG-5812

Eaves & Carmen

48" x 10" Eaves (left)
72" x 16" Carmen (middle)
72" x 24" Carmen (right)



FIRE PITS & FIRE TABLES

All fire pits include: Fire Pan, Burner, Key Valve, Key, Gas Hoses, Lava Rock.
For Match Lit w/ Flame Sense add "-FSML" to part #. For 110V Ignition, add "-EKIT"



72" HAMMERED COPPER



CORTEN STEEL



STAINLESS STEEL



POWDER COAT SILVER VEIN

Mesa Collection

Includes access door for 20 lbs propane tank storage

48" x 24" Mesa

OPT-CPRTT4824 Hammered Copper
OPT-CSTT4824 Corten Steel
OPT-SSTT4824 Stainless Steel
OPT-PCTT4824 Powder Coat

- » Dimensions: 48" x 24"
- » Height: 24"
- » Base: 36" x 18"
- » Burning Area: 36" x 12" x 2"
- » Weight: 120 lbs.
- » BTU: 65K
- » Sugg. Fire Glass: 50 lbs.

60" x 24" Mesa

OPT-CPRTT6024 Hammered Copper
OPT-CSTT6024 Corten Steel
OPT-SSTT6024 Stainless Steel
OPT-PCTT6024 Powder Coat

- » Dimensions: 60" x 24"
- » Height: 24"
- » Base: 48" x 18"
- » Burning Area: 48" x 12" x 2"
- » Weight: 180 lbs.
- » BTU: 65K
- » Sugg. Fire Glass: 75 lbs.

72" x 24" Mesa

OPT-CPRTT7224 Hammered Copper
OPT-CSTT7224 Corten Steel
OPT-SSTT7224 Stainless Steel
OPT-PCTT7224 Powder Coat

- » Dimensions: 72" x 24"
- » Height: 24"
- » Base: 60" x 18"
- » Burning Area: 60" x 12" x 2"
- » Weight: 240 lbs.
- » BTU: 65K
- » Sugg. Fire Glass: 75 lbs.

84" x 24" Mesa

OPT-CPRTT8424 Hammered Copper
OPT-CSTT8424 Corten Steel
OPT-SSTT8424 Stainless Steel
OPT-PCTT8424 Powder Coat

- » Dimensions: 84" x 24"
- » Height: 24"
- » Base: 72" x 18"
- » Burning Area: 72" x 12" x 2"
- » Weight: 315 lbs.
- » BTU: 65K
- » Sugg. Fire Glass: 50 lbs.

Optional Accessories

Unit	Canvas Cover	Stainless Lid	Glass Wind Guard
48" Mesa	OPT-CVR-4824	OPT-RC1438	OPT-WG-4016
60" Mesa	OPT-CVR-6024	OPT-RC1450	OPT-WG-5216
72" Mesa	OPT-CVR-7224	OPT-RC1462	OPT-WG-6416
84" Mesa	OPT-CVR-8424	OPT-RC1474	OPT-WG-7616



FIRE PITS & FIRE TABLES

All fire pits include: Fire Pan, Burner, Key Valve, Key, Gas Hoses, Lava Rock.
For Match Lit w/ Flame Sense add "-FSML" to part #. For 110V Ignition, add "-EKIT"



60" HAMMERED COPPER



48" STAINLESS STEEL

Pismo Collection

Includes access door for 20 lbs propane tank storage

48" x 24" Pismo

OPT-CPRT4824 Hammered Copper
OPT-R4824CS Corten Steel
OPT-R4824SS Stainless Steel
OPT-R4824PCR Powder Coat

- » Dimensions: 48" x 24"
- » Height: 24"
- » Burning Area: 36" x 12" x 2"
- » Weight: 135 lbs.
- » BTU: 65K
- » Sugg. Fire Glass: 50 lbs.

60" x 24" Pismo

OPT-CPRT6024 Hammered Copper
OPT-R6024CS Corten Steel
OPT-R6024SS Stainless Steel
OPT-R6024PCR Powder Coat

- » Dimensions: 60" x 24"
- » Height: 24"
- » Burning Area: 48" x 12" x 2"
- » Weight: 180 lbs.
- » BTU: 65K
- » Sugg. Fire Glass: 75 lbs.

72" x 24" Pismo

OPT-CPRT7224 Hammered Copper
OPT-R7224CS Corten Steel
OPT-R7224SS Stainless Steel
OPT-R7224PCR Powder Coat

- » Dimensions: 72" x 24"
- » Height: 24"
- » Burning Area: 60" x 12" x 2"
- » Weight: 215 lbs.
- » BTU: 80K
- » Sugg. Fire Glass: 75 lbs.

84" x 24" Pismo

OPT-CPRT8424 Hammered Copper
OPT-R8424CS Corten Steel
OPT-R8424SS Stainless Steel
OPT-R8424PCR Powder Coat

- » Dimensions: 84" x 24"
- » Height: 24"
- » Burning Area: 72" x 12" x 2"
- » Weight: 260 lbs.
- » BTU: 100K
- » Sugg. Fire Glass: 100 lbs.

Optional Accessories

Unit	Canvas Cover	Stainless Lid	Glass Wind Guard
48" Pismo	OPT-CVR-4824	OPT-RC1438	OPT-WG-4016
60" Pismo	OPT-CVR-6024	OPT-RC1450	OPT-WG-5216
72" Pismo	OPT-CVR-7224	OPT-RC1462	OPT-WG-6416
84" Pismo	OPT-CVR-8424	OPT-RC1474	OPT-WG-7616

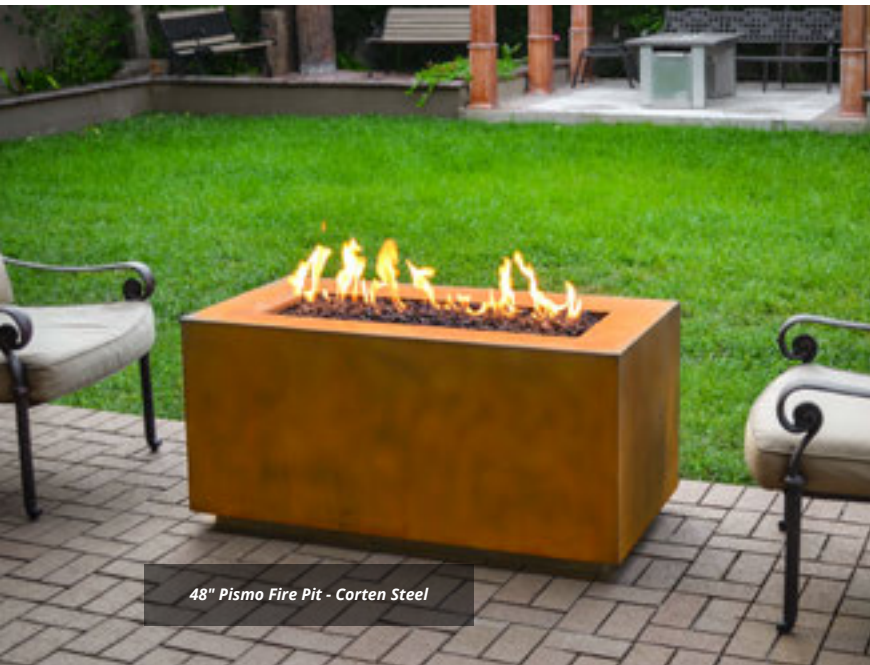

48" Pismo Fire Pit - Corten Steel



48" Pismo Fire Pit - White Powder Coat Finish

Coronado Collection

Cannot store propane tank.
Powder coated units have a visible stainless steel lip around the burn area



CORTEN STEEL

48" x 28" Coronado Fire Pit

OPT-CORCPR48 Hammered Copper
OPT-CORCS48 Corten Steel
OPT-CORSS48 Stainless Steel
OPT-CORPC48 Powder Coat

- » Dimensions: 48" x 28"
- » Height: 15"
- » Base: 38" x 18"
- » Burning Area: 30" x 10" x 2"
- » Weight: 175 lbs.
- » BTU: 45K
- » Sugg. Fire Glass: 50 lbs.

60" x 28" Coronado Fire Pit

OPT-CORCPR60 Hammered Copper
OPT-CORCS60 Corten Steel
OPT-CORSS60 Stainless Steel
OPT-CORPC60 Powder Coat

- » Dimensions: 60" x 28"
- » Height: 15"
- » Base: 50" x 18"
- » Burning Area: 42" x 10" x 2"
- » Weight: 195 lbs.
- » BTU: 65K
- » Sugg. Fire Glass: 50 lbs.



STAINLESS STEEL

72" x 28" Coronado Fire Pit

OPT-CORCPR72 Hammered Copper
OPT-CORCS72 Corten Steel
OPT-CORSS72 Stainless Steel
OPT-CORPC72 Powder Coat

- » Dimensions: 72" x 28"
- » Height: 15"
- » Base: 62" x 18"
- » Burning Area: 54" x 10" x 2"
- » Weight: 220 lbs.
- » BTU: 65K
- » Sugg. Fire Glass: 75 lbs.

84" x 28" Coronado Fire Pit

OPT-CORCPR84 Hammered Copper
OPT-CORCS84 Corten Steel
OPT-CORSS84 Stainless Steel
OPT-CORPC84 Powder Coat

- » Dimensions: 84" x 28"
- » Height: 15"
- » Base: 74" x 18"
- » Burning Area: 66" x 10" x 2"
- » Weight: 245 lbs.
- » BTU: 65K
- » Sugg. Fire Glass: 75 lbs.



BLACK POWDER COAT

96" x 28" Coronado Fire Pit

OPT-CORCPR96 Hammered Copper
OPT-CORCS96 Corten Steel
OPT-CORSS96 Stainless Steel
OPT-CORPC96 Powder Coat

- » Dimensions: 96" x 28"
- » Height: 15"
- » Base: 86" x 18"
- » Burning Area: 78" x 10" x 2"
- » Weight: 270 lbs.
- » BTU: 65K
- » Sugg. Fire Glass: 100 lbs.

108" x 28" Coronado Fire Pit

OPT-CORCPR108 Hammered Copper
OPT-CORCS108 Corten Steel
OPT-CORSS108 Stainless Steel
OPT-CORPC108 Powder Coat

- » Dimensions: 108" x 28"
- » Height: 15"
- » Base: 98" x 18"
- » Burning Area: 90" x 10" x 2"
- » Weight: 320 lbs.
- » BTU: 65K
- » Sugg. Fire Glass: 100 lbs.

Optional Accessories

Unit	Canvas Cover	Stainless Lid	Glass Wind Guard
48" Coronado	OPT-CVR-4828	OPT-RC1232	OPT-WG-3414
60" Coronado	OPT-CVR-6028	OPT-RC1244	OPT-WG-4614
72" Coronado	OPT-CVR-7228	OPT-RC1256	OPT-WG-5814
84" Coronado	OPT-CVR-8428	OPT-RC1268	OPT-WG-7014
96" Coronado	OPT-CVR-9628	OPT-RC1280	OPT-WG-8214
108" Coronado	OPT-CVR-10828	OPT-RC1292	OPT-WG-9414



108" HAMMERED COPPER

FIRE PITS & FIRE TABLES

All fire pits include: Fire Pan, Burner, Key Valve, Key, Gas Hoses, Lava Rock.
For Match Lit w/ Flame Sense add "-FSML" to part #. For 110V Ignition, add "-EKIT"



CORTEN STEEL



STAINLESS STEEL



SILVER VEIN POWDER COAT



HAMMERED COPPER

Forma Collection

Includes door for propane tank storage.
Powder coated units have a visible stainless steel lip around the burn area

30" Forma Fire Pit

OPT-3030SQ CPR Hammered Copper
OPT-3030SQ CS Corten Steel
OPT-3030SQ SS Stainless Steel
OPT-30PCSQ Powder Coat

- » Dimensions: 30" x 30"
- » Height: 24"
- » Burning Area: 18" x 18" x 2"
- » Weight: 70 lbs.
- » BTU: 65K
- » Sugg. Fire Glass: 25 lbs.

36" Forma Fire Pit

OPT-3636SQ CPR Hammered Copper
OPT-3636SQ CS Corten Steel
OPT-3636SQ SS Stainless Steel
OPT-36PCSQ Powder Coat

- » Dimensions: 36" x 36"
- » Height: 24"
- » Burning Area: 24" x 24" x 2"
- » Weight: 90 lbs.
- » BTU: 65K
- » Sugg. Fire Glass: 50 lbs.

42" Forma Fire Pit

OPT-4242SQ CPR Hammered Copper
OPT-4242SQ CS Corten Steel
OPT-4242SQ SS Stainless Steel
OPT-42PCSQ Powder Coat

- » Dimensions: 42" x 42"
- » Height: 24"
- » Burning Area: 30" x 30" x 2"
- » Weight: 105 lbs.
- » BTU: 65K
- » Sugg. Fire Glass: 94 lbs.

48" Forma Fire Pit

OPT-4848SQ CPR Hammered Copper
OPT-4848SQ CS Corten Steel
OPT-4848SQ SS Stainless Steel
OPT-48PCSQ Powder Coat

- » Dimensions: 48" x 48"
- » Height: 24"
- » Burning Area: 36" x 36" x 2"
- » Weight: 155 lbs.
- » BTU: 65K
- » Sugg. Fire Glass: 135 lbs.

60" Forma Fire Pit

OPT-6060SQ CPR Hammered Copper
OPT-6060SQ CS Corten Steel
OPT-6060SQ SS Stainless Steel
OPT-60PCSQ Powder Coat

- » Dimensions: 60" x 60"
- » Height: 24"
- » Burning Area: 48" x 48" x 2"
- » Weight: 215 lbs.
- » BTU: 65K
- » Sugg. Fire Glass: 239 lbs.

Optional Accessories

Unit	Canvas Cover	Stainless Lid	Glass Wind Guard
30" Forma	OPT-CVR-3030	OPT-20SC	OPT-WG-2222
42" Forma	OPT-CVR-4242	OPT-26SC	OPT-WG-2828
48" Forma	OPT-CVR-4848	OPT-32SC	OPT-WG-3434
60" Forma	OPT-CVR-6060	OPT-38SC	OPT-WG-4040
72" Forma	OPT-CVR-7272	OPT-50SC	OPT-WG-5252



POWDER COAT COLOR OPTIONS

When ordering, specify the powder coat color by adding the color code to the end of the Part #. **Example:** White Coronado Fire Pit = OPT-CORPC48-WHT

White -WHT	Gray -GRY	Pewter -PEW	Black -BLK
Silver Vein -SLV	Copper Vein -CPV	Java -JAV	

FIRE PITS & FIRE TABLES

All fire pits include: Fire Pan, Burner, Key Valve, Key, Gas Hoses, Lava Rock.
For Match Lit w/ Flame Sense add "-FSML" to part #. For 110V Ignition, add "-EKIT"



36" CABO IN HAMMERED COPPER (LEFT)
48" CABO IN CORTEN STEEL (MIDDLE)
60" CABO IN STAINLESS STEEL (RIGHT)

Square Cabo Collection

Eaves Fire Pits cannot store propane tank.

36" Cabo Square Fire Pit

OPT-CBSQ36CPR Hammered Copper
OPT-CBSQ36CS Corten Steel
OPT-CBSQ36SS Stainless Steel
OPT-CBSQ36PC Powder Coat

- » Dimensions: 36" x 36"
- » Height: 16"
- » Base: 24" x 24"
- » Burn Area: 20" x 20"
- » Weight: 90 lbs.
- » BTU: 65K
- » Sugg. Fire Glass: 50 lbs.

48" Cabo Square Fire Pit

OPT-CBSQ48CPR Hammered Copper
OPT-CBSQ48CS Corten Steel
OPT-CBSQ48SS Stainless Steel
OPT-CBSQ48PC Powder Coat

- » Dimensions: 48" x 48"
- » Height: 16"
- » Base: 36" x 36"
- » Burn Area: 28" x 28"
- » Weight: 125 lbs.
- » BTU: 65K
- » Sugg. Fire Glass: 75 lbs.

60" Cabo Square Fire Pit

OPT-CBSQ60CPR Hammered Copper
OPT-CBSQ60CS Corten Steel
OPT-CBSQ60SS Stainless Steel
OPT-CBSQ60PC Powder Coat

- » Dimensions: 60" x 60"
- » Height: 16"
- » Base: 48" x 48"
- » Burn Area: 40" x 40"
- » Weight: 180 lbs.
- » BTU: 65K
- » Sugg. Fire Glass: 75 lbs.

Optional Accessories

Unit	Canvas Cover	Stainless Lid	Glass Wind Guard
36" Square Cabo	OPT-CVR-3636	OPT-22SC	OPT-WG-2424
48" Square Cabo	OPT-CVR-4848	OPT-30SC	OPT-WG-3232
60" Square Cabo	OPT-CVR-6060	OPT-42SC	OPT-WG-4444



POWDER COAT COLOR OPTIONS

When ordering, specify the powder coat color by adding the color code to the end of the Part #. **Example:** White Coronado Fire Pit = OPT-CORPC48-WHT

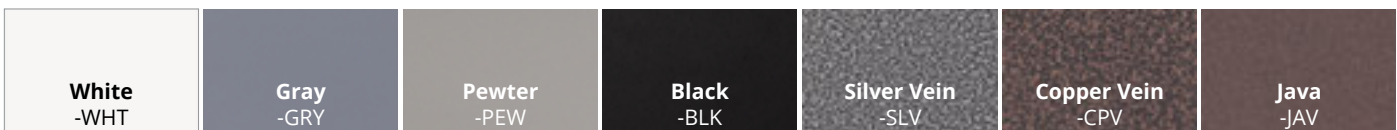

FIRE PITS & FIRE TABLES

All fire pits include: Fire Pan, Burner, Key Valve, Key, Gas Hoses, Lava Rock.
For Match Lit w/ Flame Sense add "-FSML" to part #. For 110V Ignition, add "-EKIT"

56" X 38" CABO IN CORTEN STEEL (LEFT)
66" X 38" CABO IN CORTEN STEEL (MIDDLE)
90" X 38" CABO IN BLACK POWDER COAT (RIGHT)



Linear Cabo Collection

Eaves Fire Pits cannot store propane tank.

56" X 38" Cabo Fire Pit

OPT-CBLN56CPR Hammered Copper
OPT-CBLN56CS Corten Steel
OPT-CBLN56SS Stainless Steel
OPT-CBLN56PC Powder Coat

- » Dimensions: 56" x 38"
- » Height: 16"
- » Base: 44" x 26"
- » Burn Area: 36" x 16"
- » Weight: 245 lbs.
- » BTU: 65K
- » Sugg. Fire Glass: 75 lbs.

66" X 38" Cabo Fire Pit

OPT-CBLN66CPR Hammered Copper
OPT-CBLN66CS Corten Steel
OPT-CBLN66SS Stainless Steel
OPT-CBLN66PC Powder Coat

- » Dimensions: 66" x 38"
- » Height: 16"
- » Base: 54" x 26"
- » Burn Area: 36" x 16"
- » Weight: 330 lbs.
- » BTU: 65K
- » Sugg. Fire Glass: 75 lbs.

90" X 38" Cabo Fire Pit

OPT-CBLN90CPR Hammered Copper
OPT-CBLN90CS Corten Steel
OPT-CBLN90SS Stainless Steel
OPT-CBLN90PC Powder Coat

- » Dimensions: 90" x 38"
- » Height: 16"
- » Base: 78" x 26"
- » Burn Area: 66" x 16"
- » Weight: 435 lbs.
- » BTU: 65K
- » Sugg. Fire Glass: 125 lbs.

Optional Accessories

Unit	Canvas Cover	Stainless Lid	Glass Wind Guard
56" Linear Cabo	OPT-CVR-5638	OPT-RC1838	OPT-WG-2040
66" Linear Cabo	OPT-CVR-6638	OPT-RC1844	OPT-WG-2046
90" Linear Cabo	OPT-CVR-9038	OPT-RC1868	OPT-WG-2070



FIRE PITS & FIRE TABLES

All fire pits include: Fire Pan, Burner, Key Valve, Key, Gas Hoses, Lava Rock.
For Match Lit w/ Flame Sense add "-FSML" to part #. For 110V Ignition, add "-EKIT"



48" X 24" STAINLESS STEEL



48" X 24" CORTEN STEEL



72" X 24" HAMMERED COPPER

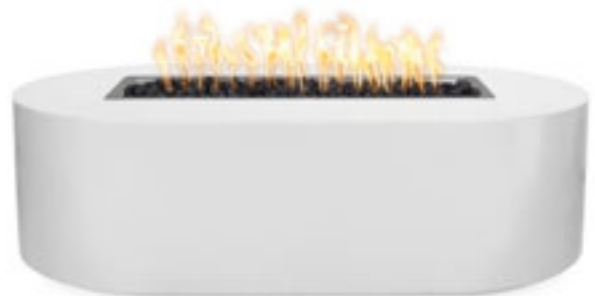

48" X 24" WHITE POWDER COAT

Bispo Collection

48" x 24" Bispo Fire Pit

OPT-BSPCPR48 Hammered Copper
OPT-BSPCS48 Corten Steel
OPT-BSPSS48 Stainless Steel
OPT-BSPPC48 Powder Coat

- » Dimensions: 48" x 24"
- » Height: 15"
- » Burning Area: 30" x 10"
- » Weight: 120 lbs.
- » BTU: 65K
- » Sugg. Fire Glass: 50 lbs.

60" x 24" Bispo Fire Pit

OPT-BSPCPR60 Hammered Copper
OPT-BSPCS60 Corten Steel
OPT-BSPSS60 Stainless Steel
OPT-BSPPC60 Powder Coat

- » Dimensions: 60" x 24"
- » Height: 15"
- » Burning Area: 42" x 10"
- » Weight: 180 lbs.
- » BTU: 65K
- » Sugg. Fire Glass: 75 lbs.

72" x 24" Bispo Fire Pit

OPT-BSPCPR72 Hammered Copper
OPT-BSPCS72 Corten Steel
OPT-BSPSS72 Stainless Steel
OPT-BSPPC72 Powder Coat

- » Dimensions: 72" x 24"
- » Height: 15"
- » Burning Area: 54" x 10"
- » Weight: 240 lbs.
- » BTU: 65K
- » Sugg. Fire Glass: 75 lbs.

84" x 24" Bispo Fire Pit

OPT-BSPCPR84 Hammered Copper
OPT-BSPCS84 Corten Steel
OPT-BSPSS84 Stainless Steel
OPT-BSPPC84 Powder Coat

- » Dimensions: 84" x 24"
- » Height: 15"
- » Burning Area: 66" x 10"
- » Weight: 315 lbs.
- » BTU: 65K
- » Sugg. Fire Glass: 50 lbs.

Optional Accessories

Unit	Canvas Cover	Stainless Lid	Glass Wind Guard
48" Bispo	OPT-CVR-4824	OPT-RC1232	OPT-WG-3414
60" Bispo	OPT-CVR-6024	OPT-RC1244	OPT-WG-4614
72" Bispo	OPT-CVR-7224	OPT-RC1256	OPT-WG-5814
84" Bispo	OPT-CVR-8424	OPT-RC1268	OPT-WG-7014

POWDER COAT COLOR OPTIONS

When ordering, specify the powder coat color by adding the color code to the end of the Part #. **Example:** White Coronado Fire Pit = OPT-CORPC48-WHT

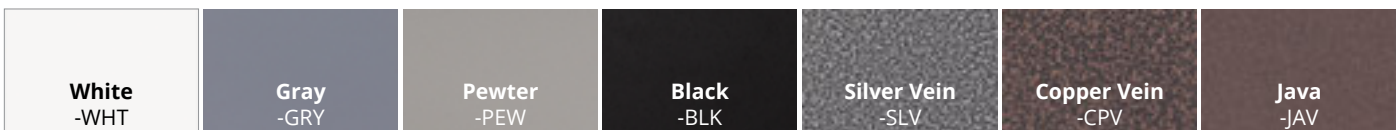

FIRE PITS & FIRE TABLES

All fire pits include: Fire Pan, Burner, Key Valve, Key, Gas Hoses, Lava Rock.
For Match Lit w/ Flame Sense add "-FSML" to part #. For 110V Ignition, add "-EKIT"



48" X 28" CORTEN STEEL



48" X 28" SILVER VEIN POWDER COAT

La Jolla Collection

Cannot store propane tank.

All units except corten steel include a visible stainless steel lip as shown in the photos above & below.

48" x 28" La Jolla Fire Pit

OPT-LAJCPR48	Hammered Copper
OPT-LAJCS48	Corten Steel
OPT-LAJSS48	Stainless Steel
OPT-LAJPC48	Powder Coat

- » Dimensions: 48" x 28"
- » Height: 15"
- » Burning Area: 30" x 10" x 2"
- » Weight: 175 lbs.
- » BTU: 45K
- » Sugg. Fire Glass: 50 lbs.

60" x 28" La Jolla Fire Pit

OPT-LAJCPR60	Hammered Copper
OPT-LAJCS60	Corten Steel
OPT-LAJSS60	Stainless Steel
OPT-LAJPC60	Powder Coat

- » Dimensions: 60" x 28"
- » Height: 15"
- » Burning Area: 42" x 10" x 2"
- » Weight: 195 lbs.
- » BTU: 65K
- » Sugg. Fire Glass: 50 lbs.

72" x 28" La Jolla Fire Pit

OPT-LAJCPR72	Hammered Copper
OPT-LAJCS72	Corten Steel
OPT-LAJSS72	Stainless Steel
OPT-LAJPC72	Powder Coat

- » Dimensions: 72" x 28"
- » Height: 15"
- » Burning Area: 54" x 10" x 2"
- » Weight: 220 lbs.
- » BTU: 80K
- » Sugg. Fire Glass: 75 lbs.

84" x 28" La Jolla Fire Pit

OPT-LAJCPR84	Hammered Copper
OPT-LAJCS84	Corten Steel
OPT-LAJSS84	Stainless Steel
OPT-LAJPC84	Powder Coat

- » Dimensions: 84" x 28"
- » Height: 15"
- » Burning Area: 66" x 10" x 2"
- » Weight: 245 lbs.
- » BTU: 110K
- » Sugg. Fire Glass: 75 lbs.

96" x 28" La Jolla Fire Pit

OPT-LAJCPR96	Hammered Copper
OPT-LAJCS96	Corten Steel
OPT-LAJSS96	Stainless Steel
OPT-LAJPC96	Powder Coat

- » Dimensions: 96" x 28"
- » Height: 15"
- » Burning Area: 78" x 10" x 2"
- » Weight: 270 lbs.
- » BTU: 135K
- » Sugg. Fire Glass: 100 lbs.

Optional Accessories

Unit	Canvas Cover	Stainless Lid	Glass Wind Guard
48" La Jolla	OPT-CVR-4828	OPT-RC1232	OPT-WG-3414
60" La Jolla	OPT-CVR-6028	OPT-RC1244	OPT-WG-4614
72" La Jolla	OPT-CVR-7228	OPT-RC1256	OPT-WG-5814
84" La Jolla	OPT-CVR-8428	OPT-RC1268	OPT-WG-7014
96" La Jolla	OPT-CVR-9628	OPT-RC1280	OPT-WG-8214

La Jolla - Stainless Steel

48" x 28" La Jolla (left)
96" x 28" La Jolla (middle)
60" x 28" La Jolla (right)

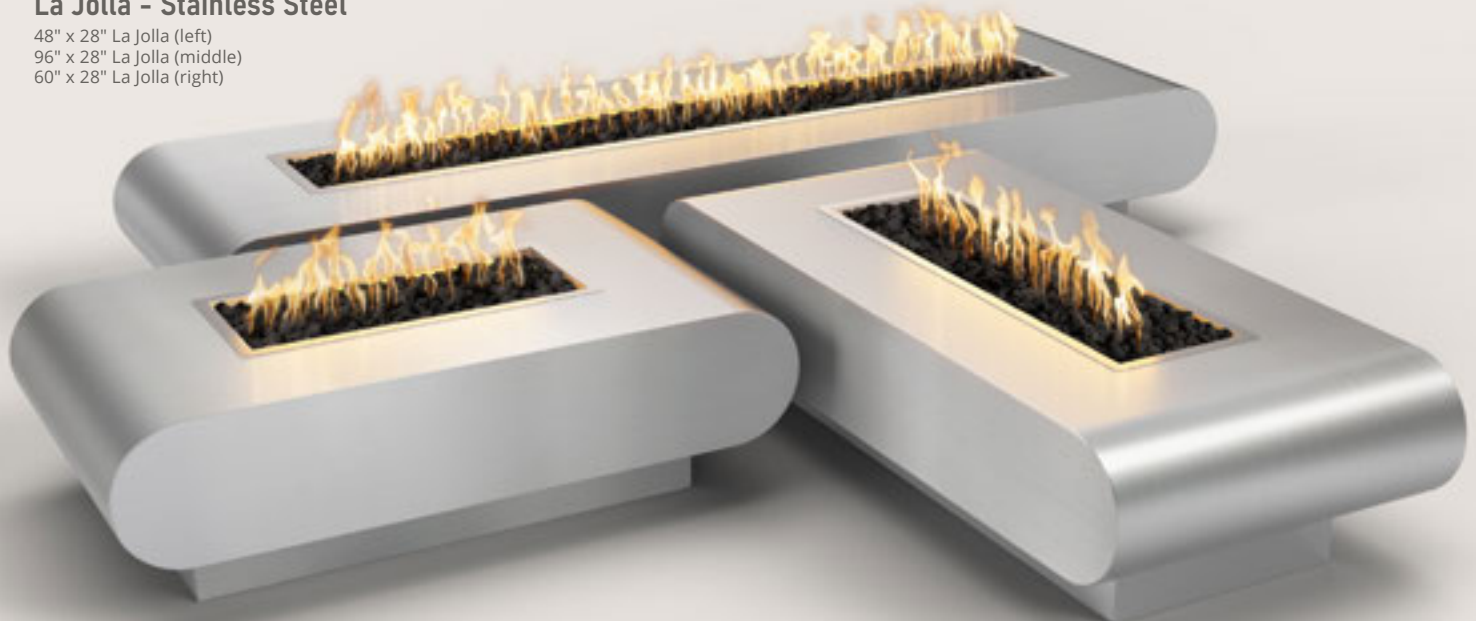



30" CORTEN STEEL



42" WHITE POWDER COAT



30" STAINLESS STEEL

Beverly Collection

Includes access door for 20 lbs propane tank storage

30" Beverly Fire Pit

- OPT-30RRCPR Hammered Copper
- OPT-30RRCS Corten Steel
- OPT-30RRSS Stainless Steel
- OPT-30PCB Powder Coat

- » Diameter: 30"
- » Height: 24"
- » Burning Area: 19"
- » Weight: 105 lbs.
- » BTU: 50K
- » Sugg. Fire Glass: 50 lbs.

36" Beverly Fire Pit

- OPT-36RRCPR Hammered Copper
- OPT-36RRCS Corten Steel
- OPT-36RRSS Stainless Steel
- OPT-36PCB Powder Coat

- » Diameter: 36"
- » Height: 24"
- » Burning Area: 25"
- » Weight: 150 lbs.
- » BTU: 75K
- » Sugg. Fire Glass: 50 lbs.

42" Beverly Fire Pit

- OPT-42RRCPR Hammered Copper
- OPT-42RRCS Corten Steel
- OPT-42RRSS Stainless Steel
- OPT-42PCB Powder Coat

- » Diameter: 42"
- » Height: 24"
- » Burning Area: 31"
- » Weight: 185 lbs.
- » BTU: 90K
- » Sugg. Fire Glass: 75 lbs.



Optional Accessories

Unit	Canvas Cover	Stainless Lid
30" Beverly	OPT-CVR-30R	OPT-23RC
36" Beverly	OPT-CVR-36R	OPT-29RC
42" Beverly	OPT-CVR-42R	OPT-35RC

Billow Collection

Includes access door for 20 lbs propane tank storage

60" Billow

- OPT-BLWSS60 Stainless Steel
- OPT-BLWCS60 Corten Steel
- OPT-BLWPC60 Powder Coat

- » Dimensions: 60" x 24"
- » Height: 24"
- » Burning Area: 48" x 12" x 2"
- » Weight: 195 lbs.
- » BTU: 75K
- » Sugg. Fire Glass: 50 lbs.



72" CORTEN STEEL

72" Billow

- OPT-BLWSS72 Stainless Steel
- OPT-BLWCS72 Corten Steel
- OPT-BLWPC72 Powder Coat

- » Dimensions: 72" x 24"
- » Height: 24"
- » Burning Area: 60" x 12" x 2"
- » Weight: 230 lbs.
- » BTU: 90K
- » Sugg. Fire Glass: 75 lbs.



60" STAINLESS STEEL



60" COPPER VEIN POWDER COAT

Optional Accessories

Unit	Canvas Cover
60" Billow	OPT-CVR-6024
72" Billow	OPT-CVR-6024

FIRE PITS & FIRE TABLES

All fire pits include: Fire Pan, Burner, Key Valve, Key, Gas Hoses, Lava Rock.
For Match Lit w/ Flame Sense add "-FSML" to part #. For 110V Ignition, add "-EKIT"



60" STAINLESS STEEL



60" HAMMERED COPPER

Unity Collection - 18" Tall

18" Tall Units: Do not include door for propane tank storage.

48" Unity Fire Pit

OPT-UNYCP4818 Hammered Copper
OPT-RCRTN4818 Corten Steel
OPT-UNYSS4818 Stainless Steel
OPT-UNYPC4818 Powder Coat

60" Unity Fire Pit

OPT-UNYCP6018 Hammered Copper
OPT-RCRTN6018 Corten Steel
OPT-UNYSS6018 Stainless Steel
OPT-UNYPC6018 Powder Coat

72" Unity Fire Pit

OPT-UNYCP7218 Hammered Copper
OPT-RCRTN7218 Corten Steel
OPT-UNYSS7218 Stainless Steel
OPT-UNYPC7218 Powder Coat

Unity Collection - 24" Tall

24" Tall Units: Includes access door for 20 lbs propane tank storage

48" Unity Fire Pit

OPT-UNYCP48 Hammered Copper
OPT-RCRTN48 Corten Steel
OPT-UNYSS48 Stainless Steel
OPT-UNYPC48 Powder Coat

60" Unity Fire Pit

OPT-UNYCP60 Hammered Copper
OPT-RCRTN60 Corten Steel
OPT-UNYSS60 Stainless Steel
OPT-UNYPC60 Powder Coat

72" Unity Fire Pit

OPT-UNYCP72 Hammered Copper
OPT-RCRTN72 Corten Steel
OPT-UNYSS72 Stainless Steel
OPT-UNTPC72 Powder Coat



- » Diameter: 48"
- » Height: 18" / 24"
- » Burning Area: 24"
- » Weight: 155 lbs / 185 lbs
- » BTU: 65K
- » Sugg. Fire Glass: 50 lbs.

- » Diameter: 60"
- » Height: 18" / 24"
- » Burning Area: 36"
- » Weight: 210 lbs / 250 lbs
- » BTU: 160K
- » Sugg. Fire Glass: 100 lbs.

- » Diameter: 72"
- » Height: 18" / 24"
- » Burning Area: 48"
- » Weight: 270 lbs / 320 lbs
- » BTU: 190K
- » Sugg. Fire Glass: 200 lbs.

Optional Accessories

Unit	Canvas Cover	Stainless Lid
48" Unity	OPT-CVR-48R	OPT-26RC
60" Unity	OPT-CVR-60R	OPT-38RC
72" Unity	OPT-CVR-72R	OPT-50RC



72" WHITE POWDER COAT



60" CORTEN STEEL

72" Unity Shown - 18" Height
OPT-UNYCP7218

Merona Fire Table

Includes access door for 20 lbs propane tank storage

TOP-MC4622	Match Lit
TOP-MC4622FSML	Flame Sense
TOP-MC4622EKIT	110V Plug & Play

- » Dimensions: 46" x 22"
- » Height: 24"
- » Burning Area: 30" x 8"
- » Weight: 195 Lbs.
- » BTU: 65K
- » Sugg. Fire Glass: 25 lbs.
- » Material: Steel Body / Stainless Steel Top
- » Finish: Powder Coat / Brushed Stainless Steel



Optional Accessories

Canvas Cover	OPT-CVR-4622
Stainless Steel Lid	OPT-RC1032
Glass Wind Guard	OPT-WG-3412

Quad Collection

Cannot store propane tank.

36" Quad Fire Pit

OPT-QDCPR36	Hammered Copper
OPT-QDCS36	Corten Steel
OPT-QDSS36	Stainless Steel
OPT-QDPC36	Powder Coat

- » Dimensions: 36" x 36"
- » Height: 15"
- » Burning Area: 18" x 18" x 2"
- » Weight: 90 lbs.
- » BTU: 65K
- » Sugg. Fire Glass: 50 lbs.

42" Quad Fire Pit

OPT-QDCPR42	Hammered Copper
OPT-QDCS42	Corten Steel
OPT-QDSS42	Stainless Steel
OPT-QDPC42	Powder Coat

- » Dimensions: 42" x 42"
- » Height: 15"
- » Burning Area: 24" x 24" x 2"
- » Weight: 105 lbs.
- » BTU: 65K
- » Sugg. Fire Glass: 75 lbs.



Optional Accessories

Unit	Canvas Cover	Stainless Lid	Glass Wind Guard
36" Quad	OPT-CVR-3636	OPT-20SC	OPT-WG-2222
42" Quad	OPT-CVR-4242	OPT-26SC	OPT-WG-2828

Bella Collection

Includes door for propane tank storage

36" Bella Fire Table

OPT-BELSS36	Stainless Steel
OPT-BELPC36	Powder Coat Steel

- » Dimensions: 36" x 36"
- » Base Dimensions: 18" x 18"
- » Height: 24"
- » Burning Area: 16"
- » Weight: 90 lbs.
- » BTU: 65K
- » Sugg. Fire Glass: 30 lbs.

60" Bella Fire Table

OPT-BELSS60	Stainless Steel
OPT-BELPC60	Powder Coat Steel

- » Dimensions: 60" x 60"
- » Base Dimensions: 30" x 30"
- » Height: 24"
- » Burning Area: 30"
- » Weight: 210 lbs.
- » BTU: 65K
- » Sugg. Fire Glass: 30 lbs.



Optional Accessories

Unit	Canvas Cover	Stainless Lid	Glass Wind Guard
36" Bella	OPT-CVR-3636	OPT-18SC	OPT-WG-2020
60" Bella	OPT-CVR-6060	OPT-26SC	OPT-WG-2828

POWDER COAT COLOR OPTIONS

When ordering, specify the powder coat color by adding the color code to the end of the Part #. **Example:** White Coronado Fire Pit = OPT-CORPC48-WHT

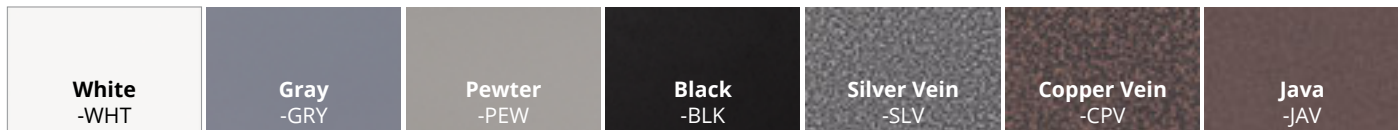

Linear Bella Collection

Includes door for propane tank storage

48 x 30" Bella Fire Table

OPT-BELLSS4830 Stainless Steel
OPT-BELLPC4830 Powder Coat Steel

- » Dimensions: 48" x 30"
- » Base Dimensions: 30" x 18"
- » Height: 24"
- » Burning Area: 18" x 8"
- » Weight: 110 lbs.
- » BTU: 65K
- » Sugg. Fire Glass: 30 lbs.

60 x 36" Bella Fire Table

OPT-BELLSS6036 Stainless Steel
OPT-BELLPC6036 Powder Coat Steel

- » Dimensions: 60" x 36"
- » Base Dimensions: 42" x 18"
- » Height: 24"
- » Burning Area: 30" x 8"
- » Weight: 190 lbs.
- » BTU: 65K
- » Sugg. Fire Glass: 30 lbs.

72 x 36" Bella Fire Table

OPT-BELLSS7236 Stainless Steel
OPT-BELLPC7236 Powder Coat Steel

- » Dimensions: 72" x 36"
- » Base Dimensions: 54" x 18"
- » Height: 30"
- » Burning Area: 42" x 8"
- » Weight: 250lbs.
- » BTU: 65K
- » Sugg. Fire Glass: 30 lbs.

Optional Accessories

Unit	Canvas Cover	Stainless Lid	Glass Wind Guard
48" x 30" Bella	OPT-CVR4830	OPT-RC1020	OPT-WG-2212
60" x 36" Bella	OPT-CVR6036	OPT-RC1032	OPT-WG-3412
72" x 36" Bella	OPT-CVR7236	OPT-RC1044	OPT-WG-4612



Alameda Collection

Includes 2 access doors for LP tank storage.

60" x 28" Alameda Fire Table

OPT-ALMPC60 Match Lit
OPT-ALMPC60FSML Flame Sense
OPT-ALMPC60EKIT 110V Plug & Play

- » Dimensions: 60" x 28"
- » Base Dimensions: 52" x 20"
- » Height: 30"
- » Burning Area: 30" x 10"
- » Weight: 150 lbs.
- » BTU: 65K
- » Sugg. Fire Glass: 30 lbs.

78" x 36" Alameda Fire Table

OPT-ALMPC78 Match Lit
OPT-ALMPC78FSML Flame Sense
OPT-ALMPC78EKIT 110V Plug & Play

- » Dimensions: 78" x 36"
- » Base Dimensions: 70" x 24"
- » Height: 30"
- » Burning Area: 48" x 10"
- » Weight: 200 lbs.
- » BTU: 65K
- » Sugg. Fire Glass: 50 lbs.



60" X 28" MODEL SHOWN IN JAVA FINISH
GLASS WIND GUARD NOT INCLUDED.

Optional Accessories

Unit	Canvas Cover	Stainless Lid	Glass Wind Guard
60" x 28" Alameda	OPT-CVR-6028	OPT-RC1232	OPT-WG-3614
78" x 28" Alameda	OPT-CVR-7836	OPT-RC1250	OPT-WG-5214



MATERIAL OPTIONS

- » Concrete top options found on page 63
- » Corten steel option found on page 90



Mabel Collection

Includes door for propane tank storage

36" Mabel Fire Table

OPT-MABCS36	Corten Steel
OPT-MABSS36	Stainless Steel
OPT-MABPC36	Powder Coat
OPT-MABCPR36	Hammered Copper

- » Diameter: 36"
- » Base Diameter: 24"
- » Height: 20"
- » Burning Area: 19"
- » Weight: 90 lbs.
- » BTU: 65K
- » Sugg. Fire Glass: 30 lbs.

48" Mabel Fire Table

OPT-MABCS48	Corten Steel
OPT-MABSS48	Stainless Steel
OPT-MABPC48	Powder Coat
OPT-MABCPR48	Hammered Copper

- » Diameter: 48"
- » Base Diameter: 30"
- » Height: 20"
- » Burning Area: 19"
- » Weight: 120 lbs.
- » BTU: 65K
- » Sugg. Fire Glass: 30 lbs.

60" Mabel Fire Table

OPT-MABCS60	Corten Steel
OPT-MABSS60	Stainless Steel
OPT-MABPC60	Powder Coat
OPT-MABCPR60	Hammered Copper

- » Diameter: 60"
- » Base Diameter: 42"
- » Height: 20"
- » Burning Area: 25"
- » Weight: 175 lbs.
- » BTU: 65K
- » Sugg. Fire Glass: 55 lbs.



Optional Accessories

Unit	Canvas Cover	Stainless Lid	Glass Wind Guard
36" Mabel	OPT-CVR4830	OPT-RC1020	OPT-WG-2212
48" Mabel	OPT-CVR6036	OPT-RC1032	OPT-WG-3412
60" Mabel	OPT-CVR7236	OPT-RC1044	OPT-WG-4612

42" Florence Fire Pit

Cannot store propane tank.

OPT-FLCPR42	Hammered Copper
OPT-FLCS42	Corten Steel
OPT-FLSS42	Stainless Steel
OPT-FLPC42	Powder Coat

- » Diameter: 42"
- » Height: 12"
- » Burn Area: 25"
- » BTU: 65K
- » Weight: 315 lbs.
- » Sugg. Fire Glass: 50 lbs.

Optional Accessories

Canvas Cover	OPT-CVR-42R
Stainless Steel Lid	OPT-28RC
Glass Wind Guard	OPT-WG-30



POWDER COAT COLOR OPTIONS

When ordering, specify the powder coat color by adding the color code to the end of the Part #. **Example:** White Coronado Fire Pit = OPT-CORPC48-WHT

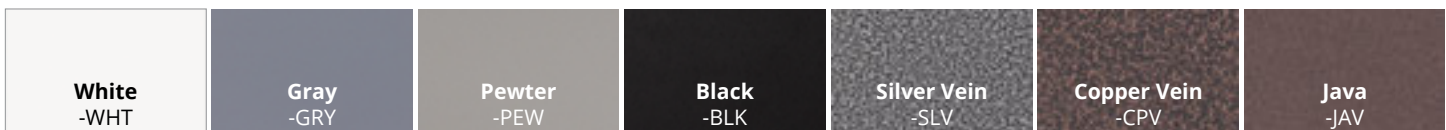

48" Cazo SS Fire Pit - Narrow Ledge

Cannot store propane tank.

OPT-SS48FP Match Lit Ignition
OPT-SS48FPFSML Flame Sense
OPT-SS48FPEKIT 110V Ignition

- » Diameter: 48"
- » Height: 15"
- » Burning Area: 42"
- » Base Diameter: 24"
- » Weight: 155 Lbs.
- » BTU: 65K
- » Sugg. Fire Glass: 100 lbs.

Optional Accessories

Canvas Cover	OPT-CVR-48R
Stainless Steel Lid	OPT-44RC



Tidal Fire Pit

Includes access door for 20 lbs propane tank storage

OPT-TIDCPR48 Hammered Copper
OPT-TIDCS48 Corten Steel
OPT-TIDSS48 Stainless Steel
OPT-TIDPC48 Powder Coat

- » Dimensions: 48" x 24"
- » Height: 24"
- » Burning Area: 30" x 8"
- » Weight: 100 lbs.
- » BTU: 65K
- » Sugg. Fire Glass: 75 lbs.



Optional Accessories

Canvas Cover	OPT-CVR-4242
Stainless Steel Lid	OPT-26SC
Glass Wind Guard	OPT-WG-2828



Vernon Fire Pit

Cannot store propane tank.

OPT-VRNSS

- » Dimensions: 86" x 24"
- » Height: 27"
- » Burning Area: 30" x 8" x 2"
- » Weight: 185 lbs.
- » BTU: 65K
- » Sugg. Fire Glass: 25 lbs.
- » Material: Stainless Steel
- » Finish: Brushed



Optional Accessories

Stainless Steel Lid	OPT-RC1022
Glass Wind Guard	OPT-WG-2412



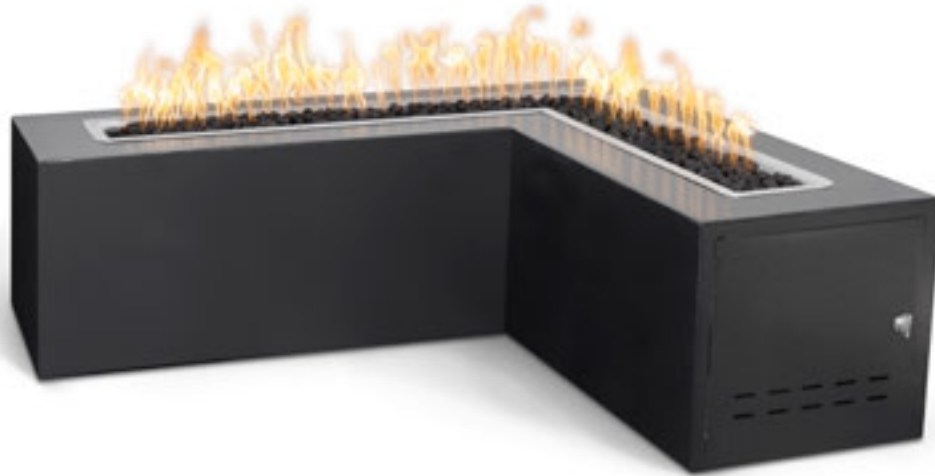

Whitney Collection

Includes access door for 20 lbs propane tank storage

48" Whitney Fire Pit

OPT-WHTPC48 Match Lit
OPT-WHTPC48FSML Flame Sense
OPT-WHTPC48EKIT 110V Plug & Play

- » Outer Dimensions: 48" x 48"
- » Inner Dimensions: 24" x 24"
- » Width: 24"
- » Height: 24"
- » Burning Area: 36" x 36" x 10"
- » BTUs: 65K
- » Sugg. Fire Glass: 100 lbs.

60" Whitney Fire Pit

OPT-WHTPC60 Match Lit
OPT-WHTPC60FSML Flame Sense
OPT-WHTPC60EKIT 110V Plug & Play

- » Outer Dimensions: 60" x 60"
- » Inner Dimensions: 36" x 36"
- » Width: 24"
- » Height: 24"
- » Burning Area: 48" x 48" x 10"
- » BTUs: 65K
- » Sugg. Fire Glass: 100 lbs.

72" Whitney Fire Pit

OPT-WHTPC72 Match Lit
OPT-WHTPC72FSML Flame Sense
OPT-WHTPC72EKIT 110V Plug & Play

- » Outer Dimensions: 72" x 72"
- » Inner Dimensions: 48" x 48"
- » Width: 24"
- » Height: 24"
- » Burning Area: 60" x 60" x 10"
- » BTUs: 65K
- » Sugg. Fire Glass: 125 lbs.



Dana Fire Pit

Includes access door for 20 lbs propane tank storage

OPT-DANPC60 Match Lit Ignition
OPT-DANPC60FSML Flame Sense
OPT-DANPC60EKIT 110V Ignition

- » Dimensions: 60" x 28"
- » Height: 24"
- » Burn Area: 12" x 12"
- » Ice Chest: 13"
- » Weight: 315 lbs.
- » BTU: 65K
- » Sugg. Fire Glass: 50 lbs.
- » Material: Steel
- » Finish: Powder Coat



Optional Accessories

Canvas Cover	OPT-CVR-6028
Stainless Steel Lid	OPT-14SC
Glass Wind Guard	OPT-WG-1616

POWDER COAT COLOR OPTIONS

When ordering, specify the powder coat color by adding the color code to the end of the Part #. **Example:** White Coronado Fire Pit = OPT-CORPC48-WHT

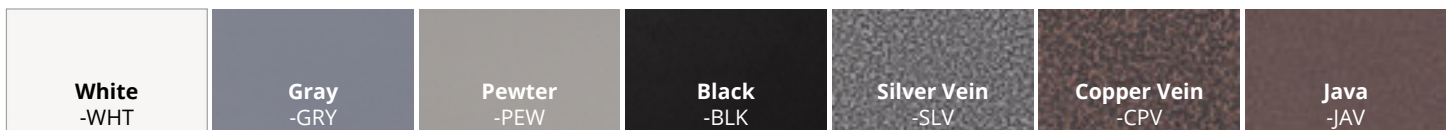

FIRE PITS & FIRE TABLES

All fire pits include: Fire Pan, Burner, Key Valve, Key, Gas Hoses, Lava Rock.
For Match Lit w/ Flame Sense add "-FSML" to part #. For 110V Ignition, add "-EKIT"



Linear Avalon Collection - 15" Tall

Does not include door for propane tank storage.

48" x 28" Avalon Fire Pit

OPT-AVLCPR4815 Hammered Copper
OPT-AVLCS4815 Corten Steel
OPT-AVLSS4815 Stainless Steel
OPT-AVLPC4815 Powder Coat

- » Dimensions: 48" x 28"
- » Height: 15"
- » Burning Area: 30" x 10"
- » Weight: 85 lbs.
- » BTU: 65K
- » Sugg. Fire Glass: 50 lbs.

60" x 28" Avalon Fire Pit

OPT-AVLCPR6015 Hammered Copper
OPT-AVLCS6015 Corten Steel
OPT-AVLSS6015 Stainless Steel
OPT-AVLPC6015 Powder Coat

- » Dimensions: 60" x 28"
- » Height: 15"
- » Burning Area: 42" x 10"
- » Weight: 105 lbs.
- » BTU: 65K
- » Sugg. Fire Glass: 50 lbs.

72" x 28" Avalon Fire Pit

OPT-AVLCPR7215 Hammered Copper
OPT-AVLCS7215 Corten Steel
OPT-AVLSS7215 Stainless Steel
OPT-AVLPC7215 Powder Coat

- » Dimensions: 72" x 28"
- » Height: 15"
- » Burning Area: 54" x 10"
- » Weight: 130 lbs.
- » BTU: 65K
- » Sugg. Fire Glass: 50 lbs.

84" x 28" Avalon Fire Pit

OPT-AVLCPR8415 Hammered Copper
OPT-AVLCS8415 Corten Steel
OPT-AVLSS8415 Stainless Steel
OPT-AVLPC8415 Powder Coat

- » Dimensions: 84" x 28"
- » Height: 15"
- » Burning Area: 66" x 10"
- » Weight: 155 lbs.
- » BTU: 65K
- » Sugg. Fire Glass: 75 lbs.

Linear Avalon Fire Pit - 24" Tall

Includes access door for 20 lbs propane tank storage

48" x 28" Avalon Fire Pit

OPT-AVLCPR4824 Hammered Copper
OPT-AVLCS4824 Corten Steel
OPT-AVLSS4824 Stainless Steel
OPT-AVLPC4824 Powder Coat

- » Dimensions: 48" x 28"
- » Height: 24"
- » Burning Area: 30" x 10"
- » Weight: 85 lbs.
- » BTU: 65K
- » Sugg. Fire Glass: 50 lbs.

60" x 28" Avalon Fire Pit

OPT-AVLCPR6024 Hammered Copper
OPT-AVLCS6024 Corten Steel
OPT-AVLSS6024 Stainless Steel
OPT-AVLPC6024 Powder Coat

- » Dimensions: 60" x 28"
- » Height: 24"
- » Burning Area: 42" x 10"
- » Weight: 105 lbs.
- » BTU: 65K
- » Sugg. Fire Glass: 50 lbs.

72" x 28" Avalon Fire Pit

OPT-AVLCPR7224 Hammered Copper
OPT-AVLCS7224 Corten Steel
OPT-AVLSS7224 Stainless Steel
OPT-AVLPC7224 Powder Coat

- » Dimensions: 72" x 28"
- » Height: 24"
- » Burning Area: 54" x 10"
- » Weight: 130 lbs.
- » BTU: 65K
- » Sugg. Fire Glass: 50 lbs.

84" x 28" Avalon Fire Pit

OPT-AVLCPR8424 Hammered Copper
OPT-AVLCS8424 Corten Steel
OPT-AVLSS8424 Stainless Steel
OPT-AVLPC8424 Powder Coat

- » Dimensions: 84" x 28"
- » Height: 24"
- » Burning Area: 66" x 10"
- » Weight: 155 lbs.
- » BTU: 65K
- » Sugg. Fire Glass: 75 lbs.

Optional Accessories

Unit	Canvas Cover	Stainless Lid	Glass Wind Guard
48" Linear Avalon	OPT-CVR-4828	OPT-RC1232	OPT-WG-3414
60" Linear Avalon	OPT-CVR-6028	OPT-RC1244	OPT-WG-4614
72" Linear Avalon	OPT-CVR-7228	OPT-RC1256	OPT-WG-5814
84" Linear Avalon	OPT-CVR-8428	OPT-RC1268	OPT-WG-7014

FIRE PITS & FIRE TABLES

All fire pits include: Fire Pan, Burner, Key Valve, Key, Gas Hoses, Lava Rock.
For Match Lit w/ Flame Sense add "-FSML" to part #. For 110V Ignition, add "-EKIT"



Fremont Collection - 15" Tall

Does not include door for propane tank storage.

48" x 32" Fremont Fire Pit

OPT-FRMCPR4815 Hammered Copper
OPT-FRMC4815 Corten Steel
OPT-FRMSS4815 Stainless Steel
OPT-FRMPC4815 Powder Coat

60" x 32" Fremont Fire Pit

OPT-FRMCPR6015 Hammered Copper
OPT-FRMC6015 Corten Steel
OPT-FRMSS6015 Stainless Steel
OPT-FRMPC6015 Powder Coat

72" x 32" Fremont Fire Pit

OPT-FRMCPR7215 Hammered Copper
OPT-FRMC7215 Corten Steel
OPT-FRMSS7215 Stainless Steel
OPT-FRMPC7215 Powder Coat

84" x 32" Fremont Fire Pit

OPT-FRMCPR8415 Hammered Copper
OPT-FRMC8415 Corten Steel
OPT-FRMSS8415 Stainless Steel
OPT-FRMPC8415 Powder Coat

Fremont Collection - 24" Tall

Includes access door for 20 lbs propane tank storage

48" x 32" Fremont Fire Pit

OPT-FRMCPR4824 Hammered Copper
OPT-FRMC4824 Corten Steel
OPT-FRMSS4824 Stainless Steel
OPT-FRMPC4824 Powder Coat

60" x 32" Fremont Fire Pit

OPT-FRMCPR6024 Hammered Copper
OPT-FRMC6024 Corten Steel
OPT-FRMSS6024 Stainless Steel
OPT-FRMPC6024 Powder Coat

72" x 32" Fremont Fire Pit

OPT-FRMCPR7224 Hammered Copper
OPT-FRMC7224 Corten Steel
OPT-FRMSS7224 Stainless Steel
OPT-FRMPC7224 Powder Coat

84" x 32" Fremont Fire Pit

OPT-FRMCPR8424 Hammered Copper
OPT-FRMC8424 Corten Steel
OPT-FRMSS8424 Stainless Steel
OPT-FRMPC8424 Powder Coat

- » Dimensions: 48" x 32"
- » Height: 15" / 24"
- » Base Dimensions: 36" x 20"
- » Burning Area: 30" x 10"
- » Weight: 85 lbs. / 105 lbs
- » BTU: 40K
- » Sugg. Fire Glass: 25 lbs.

- » Dimensions: 60" x 32"
- » Height: 15" / 24"
- » Base Dimensions: 48" x 20"
- » Burning Area: 42" x 10"
- » Weight: 100 lbs. / 120 lbs
- » BTU: 60K
- » Sugg. Fire Glass: lbs.

- » Dimensions: 72" x 32"
- » Height: 15" / 24"
- » Base Dimensions: 60" x 20"
- » Burning Area: 54" x 10"
- » Weight: 115 lbs. / 135 lbs
- » BTU: 80K
- » Sugg. Fire Glass: lbs.

- » Dimensions: 84" x 32"
- » Height: 15" / 24"
- » Base Dimensions: 72" x 20"
- » Burning Area: 66" x 10"
- » Weight: 130 lbs. / 155 lbs
- » BTU: 100K
- » Sugg. Fire Glass: lbs.

Optional Accessories

Unit	Canvas Cover	Stainless Lid	Glass Wind Guard
48" Fremont	OPT-CVR-4832	OPT-RC1232	OPT-WG-3414
60" Fremont	OPT-CVR-6032	OPT-RC1244	OPT-WG-4614
72" Fremont	OPT-CVR-7232	OPT-RC1256	OPT-WG-5814
84" Fremont	OPT-CVR-8432	OPT-RC1268	OPT-WG-7014

FIRE PITS & FIRE TABLES

All fire pits include: Fire Pan, Burner, Key Valve, Key, Gas Hoses, Lava Rock.
For Match Lit w/ Flame Sense add "-FSML" to part #. For 110V Ignition, add "-EKIT"



Imperial Collection - 15" Tall

Does not include door for propane tank storage.

60" x 30" Imperial Fire Pit

OPT-IMCPR6015	Hammered Copper
OPT-IMCS6015	Corten Steel
OPT-IMSS6015	Stainless Steel
OPT-IMPC6015	Powder Coat

72" x 30" Imperial Fire Pit

OPT-IMCPR7215	Hammered Copper
OPT-IMCS7215	Corten Steel
OPT-IMSS7215	Stainless Steel
OPT-IMPC7215	Powder Coat



Imperial Collection - 24" Tall

Includes access door for 20 lbs propane tank storage

60" x 28" Imperial Fire Pit

OPT-IMCPR6024	Hammered Copper
OPT-IMCS6024	Corten Steel
OPT-IMSS6024	Stainless Steel
OPT-IMPC6024	Powder Coat

72" x 28" Imperial Fire Pit

OPT-IMCPR7224	Hammered Copper
OPT-IMCS7224	Corten Steel
OPT-IMSS7224	Stainless Steel
OPT-IMPC7224	Powder Coat

- » Dimensions: 60" x 28"
- » Height: 15"/24"
- » Burning Area: 30" x 10"
- » Weight: 105/135 lbs.
- » BTU: 40K
- » Sugg. Fire Glass: 50 lbs.

- » Dimensions: 72" x 28"
- » Height: 15"/24"
- » Burning Area: 42" x 10"
- » Weight: 125/165 lbs.
- » BTU: 60K
- » Sugg. Fire Glass: 50 lbs.



Optional Accessories

Unit	Canvas Cover	Stainless Lid	Glass Wind Guard
66" Imperial	OPT-CVR-6028	OPT-RC1232	OPT-WG-3414
78" Imperial	OPT-CVR-7228	OPT-RC1244	OPT-WG-4614



Alto Collection

Includes access door for 20 lbs propane tank storage

66" x 28" Alto Fire Pit

OPT-ALTCPR66	Hammered Copper
OPT-ALTCS66	Corten Steel
OPT-ALTSS66	Stainless Steel
OPT-ALTPC66	Powder Coat

78" x 28" Alto Fire Pit

OPT-ALTCPR78	Hammered Copper
OPT-ALTCS78	Corten Steel
OPT-ALTSS78	Stainless Steel
OPT-ALTPC78	Powder Coat

- » Dimensions: 66" x 28"
- » Height: 24"
- » Burn Area Height: 8"
- » Burning Area: 24" x 10"
- » Weight: 160 lbs.
- » BTU: 65K
- » Sugg. Fire Glass: 25 lbs.

- » Dimensions: 78" x 28"
- » Height: 24"
- » Burn Area Height: 8"
- » Burning Area: 36" x 10"
- » Weight: 185 lbs.
- » BTU: 65K
- » Sugg. Fire Glass: 25 lbs.



Optional Accessories

Unit	Canvas Cover	Stainless Lid	Glass Wind Guard
66" Alto	OPT-CVR-6628	OPT-RC1226	OPT-WG-2814
78" Alto	OPT-CVR-7828	OPT-RC1238	OPT-WG-4014

POWDER COAT COLOR OPTIONS

When ordering, specify the powder coat color by adding the color code to the end of the Part #. **Example:** White Coronado Fire Pit = OPT-CORPC48-WHT

White -WHT	Gray -GRY	Pewter -PEW	Black -BLK	Silver Vein -SLV	Copper Vein -CPV	Java -JAV
---------------	--------------	----------------	---------------	---------------------	---------------------	--------------

Dixie Collection

Includes access door for 20 lbs propane tank storage

60" x 24" Fremont Fire Pit

OPT-DXCPR60	Hammered Copper
OPT-DXCS60	Corten Steel
OPT-DXSS60	Stainless Steel
OPT-DXPC60	Powder Coat

- » Dimensions: 60" x 24"
- » Height: 24"
- » Burning Area: 36" x 8"
- » Weight: 115 lbs.
- » BTU: 65K
- » Sugg. Fire Glass: 50 lbs.

72" x 24" Fremont Fire Pit

OPT-DXCPR72	Hammered Copper
OPT-DXCS72	Corten Steel
OPT-DXSS72	Stainless Steel
OPT-DXPC72	Powder Coat

- » Dimensions: 72" x 24"
- » Height: 24"
- » Burning Area: 48" x 8"
- » Weight: 180 lbs.
- » BTU: 65K
- » Sugg. Fire Glass: 50 lbs.



Optional Accessories

Unit	Canvas Cover	Stainless Lid
60" Dixie	OPT-CVR-7230	OPT-RC1244
72" Dixie	OPT-CVR-7230	OPT-RC1244



Vallejo Collection

Includes access door for 20 lbs propane tank storage

60" x 36" Vallejo Fire Table

OPT-VALCPR60	Hammered Copper
OPT-VALCS60	Corten Steel
OPT-VALSS60	Stainless Steel
OPT-VALPC60	Powder Coat

- » Dimensions: 60" x 36"
- » Base Dimensions: 48" x 24"
- » Overhang: 6"
- » Height: 24"
- » Burning Area: 30" x 10"
- » Weight: 115 lbs.
- » BTU: 40K
- » Sugg. Fire Glass: 50 lbs.

72" x 36" Vallejo Fire Table

OPT-VALCPR72	Hammered Copper
OPT-VALCS72	Corten Steel
OPT-VALSS72	Stainless Steel
OPT-VALPC72	Powder Coat

- » Dimensions: 72" x 36"
- » Base Dimensions: 60" x 24"
- » Overhang: 6"
- » Height: 24"
- » Burning Area: 42" x 10"
- » Weight: 165 lbs.
- » BTU: 65K
- » Sugg. Fire Glass: 50 lbs.



Optional Accessories

Unit	Canvas Cover	Stainless Lid	Glass Wind Guard
60" Vallejo	OPT-CVR-6030	OPT-RC1232	OPT-WG-3414
72" Vallejo	OPT-CVR-7230	OPT-RC1244	OPT-WG-4614



Frisco Collection

Does not include access door.

68" Frisco Fire Table

OPT-FRSCPR68	Hammered Copper
OPT-FRSCS68	Corten Steel
OPT-FRSSS68	Stainless Steel
OPT-FRSPC68	Powder Coat

- » Table Top Diameter: 48"
- » Overall Diameter: 68"
- » Burning Area: 19"
- » Height: 24"
- » Lower Clearance: 20"
- » Weight: 240 lbs.
- » BTU: 50K
- » Sugg. Fire Glass: 30 lbs.

80" Frisco Fire Table

OPT-FRSCPR80	Hammered Copper
OPT-FRSCS80	Corten Steel
OPT-FRSSS80	Stainless Steel
OPT-FRSPC80	Powder Coat

- » Table Top Diameter: 60"
- » Overall Diameter: 80"
- » Burning Area: 25"
- » Height: 24"
- » Lower Clearance: 20"
- » Weight: 285 lbs.
- » BTU: 65K
- » Sugg. Fire Glass: 50 lbs.



Optional Accessories

Unit	Canvas Cover	Stainless Lid
68" Frisco	OPT-CVR-68R	OPT-23RC
80" Frisco	OPT-CVR-80R	OPT-29RC

FIRE PITS & FIRE TABLES

All fire pits include: Fire Pan, Burner, Key Valve, Key, Gas Hoses, Lava Rock.
For Match Lit w/ Flame Sense add "-FSML" to part #. For 110V Ignition, add "-EKIT"



Calabasas Collection

Does not include access door.

60" x 28" Calabasas Fire Table

OPT-CLBCPR60	Hammered Copper
OPT-CLBCS60	Corten Steel
OPT-CLBSS60	Stainless Steel
OPT-CLBPC60	Powder Coat

- » Dimensions: 60" x 28"
- » Height: 24"
- » Burning Area: 30" x 10"
- » Weight: 135 lbs.
- » BTU: 40K
- » Sugg. Fire Glass: 25 lbs.

72" x 28" Calabasas Fire Table

OPT-CLBCPR72	Hammered Copper
OPT-CLBCS72	Corten Steel
OPT-CLBSS72	Stainless Steel
OPT-CLBPC72	Powder Coat

- » Dimensions: 72" x 28"
- » Height: 24"
- » Burning Area: 42" x 10"
- » Weight: 165 lbs.
- » BTU: 60K
- » Sugg. Fire Glass: 25 lbs.

84" x 36" Calabasas Fire Table

OPT-CLBCPR84	Hammered Copper
OPT-CLBCS84	Corten Steel
OPT-CLBSS84	Stainless Steel
OPT-CLBPC84	Powder Coat

- » Dimensions: 84" x 36"
- » Height: 24"
- » Burning Area: 54" x 10"
- » Weight: 200 lbs.
- » BTU: 65K
- » Sugg. Fire Glass: 25 lbs.

96" x 36" Calabasas Fire Table

OPT-CLBCPR96	Hammered Copper
OPT-CLBCS96	Corten Steel
OPT-CLBSS96	Stainless Steel
OPT-CLBPC96	Powder Coat

- » Dimensions: 96" x 36"
- » Height: 24"
- » Burning Area: 66" x 10"
- » Weight: 235 lbs.
- » BTU: 65K
- » Sugg. Fire Glass: 25 lbs.

Optional Accessories

Unit	Canvas Cover	Stainless Lid	Glass Wind Guard
60" Calabasas	OPT-CVR-6028	OPT-RC1232	OPT-WG-3414
72" Calabasas	OPT-CVR-7228	OPT-RC1244	OPT-WG-4614
84" Calabasas	OPT-CVR-8436	OPT-RC1256	OPT-WG-5814
96" Calabasas	OPT-CVR-9636	OPT-RC1268	OPT-WG-7014



Maywood Collection

Includes access door for 20 lbs propane tank storage

60" x 28" Maywood Fire Table

OPT-MYWCPR60	Hammered Copper
OPT-MYWCS60	Corten Steel
OPT-MYWSS60	Stainless Steel
OPT-MYWPC60	Powder Coat

- » Dimensions: 60" x 28"
- » Height: 24"
- » Burning Area: 30" x 10"
- » Weight: 145 lbs.
- » BTU: 40K
- » Sugg. Fire Glass: 25 lbs.

72" x 28" Maywood Fire Table

OPT-MYWCPR72	Hammered Copper
OPT-MYWCS72	Corten Steel
OPT-MYWSS72	Stainless Steel
OPT-MYWPC72	Powder Coat

- » Dimensions: 72" x 28"
- » Height: 24"
- » Burning Area: 42" x 10"
- » Weight: 175 lbs.
- » BTU: 60K
- » Sugg. Fire Glass: 25 lbs.

84" x 36" Maywood Fire Table

OPT-MYWCPR84	Hammered Copper
OPT-MYWCS84	Corten Steel
OPT-MYWSS84	Stainless Steel
OPT-MYWPC84	Powder Coat

- » Dimensions: 84" x 36"
- » Height: 24"
- » Burning Area: 54" x 10"
- » Weight: 210 lbs.
- » BTU: 65K
- » Sugg. Fire Glass: 25 lbs.

96" x 36" Maywood Fire Table

OPT-MYWCPR96	Hammered Copper
OPT-MYWCS96	Corten Steel
OPT-MYWSS96	Stainless Steel
OPT-MYWPC96	Powder Coat

- » Dimensions: 96" x 36"
- » Height: 24"
- » Burning Area: 66" x 10"
- » Weight: 245 lbs.
- » BTU: 65K
- » Sugg. Fire Glass: 25 lbs.

Optional Accessories

Unit	Canvas Cover	Stainless Lid	Glass Wind Guard
60" Maywood	OPT-CVR-6030	OPT-RC1232	OPT-WG-3414
72" Maywood	OPT-CVR-7230	OPT-RC1244	OPT-WG-4614
84" Maywood	OPT-CVR-8436	OPT-RC1256	OPT-WG-5814
96" Maywood	OPT-CVR-9636	OPT-RC1268	OPT-WG-7014



Salinas Collection

Features access door for propane tank storage.

48" X 28" Salinas Fire Table

OPT-SALCS48 Match Lit
OPT-SALCS48FSML Flame Sense
OPT-SALCS48EKIT 110V Plug & Play

- » Dimensions: 48" x 28"
- » Height: 21"
- » Overhang: 3"
- » Burning Area: 30" x 10" x 2"
- » BTUs: 65,000
- » Suggested Fire Glass: 35 lbs.

60" X 28" Salinas Fire Table

OPT-SALCS60 Match Lit
OPT-SALCS60FSML Flame Sense
OPT-SALCS60EKIT 110V Plug & Play

- » Dimensions: 60" x 28"
- » Height: 21"
- » Overhang: 3"
- » Burning Area: 42" x 10" x 2"
- » BTUs: 65,000
- » Suggested Fire Glass: 45 lbs.



Optional Accessories

Unit	Canvas Cover	Stainless Lid	Glass Wind Guard
48" Salinas	OPT-CVR-4828	OPT-RC1232	OPT-WG-3414
60" Salinas	OPT-CVR-6028	OPT-RC1244	OPT-WG-4614



Alameda Collection

Includes 2 access doors for LP tank storage.

60" x 28" Alameda Fire Table

OPT-ALMCS60 Match Lit
OPT-ALMCS60EKIT 110V Plug & Play
OPT-ALMCS60FSML Flame Sense

- » Dimensions: 60" x 28"
- » Base Dimensions: 52" x 20"
- » Height: 30"
- » Burning Area: 30" x 10"
- » Weight: 150 lbs.
- » BTU: 65K
- » Sugg. Fire Glass: 30 lbs.

78" x 36" Alameda Fire Table

OPT-ALMCS78 Match Lit
OPT-ALMCS78EKIT 110V Plug & Play
OPT-ALMCS78FSML Flame Sense

- » Dimensions: 78" x 36"
- » Base Dimensions: 70" x 24"
- » Height: 30"
- » Burning Area: 48" x 10"
- » Weight: 200 lbs.
- » BTU: 65K
- » Sugg. Fire Glass: 50 lbs.



Optional Accessories

Unit	Canvas Cover	Stainless Lid	Glass Wind Guard
60" x 28" Alameda	OPT-CVR-6028	OPT-RC1232	OPT-WG-3614
78" x 28" Alameda	OPT-CVR-7836	OPT-RC1250	OPT-WG-5214



MATERIAL OPTIONS

- » Concrete top options found on page 63
- » Powder coated top options found on page 81

FIRE PITS & FIRE TABLES

All fire pits include: Fire Pan, Burner, Key Valve, Key, Gas Hoses, Lava Rock.
For Match Lit w/ Flame Sense add "-FSML" to part #. For 110V Ignition, add "-EKIT"

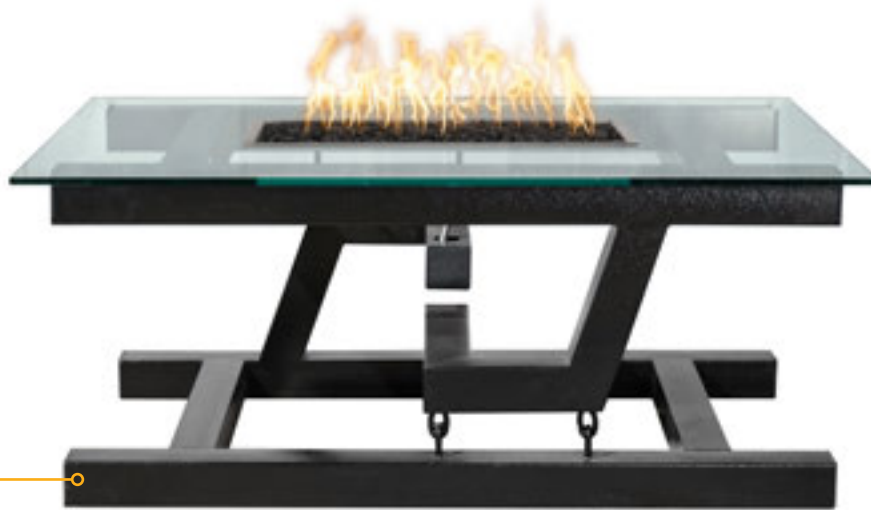

Newton Collection

1/2" Clear Tempered Glass Top.
Cannot store propane tank storage.

38" x 34" Newton Table - Floating Appearance
OPT-NWT138 Match Lit

52" x 34" Newton Table - Floating Appearance
OPT-NWT152 Match Lit

66" x 34" Newton Table - Floating Appearance
OPT-NWT166 Match Lit

38" x 34" Newton Table - W/ Chain Support
OPT-NWT238 Match Lit

- » Dimensions: 38" x 34"
- » Base: 36" x 28"
- » Height: 22"
- » Burning Area: 18" x 8" x 2"
- » Weight: 120 lbs.
- » BTU: 25K
- » Sugg. Fire Glass: 20 lbs.

52" x 34" Newton Table - W/ Chain Support
OPT-NWT252 Match Lit

- » Dimensions: 52" x 34"
- » Base: 48" x 28"
- » Height: 22"
- » Burning Area: 24" x 8" x 2"
- » Weight: 160 lbs.
- » BTU: 35K
- » Sugg. Fire Glass: 20 lbs.

66" x 34" Newton Table - W/ Chain Support
OPT-NWT266 Match Lit

- » Dimensions: 66" x 34"
- » Base: 60" x 28"
- » Height: 22"
- » Burning Area: 36" x 8" x 2"
- » Weight: 200 lbs.
- » BTU: 50K
- » Sugg. Fire Glass: 30 lbs.

Optional Accessories

Unit	Canvas Cover	Stainless Lid	Glass Wind Guard
38" Newton	OPT-CVR-3834	OPT-RC1020	OPT-WG-2212
52" Newton	OPT-CVR-5234	OPT-RC1026	OPT-WG-2812
66" Newton	OPT-CVR-6634	OPT-RC1038	OPT-WG-4012



Amina Collection

Includes 110V LED lights.
Cannot store propane tank storage

48" Amina Fire Pit

- OPT-AMI4824 Match Lit
- OPT-AMI4824FSML Flame Sense
- OPT-AMI4824E110 110V Plug & Play
- » Dimensions: 48" x 24"
- » Height: 15"
- » Burning Area: 30" x 10" x 2"
- » Weight: 130 lbs.
- » BTU: 40K
- » Sugg. Fire Glass: 50 lbs.

60" Amina Fire Pit

- OPT-AMI6024 Match Lit
- OPT-AMI6024FSML Flame Sense
- OPT-AMI6024E110 110V Plug & Play
- » Dimensions: 60" x 24"
- » Height: 15"
- » Burning Area: 42" x 10" x 2"
- » Weight: 165 lbs.
- » BTU: 40K
- » Sugg. Fire Glass: 50 lbs.

72" Amina Fire Pit

- OPT-AMI7224 Match Lit
- OPT-AMI7224FSML Flame Sense
- OPT-AMI7224E110 110V Plug & Play
- » Dimensions: 72" x 24"
- » Height: 15"
- » Burning Area: 54" x 10" x 2"
- » Weight: 200 lbs.
- » BTU: 40K
- » Sugg. Fire Glass: 50 lbs.



La Pinta Fire Pit

Includes 110V LED lights.
Cannot store propane tank storage

OPT-PNT72 Match Lit

- » Overall Dimensions: 72" x 34"
- » Overall Height: 57"
- » Table Dimensions: 72" x 34"
- » Table Base Dimensions: 64" x 30"
- » Table Top Overhang: 6"
- » Table Height: 24"
- » Table Burn Area: 52" x 14"
- » Boat Dimensions: 36" x 12"
- » Boat Height: 33"
- » BTU: 400,000
- » Material: Stainless Steel
- » Boat Finish:



Outback Fire Pit

This table features a cut-out design backed by a plate with the same powder coated finish
Concrete Top, Powder Coated Base.
Includes door for propane tank storage.

Cattle Ranch Version

OPT-OBCR6036PC Powder Coat Base
OPT-OBCR6036CS Corten Steel Base

Deer Country Version

OPT-OBDC6036PC Powder Coat Base
OPT-OBDC6036CS Corten Steel Base

- » Dimensions: 60" x 36"
- » Base: 42" x 22"
- » Height: 24"
- » Burning Area: 31" x 11"
- » Weight: 265 lbs.
- » BTU: 50K
- » Sugg. Fire Glass: 20 lbs.



CATTLE RANCH VERSION WITH
POWDER COAT BASE / COFFEE TOP SHOWN



DEER COUNTRY VERSION
CORTEN STEEL BASE / COFFEE TOP SHOWN



CATTLE RANCH VERSION
WITH BROWN TOP SHOWN



DEER COUNTRY VERSION
WITH BROWN TOP SHOWN

Outback Fire Pit

This table features a cut-out design backed by a plate with the same powder coated finish
Concrete Top, Powder Coated Base.
Includes door for propane tank storage.

Cattle Ranch Version

OPT-OBRRCR46 Match Lit
OPT-OBRRCR46FSML Flame Sense
OPT-OBRRCR46E110 110V Plug & Play

Deer Country Version

OPT-OBRDC46 Match Lit
OPT-OBRDC46FSML Flame Sense
OPT-OBRDC46E110 110V Plug & Play

- » Diameter: 46"
- » Base: 28"
- » Height: 24"
- » Burning Area: 21"
- » Weight: 210 lbs.
- » BTU: 65K
- » Sugg. Fire Glass: 20 lbs.



READY-TO-FINISH FIRE PITS

Our Ready-to-Finish Fire Pits are pre-built, fully assembled fire pits with a scratch board finish. This allows you to quickly install a fire pit with your choice of exterior finishing.

- » Match the fire pit with its surroundings
- » Eliminate the hassle of building a fire pit from scratch
- » Built from strong steel tubing to support almost any stone
- » Plug & Play installation to get in & out quicker
- » Includes all components necessary so you don't have to shop around.
- » Includes proper ventilation for safe operation
- » 24" Tall units include a stainless steel door for propane tank storage.

Everything we do can be customized, RTF Fire Pits are no different. We can change the following:

- » Gas Type - Liquid Propane or Natural Gas
- » Ignition Options - Match Lit, Flame Sense Ignition, 12V or 110V Ignition
- » Burning Media - Lava Rock or Glass
- » Ornamental Burners and Sculptures



Component Overview

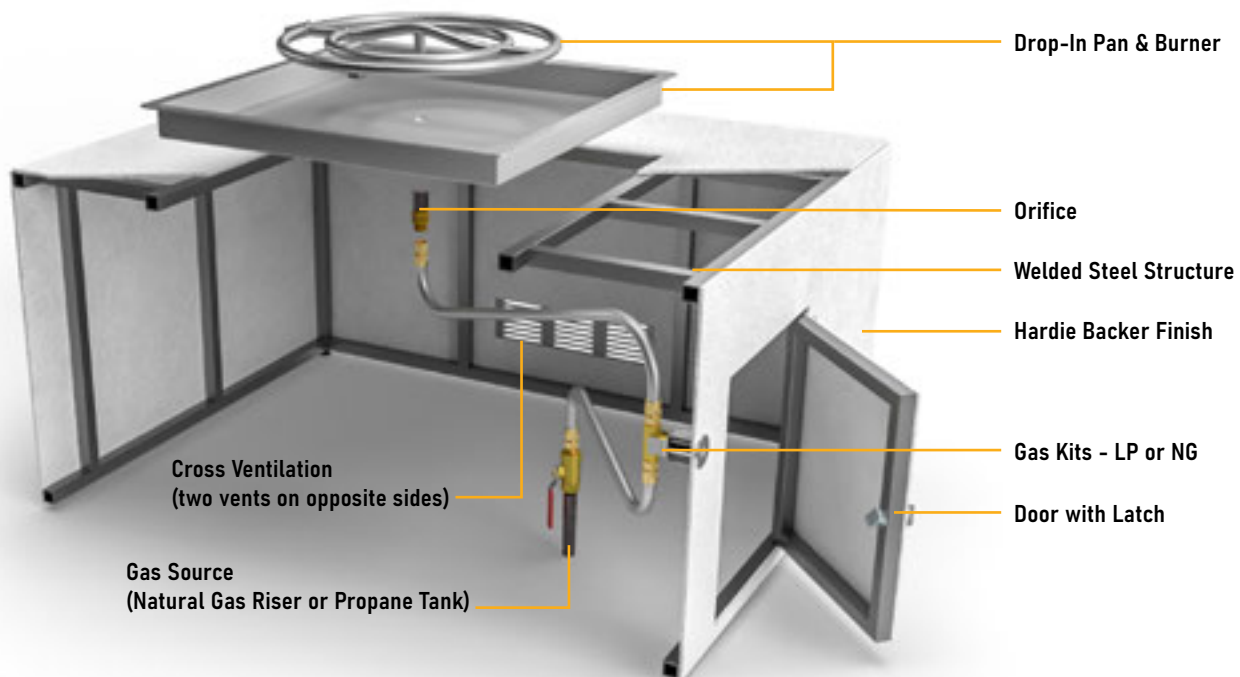



To add the Flame Sense with Spark Ignition Option, add "-FSML" to the part number.
To add the 110V Ignition Option, add "-EKIT" to the end of the part number



Square Pit Form - 16" Tall



PART #	L	W	H	BURN AREA	BURNER	BTU
OPT-S36PB	36"	36"	16"	18" x 18"	12"	65K
OPT-S48PB	48"	48"	16"	18" x 18"	12"	65K
OPT-S60PB	60"	60"	16"	24" x 24"	12"	65K
OPT-S72PB	72"	72"	16"	30" x 30"	18"	65K
OPT-S84PB	84"	84"	16"	36" x 36"	18"	65K

Square Pit Form - 24" Tall



PART #	L	W	H	BURN AREA	BURNER	BTU
OPT-S36DRPB	36"	36"	24"	18" x 18"	12"	65K
OPT-S48DRPB	48"	48"	24"	18" x 18"	12"	65K
OPT-S60DRPB	60"	60"	24"	24" x 24"	12"	65K
OPT-S72DRPB	72"	72"	24"	30" x 30"	18"	65K
OPT-S84DRPB	84"	84"	24"	36" x 36"	18"	65K

Square Table Form - 16" Tall



PART #	L	W	H	BASE	BURN AREA	BURNER	BTU
OPT-ST36PB	36"	36"	16"	20" x 20"	18" x 18"	12"	65K
OPT-ST48PB	48"	48"	16"	32" x 32"	18" x 18"	12"	65K
OPT-ST60PB	60"	60"	16"	44" x 44"	24" x 24"	12"	65K
OPT-ST72PB	72"	72"	16"	56" x 56"	30" x 30"	18"	65K
OPT-ST84PB	84"	84"	16"	68" x 68"	36" x 36"	18"	65K

Square Table Form - 24" Tall



PART #	L	W	H	BASE	BURN AREA	BURNER	BTU
OPT-ST36DRPB	36"	36"	24"	20" x 20"	18" x 18"	12"	65K
OPT-ST48DRPB	48"	48"	24"	32" x 32"	18" x 18"	12"	65K
OPT-ST60DRPB	60"	60"	24"	44" x 44"	24" x 24"	12"	65K
OPT-ST72DRPB	72"	72"	24"	56" x 56"	30" x 30"	18"	65K
OPT-ST84DRPB	84"	84"	24"	68" x 68"	36" x 36"	18"	65K

Rectangular Pit Form - 16" Tall



PART #	L	W	H	BURN AREA	BURNER	BTU
OPT-UFRT48PB	48"	24"	16"	36"x7"	30"	65K
OPT-UFRT60PB	60"	24"	16"	36"x7"	30"	65K
OPT-UFRT72PB	72"	24"	16"	36"x7"	30"	65K
OPT-UFRT84PB	84"	24"	16"	48"x7"	42"	65K
OPT-UFRT96PB	96"	24"	16"	48"x7"	42"	65K
OPT-UFRT108PB	108"	24"	16"	60"x7"	54"	65K

Rectangular Pit Form - 24" Tall



PART #	L	W	H	BURN AREA	BURNER	BTU
OPT-UFRT48DRPB	48"	24"	24"	36"x7"	30"	65K
OPT-UFRT60DRPB	60"	24"	24"	36"x7"	30"	65K
OPT-UFRT72DRPB	72"	24"	24"	36"x7"	30"	65K
OPT-UFRT84DRPB	84"	24"	24"	48"x7"	42"	65K
OPT-UFRT96DRPB	96"	24"	24"	48"x7"	42"	65K
OPT-UFRT108DRPB	108"	24"	24"	60"x7"	54"	65K



To add the Flame Sense with Spark Ignition Option, add **"-FSML"** to the part number.
 To add the 110V Ignition Option, add **"-EKIT"** to the end of the part number
 Natural Gas, add **-NG**. Liquid Propane, add **-LP**



Rectangular Table Form - 16" Tall

PART #	L	W	H	BURN AREA	BURNER	BTU
OPT-URST4816PB	48"	30"	18"	30"x8"	24"	65K
OPT-URST6016PB	60"	30"	18"	36"x8"	30"	65K
OPT-URST7216PB	72"	30"	18"	36"x8"	30"	65K
OPT-URST8416PB	84"	30"	18"	48"x8"	42"	65K
OPT-URST9616PB	96"	30"	18"	60"x8"	54"	65K
OPT-URST10816PB	108"	30"	18"	72"x8"	60"	65K



Rectangular Table Form - 24" Tall

PART #	L	W	H	BURN AREA	BURNER	BTU
OPT-URST48DRPB	48"	30"	24"	30"x8"	24"	65,000
OPT-URST60DRPB	60"	30"	24"	36"x8"	30"	65,000
OPT-URST72DRPB	72"	30"	24"	36"x8"	30"	65,000
OPT-URST84DRPB	84"	30"	24"	48"x8"	42"	65,000
OPT-URST96DRPB	96"	30"	24"	60"x8"	54"	65,000
OPT-URST108DRPB	108"	30"	24"	72"x8"	60"	65,000



Round Pit Form - 16" Tall

PART #	D	H	BURN AREA	BURNER	BTU
OPT-RL48PB	48"	16"	19"	12"	65,000
OPT-RL60PB	60"	16"	25"	12"	65,000
OPT-RL72PB	72"	16"	31"	18"	65,000
OPT-RL84PB	84"	16"	37"	18"	65,000



Round Pit Form With Door - 24" Tall

PART #	OD	H	BURN AREA	BURNER	BTU
OPT-RL48DRPB	48"	24"	19"	12"	65,000
OPT-RL60DRPB	60"	24"	25"	12"	65,000
OPT-RL72DRPB	72"	24"	31"	18"	65,000
OPT-RL84DRPB	84"	24"	37"	18"	65,000



Round Table Form - 16" Tall

PART #	OD	H	BASE	BURN AREA	BURNER	BTU
OPT-RRL48PB	48"	16"	32"	19"	12"	65K
OPT-RRL60PB	60"	16"	44"	25"	12"	65K
OPT-RRL72PB	72"	16"	56"	31"	18"	65K
OPT-RRL84PB	84"	16"	68"	37"	18"	65K



Round Table Form With Door - 24" Tall

PART #	OD	H	BASE	BURN AREA	BURNER	BTU
OPT-RRL48DRPB	48"	24"	32"	19"	12"	65K
OPT-RRL60DRPB	60"	24"	44"	25"	12"	65K
OPT-RRL72DRPB	72"	24"	56"	31"	18"	65K
OPT-RRL84DRPB	84"	24"	68"	37"	18"	65K

READY-TO-FINISH FIRE PIT FORMS

All fire pits include: Fire Pan, Burner, Key Valve, Key, Gas Hoses, Lava Rock.

 **LIFETIME WARRANTY ON ALL BURNERS**



To add the Flame Sense with Spark Ignition Option, add "-FSML" to the part number.
To add the 110V Ignition Option, add "-EKIT" to the end of the part number
Natural Gas, add **-NG**. Liquid Propane, add **-LP**



Octagon Pit Form - 16" Tall



PART #	L	W	H	BURN AREA	BURNER	BTU
OPT-OCTG36PB	36"	36"	16"	19"	12"	65K
OPT-OCTG48PB	48"	48"	16"	19"	12"	65K
OPT-OCTG60PB	60"	60"	16"	25"	12"	65K
OPT-OCTG72PB	72"	72"	16"	31"	18"	65K
OPT-OCTG84PB	84"	84"	16"	37"	18"	65K



Octagon Pit Form - 24" Tall

PART #	L	W	H	BURN AREA	BURNER	BTU
OPT-OCTG36DRPB	36"	36"	24"	19"	12"	65K
OPT-OCTG48DRPB	48"	48"	24"	19"	12"	65K
OPT-OCTG60DRPB	60"	60"	24"	25"	12"	65K
OPT-OCTG72DRPB	72"	72"	24"	31"	18"	65K
OPT-OCTG84DRPB	84"	84"	24"	37"	18"	65K



Coronado Form

PART #	L	W	H	BURN AREA	BURNER	BTU
OPT-UC60PB	60"	28"	15"	36" x 10"	36"	65K
OPT-UC72PB	72"	28"	15"	48" x 10"	42"	65K
OPT-UC84PB	84"	28"	15"	60" x 10"	60"	65K
OPT-UC96PB	96"	28"	15"	72" x 10"	72"	65K
OPT-UC108PB	108"	28"	15"	84" x 10"	84"	65K
OPT-UC120PB	120"	28"	15"	96" x 10"	96"	65K



Catalina Form

PART #	L	W	H	BURN AREA	BURNER	BTU
OPT-UCTDR60PB	60"	28"	24"	36" x 10"	30"	65K
OPT-UCTDR72PB	72"	28"	24"	48" x 10"	42"	65K
OPT-UCTDR84PB	84"	28"	24"	60" x 10"	54"	65K
OPT-UCTDR96PB	96"	28"	24"	72" x 10"	60"	65K
OPT-UCTDR108PB	108"	28"	24"	84" x 10"	72"	65K
OPT-UCTDR120PB	120"	28"	24"	96" x 10"	84"	65K



Custom RTF Fire Pit Form - 18' - Finished with Tile



RTF Fire Pit Form - 48" Round, 16" Tall
OPT-RL48PB



Concrete Pedestal

OPT-GFRCSTAND

- » Width: 16"
- » Length: 16"
- » Height: 21"
- » 14" x 16" Access Door
- » Bowl Not Included



Concrete LP Enclosure

OPT-LPHIDEGFRC

- » Width: 16"
- » Length: 16"
- » Height: 21"
- » 14" x 16" Access Door
- » Bowl Not Included



Copper LP Enclosure

OPT-LPHIDECPR

- » Width: 16"
- » Length: 16"
- » Height: 21"
- » Bowl Not Included
- » Removable Top



Corten Steel LP Enclosure

OPT-LPHIDECSS

- » Width: 16"
- » Length: 16"
- » Height: 21"
- » Bowl Not Included
- » Removable Top



Powder Coated LP Enclosure

OPT-LPHIDEPC

- » Width: 16"
- » Length: 16"
- » Height: 21"
- » Bowl Not Included
- » Removable Top



Stainless Steel LP Enclosure

OPT-LPHIDESS

- » Width: 16"
- » Length: 16"
- » Height: 21"
- » Bowl Not Included
- » Removable Top

When ordering, specify the color by adding the color code to the end of the Part #. **Example:** 27" Brown Sedona Water Bowl = OPT-27RWO-BRN

POWDER COAT COLOR OPTIONS

White -WHT	Gray -GRY	Pewter -PEW	Black -BLK	Silver Vein -SLV	Copper Vein -CPV	Java -JAV
---------------	--------------	----------------	---------------	---------------------	---------------------	--------------

CONCRETE COLOR OPTIONS

Black -BLK	Ash -ASH	Natural Gray -NGY	Gray -GRY	White Limestone -LIM	Chocolate -CHC	Chestnut -CST	Brown -BRN	Vanilla -VAN
Rustic Gray -RGR	Moss Stone -RMS	Rustic White -RWH	Coffee -RCF	Slate -MSL	Silver -MSV	Pearl -MPR	Bronze -MBR	Copper -MCP



FIRE TOWERS

T.O.P.'s Fire Tower line is a unique array of products that brings a one of a kind feeling to any backyard or outdoor space. These units are transportable and take up no more than 2' of floor space. Pair them to create a grandiose entry way.

◆ **Custom Sizes & Styles Available**

Have a custom design in mind? We can build it! Call or email us today to inquire

◆ **Small Foot Print**

The towers take up less space than a fire pit, and with its towering size, its sure to give an unforgettable impression.

◆ **No Assembly Required**

All fire towers come with its components assembled and hoses attached. Just connect the unit to gas and you're ready to operate your unit

◆ **Manufactured By Hand in the USA**

Each unit is made individually by hand from raw materials. T.O.P.'s craftsmen maintain high quality production standards to give you the best products



Granada Fire Tower

OPT-FTWR1 Match Lit
OPT-FTWR1EKIT Electronic Ignition

- » Dimensions: 22" X 22"
- » Height: 68"
- » Weight: 95 Lbs.
- » BTU: 40K
- » Material: Galvanized Steel
- » Finish: Powder-Coated
- » No Fire Glass Required
- » Items Included: Burner, Key Valve, Key, Gas Hoses.
- » Propane Tank Storage: Yes



Bastille Corten Tower

OPT-FTWR2 Match Lit
OPT-FTWR2EKIT Electronic Ignition

- » Dimensions: 24" x 24"
- » Height: 87"
- » Weight: 145 Lbs.
- » BTU: 40K
- » Material: Corten Steel
- » Finish: Weathered Corten Steel
- » No Fire Glass Required
- » Items Included: Burner, Key Valve, Key, Gas Hoses.
- » Propane Tank Storage: Yes



Bastille Copper Tower

OPT-FTWR3 Match Lit
OPT-FTWR3EKIT Electronic Ignition

- » Dimensions: 24" x 24"
- » Height: 87"
- » Weight: 128 Lbs.
- » BTU: 40K
- » Material: Copper
- » Finish: Hammered Patina
- » No Fire Glass Required
- » Items Included: Burner, Key Valve, Key, Gas Hoses.
- » Propane Tank Storage: Yes



High-Rise Fire Tower

28" x 28" Tower - Stainless Steel
 OPT-FTWR528 Match Lit
 OPT-FTWR528EKIT Electronic Ignition

- » Dimensions: 28" X 28"
- » Height: 72"
- » Weight: 275 Lbs.
- » BTU: 40K

42" x 42" Tower - Stainless Steel
 OPT-FTWR542 Match Lit
 OPT-FTWR542EKIT Electronic Ignition

- » Dimensions: 42" X 42"
- » Height: 72"
- » Weight: 275 Lbs.
- » BTU: 40K

- » Material: Stainless Steel
- » Finish: Brushed Finish
- » No Fire Glass Required
- » Items Included: Burner, Key Valve, Key, Gas Hoses, Glass Panels.
- » Propane Tank Storage: N/A



High-Rise Fire Tower

28" x 28" Tower - Black Powdercoat
 OPT-FTWR628 Match Lit
 OPT-FTWR628EKIT Electronic Ignition

- » Dimensions: 28" X 28"
- » Height: 72"
- » Weight: 275 Lbs.
- » BTU: 40K

42" x 42" Tower - Black Powdercoat
 OPT-FTWR642 Match Lit
 OPT-FTWR642EKIT Electronic Ignition

- » Dimensions: 42" X 42"
- » Height: 72"
- » Weight: 275 Lbs.
- » BTU: 40K

- » Material: Stainless Steel
- » Finish: Black Powder Coat
- » No Fire Glass Required
- » Items Included: Burner, Key Valve, Key, Gas Hoses, Glass Panels.
- » Propane Tank Storage: N/A



The Hay Stack Fire Tower

48" x 48" Tower - Black Powdercoat
 OPT-FTWR4 Match Lit
 OPT-FTWR4EKIT Electronic Ignition

- » Dimensions: 48" X 48"
- » Height: 72"
- » Weight: 450 Lbs.
- » BTU: 40K
- » Material: Stainless Steel
- » No Fire Glass Required
- » Items Included: Burner, Key Valve, Key, Gas Hoses, Sculpture
- » Propane Tank Storage: N/A

**Note: This was a custom design*



Our Self Contained Units come equipped with all necessary components for plug and play application. All units are ready to be finished with your choice of exterior such as stones, bricks, pavers, veneer, coping, etc. They may also be enjoyed as is. Each unit is constructed from marine grade stainless steel and finished with powder coat. Custom Sizes Available



60" Olympian - 4 Way Spill

OPT-OLR60 Match Lit
OPT-OLR60E Electronic Ignition

- » Overall Diameter: 60"
- » Overall Height: 36"

Water Tank

- » Diameter: 60"
- » Height: 22"
- » Basin Depth: 12"
- » Tank Includes: LED Lights (X4), 50 Ft² Water Filter, 24Hr Circulation Pump, Auto-Fill, Drain Valve.
- » Material: 316 Stainless Steel With Powder Coat Finish

4 - Way Copper Fire & Water Bowl

- » Diameter: 30"
- » Height: 12"
- » Base Diameter: 16"
- » Ignition: Match Lit / 12VAC Electronic Ignition
- » BTU: 65K
- » Sugg. Fire Glass: 50 Lbs.
- » Bowl Includes: Fire Pan, Burner, Gas Hose, Lava Rock.
- » Bowl Material: Copper - Hammered Patina Finish
- » LED Lights And Circulation Pump (Each Require 110V To Run)
- » 80 U.S. Gallons Required To Run Properly.

SELF CONTAINED FIRE & WATER FOUNTAINS



60" Round Olympian - 360° Spill

OPT-OLY60 Match Lit
OPT-OLY60E Electronic Ignition

- » Overall Diameter: 60"
- » Overall Height: 36"

Water Tank

- » Diameter: 60"
- » Height: 22"
- » Basin Depth: 12"
- » Tank Includes: LED Lights (X4), 50 Ft² Water Filter, 24Hr Circulation Pump, Auto-Fill, Drain Valve.
- » Material: 316 Stainless Steel With Powder Coat Finish

360° Copper Fire & Water Bowl

- » Diameter: 30"
- » Height: 12"
- » Base Diameter: 16"
- » Ignition: Match Lit / 12VAC Electronic Ignition
- » BTU: 65K
- » Sugg. Fire Glass: 25 Lbs.
- » Bowl Includes: Fire Pan, Burner, Gas Hose, Lava Rock.
- » Bowl Material: Copper - Hammered Patina Finish
- » LED Lights And Circulation Pump (Each Require 110V To Run)
- » 80 U.S. Gallons Required To Run Properly.



60" Square Olympian - 4 Way Spill

OPT-OLS60S Match Lit
OPT-OLS60SE Electronic Ignition

- » Overall Dimensions: 60" x 60" x 36"

Water Tank

- » Dimensions: 60" X 60"
- » Height: 22"
- » Basin Depth: 12"
- » Tank Includes: LED Lights (X4), 50 Ft² Water Filter, 24Hr Circulation Pump, Auto-Fill, Drain Valve.
- » Material: 316 Stainless Steel With Powder Coat Finish
- » LED Lights And Circulation Pump (Each Require 110V To Run)
- » 95 U.S. Gallons Required To Run Properly

4-Way Copper Fire & Water Bowl

- » Size: 30" X 30"
- » Height: 12"
- » Base: 20" X 20"
- » BTU: 65K
- » Sugg. Fire Glass: 30 Lbs.
- » Bowl Includes: Fire Pan, Burner, Gas Hose, Lava Rock.
- » Bowl Material: Copper - Hammered Patina Finish





72" Osiris

OPT-OSR60E 12V Electronic Ignition

- » Overall Height: 58"
- » Overall Diameter: 84"

Water Tank

- » Basin Diameter: 72"
- » Basin Depth: 10"
- » Overhang: 6"
- » Height: 22"
- » Tank Includes: LED Lights (X4), 50 Ft² Water Filter, 24Hr Circulation Pump, Auto-Fill, Drain Valve
- » Material: 316 Stainless Steel With Powder Coat Finish

Copper Fire Bowl

- » Diameter: 24"
- » Height: 12"
- » Ignition: 12VAC Electronic Ignition
- » BTU: 65K
- » No Fire Glass Or Lava Stone Required.
- » Bowl Includes: Fire Pan, Burner, Gas Hose, Lava Rock.
- » Bowl Material: Copper - Hammered Patina Finish
- » LED Lights And Circulation Pump (Each Require 110V To Run)
- » 120 U.S. Gallons Required To Run Properly.



60" Olympia with 360° Sedona

OPT-OLYSED60 Match Lit
OPT-OLYSED60E Electronic Ignition

- » Overall Diameter: 60"
- » Overall Height: 38"

38" 360° Concrete Fire & Water Bowl

- » Size: 38"
- » Height: 16"
- » Base: 18"
- » BTU: 45K
- » Sugg. Glass: 16lbs.
- » Bowl Includes: Fire Pan, Burner, Gas Hose, Lava Rock.
- » Bowl Material: GFRC Concrete



Water Tank

- » Diameter: 60"
- » Height: 22"
- » Basin Depth: 12"
- » Tank Includes: LED Lights (X4), 50 Ft² Water Filter, 24 hr. Circulation Pump, Auto-Fill, Drain Valve
- » LED Lights And Circulation Pump (Each Require 110V To Run)
- » 95 U.S. Gallons Required To Run Properly.

SELF CONTAINED UNITS

72" Olympia 3-Way Spill

OPT-OLY723W Match Lit
OPT-OLY723WE Electronic Ignition

- » Overall Height: 58"
- » Overall Diameter: 72"

Water Tank

- » Basin Diameter: 72"
- » Basin Depth: 10"
- » Overhang: 6"
- » Height: 22"
- » Tank Includes: LED Lights (X4), 50 Ft² Water Filter, 24Hr Circulation Pump, Auto-Fill, Drain Valve
- » Material: 316 Stainless Steel With Powder Coat Finish

Copper Fire Bowl

- » Diameter: 24"
- » Height: 12"
- » Ignition: Match Lit / 12VAC Electronic Ignition
- » BTU: 65K
- » No Fire Glass Or Lava Stone Required.
- » Bowl Includes: Fire Pan, Burner, Gas Hose, Lava Rock.
- » Bowl Material: Copper - Hammered Patina Finish
- » LED Lights And Circulation Pump (Each Require 110V To Run)
- » 120 U.S. Gallons Required To Run Properly.



Custom Sizes Available



10' x 2' Self Contained Water Fall over Fire Feature with Planter.
Riverside Food Lab. Riverside, California.

All Torch Heads, TOP Torches and TopLite Torches are all hand made from stainless steel. They are compatible with either natural gas or liquid propane and operate at 20K BTU/hr. Torches are for outdoor use only and should not be used during rain. Available in match lit ignition options only.

2 Types of Bases & Mounting Options



TOP Torch Base

- » Mounts on 2½ hollow post
- » Built-in needle valve for precise flame adjustment.
- » 3/8" flared gas connection
- » 20K BTUs



TopLite Torch Base

- » Mounts on ½" NPT gas pipe
- » Speedy Installation
- » On/Off Valve
- » 20K BTUs

All of T.O.P's torches are made with 304 Stainless Steel. This protects them from the constant heating & cooling down which can break down other metals. Stainless Steel also prevents corrosion which can be caused by the natural elements.

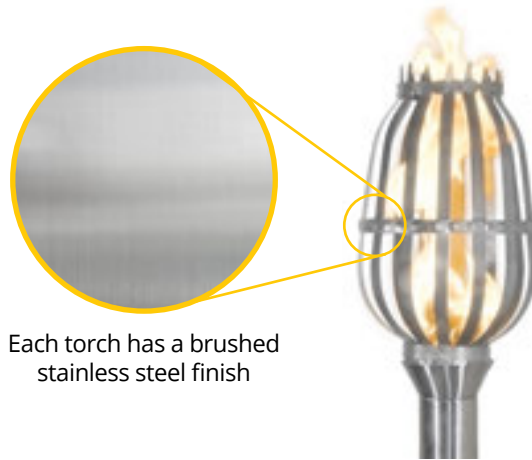

Each torch has a brushed stainless steel finish

Torch Head Part Numbers

STYLE	ORIGINAL TOP TORCHES	TOP-LITE TORCHES	DIAMETER	HEIGHT	STYLE	ORIGINAL TOP TORCHES	TOP-LITE TORCHES	DIAMETER	HEIGHT
Ellipse	OPT-TT1M	OPT-TCH1SS	3 ¾"	14"	Honeycomb	OPT-TT14M	OPT-TCH14SS	3 ¾"	14"
Globe	OPT-TT2M	OPT-TCH2SS	11"	14"	Havana	OPT-TT15M	OPT-TCH15SS	3 ¾"	14"
Trojan	OPT-TT3M	OPT-TCH3SS	8"	14"	Woven	OPT-TT16M	OPT-TCH16SS	3 ¾"	14"
Vent	OPT-TT4M	OPT-TCH4SS	3 ¾"	14"	Coral	OPT-TT17M	OPT-TCH17SS	3 ¾"	14"
Hercules	OPT-TT5M	OPT-TCH5SS	8"	14"	Diamond	OPT-TT18M	OPT-TCH18SS	3 ¾"	14"
Lantern	OPT-TT6M	OPT-TCH6SS	8"	14"	Cubist	OPT-TT19M	OPT-TCH19SS	3 ¾"	14"
Roman	OPT-TT7M	OPT-TCH7SS	8"	14"	Hawi	OPT-TT20M	OPT-TCH20SS	3 ¾"	14"
Flower	OPT-TT8M	OPT-TCH8SS	10"	14"	Comet	OPT-TT21M	OPT-TCH21SS	3 ¾"	14"
Basket	OPT-TT9M	OPT-TCH9SS	8"	14"	Shotgun	OPT-TT22M	OPT-TCH22SS	3 ¾"	14"
Urn	OPT-TT10M	OPT-TCH10SS	9"	14"	Sunshine	OPT-TT23M	OPT-TCH23SS	3 ¾"	14"
Gothic	OPT-TT11M	OPT-TCH11SS	9"	14"	Cyclone	OPT-TT24M	OPT-TCH24SS	3 ¾"	14"
Spiral	OPT-TT12M	OPT-TCH12SS	7"	14"	Tiki	OPT-TT25M	OPT-TCH25SS	3 ¾"	14"
Tropical	OPT-TT13M	OPT-TCH13SS	3 ¾"	14"					





Ellipse

Globe

Trojan

Vent

Hercules

Lantern



Roman

Flower

Basket

Urn

Gothic

Spiral



Tropical

Honeycomb

Havana

Woven

Coral

Diamond



Cubist

Hawi

Comet

Shotgun

Sunshine

Cyclone

Tiki

TOP Torch & Post Complete Kit

The TOP Torch & Post Kit comes with all components needed to install and operate a single TOP Torch. With this kit, there is no need to order all components à la carte!

Liquid Propane Kits Include

- » Torch Head
- » In Ground Post
- » Anchoring Post
- » LP Regulator (8')
- » Deck Post

Natural Gas Kits Include

- » Torch Head
- » In Ground Post
- » Anchoring Post
- » SS Whistle Free Hose (1/2")
- » Deck Post



STYLE	LIQUID PROPANE	NATURAL GAS
Ellipse	OPT-TPK1LP	OPT-TPK1NG
Globe	OPT-TPK2LP	OPT-TPK2NG
Trojan	OPT-TPK3LP	OPT-TPK3NG
Vent	OPT-TPK4LP	OPT-TPK4NG
Hercules	OPT-TPK5LP	OPT-TPK5NG
Lantern	OPT-TPK6LP	OPT-TPK6NG
Roman	OPT-TPK7LP	OPT-TPK7NG
Flower	OPT-TPK8LP	OPT-TPK8NG
Basket	OPT-TPK9LP	OPT-TPK9NG
Urn	OPT-TPK10LP	OPT-TPK10NG
Gothic	OPT-TPK11LP	OPT-TPK11NG
Spiral	OPT-TPK12LP	OPT-TPK12NG
Tropical	OPT-TPK13LP	OPT-TPK13NG
Honeycomb	OPT-TPK14LP	OPT-TPK14NG
Havana	OPT-TPK15LP	OPT-TPK15NG
Box Weave	OPT-TPK16LP	OPT-TPK16NG
Coral	OPT-TPK17LP	OPT-TPK17NG
Diamond	OPT-TPK18LP	OPT-TPK18NG
Cubist	OPT-TPK19LP	OPT-TPK19NG
Hawi	OPT-TPK20LP	OPT-TPK20NG
Comet	OPT-TPK21LP	OPT-TPK21NG
Shotgun	OPT-TPK22LP	OPT-TPK22NG
Sunshine	OPT-TPK23LP	OPT-TPK23NG
Cyclone	OPT-TPK24LP	OPT-TPK24NG
Tiki	OPT-TPK25LP	OPT-TPK25NG

In-Ground Post

OPT-TTBP

- » **ONLY compatible with TOP Torches**
- » NOT compatible with TopLite Torches
- » Finish: Black Powder Coat
- » Diameter: 2 1/2"
- » Total Height: 80"
- » 16" Anchor Post
- » 68" Post



Access Hole

NG - Lets you install an in-line manual shut off valve

LP - Lets you run an LP regulator hose out and to the propane tank



Propane Tank Cover

OPT-LPCOVER

- » Black Canvas Cover.
- » For standard 20 lbs LP Tank



Deck Post Mount

OPT-TTDP

- » **Compatible with In-Ground Post only (Above)**
- » Designed to aid in mounting the post on any hard surface (wood, concrete, etc.)
- » Material: Steel
- » Finish: Black Powder Coat
- » Opening: 2 5/8"
- » Post sold separately



Top Torch Column Mount

OPT-TTCM

- » **ONLY compatible with TOP Torches**
- » NOT compatible with TopLite Torches
- » Material: Steel
- » Finish: Black Powder Coat
- » Length/Width: 8"
- » Height: 8"



TopLite Torch Stand - Liquid Propane

OPT-TSTNDLP

- » Powder Coated Steel
- » Footprint: 18" x 18"
- » Torch to Torch Distance: 36"
- » Total Height: 78"
- » Gas Connection: 1/2"
- » Includes SS Whistle Free Hose

TopLite Torch Stand - Natural Gas

OPT-TSTNDNG

- » Powder Coated Steel
- » Footprint: 18" x 18"
- » Torch to Torch Distance: 36"
- » Total Height: 78"
- » Gas Connection: 1/2"
- » Includes LP Regulator



THE OUTDOOR PLUS

Pans, Burners, Gas Kits & Other Components



THE OUTDOOR PLUS BURNERS

Works with LP or NG

All of TOP's burners are suitable for any fire pit or fire bowl whether they are natural gas or liquid propane

Water Runoff Protection

The inlets on all TOP burners are raised and tapered so that if water does enter the burner, it will not enter the gas line.

Multiple Drain Holes

Each burner has multiple drain holes to release any water that may enter the burner through the flame holes.

Drain Hole Tab

With the The drain holes pointed to the side, we add a tab to redirect the flame upward to retain the intended flame pattern. Other burners have drain holes which create an unappealing flame

.065 Wall Thickness & Stainless Steel Construction

The wall thickness of T.O.P.'s stainless steel burners is greater than most burners on the market. Along with the 304 stainless steel construction. This ensures a long burner life and resists warping.

Individually Drilled Holes

Improved flame pattern and gas flow compared to punched holes

Downward Taper

The Downward taper prevents water from traveling up the cross member and entering the gas line.



Drain Holes on Side

Prevents water from building up inside the burner and potentially entering the gas line

Manufactured By Hand

This ensures that each burner is inspected by multiple people along the assembly line and meets T.O.P.'s high quality standards

Anchoring Tabs

These tabs come with every burner to give you the option to anchor it onto the fire pan.

Using Propane? Make Sure You Use an LP Air Mix Orifice

Compared to Natural Gas (NG), Propane Gas (LP) is much more volatile and requires more oxygen for combustion.

Because of this, an air mixer is installed under the burner to lean out the gas, and minimize propane soot.



All Outdoor Plus Kits Come With Orifices

All of T.O.P.'s burner kits & fire pits include an orifice which helps regulate & save gas.

The LP air mix orifice includes an adjustable nut to control the amount of air that is mixed with the gas



LP ORIFICE



NG ORIFICE

BUILD YOUR OWN FIRE PIT

If you are building a fire pit from scratch using paver blocks, use these components to eliminate the hassle of figuring out which components you'll need. All you need to know is the desired fire pit opening and find a flat pan kit to fit.

'Build Your Own' Fire Pit Checklist

- 1 Choose any desired Pan & Burner Kit
- 2 Find perimeter of Fire Pit Area and get the required Z-Brackets for any flat pan application
- 3 Get the Paver Bracket with Key Valve and Gas Line. Choose either LP or NG (Paver brackets are width adjustable from 8" - 14")
- 4 Don't forget your ventilation (Prevents dangerous gas buildup inside the enclosure)
- 5 Finally, your access doors to hide away a propane tank or to make future maintenance a breeze! Optional but highly recommended

Completed Fire Pit

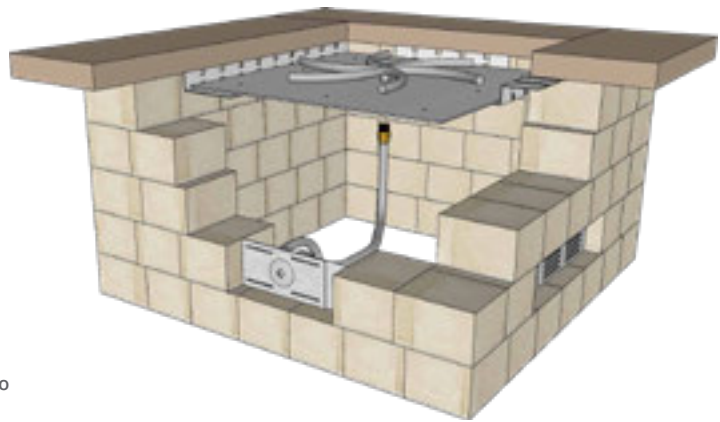

Gas Kit with Paver Bracket

The Paver Bracket makes it easy to install a key valve onto any DIY paver/brick fire pit. Simply install it in place of a paver. Adhere using a couple of anchors or adhesive.
Height: 3.875" ; **Width:** Min - 8" , Max - 14" ; **Depth:** 4"

NG Gas Kit with Paver Bracket

OPT-PB256NG - Natural Gas
 OPT-PB256NGHC - Natural Gas over 300K BTU
 » Includes: Adjustable SS Bracket, Key Valve, Turn Key, 24" 1/2" Whistle Free Hoses (2x), NG Orifice

LP Gas Kit with Paver Bracket

OPT-PB256LP - Liquid Propane
 OPT-PB256LPHC - Liquid Propane over 300K BTU
 » Includes: Adjustable SS Bracket, Key Valve, Turn Key, 24" 3/8" Whistle Free Hose, LP Regulator, LP Air Mix Orifice

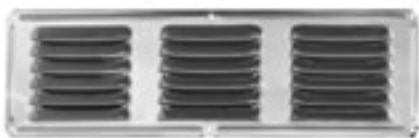

Rectangular Vents

- » Aluminum Vent for all fire pits
- » Flush Surface Mount

5" x 4" Vent OPT-VENT54
16" x 4" Vent OPT-VENT164

Custom sizes available



Access Door

- » Doors come equipped with a lock latch.
- » Includes holes for added ventilation
- » 304 Stainless Steel
- » Brushed Finish.

14" x 17" Door OPT-ADSS1417
8" x 8" Door OPT-ADSS88
10" x 10" Door OPT-ADSS1010
12" x 12" Door OPT-ADSS1212

Custom sizes available



Round Vents

- » Aluminum Vent for all fire pits
- » Inserts into 2", 3", or 4" hole
- » Depth: 3/4"

2" Vent OPT-RVENT2
3" Vent OPT-RVENT3
4" Vent OPT-RVENT4

Custom sizes available

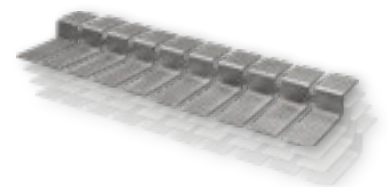

24" Z-Mounting Brackets

OPT-ZBRKT

- » Z-Brackets are designed to ease the installation of flat pan kits in DIY Fire Pits
- » Brackets are flexible to suit both rectangle & round fire pit's burn areas
- » Made of 304 Stainless Steel
- » **Length:** 24" ; **Height:** 2" ; **Depth:** 5"



Custom Stainless Steel Vents

We can make vents for your fire feature in any shape and any size, and even with a custom design. Call or email us today to inquire about custom vents.



The Patented Bullet Burner's eliminate the need for an additional LP air mixer. Suitable for either natural gas or liquid propane applications. Electronic ignition systems require 10" clearance below the pan. 110V Ignition System Kits use a 3-prong grounded plug.

BURNER SIZE GUIDE: **M** = Double Inlet and uses manifold that adds 5" in height below the pan ; **2R** = 2 Rings ; **3R** = 3 Rings ; **4R** = 4 Rings



Round Flat Pan & Bullet Burner

ITEM	PAN & BURNER ONLY	FLAME SENSE MATCH LIT CERTIFIED	FLAME SENSE W/ SPARK IGNITION	ELECTRONIC 12V CSA CERTIFIED	ELECTRONIC 110V CSA CERTIFIED	BURNER SIZE	GAS INLET	BTU
18" Pan Kit - A	OPT-BFP18R	OPT-BFP18RFSML	OPT-BFP18RFSEN	OPT-BFP18RE12	OPT-BFP18RE110	8"	½"	50,000
18" Pan Kit - B	OPT-BFP182R	OPT-BFP182RFSML	OPT-BFP182RFSEN	OPT-BFP182RE12	OPT-BFP182RE110	12"	½"	75,000
24" Pan Kit	OPT-BFP24R	OPT-BFP24RFSML	OPT-BFP24RFSEN	OPT-BFP24RE12	OPT-BFP24RE110	18"	½"	110,000
30" Pan Kit	OPT-BFP30R	N/A	OPT-BFP30RFSEN	OPT-BFP30RE12	OPT-BFP30RE110	24"	½"	145,000
36" Pan Kit	OPT-BFP36R	N/A	OPT-BFP36RFSEN	OPT-BFP36RE12	OPT-BFP36RE110	30"	¾"	180,000
48" Pan Kit	OPT-BFP48R	N/A	N/A	OPT-BFP48RE12	OPT-BFP48RE110	36"	¾"	220,000
60" Pan Kit	OPT-BFP60R	N/A	N/A	OPT-BFP60RE12	OPT-BFP60RE110	48"	¾"	385,000



Square Flat Pan & Bullet Burner

ITEM	PAN & BURNER ONLY	FLAME SENSE MATCH LIT CERTIFIED	FLAME SENSE W/ SPARK IGNITION	ELECTRONIC 12V CSA CERTIFIED	ELECTRONIC 110V CSA CERTIFIED	BURNER SIZE	GAS INLET	BTU
18" Pan Kit - A	OPT-BFP18S	OPT-BFP18SFSML	OPT-BFP18SFSEN	OPT-BFP18SE12	OPT-BFP18SE110	8"	½"	50,000
18" Pan Kit - B	OPT-BFP182S	OPT-BFP182SFSML	OPT-BFP182SFSEN	OPT-BFP182SE12	OPT-BFP182SE110	12"	½"	75,000
24" Pan Kit	OPT-BFP24S	OPT-BFP24SFSML	OPT-BFP24SFSEN	OPT-BFP24SE12	OPT-BFP24SE110	18"	½"	110,000
30" Pan Kit	OPT-BFP30S	N/A	OPT-BFP30SFSEN	OPT-BFP30SE12	OPT-BFP30SE110	24"	½"	145,000
36" Pan Kit	OPT-BFP36S	N/A	OPT-BFP36SFSEN	OPT-BFP36SE12	OPT-BFP36SE110	30"	¾"	180,000
48" Pan Kit	OPT-BFP48S	N/A	N/A	OPT-BFP48SE12	OPT-BFP48SE110	36"	¾"	220,000
60" Pan Kit	OPT-BFP60S	N/A	N/A	OPT-BFP60SE12	OPT-BFP60SE110	48"	¾"	385,000

MORE ELECTRONIC IGNITION ACCESSORIES ON PAGES 155

MORE GAS ACCESSORIES ON PAGES 158



FLAT PAN BRASS BULLET BURNER KITS

PATENTED DESIGN

LIFETIME WARRANTY ON ALL BURNERS

The Patented Bullet Burner's eliminate the need for an additional LP air mixer. Suitable for either natural gas or liquid propane applications. Electronic ignition systems require 10" clearance below the pan. 110V Ignition System Kits use a 3-prong grounded plug.

BURNER SIZE GUIDE: **M** = Double Inlet and uses manifold that adds 5" in height below the pan ; **2R** = 2 Rings ; **3R** = 3 Rings ; **4R** = 4 Rings



Rectangular Flat Pan & Linear Bullet Burner

ITEM	PAN & BURNER ONLY	FLAME SENSE MATCH LIT CERTIFIED	FLAME SENSE W/ SPARK IGNITION	ELECTRONIC 12V CSA CERTIFIED	ELECTRONIC 110V CSA CERTIFIED	BURNER SIZE	GAS INLET	BTU
24"x8" Pan Kit	OPT-BFP24RT	OPT-BFP24RTFSML	OPT-BFP24RTFSEN	OPT-BFP24RTE12	OPT-BFP24RTE110	18"	½"	40,000
36"x8" Pan Kit	OPT-BFP36RT	OPT-BFP36RTFSML	OPT-BFP36RTFSEN	OPT-BFP36RTE12	OPT-BFP36RTE110	30"	½"	50,000
48"x8" Pan Kit	OPT-BFP48RT	OPT-BFP48RTFSML	OPT-BFP48RTFSEN	OPT-BFP48RTE12	OPT-BFP48RTE110	42"	½"	75,000
60"x8" Pan Kit	OPT-BFP60RT	OPT-BFP60RTFSML	OPT-BFP60RTFSEN	OPT-BFP60RTE12	OPT-BFP60RTE110	48"	½"	100,000
72"x8" Pan Kit	OPT-BFP72RT	OPT-BFP72RTFSML	OPT-BFP72RTFSEN	OPT-BFP72RTE12	OPT-BFP72RTE110	60"	½"	120,000
84"x8" Pan Kit	OPT-BFP84RT	N/A	N/A	OPT-BFP84RTE12	OPT-BFP84RTE110	72"	½"	145,000
96"x8" Pan Kit	OPT-BFP96RT	N/A	N/A	OPT-BFP96RTE12	OPT-BFP96RTE110	84"	¾"	170,000



Rectangular Flat Pan & 'H' Bullet Burner

ITEM	PAN & BURNER ONLY	FLAME SENSE MATCH LIT CERTIFIED	FLAME SENSE W/ SPARK IGNITION	ELECTRONIC 12V CSA CERTIFIED	ELECTRONIC 110V CSA CERTIFIED	BURNER SIZE	GAS INLET	BTU
24"x12" Pan Kit	OPT-BFP1224R	OPT-BFP1224RFSML	OPT-BFP1224RFSEN	OPT-BFP1224RE12	OPT-BFP1224RE110	18" x 6"	½"	85,000
36"x12" Pan Kit	OPT-BFP1236R	OPT-BFP1236RFSML	OPT-BFP1236RFSEN	OPT-BFP1236RE12	OPT-BFP1236RE110	24" x 6"	½"	110,000
48"x12" Pan Kit	OPT-BFP1248R	OPT-BFP1248RFSML	OPT-BFP1248RFSEN	OPT-BFP1248RE12	OPT-BFP1248RE110	36" x 6"	½"	160,000
60"x12" Pan Kit	OPT-BFP1260R	N/A	N/A	OPT-BFP1260RE12	OPT-BFP1260RE110	48" x 6"	½"	205,000
72"x12" Pan Kit	OPT-BFP1272R	N/A	N/A	OPT-BFP1272RE12	OPT-BFP1272RE110	60" x 6" (M)	½"	255,000
84"x12" Pan Kit	OPT-BFP1284R	N/A	N/A	OPT-BFP1284RE12	OPT-BFP1284RE110	72" x 6" (M)	½"	30,000
96"x12" Pan Kit	OPT-BFP1296R	N/A	N/A	OPT-BFP1296RE12	OPT-BFP1296RE110	84" x 6" (M)	½"	350,000





Bullet Burner's eliminate the need for an additional LP air mixer. Suitable for either natural gas or liquid propane applications. Pans have 1" Lip & 2" Height. Electronic ignition requires 10" clearance below the pan. 110V Ignition System Kits use a 3-prong grounded plug.

BURNER SIZE GUIDE: **M** = Double Inlet and uses manifold that adds 5" in height below the pan ; **2R** = 2 Rings ; **3R** = 3 Rings ; **4R** = 4 Rings



SS Round Drop In Pan & Bullet Burner

ITEM	PAN & BURNER ONLY	FLAME SENSE MATCH LIT CERTIFIED	FLAME SENSE W/ SPARK IGNITION	ELECTRONIC 12V CSA CERTIFIED	ELECTRONIC 110V CSA CERTIFIED	BURNER SIZE	GAS INLET	BTU
13" Pan Kit	OPT-BP13RD	OPT-BP13RDFSML	OPT-BP13RDFSSEN	OPT-BP13RDE12	OPT-BP13RDE110	8"	½"	50,000
19" Pan Kit	OPT-BP19RD	OPT-BP19RDFSML	OPT-BP19RDFSSEN	OPT-BP19RDE12	OPT-BP19RDE110	12"	½"	75,000
25" Pan Kit	OPT-BP25RD	OPT-BP25RDFSML	OPT-BP25RDFSSEN	OPT-BP25RDE12	OPT-BP25RDE110	18"	½"	110,000
31" Pan Kit	OPT-BP31RD	N/A	OPT-BP31RDFSSEN	OPT-BP31RDE12	OPT-BP31RDE110	24"	½"	145,000
37" Pan Kit	OPT-BP37RD	N/A	N/A	OPT-BP37RDE12	OPT-BP37RDE110	30"	¾"	180,000
43" Pan Kit	OPT-BP43RD	N/A	N/A	OPT-BP43RDE12	OPT-BP43RDE110	36"	¾"	220,000



SS Square Drop In Pan & Bullet Burner

ITEM	PAN & BURNER ONLY	FLAME SENSE MATCH LIT CERTIFIED	FLAME SENSE W/ SPARK IGNITION	ELECTRONIC 12V CSA CERTIFIED	ELECTRONIC 110V CSA CERTIFIED	BURNER SIZE	GAS INLET	BTU
12" Pan Kit	OPT-BP12SD	OPT-BP12SDFSML	OPT-BP12SDFSSEN	OPT-BP12SDE12	OPT-BP12SDE110	8"	½"	50,000
18" Pan Kit	OPT-BP18SD	OPT-BP18SDFSML	OPT-BP18SDFSSEN	OPT-BP18SDE12	OPT-BP18SDE110	12"	½"	75,000
24" Pan Kit	OPT-BP24SD	OPT-BP24SDFSML	OPT-BP24SDFSSEN	OPT-BP24SDE12	OPT-BP24SDE110	18"	½"	110,000
30" Pan Kit	OPT-BP30SD	N/A	OPT-BP30SDFSSEN	OPT-BP30SDE12	OPT-BP30SDE110	24"	½"	145,000
36" Pan Kit	OPT-BP36SD	N/A	N/A	OPT-BP36SDE12	OPT-BP36SDE110	30"	¾"	180,000
48" Pan Kit	OPT-BP48SD	N/A	N/A	OPT-BP48SDE12	OPT-BP48SDE110	36"	¾"	220,000



DROP-IN PAN BRASS BULLET BURNER KITS

PATENTED DESIGN

LIFETIME WARRANTY ON ALL BURNERS

Bullet Burner's eliminate the need for an additional LP air mixer. Suitable for either natural gas or liquid propane applications. Pans have 1" Lip & 2" Height. Electronic ignition requires 10" clearance below the pan. 110V Ignition System Kits use a 3-prong grounded plug.

BURNER SIZE GUIDE: **M** = Double Inlet and uses manifold that adds 5" in height below the pan ; **2R** = 2 Rings ; **3R** = 3 Rings ; **4R** = 4 Rings



SS Rectangular Drop In Pan & Linear Bullet Burner

ITEM	PAN & BURNER ONLY	FLAME SENSE MATCH LIT CERTIFIED	FLAME SENSE W/ SPARK IGNITION	ELECTRONIC 12V CSA CERTIFIED	ELECTRONIC 110V CSA CERTIFIED	BURNER SIZE	GAS INLET	BTU
24"x8" Pan Kit	OPT-BP824RD	OPT-BP824RDFSML	OPT-BP824RDFSEN	OPT-BP824RDE12	OPT-BP824RDE110	18"	½"	40,000
36"x8" Pan Kit	OPT-BP836RD	OPT-BP836RDFSML	OPT-BP836RDFSEN	OPT-BP836RDE12	OPT-BP836RDE110	24"	½"	50,000
48"x8" Pan Kit	OPT-BP848RD	OPT-BP848RDFSML	OPT-BP848RDFSEN	OPT-BP848RDE12	OPT-BP848RDE110	36"	½"	75,000
60"x8" Pan Kit	OPT-BP860RD	OPT-BP860RDFSML	OPT-BP860RDFSEN	OPT-BP860RDE12	OPT-BP860RDE110	48"	½"	100,000
72"x8" Pan Kit	OPT-BP872RD	OPT-BP872RDFSML	OPT-BP872RDFSEN	OPT-BP872RDE12	OPT-BP872RDE110	60"	¾"	120,000
84"x8" Pan Kit	OPT-BP884RD	N/A	N/A	OPT-BP884RDE12	OPT-BP884RDE110	72"	¾"	145,000
96"x8" Pan Kit	OPT-BP896RD	N/A	N/A	OPT-BP896RDE12	OPT-BP896RDE110	84"	¾"	170,000



SS Rectangular Drop In Pan & 'H' Bullet Burner

ITEM	PAN & BURNER ONLY	FLAME SENSE MATCH LIT CERTIFIED	FLAME SENSE W/ SPARK IGNITION	ELECTRONIC 12V CSA CERTIFIED	ELECTRONIC 110V CSA CERTIFIED	BURNER SIZE	GAS INLET	BTU
24"x12" Pan Kit	OPT-BP1224RD	OPT-BP1224RDFSML	OPT-BP1224RDFSEN	OPT-BP1224RDE12	OPT-BP1224RDE110	18" x 6"	½"	85,000
36"x12" Pan Kit	OPT-BP1236RD	OPT-BP1236RDFSML	OPT-BP1236RDFSEN	OPT-BP1236RDE12	OPT-BP1236RDE110	24" x 6"	½"	110,000
48"x12" Pan Kit	OPT-BP1248RD	OPT-BP1248RDFSML	OPT-BP1248RDFSEN	OPT-BP1248RDE12	OPT-BP1248RDE110	36" x 6"	½"	160,000
60"x12" Pan Kit	OPT-BP1260RD	N/A	N/A	OPT-BP1260RDE12	OPT-BP1260RDE110	48" x 6"	½"	205,000
72"x12" Pan Kit	OPT-BP1272RD	N/A	N/A	OPT-BP1272RDE12	OPT-BP1272RDE110	60" x 6" (M)	¾"	255,000
84"x12" Pan Kit	OPT-BP1284RD	N/A	N/A	OPT-BP1284RDE12	OPT-BP1284RDE110	72" x 6" (M)	½"	300,000
96"x12" Pan Kit	OPT-BP1296RD	N/A	N/A	OPT-BP1296RDE12	OPT-BP1296RDE110	84" x 6" (M)	½"	300,000

MORE ELECTRONIC IGNITION ACCESSORIES ON PAGES 155

MORE GAS ACCESSORIES ON PAGES 158

<p>REMOTE CONTROL & WIRELESS RECEIVER OPT-RC110V</p>	<p>WEATHERPROOF ON/OFF SWITCH OPT-WPS110V</p>	<p>110V EMERGENCY STOP BUTTON OPT-ESTOP</p>	<p>110V 1-HOUR DIAL TIMER OPT-DTM</p>	<p>GAS TIMER & EMERGENCY STOP OPT-ESTOPTM</p>	<p>NATURAL GAS KIT OPT-NGKNG - 0-290K BTU OPT-NGKNGHC - 291K+ BTU</p>	<p>LIQUID PROPANE KIT OPT-LPKLP - 0-290K BTU OPT-LPKLPHC - 291K+ BTU</p>
--	---	---	---	---	---	--

Proudly Made In The USA



The Patented Bullet Burner's eliminate the need for an additional LP air mixer. Suitable for either natural gas or liquid propane applications. Electronic ignition systems require 10" clearance below the pan. 110V Ignition System Kits use a 3-prong grounded plug.

BURNER SIZE GUIDE: **M** = Double Inlet and uses manifold that adds 5" in height below the pan ; **2R** = 2 Rings ; **3R** = 3 Rings ; **4R** = 4 Rings



Round Flat Pan & SS Triple S Bullet Burner

ITEM	PAN & BURNER ONLY	FLAME SENSE MATCH LIT CERTIFIED	FLAME SENSE W/ SPARK IGNITION	ELECTRONIC 12V CSA CERTIFIED	ELECTRONIC 110V CSA CERTIFIED	BURNER SIZE	GAS INLET	BTU
18" Pan Kit - A	OPT-BFP18RSS	OPT-BFP18RSSFSML	OPT-BFP18RSSFSEN	OPT-BFP18RSSE12	OPT-BFP18RSSE110	8"	½"	50,000
18" Pan Kit - B	OPT-BFP182RSS	OPT-BFP182RSSFSML	OPT-BFP182RSSFSEN	OPT-BFP182RSSE12	OPT-BFP182RSSE110	12"	½"	75,000
24" Pan Kit	OPT-BFP24RSS	OPT-BFP24RSSFSML	OPT-BFP24RSSFSEN	OPT-BFP24RSSE12	OPT-BFP24RSSE110	18"	½"	110,000
30" Pan Kit	OPT-BFP30RSS	N/A	OPT-BFP30RSSFSEN	OPT-BFP30RSSE12	OPT-BFP30RSSE110	24"	¾"	145,000
36" Pan Kit	OPT-BFP36RSS	N/A	N/A	OPT-BFP36RSSE12	OPT-BFP36RSSE110	30"	¾"	180,000
48" Pan Kit	OPT-BFP48RSS	N/A	N/A	OPT-BFP48RSSE12	OPT-BFP48RSSE110	36"	¾"	220,000
60" Pan Kit	OPT-BFP60RSS	N/A	N/A	OPT-BFP60RSSE12	OPT-BFP60RSSE110	48"	¾"	385,000



Round Flat Pan & SS Round Bullet Burner

ITEM	PAN & BURNER ONLY	FLAME SENSE MATCH LIT CERTIFIED	FLAME SENSE W/ SPARK IGNITION	ELECTRONIC 12V CSA CERTIFIED	ELECTRONIC 110V CSA CERTIFIED	BURNER SIZE	GAS INLET	BTU
18" Pan Kit - A	OPT-BFP18RDSS	OPT-BFP18RDSSFSML	OPT-BFP18RDSSFSEN	OPT-BFP18RDSSE12	OPT-BFP18RDSSE110	8"	½"	65,000
18" Pan Kit - B	OPT-BFP182RDSS	OPT-BFP182RDSSFSML	OPT-BFP182RDSSFSEN	OPT-BFP182RDSSE12	OPT-BFP182RDSSE110	12"	½"	100,000
24" Pan Kit	OPT-BFP24RDSS	OPT-BFP24RDSSFSML	OPT-BFP24RDSSFSEN	OPT-BFP24RDSSE12	OPT-BFP24RDSSE110	18" (2R)	½"	225,000
30" Pan Kit	OPT-BFP30RDSS	N/A	OPT-BFP30RDSSFSEN	OPT-BFP30RDSSE12	OPT-BFP30RDSSE110	24" (2R)	¾"	275,000
36" Pan Kit	OPT-BFP36RDSS	N/A	N/A	OPT-BFP36RDSSE12	OPT-BFP36RDSSE110	30" (3R)	¾"	460,000
48" Pan Kit	OPT-BFP48RDSS	N/A	N/A	OPT-BFP48RDSSE12	OPT-BFP48RDSSE110	36" (3R)	¾"	525,000
60" Pan Kit	OPT-BFP60RDSS	N/A	N/A	OPT-BFP60RDSSE12	OPT-BFP60RDSSE110	48" (4R, M)	¾"	850,000

FLAT PAN SS BULLET BURNER KITS

PATENTED DESIGN

LIFETIME WARRANTY ON ALL BURNERS

The Patented Bullet Burner's eliminate the need for an additional LP air mixer. Suitable for either natural gas or liquid propane applications. Electronic ignition systems require 10" clearance below the pan. 110V Ignition System Kits use a 3-prong grounded plug.

BURNER SIZE GUIDE: M = Double Inlet and uses manifold that adds 5" in height below the pan ; 2R = 2 Rings ; 3R = 3 Rings ; 4R = 4 Rings

12V Ignition

110V Ignition

Flame Sense



Square Flat Pan & SS Triple S Bullet Burner

ITEM	PAN & BURNER ONLY	FLAME SENSE MATCH LIT CERTIFIED	FLAME SENSE W/ SPARK IGNITION	ELECTRONIC 12V CSA CERTIFIED	ELECTRONIC 110V CSA CERTIFIED	BURNER SIZE	GAS INLET	BTU
18" Pan Kit - A	OPT-BFP18SSS	OPT-BFP18SSSFMSL	OPT-BFP18SSSFSEN	OPT-BFP18SSSE12	OPT-BFP18SSSE110	8"	½"	50,000
18" Pan Kit - B	OPT-BFP182SSS	OPT-BFP182SSSFMSL	OPT-BFP182SSSFSEN	OPT-BFP182SSSE12	OPT-BFP182SSSE110	12"	½"	75,000
24" Pan Kit	OPT-BFP24SSS	OPT-BFP24SSSFMSL	OPT-BFP24SSSFSEN	OPT-BFP24SSSE12	OPT-BFP24SSSE110	18"	½"	110,000
30" Pan Kit	OPT-BFP30SSS	N/A	OPT-BFP30SSSFSEN	OPT-BFP30SSSE12	OPT-BFP30SSSE110	24"	¾"	145,000
36" Pan Kit	OPT-BFP36SSS	N/A	N/A	OPT-BFP36SSSE12	OPT-BFP36SSSE110	30"	¾"	180,000
48" Pan Kit	OPT-BFP48SSS	N/A	N/A	OPT-BFP48SSSE12	OPT-BFP48SSSE110	36"	¾"	220,000
60" Pan Kit	OPT-BFP60SSS	N/A	N/A	OPT-BFP60SSSE12	OPT-BFP60SSSE110	48"	¾"	385,000

12V Ignition

110V Ignition

Flame Sense



Square Flat Pan & SS Square Bullet Burner

ITEM	PAN & BURNER ONLY	FLAME SENSE MATCH LIT CERTIFIED	FLAME SENSE W/ SPARK IGNITION	ELECTRONIC 12V CSA CERTIFIED	ELECTRONIC 110V CSA CERTIFIED	BURNER SIZE	GAS INLET	BTU
18" Pan Kit - A	OPT-BFP18SQSS	OPT-BFP18SQSSFMSL	OPT-BFP18SQSSFSEN	OPT-BFP18SQSSE12	OPT-BFP18SQSSE110	8"	½"	80,000
18" Pan Kit - B	OPT-BFP182SQSS	OPT-BFP182SQSSFMSL	OPT-BFP182SQSSFSEN	OPT-BFP182SQSSE12	OPT-BFP182SQSSE110	12"	½"	120,000
24" Pan Kit	OPT-BFP24SQSS	OPT-BFP24SQSSFMSL	OPT-BFP24SQSSFSEN	OPT-BFP24SQSSE12	OPT-BFP24SQSSE110	18" (2R)	½"	280,000
30" Pan Kit	OPT-BFP30SQSS	N/A	OPT-BFP30SQSSFSEN	OPT-BFP30SQSSE12	OPT-BFP30SQSSE110	24" (2R)	¾"	340,000
36" Pan Kit	OPT-BFP36SQSS	N/A	N/A	OPT-BFP36SQSSE12	OPT-BFP36SQSSE110	30" (3R)	¾"	565,000
48" Pan Kit	OPT-BFP48SQSS	N/A	N/A	OPT-BFP48SQSSE12	OPT-BFP48SQSSE110	36" (3R)	¾"	650,000
60" Pan Kit	OPT-BFP60SQSS	N/A	N/A	OPT-BFP60SQSSE12	OPT-BFP60SQSSE110	48" (4R, M)	¾"	1,060,000

MORE ELECTRONIC IGNITION ACCESSORIES ON PAGES 155

MORE GAS ACCESSORIES ON PAGES 158

<p>REMOTE CONTROL & WIRELESS RECEIVER OPT-RC110V</p>	<p>WEATHERPROOF ON/OFF SWITCH OPT-WPS110V</p>	<p>110V EMERGENCY STOP BUTTON OPT-ESTOP</p>	<p>110V 1-HOUR DIAL TIMER OPT-DTM</p>	<p>GAS TIMER & EMERGENCY STOP OPT-ESTOPTM</p>	<p>NATURAL GAS KIT OPT-NGKNG - 0-290K BTU OPT-NGKNGHC - 291K+ BTU</p>	<p>LIQUID PROPANE KIT OPT-LPKLP - 0-290K BTU OPT-LPKLPHC - 291K+ BTU</p>
--	---	---	---	---	---	--

Proudly Made In The USA



The Patented Bullet Burner's eliminate the need for an additional LP air mixer. Suitable for either natural gas or liquid propane applications. Electronic ignition systems require 10" clearance below the pan. 110V Ignition System Kits use a 3-prong grounded plug.

BURNER SIZE GUIDE: M = Double Inlet and uses manifold that adds 5" in height below the pan ; 2R = 2 Rings ; 3R = 3 Rings ; 4R = 4 Rings

12V Ignition

110V Ignition

Flame Sense



Rectangular Flat Pan & SS Linear Bullet Burner

ITEM	PAN & BURNER ONLY	FLAME SENSE MATCH LIT CERTIFIED	FLAME SENSE W/ SPARK IGNITION	ELECTRONIC 12V CSA CERTIFIED	ELECTRONIC 110V CSA CERTIFIED	BURNER SIZE	GAS INLET	BTU
24"x8" Pan Kit	OPT-BFP24RTSS	OPT-BFP24RTSSFSML	OPT-BFP24RTSSFSFN	OPT-BFP24RTSSE12	OPT-BFP24RTSSE110	18"	½"	40,000
36"x8" Pan Kit	OPT-BFP36RTSS	OPT-BFP36RTSSFSML	OPT-BFP36RTSSFSFN	OPT-BFP36RTSSE12	OPT-BFP36RTSSE110	30"	½"	60,000
48"x8" Pan Kit	OPT-BFP48RTSS	OPT-BFP48RTSSFSML	OPT-BFP48RTSSFSFN	OPT-BFP48RTSSE12	OPT-BFP48RTSSE110	42"	½"	85,000
60"x8" Pan Kit	OPT-BFP60RTSS	OPT-BFP60RTSSFSML	OPT-BFP60RTSSFSFN	OPT-BFP60RTSSE12	OPT-BFP60RTSSE110	48"	¾"	110,000
72"x8" Pan Kit	OPT-BFP72RTSS	OPT-BFP72RTSSFSML	OPT-BFP72RTSSFSFN	OPT-BFP72RTSSE12	OPT-BFP72RTSSE110	60"	¾"	135,000
84"x8" Pan Kit	OPT-BFP84RTSS	N/A	N/A	OPT-BFP84RTSSE12	OPT-BFP84RTSSE110	72"	¾"	160,000
96"x8" Pan Kit	OPT-BFP96RTSS	N/A	N/A	OPT-BFP96RTSSE12	OPT-BFP96RTSSE110	84"	¾"	180,000

12V Ignition

110V Ignition

Flame Sense



Rectangular Flat Pan & SS 'H' Bullet Burner

ITEM	PAN & BURNER ONLY	FLAME SENSE MATCH LIT CERTIFIED	FLAME SENSE W/ SPARK IGNITION	ELECTRONIC 12V CSA CERTIFIED	ELECTRONIC 110V CSA CERTIFIED	BURNER SIZE	GAS INLET	BTU
24"x12" Pan Kit	OPT-BFP1224R5S	OPT-BFP1224R5SFSML	OPT-BFP1224R5SFSFN	OPT-BFP1224RSSE12	OPT-BFP1224RSSE110	18"x6"	½"	85,000
36"x12" Pan Kit	OPT-BFP1236R5S	OPT-BFP1236R5SFSML	OPT-BFP1236R5SFSFN	OPT-BFP1236RSSE12	OPT-BFP1236RSSE110	30"x6"	½"	110,000
48"x12" Pan Kit	OPT-BFP1248R5S	OPT-BFP1248R5SFSML	OPT-BFP1248R5SFSFN	OPT-BFP1248RSSE12	OPT-BFP1248RSSE110	42"x6"	¾"	160,000
60"x12" Pan Kit	OPT-BFP1260R5S	N/A	N/A	OPT-BFP1260RSSE12	OPT-BFP1260RSSE110	48"x6"	¾"	205,000
72"x12" Pan Kit	OPT-BFP1272R5S	N/A	N/A	OPT-BFP1272RSSE12	OPT-BFP1272RSSE110	60"x6" (M)	¾"	255,000
84"x12" Pan Kit	OPT-BFP1284R5S	N/A	N/A	OPT-BFP1284RSSE12	OPT-BFP1284RSSE110	72"x6" (M)	¾"	300,000
96"x12" Pan Kit	OPT-BFP1296R5S	N/A	N/A	OPT-BFP1296RSSE12	OPT-BFP1296RSSE110	84"x6" (M)	¾"	350,000

12V Ignition

110V Ignition

Flame Sense



Rectangular Flat Pan & SS Switchback Bullet Burner

ITEM	PAN & BURNER ONLY	FLAME SENSE MATCH LIT CERTIFIED	FLAME SENSE W/ SPARK IGNITION	ELECTRONIC 12V CSA CERTIFIED	ELECTRONIC 110V CSA CERTIFIED	BURNER SIZE	GAS INLET	BTU
24"x12" Pan Kit	OPT-BFP1224SB5S	OPT-BFP1224SB5SFSML	OPT-BFP1224SB5SFSFN	OPT-BFP1224SB5SSE12	OPT-BFP1224SB5SSE110	18"x6"	½"	70,000
36"x12" Pan Kit	OPT-BFP1236SB5S	OPT-BFP1236SB5SFSML	OPT-BFP1236SB5SFSFN	OPT-BFP1236SB5SSE12	OPT-BFP1236SB5SSE110	30"x6"	½"	90,000
48"x12" Pan Kit	OPT-BFP1248SB5S	OPT-BFP1248SB5SFSML	OPT-BFP1248SB5SFSFN	OPT-BFP1248SB5SSE12	OPT-BFP1248SB5SSE110	42"x6"	¾"	125,000
60"x12" Pan Kit	OPT-BFP1260SB5S	N/A	N/A	OPT-BFP1260SB5SSE12	OPT-BFP1260SB5SSE110	48"x6"	¾"	165,000
72"x12" Pan Kit	OPT-BFP1272SB5S	N/A	N/A	OPT-BFP1272SB5SSE12	OPT-BFP1272SB5SSE110	60"x6" (M)	¾"	200,000
84"x12" Pan Kit	OPT-BFP1284SB5S	N/A	N/A	OPT-BFP1284SB5SSE12	OPT-BFP1284SB5SSE110	72"x6" (M)	¾"	240,000
96"x12" Pan Kit	OPT-BFP1296SB5S	N/A	N/A	OPT-BFP1296SB5SSE12	OPT-BFP1296SB5SSE110	84"x6" (M)	¾"	360,000

DROP-IN PAN & SS BULLET BURNER KITS

PATENTED DESIGN

LIFETIME WARRANTY ON ALL BURNERS

Bullet Burner's eliminate the need for an additional LP air mixer. Suitable for either natural gas or liquid propane applications. Pans have 1" Lip & 2" Height. Electronic ignition requires 10" clearance below the pan. 110V Ignition System Kits use a 3-prong grounded plug.

BURNER SIZE GUIDE: **M** = Double Inlet and uses manifold that adds 5" in height below the pan ; **2R** = 2 Rings ; **3R** = 3 Rings ; **4R** = 4 Rings



Round Drop In & SS Triple S Bullet Burner

ITEM	PAN & BURNER ONLY	FLAME SENSE MATCH LIT CERTIFIED	FLAME SENSE W/ SPARK IGNITION	ELECTRONIC 12V CSA CERTIFIED	ELECTRONIC 110V CSA CERTIFIED	BURNER SIZE	GAS INLET	BTU
13" Pan Kit	OPT-BP13RDSS	OPT-BP13RDSSFML	OPT-BP13RDSSFSEN	OPT-BP13RDSSE12	OPT-BP13RDSSE110	8"	½"	50,000
19" Pan Kit	OPT-BP19RDSS	OPT-BP19RDSSFML	OPT-BP19RDSSFSEN	OPT-BP19RDSSE12	OPT-BP19RDSSE110	12"	½"	75,000
25" Pan Kit	OPT-BP25RDSS	OPT-BP25RDSSFML	OPT-BP25RDSSFSEN	OPT-BP25RDSSE12	OPT-BP25RDSSE110	18"	½"	110,000
31" Pan Kit	OPT-BP31RDSS	N/A	N/A	OPT-BP31RDSSE12	OPT-BP31RDSSE110	24"	¾"	145,000
37" Pan Kit	OPT-BP37RDSS	N/A	N/A	OPT-BP37RDSSE12	OPT-BP37RDSSE110	30"	¾"	180,000
43" Pan Kit	OPT-BP43RDSS	N/A	N/A	OPT-BP43RDSSE12	OPT-BP43RDSSE110	36"	¾"	220,000



Round Drop In & SS Round Bullet Burner

ITEM	PAN & BURNER ONLY	FLAME SENSE MATCH LIT CERTIFIED	FLAME SENSE W/ SPARK IGNITION	ELECTRONIC 12V CSA CERTIFIED	ELECTRONIC 110V CSA CERTIFIED	BURNER SIZE	GAS INLET	BTU
13" Pan Kit	OPT-BP13RRSS	OPT-BP13RRSSFML	OPT-BP13RRSSFSEN	OPT-BP13RRSSE12	OPT-BP13RRSSE110	8"	½"	65,000
19" Pan Kit	OPT-BP19RRSS	OPT-BP19RRSSFML	OPT-BP19RRSSFSEN	OPT-BP19RRSSE12	OPT-BP19RRSSE110	12"	½"	100,000
25" Pan Kit	OPT-BP25RRSS	OPT-BP25RRSSFML	OPT-BP25RRSSFSEN	OPT-BP25RRSSE12	OPT-BP25RRSSE110	18" (2R)	½"	225,000
31" Pan Kit	OPT-BP31RRSS	N/A	N/A	OPT-BP31RRSSE12	OPT-BP31RRSSE110	24" (2R)	¾"	275,000
37" Pan Kit	OPT-BP37RRSS	N/A	N/A	OPT-BP37RRSSE12	OPT-BP37RRSSE110	30" (3R)	¾"	460,000
43" Pan Kit	OPT-BP43RRSS	N/A	N/A	OPT-BP43RRSSE12	OPT-BP43RRSSE110	36" (3R)	¾"	525,000

Proudly Made In The USA



Bullet Burner's eliminate the need for an additional LP air mixer. Suitable for either natural gas or liquid propane applications. Pans have 1" Lip & 2" Height. Electronic ignition requires 10" clearance below the pan. 110V Ignition System Kits use a 3-prong grounded plug.

BURNER SIZE GUIDE: **M** = Double Inlet and uses manifold that adds 5" in height below the pan ; **2R** = 2 Rings ; **3R** = 3 Rings ; **4R** = 4 Rings



Square Drop In & SS Triple S Bullet Burner

ITEM	PAN & BURNER ONLY	FLAME SENSE MATCH LIT CERTIFIED	FLAME SENSE W/ SPARK IGNITION	ELECTRONIC 12V CSA CERTIFIED	ELECTRONIC 110V CSA CERTIFIED	BURNER SIZE	GAS INLET	BTU
12" Pan Kit	OPT-BP12SDSS	OPT-BP12SDSSFSML	OPT-BP12SDSSFSEN	OPT-BP12SDSSE12	OPT-BP12SDSSE110	8"	½"	50,000
18" Pan Kit	OPT-BP18SDSS	OPT-BP18SDSSFSML	OPT-BP18SDSSFSEN	OPT-BP18SDSSE12	OPT-BP18SDSSE110	12"	½"	75,000
24" Pan Kit	OPT-BP24SDSS	OPT-BP24SDSSFSML	OPT-BP24SDSSFSEN	OPT-BP24SDSSE12	OPT-BP24SDSSE110	18"	½"	110,000
30" Pan Kit	OPT-BP30SDSS	N/A	OPT-BP30SDSSFSEN	OPT-BP30SDSSE12	OPT-BP30SDSSE110	24"	¾"	145,000
36" Pan Kit	OPT-BP36SDSS	N/A	N/A	OPT-BP36SDSSE12	OPT-BP36SDSSE110	30"	¾"	180,000
48" Pan Kit	OPT-BP48SDSS	N/A	N/A	OPT-BP48SDSSE12	OPT-BP48SDSSE110	36"	¾"	220,000



Square Drop In & SS Square Bullet Burner

ITEM	PAN & BURNER ONLY	FLAME SENSE MATCH LIT CERTIFIED	FLAME SENSE W/ SPARK IGNITION	ELECTRONIC 12V CSA CERTIFIED	ELECTRONIC 110V CSA CERTIFIED	BURNER SIZE	GAS INLET	BTU
12" Pan Kit	OPT-BP12SQDSS	OPT-BP12SQDSSFSML	OPT-BP12SQDSSFSEN	OPT-BP12SQDSSE12	OPT-BP12SQDSSE110	8"	½"	65,000
18" Pan Kit	OPT-BP18SQDSS	OPT-BP18SQDSSFSML	OPT-BP18SQDSSFSEN	OPT-BP18SQDSSE12	OPT-BP18SQDSSE110	12"	½"	100,000
24" Pan Kit	OPT-BP24SQDSS	OPT-BP24SQDSSFSML	OPT-BP24SQDSSFSEN	OPT-BP24SQDSSE12	OPT-BP24SQDSSE110	18" (2R)	½"	225,000
30" Pan Kit	OPT-BP30SQDSS	N/A	OPT-BP30SQDSSFSEN	OPT-BP30SQDSSE12	OPT-BP30SQDSSE110	24" (2R)	¾"	275,000
36" Pan Kit	OPT-BP36SQDSS	N/A	N/A	OPT-BP36SQDSSE12	OPT-BP36SQDSSE110	30" (3R)	¾"	460,000
48" Pan Kit	OPT-BP48SQDSS	N/A	N/A	OPT-BP48SQDSSE12	OPT-BP48SQDSSE110	36" (3R)	¾"	525,000

DROP-IN PAN BRASS BULLET BURNER KITS

PATENTED DESIGN

LIFETIME WARRANTY ON ALL BURNERS

Bullet Burner's eliminate the need for an additional LP air mixer. Suitable for either natural gas or liquid propane applications. Pans have 1" Lip & 2" Height. Electronic ignition requires 10" clearance below the pan. 110V Ignition System Kits use a 3-prong grounded plug.

BURNER SIZE GUIDE: M = Double Inlet and uses manifold that adds 5" in height below the pan ; 2R = 2 Rings ; 3R = 3 Rings ; 4R = 4 Rings



Rectangular Drop In & SS Linear Bullet Burner

ITEM	PAN & BURNER ONLY	FLAME SENSE MATCH LIT CERTIFIED	FLAME SENSE W/ SPARK IGNITION	ELECTRONIC 12V CSA CERTIFIED	ELECTRONIC 110V CSA CERTIFIED	BURNER SIZE	GAS INLET	BTU
24"x8" Pan Kit	OPT-BP824RDSS	OPT-BP824RDSSFSML	OPT-BP824RDSSFSSEN	OPT-BP824RDSSE12	OPT-BP824RDSSE110	18"	½"	40,000
36"x8" Pan Kit	OPT-BP836RDSS	OPT-BP836RDSSFSML	OPT-BP836RDSSFSSEN	OPT-BP836RDSSE12	OPT-BP836RDSSE110	30"	½"	50,000
48"x8" Pan Kit	OPT-BP848RDSS	OPT-BP848RDSSFSML	OPT-BP848RDSSFSSEN	OPT-BP848RDSSE12	OPT-BP848RDSSE110	42"	½"	75,000
60"x8" Pan Kit	OPT-BP860RDSS	OPT-BP860RDSSFSML	OPT-BP860RDSSFSSEN	OPT-BP860RDSSE12	OPT-BP860RDSSE110	48"	½"	100,000
72"x8" Pan Kit	OPT-BP872RDSS	OPT-BP872RDSSFSML	OPT-BP872RDSSFSSEN	OPT-BP872RDSSE12	OPT-BP872RDSSE110	60"	¾"	120,000
84"x8" Pan Kit	OPT-BP884RDSS	N/A	N/A	OPT-BP884RDSSE12	OPT-BP884RDSSE110	72"	¾"	145,000
96"x8" Pan Kit	OPT-BP896RDSS	N/A	N/A	OPT-BP896RDSSE12	OPT-BP896RDSSE110	84"	¾"	170,000



Rectangular Drop In & SS 'H' Bullet Burner

ITEM	PAN & BURNER ONLY	FLAME SENSE MATCH LIT CERTIFIED	FLAME SENSE W/ SPARK IGNITION	ELECTRONIC 12V CSA CERTIFIED	ELECTRONIC 110V CSA CERTIFIED	BURNER SIZE	GAS INLET	BTU
24"x12" Pan Kit	OPT-BP1224RDSS	OPT-BP1224RDSSFSML	OPT-BP1224RDSSFSSEN	OPT-BP1224RDSSE12	OPT-BP1224RDSSE110	18"x6"	½"	85,000
36"x12" Pan Kit	OPT-BP1236RDSS	OPT-BP1236RDSSFSML	OPT-BP1236RDSSFSSEN	OPT-BP1236RDSSE12	OPT-BP1236RDSSE110	24"x6"	½"	110,000
48"x12" Pan Kit	OPT-BP1248RDSS	OPT-BP1248RDSSFSML	OPT-BP1248RDSSFSSEN	OPT-BP1248RDSSE12	OPT-BP1248RDSSE110	42"x6"	¾"	160,000
60"x12" Pan Kit	OPT-BP1260RDSS	N/A	N/A	OPT-BP1260RDSSE12	OPT-BP1260RDSSE110	48"x6"	¾"	205,000
72"x12" Pan Kit	OPT-BP1272RDSS	N/A	N/A	OPT-BP1272RDSSE12	OPT-BP1272RDSSE110	60"x6" (M)	¾"	255,000
84"x12" Pan Kit	OPT-BP1284RDSS	N/A	N/A	OPT-BP1284RDSSE12	OPT-BP1284RDSSE110	72"x6" (M)	¾"	300,000
96"x12" Pan Kit	OPT-BP1296RDSS	N/A	N/A	OPT-BP1296RDSSE12	OPT-BP1296RDSSE110	84"x6" (M)	¾"	350,000

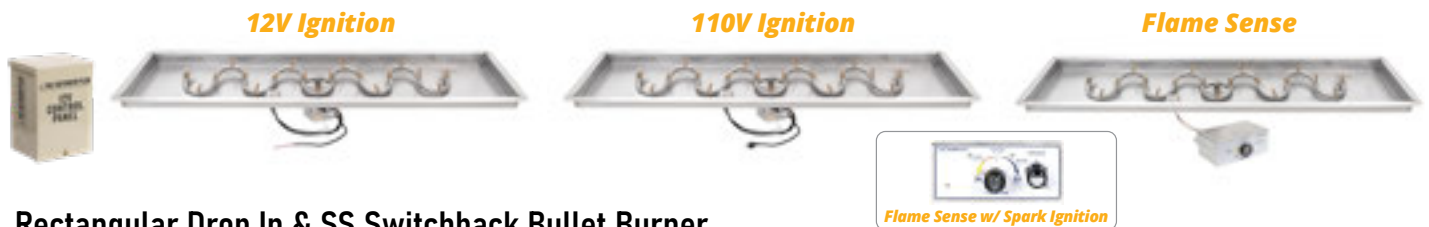

Rectangular Drop In & SS Switchback Bullet Burner

ITEM	PAN & BURNER ONLY	FLAME SENSE MATCH LIT CERTIFIED	FLAME SENSE W/ SPARK IGNITION	ELECTRONIC 12V CSA CERTIFIED	ELECTRONIC 110V CSA CERTIFIED	BURNER SIZE	GAS INLET	BTU
24"x12" Pan Kit	OPT-BP1224SBDSS	OPT-BP1224SBDSSFSML	OPT-BP1224SBDSSFSSEN	OPT-BP1224SBDSSSE12	OPT-BP1224SBDSSSE110	18"x6"	½"	70,000
36"x12" Pan Kit	OPT-BP1236SBDSS	OPT-BP1236SBDSSFSML	OPT-BP1236SBDSSFSSEN	OPT-BP1236SBDSSSE12	OPT-BP1236SBDSSSE110	30"x6"	½"	90,000
48"x12" Pan Kit	OPT-BP1248SBDSS	OPT-BP1248SBDSSFSML	OPT-BP1248SBDSSFSSEN	OPT-BP1248SBDSSSE12	OPT-BP1248SBDSSSE110	42"x6"	¾"	125,000
60"x12" Pan Kit	OPT-BP1260SBDSS	N/A	N/A	OPT-BP1260SBDSSSE12	OPT-BP1260SBDSSSE110	48"x6"	¾"	165,000
72"x12" Pan Kit	OPT-BP1272SBDSS	N/A	N/A	OPT-BP1272SBDSSSE12	OPT-BP1272SBDSSSE110	60"x6" (M)	¾"	200,000
84"x12" Pan Kit	OPT-BP1284SBDSS	N/A	N/A	OPT-BP1284SBDSSSE12	OPT-BP1284SBDSSSE110	72"x6" (M)	¾"	240,000
96"x12" Pan Kit	OPT-BP1296SBDSS	N/A	N/A	OPT-BP1296SBDSSSE12	OPT-BP1296SBDSSSE110	84"x6" (M)	¾"	360,000

Suitable for either natural gas or liquid propane applications. Electronic ignition systems require 10" clearance below the pan. 110V Ignition System Kits use a 3-prong grounded plug.

BURNER SIZE GUIDE: **M** = Double Inlet and uses manifold that adds 5" in height below the pan ; **2R** = 2 Rings ; **3R** = 3 Rings ; **4R** = 4 Rings



Round Flat Pan & Round SS Burner

ITEM	PAN & BURNER ONLY	FLAME SENSE MATCH LIT CERTIFIED	FLAME SENSE W/ SPARK IGNITION	ELECTRONIC 12V CSA CERTIFIED	ELECTRONIC 110V CSA CERTIFIED	BURNER SIZE	GAS INLET	BTU
12" Pan Kit	OPT-110012BP	OPT-110012BPFMSML	OPT-110012BPFSEN	OPT-110012BPE12	OPT-110012BPE110	6"	½"	35,000
18" Pan Kit	OPT-110018BP	OPT-110018BPFMSML	OPT-110018BPFSEN	OPT-110018BPE12	OPT-110018BPE110	12"	½"	65,000
24" Pan Kit	OPT-110024BP	OPT-110024BPFMSML	OPT-110024BPFSEN	OPT-110024BPE12	OPT-110024BPE110	18" (2R)	½"	160,000
30" Pan Kit	OPT-110030BP	N/A	OPT-110030BPFSEN	OPT-110030BPE12	OPT-110030BPE110	24" (2R)	½"	190,000
36" Pan Kit	OPT-110036BP	N/A	N/A	OPT-110036BPE12	OPT-110036BPE110	30" (3R)	¾"	330,000
42" Pan Kit	OPT-110042BP	N/A	N/A	OPT-110042BPE12	OPT-110042BPE110	36" (3R)	¾"	380,000
48" Pan Kit	OPT-110048BP	N/A	N/A	OPT-110048BPE12	OPT-110048BPE110	36" (3R)	¾"	380,000



Round Flat Pan & SS Lotus Burner

ITEM	PAN & BURNER ONLY	FLAME SENSE MATCH LIT CERTIFIED	FLAME SENSE W/ SPARK IGNITION	ELECTRONIC 12V CSA CERTIFIED	ELECTRONIC 110V CSA CERTIFIED	BURNER SIZE	GAS INLET	BTU
18" Pan Kit	OPT-FRLB18	OPT-FRLB18FSML	OPT-FRLB18FSEN	OPT-FRLB18E12	OPT-FRLB18E110	12"	½"	60,000
24" Pan Kit	OPT-FRLB24	OPT-FRLB24FSML	OPT-FRLB24FSEN	OPT-FRLB24E12	OPT-FRLB24E110	18"	½"	120,000
30" Pan Kit	OPT-FRLB30	N/A	OPT-FRLB30FSEN	OPT-FRLB30E12	OPT-FRLB30E110	24"	½"	190,000
36" Pan Kit	OPT-FRLB36	N/A	N/A	OPT-FRLB36E12	OPT-FRLB36E110	30"	¾"	260,000
42" Pan Kit	OPT-FRLB42	N/A	N/A	OPT-FRLB42E12	OPT-FRLB42E110	36"	¾"	340,000
48" Pan Kit	OPT-FRLB48	N/A	N/A	OPT-FRLB48E12	OPT-FRLB48E110	36"	¾"	340,000

Suitable for either natural gas or liquid propane applications. Electronic ignition systems require 10" clearance below the pan. 110V Ignition System Kits use a 3-prong grounded plug.

BURNER SIZE GUIDE: **M** = Double Inlet and uses manifold that adds 5" in height below the pan ; **2R** = 2 Rings ; **3R** = 3 Rings ; **4R** = 4 Rings



Square Flat Pan & Square SS Burner

ITEM	PAN & BURNER ONLY	FLAME SENSE MATCH LIT CERTIFIED	FLAME SENSE W/ SPARK IGNITION	ELECTRONIC 12V CSA CERTIFIED	ELECTRONIC 110V CSA CERTIFIED	BURNER SIZE	GAS INLET	BTU
16.5" Pan Kit	OPT-999BP16	OPT-999BP16FSML	OPT-999BP16FSEN	OPT-999BP16E12	OPT-999BP16E110	12"	½"	65,000
18" Pan Kit	OPT-999BP18	OPT-999BP18FSML	OPT-999BP18FSEN	OPT-999BP18E12	OPT-999BP18E110	12"	½"	90,000
24" Pan Kit	OPT-999BP24	OPT-999BP24FSML	OPT-999BP24FSEN	OPT-999BP24E12	OPT-999BP24E110	18" (2R)	½"	160,000
30" Pan Kit	OPT-999BP30	N/A	OPT-999BP30FSEN	OPT-999BP30E12	OPT-999BP30E110	24" (2R)	½"	190,000
36" Pan Kit	OPT-999BP36	N/A	N/A	OPT-999BP36E12	OPT-999BP36E110	30" (3R)	¾"	310,000
48" Pan Kit	OPT-999BP48	N/A	N/A	OPT-999BP48E12	OPT-999BP48E110	36" (3R)	¾"	375,000



Square Flat Pan & SS Lotus Burner

ITEM	PAN & BURNER ONLY	FLAME SENSE MATCH LIT CERTIFIED	FLAME SENSE W/ SPARK IGNITION	ELECTRONIC 12V CSA CERTIFIED	ELECTRONIC 110V CSA CERTIFIED	BURNER SIZE	GAS INLET	BTU
16.5" Pan Kit	OPT-FSLB16	OPT-FSLB16FSML	OPT-FSLB16FSEN	OPT-FSLB16E12	OPT-FSLB16E110	12"	½"	90,000
18" Pan Kit	OPT-FSLB18	OPT-FSLB18FSML	OPT-FSLB18FSEN	OPT-FSLB18E12	OPT-FSLB18E110	12"	½"	90,000
24" Pan Kit	OPT-FSLB24	OPT-FSLB24FSML	OPT-FSLB24FSEN	OPT-FSLB24E12	OPT-FSLB24E110	18"	½"	115,000
30" Pan Kit	OPT-FSLB30	N/A	OPT-FSLB30FSEN	OPT-FSLB30E12	OPT-FSLB30E110	24"	½"	175,000
36" Pan Kit	OPT-FSLB36	N/A	N/A	OPT-FSLB36E12	OPT-FSLB36E110	30"	¾"	220,000
48" Pan Kit	OPT-FSLB48	N/A	N/A	OPT-FSLB48E12	OPT-FSLB48E110	36"	¾"	265,000



Suitable for either natural gas or liquid propane applications. Electronic ignition systems require 10" clearance below the pan.
110V Ignition System Kits use a 3-prong grounded plug.

BURNER SIZE GUIDE: **M** = Double Inlet and uses manifold that adds 5" in height below the pan ; **2R** = 2 Rings ; **3R** = 3 Rings ; **4R** = 4 Rings



Rectangular Flat Pan & SS Linear Burner

ITEM	PAN & BURNER ONLY	FLAME SENSE MATCH LIT CERTIFIED	FLAME SENSE IGNITION	ELECTRONIC 12V CSA CERTIFIED	ELECTRONIC 110V CSA CERTIFIED	BURNER SIZE	GAS INLET	BTU
24" x 6" Pan Kit	OPT-REFS624	OPT-REFS624FSML	OPT-REFS624FSEN	OPT-REFS624E12	OPT-REFS624E110	18"	½"	30,000
30" x 6" Pan Kit	OPT-REFS630	OPT-REFS630FSML	OPT-REFS630FSEN	OPT-REFS630E12	OPT-REFS630E110	24"	½"	40,000
36" x 6" Pan Kit	OPT-REFS636	OPT-REFS636FSML	OPT-REFS636FSEN	OPT-REFS636E12	OPT-REFS636E110	30"	½"	50,000
42" x 6" Pan Kit	OPT-REFS642	OPT-REFS642FSML	OPT-REFS642FSEN	OPT-REFS642E12	OPT-REFS642E110	36"	½"	60,000
48" x 6" Pan Kit	OPT-REFS648	OPT-REFS648FSML	OPT-REFS648FSEN	OPT-REFS648E12	OPT-REFS648E110	42"	½"	70,000
60" x 6" Pan Kit	OPT-REFS660	OPT-REFS660FSML	OPT-REFS660FSEN	OPT-REFS660E12	OPT-REFS660E110	48"	½"	80,000
72" x 6" Pan Kit	OPT-REFS672	OPT-REFS672FSML	OPT-REFS672FSEN	OPT-REFS672E12	OPT-REFS672E110	60"	½"	100,000
84" x 6" Pan Kit	OPT-REFS684	N/A	N/A	OPT-REFS684E12	OPT-REFS684E110	72"	¼"	120,000
96" x 6" Pan Kit	OPT-REFS696	N/A	N/A	OPT-REFS696E12	OPT-REFS696E110	84"	¾"	140,000
24" x 8" Pan Kit	OPT-REFS824	OPT-REFS824FSML	OPT-REFS824FSEN	OPT-REFS824E12	OPT-REFS824E110	18"	½"	30,000
30" x 8" Pan Kit	OPT-REFS830	OPT-REFS830FSML	OPT-REFS830FSEN	OPT-REFS830E12	OPT-REFS830E110	24"	½"	40,000
36" x 8" Pan Kit	OPT-REFS836	OPT-REFS836FSML	OPT-REFS836FSEN	OPT-REFS836E12	OPT-REFS836E110	30"	½"	50,000
42" x 8" Pan Kit	OPT-REFS842	OPT-REFS842FSML	OPT-REFS842FSEN	OPT-REFS842E12	OPT-REFS842E110	36"	½"	60,000
48" x 8" Pan Kit	OPT-REFS848	OPT-REFS848FSML	OPT-REFS848FSEN	OPT-REFS848E12	OPT-REFS848E110	42"	½"	70,000
60" x 8" Pan Kit	OPT-REFS860	OPT-REFS860FSML	OPT-REFS860FSEN	OPT-REFS860E12	OPT-REFS860E110	48"	½"	80,000
72" x 8" Pan Kit	OPT-REFS872	OPT-REFS872FSML	OPT-REFS872FSEN	OPT-REFS872E12	OPT-REFS872E110	60"	½"	100,000
84" x 8" Pan Kit	OPT-REFS884	N/A	N/A	OPT-REFS884E12	OPT-REFS884E110	72"	½"	120,000
96" x 8" Pan Kit	OPT-REFS896	N/A	N/A	OPT-REFS896E12	OPT-REFS896E110	84"	¾"	140,000



Rectangular Flat Pan & SS 'H' Burner

ITEM	PAN & BURNER ONLY	FLAME SENSE MATCH LIT CERTIFIED	FLAME SENSE IGNITION	ELECTRONIC 12V CSA CERTIFIED	ELECTRONIC 110V CSA CERTIFIED	BURNER SIZE	GAS INLET	BTU
24" x 12" Pan Kit	OPT-REFD1224	OPT-REFD1224FSML	OPT-REFD1224FSEN	OPT-REFD1224E12	OPT-REFD1224E110	18" x 6"	½"	70,000
30" x 12" Pan Kit	OPT-REFD1230	OPT-REFD1230FSML	OPT-REFD1230FSEN	OPT-REFD1230E12	OPT-REFD1230E110	24" x 6"	½"	90,000
36" x 12" Pan Kit	OPT-REFD1236	OPT-REFD1236FSML	OPT-REFD1236FSEN	OPT-REFD1236E12	OPT-REFD1236E110	30" x 6"	½"	110,000
42" x 12" Pan Kit	OPT-REFD1242	OPT-REFD1242FSML	OPT-REFD1242FSEN	OPT-REFD1242E12	OPT-REFD1242E110	36" x 6"	½"	130,000
48" x 12" Pan Kit	OPT-REFD1248	N/A	N/A	OPT-REFD1248E12	OPT-REFD1248E110	42" x 6"	½"	150,000
60" x 12" Pan Kit	OPT-REFD1260	N/A	N/A	OPT-REFD1260E12	OPT-REFD1260E110	48" x 6"	½"	170,000
72" x 12" Pan Kit	OPT-REFD1272	N/A	N/A	OPT-REFD1272E12	OPT-REFD1272E110	60" x 6" (M)	¾"	210,000
84" x 12" Pan Kit	OPT-REFD1284	N/A	N/A	OPT-REFD1284E12	OPT-REFD1284E110	72" x 6" (M)	¾"	250,000
96" x 12" Pan Kit	OPT-REFD1296	N/A	N/A	OPT-REFD1296E12	OPT-REFD1296E110	84" x 6" (M)	¾"	290,000
24" x 18" Pan Kit	OPT-REFD1824	OPT-REFD1824FSML	OPT-REFD1824FSEN	OPT-REFD1824E12	OPT-REFD1824E110	18" x 12"	½"	70,000
30" x 18" Pan Kit	OPT-REFD1830	OPT-REFD1830FSML	OPT-REFD1830FSEN	OPT-REFD1830E12	OPT-REFD1830E110	24" x 12"	½"	90,000
36" x 18" Pan Kit	OPT-REFD1836	OPT-REFD1836FSML	OPT-REFD1836FSEN	OPT-REFD1836E12	OPT-REFD1836E110	30" x 12"	½"	110,000
42" x 18" Pan Kit	OPT-REFD1842	OPT-REFD1842FSML	OPT-REFD1842FSEN	OPT-REFD1842E12	OPT-REFD1842E110	36" x 12"	½"	130,000
48" x 18" Pan Kit	OPT-REFD1848	N/A	N/A	OPT-REFD1848E12	OPT-REFD1848E110	42" x 12"	½"	150,000
60" x 18" Pan Kit	OPT-REFD1860	N/A	N/A	OPT-REFD1860E12	OPT-REFD1860E110	48" x 12"	½"	170,000
72" x 18" Pan Kit	OPT-REFD1872	N/A	N/A	OPT-REFD1872E12	OPT-REFD1872E110	60" x 12" (M)	¾"	210,000
84" x 18" Pan Kit	OPT-REFD1884	N/A	N/A	OPT-REFD1884E12	OPT-REFD1884E110	72" x 12" (M)	¾"	250,000
96" x 18" Pan Kit	OPT-REFD1896	N/A	N/A	OPT-REFD1896E12	OPT-REFD1896E110	84" x 12" (M)	¾"	290,000

FLAT PAN & SS BURNER KITS

LIFETIME WARRANTY ON ALL BURNERS

Suitable for either natural gas or liquid propane applications. Electronic ignition systems require 10" clearance below the pan. 110V Ignition System Kits use a 3-prong grounded plug.

BURNER SIZE GUIDE: **M** = Double Inlet and uses manifold that adds 5" in height below the pan ; **2R** = 2 Rings ; **3R** = 3 Rings ; **4R** = 4 Rings



Rectangular Flat Pan & SS Switchback Burner

ITEM	PAN & BURNER ONLY	FLAME SENSE MATCH LIT CERTIFIED	FLAME SENSE W/ SPARK IGNITION	ELECTRONIC 12V CSA CERTIFIED	ELECTRONIC 110V CSA CERTIFIED	BURNER SIZE	GAS INLET	BTU
24" x 12" Pan Kit	OPT-RFSB1224	OPT-RFSB1224FSML	OPT-RFSB1224FSEN	OPT-RFSB1224E12	OPT-RFSB1224E110	18" x 6"	½"	60,000
30" x 12" Pan Kit	OPT-RFSB1230	OPT-RFSB1230FSML	OPT-RFSB1230FSEN	OPT-RFSB1230E12	OPT-RFSB1230E110	24" x 6"	½"	75,000
36" x 12" Pan Kit	OPT-RFSB1236	OPT-RFSB1236FSML	OPT-RFSB1236FSEN	OPT-RFSB1236E12	OPT-RFSB1236E110	30" x 6"	½"	90,000
42" x 12" Pan Kit	OPT-RFSB1242	N/A	N/A	OPT-RFSB1242E12	OPT-RFSB1242E110	36" x 6"	½"	105,000
48" x 12" Pan Kit	OPT-RFSB1248	N/A	N/A	OPT-RFSB1248E12	OPT-RFSB1248E110	42" x 6"	½"	125,000
60" x 12" Pan Kit	OPT-RFSB1260	N/A	N/A	OPT-RFSB1260E12	OPT-RFSB1260E110	48" x 6"	½"	140,000
72" x 12" Pan Kit	OPT-RFSB1272	N/A	N/A	OPT-RFSB1272E12	OPT-RFSB1272E110	60" x 6" (M)	¾"	170,000
84" x 12" Pan Kit	OPT-RFSB1284	N/A	N/A	OPT-RFSB1284E12	OPT-RFSB1284E110	72" x 6" (M)	¾"	200,000
96" x 12" Pan Kit	OPT-RFSB1296	N/A	N/A	OPT-RFSB1296E12	OPT-RFSB1296E110	84" x 6" (M)	¾"	305,000
24" x 18" Pan Kit	OPT-RFSB1824	OPT-RFSB1824FSML	OPT-RFSB1824FSEN	OPT-RFSB1824E12	OPT-RFSB1824E110	18" x 12"	½"	60,000
30" x 18" Pan Kit	OPT-RFSB1830	OPT-RFSB1830FSML	OPT-RFSB1830FSEN	OPT-RFSB1830E12	OPT-RFSB1830E110	24" x 12"	½"	75,000
36" x 18" Pan Kit	OPT-RFSB1836	OPT-RFSB1836FSML	OPT-RFSB1836FSEN	OPT-RFSB1836E12	OPT-RFSB1836E110	30" x 12"	½"	90,000
42" x 18" Pan Kit	OPT-RFSB1842	OPT-RFSB1842FSML	OPT-RFSB1842FSEN	OPT-RFSB1842E12	OPT-RFSB1842E110	36" x 12"	½"	105,000
48" x 18" Pan Kit	OPT-RFSB1848	N/A	N/A	OPT-RFSB1848E12	OPT-RFSB1848E110	42" x 12"	½"	125,000
60" x 18" Pan Kit	OPT-RFSB1860	N/A	N/A	OPT-RFSB1860E12	OPT-RFSB1860E110	48" x 12"	½"	140,000
72" x 18" Pan Kit	OPT-RFSB1872	N/A	N/A	OPT-RFSB1872E12	OPT-RFSB1872E110	60" x 12" (M)	¾"	170,000
84" x 18" Pan Kit	OPT-RFSB1884	N/A	N/A	OPT-RFSB1884E12	OPT-RFSB1884E110	72" x 12" (M)	¾"	200,000
96" x 18" Pan Kit	OPT-RFSB1896	N/A	N/A	OPT-RFSB1896E12	OPT-RFSB1896E110	84" x 12" (M)	¾"	305,000



Custom Oversized Linear Pan and Burner
Courtesy of Steele's Signature Pools, LLC, Medford, NJ, Sea Girt, NJ



Suitable for either natural gas or liquid propane applications. Pans have 1" Lip & 2" Height. Electronic ignition systems require 10" clearance below the pan. 110V Ignition System Kits use a 3-prong grounded plug.

BURNER SIZE GUIDE: **M** = Double Inlet and uses manifold that adds 5" in height below the pan ; **2R** = 2 Rings ; **3R** = 3 Rings ; **4R** = 4 Rings



Round Drop In Pan & Round SS Burner

ITEM	PAN & BURNER ONLY	FLAME SENSE MATCH LIT CERTIFIED	FLAME SENSE W/ SPARK IGNITION	ELECTRONIC 12V CSA CERTIFIED	ELECTRONIC 110V CSA CERTIFIED	BURNER SIZE	GAS INLET	BTU
13" Drop In Kit	OPT-PBR13	OPT-PBR13FSML	OPT-PBR13FSEN	OPT-PBR13E12	OPT-PBR13E110	6"	½"	65,000
19" Drop In Kit	OPT-PBR19	OPT-PBR19FSML	OPT-PBR19FSEN	OPT-PBR19E12	OPT-PBR19E110	12"	½"	90,000
25" Drop In Kit	OPT-PBR25	OPT-PBR25FSML	OPT-PBR25FSEN	OPT-PBR25E12	OPT-PBR25E110	18" (2R)	½"	160,000
31" Drop In Kit	OPT-PBR31	N/A	OPT-PBR31FSEN	OPT-PBR31E12	OPT-PBR31E110	24" (2R)	½"	190,000
37" Drop In Kit	OPT-PBR37	N/A	N/A	OPT-PBR37E12	OPT-PBR37E110	30" (3R)	¾"	310,000
43" Drop In Kit	OPT-PBR43	N/A	N/A	OPT-PBR43E12	OPT-PBR43E110	36" (3R)	¾"	375,000



Round Drop In Pan & SS Lotus Burner

ITEM	PAN & BURNER ONLY	FLAME SENSE MATCH LIT CERTIFIED	FLAME SENSE W/ SPARK IGNITION	ELECTRONIC 12V CSA CERTIFIED	ELECTRONIC 110V CSA CERTIFIED	BURNER SIZE	GAS INLET	BTU
19" Drop In Kit	OPT-PBRLF19	OPT-PBRLF19FSML	OPT-PBRLF19FSEN	OPT-PBRLF19E12	OPT-PBRLF19E110	12"	½"	90,000
25" Drop In Kit	OPT-PBRLF25	OPT-PBRLF25FSML	OPT-PBRLF25FSEN	OPT-PBRLF25E12	OPT-PBRLF25E110	18"	½"	115,000
31" Drop In Kit	OPT-PBRLF31	N/A	OPT-PBRLF31FSEN	OPT-PBRLF31E12	OPT-PBRLF31E110	24"	½"	175,000
37" Drop In Kit	OPT-PBRLF37	N/A	N/A	OPT-PBRLF37E12	OPT-PBRLF37E110	30"	¾"	220,000
43" Drop In Kit	OPT-PBRLF43	N/A	N/A	OPT-PBRLF43E12	OPT-PBRLF43E110	36"	¾"	265,000

DROP IN PAN & SS BURNER KITS

LIFETIME WARRANTY ON ALL BURNERS

Suitable for either natural gas or liquid propane applications. Pans have 1" Lip & 2" Height. Electronic ignition systems require 10" clearance below the pan. 110V Ignition System Kits use a 3-prong grounded plug.

BURNER SIZE GUIDE: **M** = Double Inlet and uses manifold that adds 5" in height below the pan ; **2R** = 2 Rings ; **3R** = 3 Rings ; **4R** = 4 Rings



Square Drop In Pan & Square SS Burner

ITEM	PAN & BURNER ONLY	FLAME SENSE MATCH LIT CERTIFIED	FLAME SENSE W/ SPARK IGNITION	ELECTRONIC 12V CSA CERTIFIED	ELECTRONIC 110V CSA CERTIFIED	BURNER SIZE	GAS INLET	BTU
16.5" Drop In Kit	OPT-PBS16	OPT-PBS16FSML	OPT-PBS16FSEN	OPT-PBS16E12	OPT-PBS16E110	12"	½"	90,000
18" Drop In Kit	OPT-PBS18	OPT-PBS18FSML	OPT-PBS18FSEN	OPT-PBS18E12	OPT-PBS18E110	12"	½"	90,000
24" Drop In Kit	OPT-PBS24	OPT-PBS24FSML	OPT-PBS24FSEN	OPT-PBS24E12	OPT-PBS24E110	18" (2R)	½"	160,000
30" Drop In Kit	OPT-PBS30	N/A	OPT-PBS30FSEN	OPT-PBS30E12	OPT-PBS30E110	24" (2R)	½"	190,000
36" Drop In Kit	OPT-PBS36	N/A	N/A	OPT-PBS36E12	OPT-PBS36E110	30" (3R)	¾"	310,000
48" Drop In Kit	OPT-PBS48	N/A	N/A	OPT-PBS48E12	OPT-PBS48E110	36" (3R)	¾"	375,000



Square Drop In Pan & SS Lotus Burner

ITEM	PAN & BURNER ONLY	FLAME SENSE MATCH LIT CERTIFIED	FLAME SENSE W/ SPARK IGNITION	ELECTRONIC 12V CSA CERTIFIED	ELECTRONIC 110V CSA CERTIFIED	BURNER SIZE	GAS INLET	BTU
16.5" Drop In Kit	OPT-PBSLF16	OPT-PBSLF16FSML	OPT-PBSLF16FSEN	OPT-PBSLF16E12	OPT-PBSLF16E110	12"	½"	90,000
18" Drop In Kit	OPT-PBSLF18	OPT-PBSLF18FSML	OPT-PBSLF18FSEN	OPT-PBSLF18E12	OPT-PBSLF18E110	12"	½"	100,000
24" Drop In Kit	OPT-PBSLF24	OPT-PBSLF24FSML	OPT-PBSLF24FSEN	OPT-PBSLF24E12	OPT-PBSLF24E110	18"	½"	160,000
30" Drop In Kit	OPT-PBSLF30	N/A	OPT-PBSLF30FSEN	OPT-PBSLF30E12	OPT-PBSLF30E110	24"	½"	190,000
36" Drop In Kit	OPT-PBSLF36	N/A	N/A	OPT-PBSLF36E12	OPT-PBSLF36E110	30"	¾"	260,000
48" Drop In Kit	OPT-PBSLF48	N/A	N/A	OPT-PBSLF48E12	OPT-PBSLF48E110	36"	¾"	350,000

Proudly Made In The USA



Suitable for either natural gas or liquid propane applications. Pans have 1" Lip & 2" Height. Electronic ignition systems require 10" clearance below the pan. 110V Ignition System Kits use a 3-prong grounded plug.

BURNER SIZE GUIDE: **M** = Double Inlet and uses manifold that adds 5" in height below the pan ; **2R** = 2 Rings ; **3R** = 3 Rings ; **4R** = 4 Rings



Rectangular Drop In Pan & SS Linear Burner

ITEM	PAN & BURNER ONLY	FLAME SENSE MATCH LIT CERTIFIED	FLAME SENSE W/ SPARK IGNITION	ELECTRONIC 12V CSA CERTIFIED	ELECTRONIC 110V CSA CERTIFIED	BURNER SIZE	GAS INLET	BTU
24"x6" Rectangle	OPT-RT24	OPT-RT24FSML	OPT-RT24FSEN	OPT-RT24E12	OPT-RT24E110	18"	½"	30,000
30"x6" Rectangle	OPT-RT30	OPT-RT30FSML	OPT-RT30FSEN	OPT-RT30E12	OPT-RT30E110	24"	½"	40,000
36"x6" Rectangle	OPT-RT36	OPT-RT36FSML	OPT-RT36FSEN	OPT-RT36E12	OPT-RT36E110	30"	½"	50,000
42"x6" Rectangle	OPT-RT42	OPT-RT42FSML	OPT-RT42FSEN	OPT-RT42E12	OPT-RT42E110	36"	½"	60,000
48"x6" Rectangle	OPT-RT48	OPT-RT48FSML	OPT-RT48FSEN	OPT-RT48E12	OPT-RT48E110	42"	½"	70,000
60"x6" Rectangle	OPT-RT60	OPT-RT60FSML	OPT-RT60FSEN	OPT-RT60E12	OPT-RT60E110	48"	½"	80,000
72"x6" Rectangle	OPT-RT72	OPT-RT72FSML	OPT-RT72FSEN	OPT-RT72E12	OPT-RT72E110	60"	½"	100,000
84"x6" Rectangle	OPT-RT84	N/A	N/A	OPT-RT84E12	OPT-RT84E110	72"	¾"	120,000
96"x6" Rectangle	OPT-RT96	N/A	N/A	OPT-RT96E12	OPT-RT96E110	84"	¾"	140,000



Rectangular Drop In Pan & SS 'H' Burner

ITEM	PAN & BURNER ONLY	FLAME SENSE MATCH LIT CERTIFIED	FLAME SENSE W/ SPARK IGNITION	ELECTRONIC 12V CSA CERTIFIED	ELECTRONIC 110V CSA CERTIFIED	BURNER SIZE	GAS INLET	BTU
24"x12" Rectangle	OPT-PB1224	OPT-PB1224FSML	OPT-PB1224FSEN	OPT-PB1224E12	OPT-PB1224E110	18" x 6"	½"	60,000
30"x12" Rectangle	OPT-PB1230	OPT-PB1230FSML	OPT-PB1230FSEN	OPT-PB1230E12	OPT-PB1230E110	24" x 6"	½"	80,000
36"x12" Rectangle	OPT-PB1236	OPT-PB1236FSML	OPT-PB1236FSEN	OPT-PB1236E12	OPT-PB1236E110	30" x 6"	½"	100,000
42"x12" Rectangle	OPT-PB1242	OPT-PB1242FSML	OPT-PB1242FSEN	OPT-PB1242E12	OPT-PB1242E110	36" x 6"	½"	120,000
48"x12" Rectangle	OPT-PB1248	N/A	N/A	OPT-PB1248E12	OPT-PB1248E110	42" x 6"	½"	140,000
60"x12" Rectangle	OPT-PB1260	N/A	N/A	OPT-PB1260E12	OPT-PB1260E110	48" x 6"	¾"	160,000
72"x12" Rectangle	OPT-PB1272	N/A	N/A	OPT-PB1272E12	OPT-PB1272E110	60" x 6"	¾"	200,000
84"x12" Rectangle	OPT-PB1284	N/A	N/A	OPT-PB1284E12	OPT-PB1284E110	72" x 6" (M)	¾"	240,000
96"x12" Rectangle	OPT-PB1296	N/A	N/A	OPT-PB1296E12	OPT-PB1296E110	84" x 6" (M)	¾"	240,000

DROP IN PAN & SS BURNER KITS

LIFETIME WARRANTY ON ALL BURNERS

Suitable for either natural gas or liquid propane applications. Pans have 1" Lip & 2" Height. Electronic ignition systems require 10" clearance below the pan. 110V Ignition System Kits use a 3-prong grounded plug.

BURNER SIZE GUIDE: M = Double Inlet and uses manifold that adds 5" in height below the pan ; 2R = 2 Rings ; 3R = 3 Rings ; 4R = 4 Rings

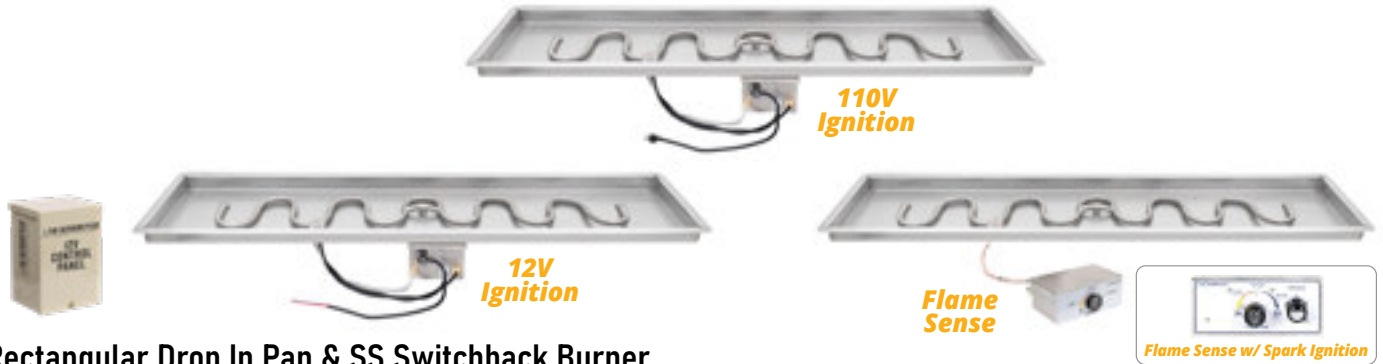







Rectangular Drop In Pan & SS Switchback Burner

ITEM	PAN & BURNER ONLY	FLAME SENSE MATCH LIT CERTIFIED	FLAME SENSE W/ SPARK IGNITION	ELECTRONIC 12V CSA CERTIFIED	ELECTRONIC 110V CSA CERTIFIED	BURNER SIZE	GAS INLET	BTU
24"x12" Rectangle	OPT-PBSB1224	OPT-PBSB1224FSML	OPT-PBSB1224FSEN	OPT-PBSB1224E12	OPT-PBSB1224E110	18" x 6"	½"	60,000
30"x12" Rectangle	OPT-PBSB1230	OPT-PBSB1230FSML	OPT-PBSB1230FSEN	OPT-PBSB1230E12	OPT-PBSB1230E110	24" x 6"	½"	80,000
36"x12" Rectangle	OPT-PBSB1236	OPT-PBSB1236FSML	OPT-PBSB1236FSEN	OPT-PBSB1236E12	OPT-PBSB1236E110	30" x 6"	½"	100,000
42"x12" Rectangle	OPT-PBSB1242	OPT-PBSB1242FSML	OPT-PBSB1242FSEN	OPT-PBSB1242E12	OPT-PBSB1242E110	36" x 6"	½"	120,000
48"x12" Rectangle	OPT-PBSB1248	N/A	N/A	OPT-PBSB1248E12	OPT-PBSB1248E110	42" x 6"	½"	140,000
60"x12" Rectangle	OPT-PBSB1260	N/A	N/A	OPT-PBSB1260E12	OPT-PBSB1260E110	48" x 6"	¾"	160,000
72"x12" Rectangle	OPT-PBSB1272	N/A	N/A	OPT-PBSB1272E12	OPT-PBSB1272E110	60" x 6" (M)	¾"	200,000
84"x12" Rectangle	OPT-PBSB1284	N/A	N/A	OPT-PBSB1284E12	OPT-PBSB1284E110	72" x 6" (M)	¾"	240,000
96"x12" Rectangle	OPT-PBSB1296	N/A	N/A	OPT-PBSB1296E12	OPT-PBSB1296E110	84" x 6" (M)	¾"	240,000

MORE ELECTRONIC IGNITION ACCESSORIES ON PAGES 155

MORE GAS ACCESSORIES ON PAGES 158

 REMOTE CONTROL & WIRELESS RECEIVER OPT-RC110V	 WEATHERPROOF ON/OFF SWITCH OPT-WPS110V	 110V EMERGENCY STOP BUTTON OPT-ESTOP	 110V 1-HOUR DIAL TIMER OPT-DTM	 GAS TIMER & EMERGENCY STOP OPT-ESTOPTM	 NATURAL GAS KIT OPT-NGKNG - 0-290K BTU OPT-NGKNGHC - 291K+ BTU	 LIQUID PROPANE KIT OPT-LPKLP - 0-290K BTU OPT-LPKLPHC - 291K+ BTU
--	---	---	---	---	---	---





Suitable for either natural gas or liquid propane applications. Pans have 1" x 1" Lip & 3" Height. Electronic ignition systems require 10" clearance below the pan. 110V Ignition System Kits use a 3-prong grounded plug.

BURNER SIZE GUIDE: **M** = Double Inlet and uses manifold that adds 5" in height below the pan ; **2R** = 2 Rings ; **3R** = 3 Rings ; **4R** = 4 Rings

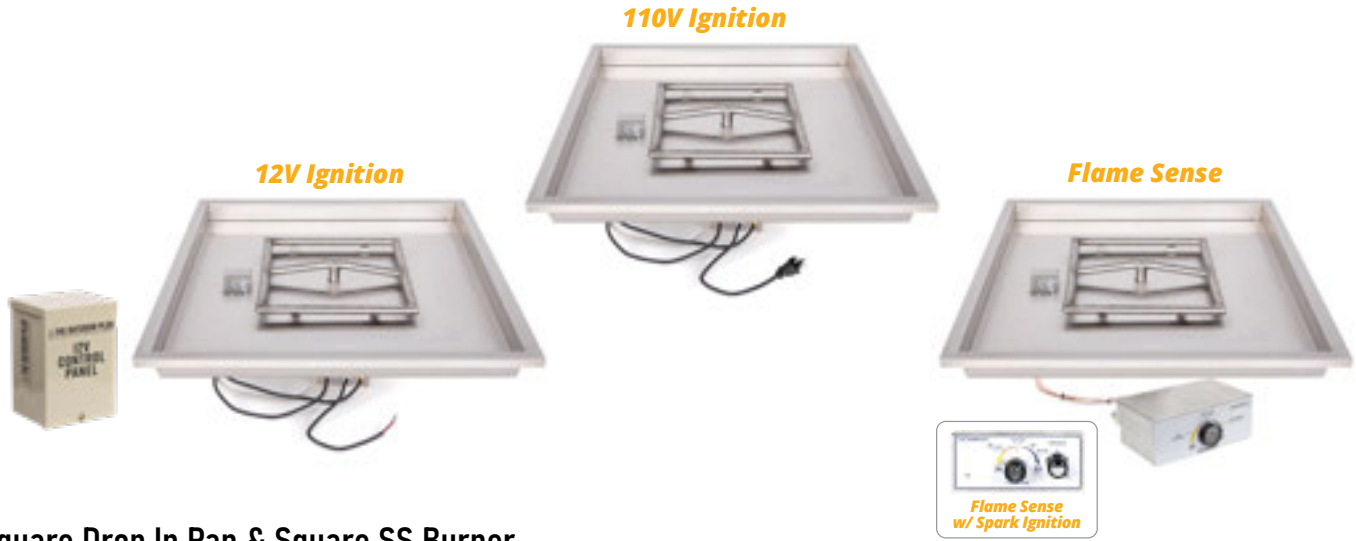

Square Drop In Pan & Square SS Burner

ITEM	PAN & BURNER ONLY	FLAME SENSE MATCH LIT CERTIFIED	FLAME SENSE W/ SPARK IGNITION	ELECTRONIC 12V CSA CERTIFIED	ELECTRONIC 110V CSA CERTIFIED	BURNER SIZE	GAS INLET	BTU
16.5" Drop In Kit	OPT-RLSQR16	OPT-RLSQR16FSML	OPT-RLSQR16FSEN	OPT-RLSQR16E12	OPT-RLSQR16E110	12"	½"	90,000
18" Drop In Kit	OPT-RLSQR18	OPT-RLSQR18FSML	OPT-RLSQR18FSEN	OPT-RLSQR18E12	OPT-RLSQR18E110	12"	½"	90,000
24" Drop In Kit	OPT-RLSQR24	OPT-RLSQR24FSML	OPT-RLSQR24FSEN	OPT-RLSQR24E12	OPT-RLSQR24E110	18" (2R)	½"	160,000
30" Drop In Kit	OPT-RLSQR30	N/A	OPT-RLSQR30FSEN	OPT-RLSQR30E12	OPT-RLSQR30E110	24" (2R)	½"	190,000
36" Drop In Kit	OPT-RLSQR36	N/A	N/A	OPT-RLSQR36E12	OPT-RLSQR36E110	30" (3R)	¾"	310,000
48" Drop In Kit	OPT-RLSQR48	N/A	N/A	OPT-RLSQR48E12	OPT-RLSQR48E110	36" (3R)	¾"	375,000





Rectangular Drop In Pan & SS Linear Burner

ITEM	PAN & BURNER ONLY	FLAME SENSE MATCH LIT CERTIFIED	FLAME SENSE W/ SPARK IGNITION	ELECTRONIC 12V CSA CERTIFIED	ELECTRONIC 110V CSA CERTIFIED	BURNER SIZE	GAS INLET	BTU
24"x8" Rectangle	OPT-RLRCT248	OPT-RLRCT248FSML	OPT-RLRCT248FSEN	OPT-RLRCT248E12	OPT-RLRCT248E110	18"	½"	30,000
30"x8" Rectangle	OPT-RLRCT308	OPT-RLRCT308FSML	OPT-RLRCT308FSEN	OPT-RLRCT308E12	OPT-RLRCT308E110	24"	½"	40,000
36"x8" Rectangle	OPT-RLRCT368	OPT-RLRCT368FSML	OPT-RLRCT368FSEN	OPT-RLRCT368E12	OPT-RLRCT368E110	30"	½"	50,000
42"x8" Rectangle	OPT-RLRCT428	OPT-RLRCT428FSML	OPT-RLRCT428FSEN	OPT-RLRCT428E12	OPT-RLRCT428E110	36"	½"	60,000
48"x8" Rectangle	OPT-RLRCT488	OPT-RLRCT488FSML	OPT-RLRCT488FSEN	OPT-RLRCT488E12	OPT-RLRCT488E110	42"	½"	70,000
60"x8" Rectangle	OPT-RLRCT608	OPT-RLRCT608FSML	OPT-RLRCT608FSEN	OPT-RLRCT608E12	OPT-RLRCT608E110	48"	½"	80,000
72"x8" Rectangle	OPT-RLRCT728	OPT-RLRCT728FSML	OPT-RLRCT728FSEN	OPT-RLRCT728E12	OPT-RLRCT728E110	60"	½"	100,000
84"x8" Rectangle	OPT-RLRCT848	N/A	N/A	OPT-RLRCT848E12	OPT-RLRCT848E110	72"	¾"	120,000
96"x8" Rectangle	OPT-RLRCT968	N/A	N/A	OPT-RLRCT968E12	OPT-RLRCT968E110	84"	¾"	140,000



Rectangular Drop In Pan & SS 'H' Burner

ITEM	PAN & BURNER ONLY	FLAME SENSE MATCH LIT CERTIFIED	FLAME SENSE W/ SPARK IGNITION	ELECTRONIC 12V CSA CERTIFIED	ELECTRONIC 110V CSA CERTIFIED	BURNER SIZE	GAS INLET	BTU
24"x12" Rectangle	OPT-RLRCT2412	OPT-RLRCT2412FSML	OPT-RLRCT2412FSEN	OPT-RLRCT2412E12	OPT-RLRCT2412E110	18" x 6"	½"	30,000
30"x12" Rectangle	OPT-RLRCT3012	OPT-RLRCT3012FSML	OPT-RLRCT3012FSEN	OPT-RLRCT3012E12	OPT-RLRCT3012E110	24" x 6"	½"	40,000
36"x12" Rectangle	OPT-RLRCT3612	OPT-RLRCT3612FSML	OPT-RLRCT3612FSEN	OPT-RLRCT3612E12	OPT-RLRCT3612E110	30" x 6"	½"	50,000
42"x12" Rectangle	OPT-RLRCT4212	OPT-RLRCT4212FSML	OPT-RLRCT4212FSEN	OPT-RLRCT4212E12	OPT-RLRCT4212E110	36" x 6"	½"	60,000
48"x12" Rectangle	OPT-RLRCT4812	N/A	N/A	OPT-RLRCT4812E12	OPT-RLRCT4812E110	42" x 6"	½"	70,000
60"x12" Rectangle	OPT-RLRCT6012	N/A	N/A	OPT-RLRCT6012E12	OPT-RLRCT6012E110	48" x 6"	½"	80,000
72"x12" Rectangle	OPT-RLRCT7212	N/A	N/A	OPT-RLRCT7212E12	OPT-RLRCT7212E110	60" x 6"	½"	100,000
84"x12" Rectangle	OPT-RLRCT8412	N/A	N/A	OPT-RLRCT8412E12	OPT-RLRCT8412E110	72" x 6" (M)	¾"	120,000
96"x12" Rectangle	OPT-RLRCT9612	N/A	N/A	OPT-RLRCT9612E12	OPT-RLRCT9612E110	84" x 6" (M)	¾"	140,000



Suitable for either natural gas or liquid propane applications. Pans have 2" Height. Electronic ignition systems require 10" clearance below the pan. 110V Ignition System Kits use a 3-prong grounded plug.

BURNER SIZE GUIDE: **M** = Double Inlet and uses manifold that adds 5" in height below the pan ; **2R** = 2 Rings ; **3R** = 3 Rings ; **4R** = 4 Rings



Square Drop In Pan & Square SS Burner

ITEM	PAN & BURNER ONLY	FLAME SENSE MATCH LIT CERTIFIED	FLAME SENSE W/ SPARK IGNITION	ELECTRONIC 12V CSA CERTIFIED	ELECTRONIC 110V CSA CERTIFIED	BURNER SIZE	GAS INLET	BTU
16.5" Pan Kit	OPT-LTSQR16	OPT-LTSQR16FSML	OPT-LTSQR16FSEN	OPT-LTSQR16E12	OPT-LTSQR16E110	12"	½"	90,000
18" Pan Kit	OPT-LTSQR18	OPT-LTSQR18FSML	OPT-LTSQR18FSEN	OPT-LTSQR18E12	OPT-LTSQR18E110	12"	½"	90,000
24" Pan Kit	OPT-LTSQR24	OPT-LTSQR24FSML	OPT-LTSQR24FSEN	OPT-LTSQR24E12	OPT-LTSQR24E110	18" (2R)	½"	160,000
30" Pan Kit	OPT-LTSQR30	N/A	OPT-LTSQR30FSEN	OPT-LTSQR30E12	OPT-LTSQR30E110	24" (2R)	½"	190,000
36" Pan Kit	OPT-LTSQR36	N/A	N/A	OPT-LTSQR36E12	OPT-LTSQR36E110	30" (3R)	¾"	310,000
48" Pan Kit	OPT-LTSQR48	N/A	N/A	OPT-LTSQR48E12	OPT-LTSQR48E110	36" (3R)	¾"	375,000



Round Drop In Pan & Round SS Burner

ITEM	PAN & BURNER ONLY	FLAME SENSE MATCH LIT CERTIFIED	FLAME SENSE W/ SPARK IGNITION	ELECTRONIC 12V CSA CERTIFIED	ELECTRONIC 110V CSA CERTIFIED	BURNER SIZE	GAS INLET	BTU
12" Pan Kit	OPT-LTROR12	OPT-LTROR12FSML	OPT-LTROR12FSEN	OPT-LTROR12E12	OPT-LTROR12E110	6"	½"	65,000
18" Pan Kit	OPT-LTROR18	OPT-LTROR18FSML	OPT-LTROR18FSEN	OPT-LTROR18E12	OPT-LTROR18E110	12"	½"	90,000
24" Pan Kit	OPT-LTROR24	OPT-LTROR24FSML	OPT-LTROR24FSEN	OPT-LTROR24E12	OPT-LTROR24E110	18" (2R)	½"	160,000
30" Pan Kit	OPT-LTROR30	N/A	OPT-LTROR30FSEN	OPT-LTROR30E12	OPT-LTROR30E110	24" (2R)	½"	190,000
36" Pan Kit	OPT-LTROR36	N/A	N/A	OPT-LTROR36E12	OPT-LTROR36E110	30" (3R)	¾"	310,000
48" Pan Kit	OPT-LTROR48	N/A	N/A	OPT-LTROR48E12	OPT-LTROR48E110	36" (3R)	¾"	375,000

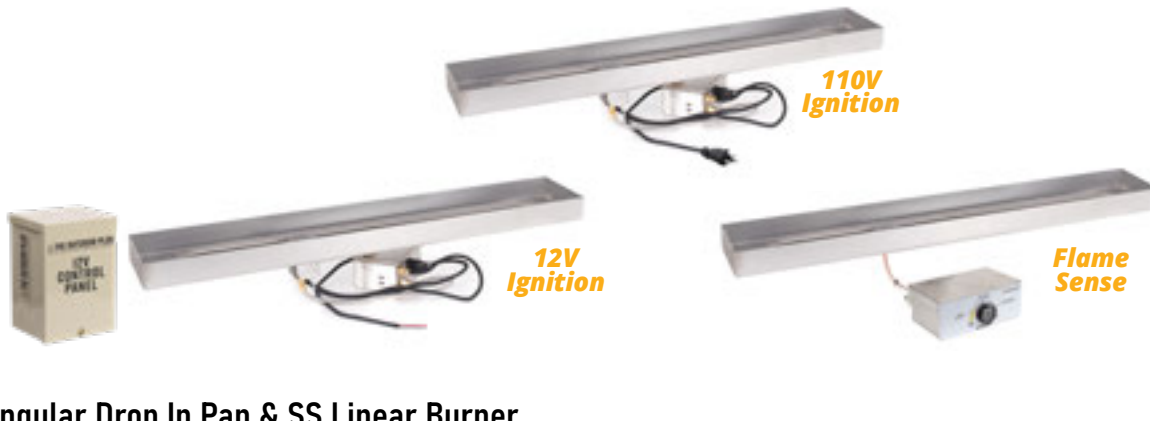

Rectangular Drop In Pan & SS Linear Burner

ITEM	PAN & BURNER ONLY	FLAME SENSE MATCH LIT CERTIFIED	FLAME SENSE W/ SPARK IGNITION	ELECTRONIC 12V CSA CERTIFIED	ELECTRONIC 110V CSA CERTIFIED	BURNER SIZE	GAS INLET	BTU
24"x6" Pan Kit	OPT-LTRCT246	OPT-LTRCT246FSML	OPT-LTRCT246FSEN	OPT-LTRCT246E12	OPT-LTRCT246E110	18"	½"	30,000
30"x6" Pan Kit	OPT-LTRCT306	OPT-LTRCT306FSML	OPT-LTRCT306FSEN	OPT-LTRCT306E12	OPT-LTRCT306E110	24"	½"	40,000
36"x6" Pan Kit	OPT-LTRCT366	OPT-LTRCT366FSML	OPT-LTRCT366FSEN	OPT-LTRCT366E12	OPT-LTRCT366E110	30"	½"	50,000
42"x6" Pan Kit	OPT-LTRCT426	OPT-LTRCT426FSML	OPT-LTRCT426FSEN	OPT-LTRCT426E12	OPT-LTRCT426E110	36"	½"	60,000
48"x6" Pan Kit	OPT-LTRCT486	OPT-LTRCT486FSML	OPT-LTRCT486FSEN	OPT-LTRCT486E12	OPT-LTRCT486E110	42"	½"	70,000
60"x6" Pan Kit	OPT-LTRCT606	OPT-LTRCT606FSML	OPT-LTRCT606FSEN	OPT-LTRCT606E12	OPT-LTRCT606E110	48"	½"	80,000
72"x6" Pan Kit	OPT-LTRCT726	OPT-LTRCT726FSML	OPT-LTRCT726FSEN	OPT-LTRCT726E12	OPT-LTRCT726E110	60"	½"	100,000
84"x6" Pan Kit	OPT-LTRCT846	N/A	N/A	OPT-LTRCT846E12	OPT-LTRCT846E110	72"	¾"	120,000
96"x6" Pan Kit	OPT-LTRCT966	N/A	N/A	OPT-LTRCT966E12	OPT-LTRCT966E110	84"	¾"	140,000



Rectangular Drop In Pan & SS 'H' Burner

ITEM	PAN & BURNER ONLY	FLAME SENSE MATCH LIT CERTIFIED	FLAME SENSE W/ SPARK IGNITION	ELECTRONIC 12V CSA CERTIFIED	ELECTRONIC 110V CSA CERTIFIED	BURNER SIZE	GAS INLET	BTU
24"x12" Pan Kit	OPT-LTRCT2412	OPT-LTRCT2412FSML	OPT-LTRCT2412FSEN	OPT-LTRCT2412E12	OPT-LTRCT2412E110	18" x 6"	½"	30,000
30"x12" Pan Kit	OPT-LTRCT3012	OPT-LTRCT3012FSML	OPT-LTRCT3012FSEN	OPT-LTRCT3012E12	OPT-LTRCT3012E110	24" x 6"	½"	40,000
36"x12" Pan Kit	OPT-LTRCT3612	OPT-LTRCT3612FSML	OPT-LTRCT3612FSEN	OPT-LTRCT3612E12	OPT-LTRCT3612E110	30" x 6"	½"	50,000
42"x12" Pan Kit	OPT-LTRCT4212	OPT-LTRCT4212FSML	OPT-LTRCT4212FSEN	OPT-LTRCT4212E12	OPT-LTRCT4212E110	36" x 6"	½"	60,000
48"x12" Pan Kit	OPT-LTRCT4812	N/A	N/A	OPT-LTRCT4812E12	OPT-LTRCT4812E110	42" x 6"	½"	70,000
60"x12" Pan Kit	OPT-LTRCT6012	N/A	N/A	OPT-LTRCT6012E12	OPT-LTRCT6012E110	48" x 6"	½"	80,000
72"x12" Pan Kit	OPT-LTRCT7212	N/A	N/A	OPT-LTRCT7212E12	OPT-LTRCT7212E110	60" x 6"	½"	100,000
84"x12" Pan Kit	OPT-LTRCT8412	N/A	N/A	OPT-LTRCT8412E12	OPT-LTRCT8412E110	72" x 6" (M)	¾"	120,000
96"x12" Pan Kit	OPT-LTRCT9612	N/A	N/A	OPT-LTRCT9612E12	OPT-LTRCT9612E110	84" x 6" (M)	¾"	140,000

The Outdoor Plus' **Water-Over-Fire Pit Insert** is your solution to creating a unique fire feature. Its simple form allows it to drop into place like any other drop in pan, and its plug & play features allows for easy installation and operation.

The **Water-Over-Fire Kit** features all components necessary for plug & play operation: Burner, Water Ring, Water Lines, Water Drain, Water Pump (110V), Filter & Debris Catcher. 1/2" MIP gas Inlet. All water over fire kits are NG or LP compatible.



PART #	DIAMETER	MINIMUM CUT-OUT	HEIGHT	SUGG. GLASS	BTU
OPT-300-WOFKIT-25	25"	25.5"	18"	35 lbs.	110,000
OPT-300-WOFKIT-31	31"	31.5"	18"	45 lbs.	130,000
OPT-300-WOFKIT-37	37"	37.5"	18"	55 lbs.	160,000

The water reservoirs requires an 18" clearance below.

UNIT OVERVIEW

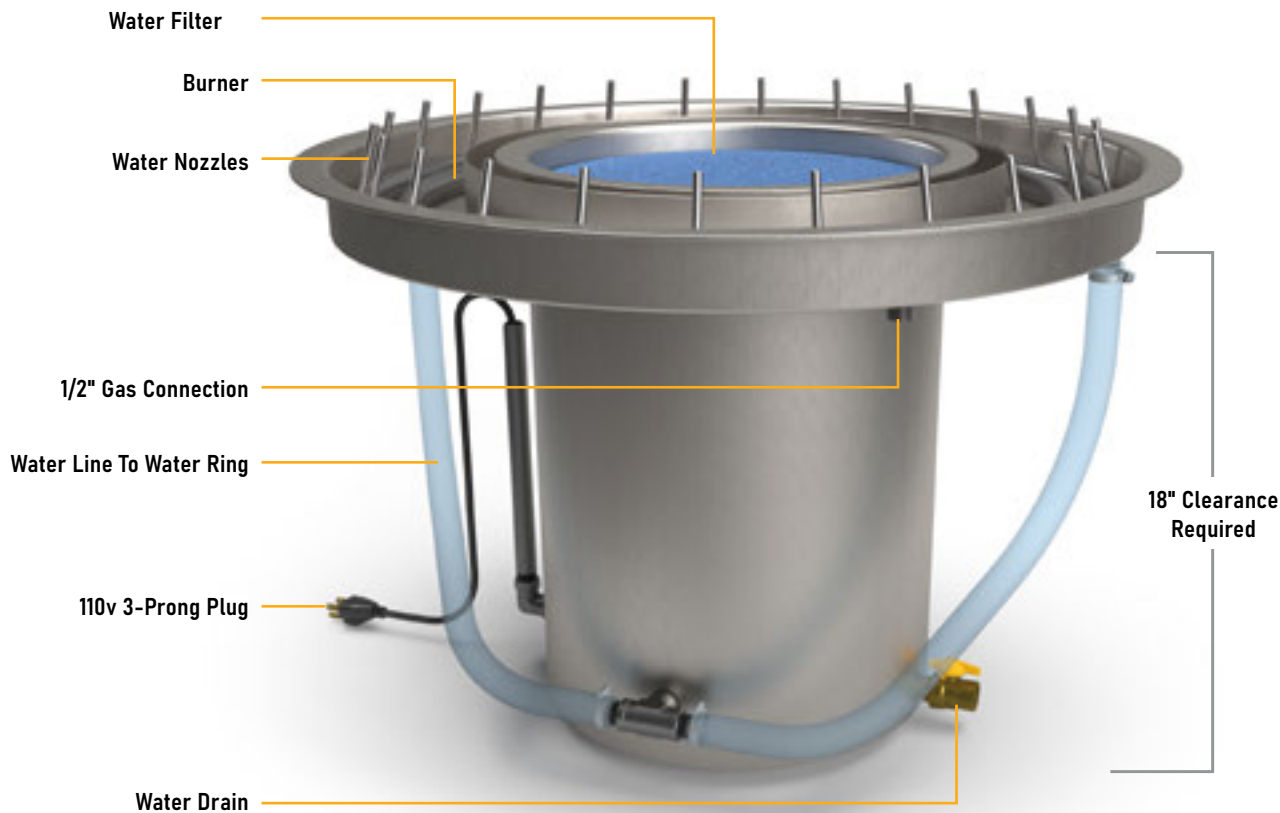



Our Patented Bullet Burner is the perfect way to get more out of any pre-existing fire pit. Its 1/2" gas inlet makes it easy to swap out with any pre-existing burner.

You can expect to get the same flame height while using less gas than your standard burner, or crank it up for a dramatic and impressive flame, taller than any standard burner is able to produce.



Uniform Gas Flow Generator

Our Patented Hub Distributes Gas Evenly Throughout The Burner

Curved Design

Distributes The Bullet Orifices Evenly To Create A Fuller Flame

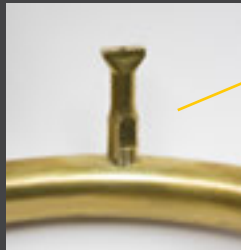

BULLET ORIFICE FLAME SPREADER

Precision Machined Components

Gives You Consistent Quality & Durability That You Can Rely On

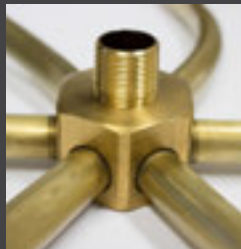

Flat Flame Technology

Our Patented Bullet Orifice Compresses Gas Flow & Incorporates Oxygen To Create A Cleaner Flame

Individually Assembled

Quality Control To Provide You With A Great Product Every Single Time



IMPORT BURNER



PATENTED BULLET BURNER

The Patented Bullet Burner's eliminate the need for an additional LP air mixer. Suitable for either natural gas or liquid propane applications. Pans have 1" Lip & 2" Height. Electronic ignition require 10" clearance below the pan. 110V Ignition System Kits use a 3-prong grounded plug.

BURNER SIZE GUIDE: **M** = Double Inlet and uses manifold that adds 5" in height below the pan ; **2R** = 2 Rings ; **3R** = 3 Rings ; **4R** = 4 Rings



Triple 'S' Burner - Brass & Stainless Steel

PART # (BRASS)	PART # (STAINLESS)	DIAMETER	BTU	INLET
OPT-B8B	OPT-B8SS	8"	40,000	½"
OPT-B12B	OPT-B12SS	12"	60,000	½"
OPT-B18B	OPT-B18SS	18"	90,000	½"
OPT-B24B	OPT-B24SS	24"	120,000	½"
OPT-B30B	OPT-B30SS	30"	150,000	½"
OPT-B36B	OPT-B36SS	36"	240,000	¾"
OPT-B48B	OPT-B48SS	48"	320,000	¾"



Linear Brass Bullet Burner

PART # (BRASS)	PART # (STAINLESS)	LENGTH	BTU	INLET
OPT-B18BT	OPT-B18SST	18"	30,000	½"
OPT-B24BT	OPT-B24SST	24"	40,000	½"
OPT-B30BT	OPT-B30SST	30"	50,000	½"
OPT-B36BT	OPT-B36SST	36"	60,000	½"
OPT-B48BT	OPT-B48SST	48"	80,000	½"
OPT-B60BT	OPT-B60SST	60"	100,000	½"
OPT-B72BT	OPT-B72SST	72"	120,000	½"
OPT-B84BT	OPT-B84SST	84"	140,000	¾"
OPT-B96BT	OPT-B96SST	96" (M)	160,000	¾"



'H' Brass Bullet Burner

PART # (BRASS)	PART # (STAINLESS)	LENGTH	WIDTH	BTU	INLET
OPT-B18BH	OPT-B18SSH	18"	6"	70,000	½"
OPT-B24BH	OPT-B24SSH	24"	6"	90,000	½"
OPT-B30BH	OPT-B30SSH	30"	6"	110,000	½"
OPT-B36BH	OPT-B36SSH	36"	6"	130,000	½"
OPT-B48BH	OPT-B48SSH	48"	6"	170,000	½"
OPT-B60BH	OPT-B60SSH	60" (M)	6"	210,000	¾"
OPT-B72BH	OPT-B72SSH	72" (M)	6"	250,000	¾"



BURNER SIZE GUIDE: **M** = Double Inlet and uses manifold that adds 5" in height below the pan ; **2R** = 2 Rings ; **3R** = 3 Rings ; **4R** = 4 Rings



Square Stainless Bullet Burner

PART #	SIZE	BTU	INLET
OPT-BSQSS8	8"	55,000	½"
OPT-BSQSS12	12"	80,000	½"
OPT-BSQSS18	18" (2R)	20,000	½"
OPT-BSQSS24	24" (2R)	240,000	½"
OPT-BSQSS30	30" (3R)	420,000	½"
OPT-BSQSS36	36" (3R)	480,000	¾"
OPT-BSQSS48	48" (4R, M)	80,000	¾"



Round Stainless Bullet Burner

PART #	SIZE	BTU	INLET
OPT-BRDSS8	8"	45,000	½"
OPT-BRDSS12	12"	65,000	½"
OPT-BRDSS18	18" (2R)	160,000	½"
OPT-BRDSS24	24" (2R)	190,000	½"
OPT-BRDSS30	30" (3R)	330,000	½"
OPT-BRDSS36	36" (3R)	380,000	¾"
OPT-BRDSS48	48" (4R, M)	630,000	¾"



Switchback Stainless Bullet Burner

PART #	SIZE	BTU	INLET
OPT-BSWSS18	18" x 6"	60,000	½"
OPT-BSWSS24	24" x 6"	75,000	½"
OPT-BSWSS30	30" x 6"	90,000	½"
OPT-BSWSS36	36" x 6"	105,000	½"
OPT-BSWSS48	48" x 6"	140,000	½"
OPT-BSWSS60	60" x 6" (M)	170,000	¾"
OPT-BSWSS72	72" x 6" (M)	200,000	¾"



Racetrack Stainless Bullet Burner

PART #	SIZE	BTU	INLET
OPT-BRTSS186	18" x 6"	70,000	½"
OPT-BRTSS246	24" x 6"	90,000	½"
OPT-BRTSS306	30" x 6"	110,000	½"
OPT-BRTSS366	36" x 6"	130,000	½"
OPT-BRTSS486	48" x 6"	170,000	½"
OPT-BRTSS606	60" x 6" (M)	210,000	¾"
OPT-BRTSS726	72" x 6" (M)	250,000	¾"

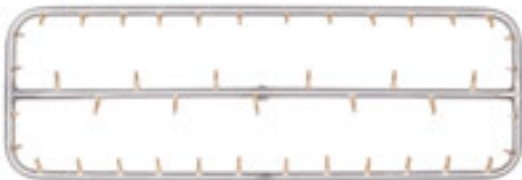

Rectangle Stainless Bullet Burner

PART #	SIZE	BTU	INLET
OPT-BRTSS1812	18" x 12"	130,000	½"
OPT-BRTSS2412	24" x 12"	160,000	½"
OPT-BRTSS3012	30" x 12"	190,000	½"
OPT-BRTSS3612	36" x 12"	220,000	¾"
OPT-BRTSS4812	48" x 12" (M)	280,000	¾"
OPT-BRTSS6012	60" x 12" (M)	340,000	¾"
OPT-BRTSS7212	72" x 12" (M)	400,000	¾"

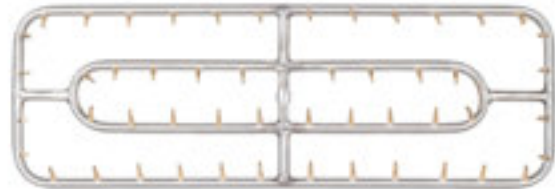

Double Rectangle Stainless Bullet Burner

PART #	SIZE	BTU	INLET
OPT-BDRTSS1812	18" x 12"	190,000	½"
OPT-BDRTSS2412	24" x 12"	240,000	½"
OPT-BDRTSS3012	30" x 12"	290,000	½"
OPT-BDRTSS3612	36" x 12"	340,000	¾"
OPT-BDRTSS4812	48" x 12"	440,000	¾"
OPT-BDRTSS6012	60" x 12" (M)	540,000	¾"
OPT-BDRTSS7212	72" x 12" (M)	640,000	¾"



**STANDARD 18" STAINLESS
STEEL H-BURNER**

**BRASS BULLET BURNER
18" H-BURNER**



Our fire burners are individually crafted from 304 stainless steel. T.O.P's burner holes are individually drilled, not punched, creating a better flame. Gas Inlets are slightly raised to prevent water from entering your gas line. NG or LP compatible. Made in the USA.

BURNER SIZE GUIDE: **M** = Double Inlet and uses manifold that adds 5" in height below the pan ; **2R** = 2 Rings ; **3R** = 3 Rings ; **4R** = 4 Rings



Round Burner

PART #	SIZE	INLET	BTUS
OPT-158-5	5"	1/2"	30,000
OPT-158	6"	1/2"	35,000
OPT-158-8	8"	1/2"	45,000
OPT-159	12"	1/2"	65,000
OPT-160	18" (2R)	1/2"	160,000
OPT-161	24" (2R)	1/2"	190,000
OPT-161-30	30" (3R)	3/4"	330,000
OPT-162	36" (3R)	3/4"	380,000
OPT-162-48	48" (4R) (M)	3/4"	630,000



Triple "S" Star Burner

PART #	SIZE	INLET	BTUS
OPT-3S12	12"	1/2"	60,000
OPT-3S18	18"	1/2"	90,000
OPT-3S24	24"	1/2"	120,000
OPT-3S30	30"	3/4"	150,000
OPT-3S36	36"	3/4"	180,000
OPT-3S42	42"	3/4"	210,000
OPT-3S48	48"	3/4"	240,000



"H" Burner

PART #	SIZE	INLET	BTUS
OPT-181	6" x 18"	1/2"	70,000
OPT-182	6" x 24"	1/2"	90,000
OPT-183	6" x 30"	1/2"	110,000
OPT-184	6" x 36"	1/2"	130,000
OPT-18448	6" x 48"	3/4"	170,000
OPT-18466	6" x 60" (M)	3/4"	210,000
OPT-18472	6" x 72" (M)	3/4"	250,000
OPT-18484	6" x 84" (M)	3/4"	290,000
OPT-18496	6" x 96" (M)	3/4"	410,000



"T" Burner

PART #	SIZE	INLET	BTUS
OPT-16616	16"	1/2"	30,000
OPT-167	24"	1/2"	40,000
OPT-168	30"	1/2"	50,000
OPT-169	36"	1/2"	60,000
OPT-166T48	48"	1/2"	80,000
OPT-166T60	60"	1/2"	100,000
OPT-166T72	72"	3/4"	120,000
OPT-166T84	84"	3/4"	140,000
OPT-166T96	96" (M)	3/4"	160,000
OPT-166T108	108" (M)	3/4"	180,000
OPT-166T120	120" (M)	3/4"	200,000



S-Burner

PART #	SIZE	INLET	BTUS
OPT-3013	6" x 18"	1/2"	50,000
OPT-3014	6" x 24"	1/2"	50,000
OPT-301530	6" x 30"	1/2"	75,000
OPT-3015	6" x 36"	1/2"	90,000
OPT-3016	6" x 48"	1/2"	100,000
OPT-301660	6" x 60"	3/4"	120,000
OPT-3017	6" x 72"	3/4"	150,000
OPT-301784	6" x 84"	3/4"	150,000
OPT-301796	6" x 96" (M)	3/4"	200,000
OPT-3017108	6" x 108" (M)	3/4"	200,000
OPT-3017120	6" x 120" (M)	3/4"	200,000



Half Moon Burner

PART #	SIZE	INLET	BTUS
OPT-HM18	18" x 9" (2R)	1/2"	80,000
OPT-HM24	24" x 12" (2R)	1/2"	90,000
OPT-HM30	30" x 15" (3R)	1/2"	120,000
OPT-HM36	36" x 18" (3R)	3/4"	140,000
OPT-HM42	42" x 21" (4R)	3/4"	150,000
OPT-HM48	48" x 24" (4R)	3/4"	175,000



Square Burner

PART #	SIZE	INLET	BTUS
OPT-30076	6" x 6"	1/2"	40,000
OPT-3007	12" x 12" (2R)	1/2"	80,000
OPT-3008	18" x 18" (2R)	1/2"	200,000
OPT-3009	24" x 24" (2R)	1/2"	240,000
OPT-300930	30" x 30" (3R)	3/4"	420,000
OPT-300936	36" x 36" (3R)	3/4"	480,000
OPT-300942	42" x 42" (3R)	3/4"	540,000
OPT-300948	48" x 48" (4R) (M)	3/4"	800,000
OPT-300960	60" x 60" (4R) (M)	3/4"	1.1M



Triangle Burner

PART #	SIZE	INLET	BTUS
OPT-3001	12"	1/2"	60,000
OPT-3002	18" (2R)	1/2"	150,000
OPT-3003	24" (2R)	1/2"	180,000
OPT-300330	30" (3R)	3/4"	315,000
OPT-3004	36" (3R)	3/4"	360,000
OPT-300448	48" (4R)	3/4"	600,000



Rectangle Burner

PART #	SIZE	INLET	BTUS
OPT-3010	6" x 12"	1/2"	60,000
OPT-3011	6" x 18"	1/2"	80,000
OPT-301124	6" x 24"	1/2"	100,000
OPT-301130	6" x 30"	1/2"	120,000
OPT-301136	6" x 36"	1/2"	140,000
OPT-301148	6" x 48"	3/4"	180,000
OPT-3012	12" x 24"	1/2"	120,000
OPT-301230	12" x 30"	1/2"	140,000
OPT-301236	12" x 36"	1/2"	160,000
OPT-301242	12" x 42"	1/2"	180,000
OPT-301248	12" x 48"	3/4"	200,000
OPT-301260	12" x 60" (M)	3/4"	240,000
OPT-301272	12" x 72" (M)	3/4"	280,000

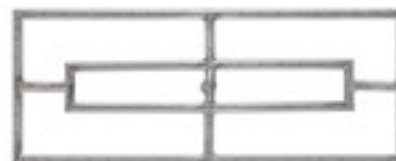

Double Rectangle Burner

PART #	SIZE	INLET	BTUS
OPT-DR1224	12" x 24"	1/2"	200,000
OPT-DR1230	12" x 30"	1/2"	240,000
OPT-DR1236	12" x 36"	1/2"	280,000
OPT-DR1242	12" x 42"	1/2"	320,000
OPT-DR1248	12" x 48"	3/4"	360,000
OPT-DR1260	12" x 60"	3/4"	440,000
OPT-DR1272	12" x 72"	3/4"	520,000
OPT-DR1830	18" x 30"	1/2"	280,000
OPT-DR1836	18" x 36"	1/2"	320,000
OPT-DR1842	18" x 42"	1/2"	360,000
OPT-DR1848	18" x 48"	3/4"	400,000
OPT-DR1860	18" x 60" (M)	3/4"	480,000



Lotus Burner

PART #	SIZE	INLET	BTUS
OPT-18LTS	18"	1/2"	125,000
OPT-24LTS	24"	1/2"	150,000
OPT-30LTS	30"	1/2"	200,000
OPT-36LTS	36"	3/4"	220,000
OPT-42LTS	42"	3/4"	260,000
OPT-48LTS	48"	3/4"	300,000



Star Burner

PART #	SIZE	INLET	BTU
OPT-171	12"	1/2"	90,000
OPT-171A	16"	1/2"	90,000
OPT-17118	18"	1/2"	90,000
OPT-172	24"	1/2"	150,000
OPT-17230	30"	3/4"	200,000
OPT-17236	36"	3/4"	300,000
OPT-17248	48"	3/4"	300,000

Our fire burners are individually crafted from 304 stainless steel. T.O.P's burner holes are individually drilled, not punched, creating a better flame. Gas Inlets are slightly raised to prevent water from entering your gas line. NG or LP compatible. Made in the USA.

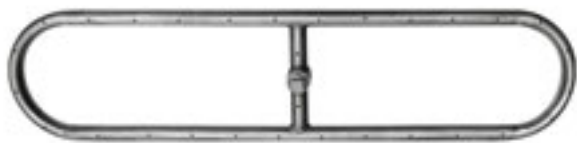

Racetrack Steel Burner

PART #	SIZE	INLET	BTUS
OPT-RT618	6" x 18"	1/2"	50,000
OPT-RT624	6" x 24"	1/2"	60,000
OPT-RT630	6" x 30"	1/2"	70,000
OPT-RT636	6" x 36"	1/2"	90,000
OPT-RT648	6" x 48"	1/2"	100,000
OPT-RT1224	12" x 24"	1/2"	80,000
OPT-RT1230	12" x 30"	1/2"	90,000
OPT-RT1236	12" x 36"	1/2"	90,000
OPT-RT1242	12" x 42"	1/2"	100,000
OPT-RT1248	12" x 48"	1/2"	180,000
OPT-RT1254	12" x 54"	3/4"	190,000
OPT-RT1260	12" x 60" (M)	3/4"	200,000
OPT-RT1272	12" x 72" (M)	3/4"	240,000



Double Racetrack Burner

PART #	SIZE	INLET	BTUS
OPT-DRT1224	12" x 24"	1/2"	90,000
OPT-DRT1230	12" x 30"	1/2"	90,000
OPT-DRT1236	12" x 36"	1/2"	100,000
OPT-DRT1242	12" x 42"	1/2"	120,000
OPT-DRT1248	12" x 48"	3/4"	140,000
OPT-DRT1254	12" x 54"	3/4"	200,000
OPT-DRT1260	12" x 60" (M)	3/4"	220,000
OPT-DRT1272	12" x 72" (M)	3/4"	220,000
OPT-DRT1830	18" x 30"	3/4"	100,000
OPT-DRT1836	18" x 36"	3/4"	120,000
OPT-DRT1842	18" x 42"	3/4"	120,000
OPT-DRT1848	18" x 48"	3/4"	180,000
OPT-DRT1860	18" x 60" (M)	3/4"	190,000
OPT-DRT1872	18" x 72" (M)	3/4"	200,000
OPT-DRT1884	18" x 84" (M)	3/4"	200,000



Switch Back Burner

PART #	SIZE	INLET	BTUS
OPT-SB18	7" x 18"	1/2"	65,000
OPT-SB24	7" x 24"	1/2"	75,000
OPT-SB30	7" x 30"	1/2"	90,000
OPT-SB36	7" x 36"	1/2"	100,000
OPT-SB48	7" x 48"	1/2"	120,000
OPT-SB60	7" x 60" (M)	3/4"	160,000
OPT-SB72	7" x 72" (M)	3/4"	200,000
OPT-SB84	7" x 84" (M)	3/4"	240,000
OPT-SB96	7" x 96" (M)	3/4"	280,000
OPT-SB108	7" x 108" (M)	3/4"	320,000
OPT-SB120	7" x 120" (M)	3/4"	400,000
OPT-SB2412	12" x 24" (M)	1/2"	65,000
OPT-SB3012	12" x 30"	1/2"	75,000
OPT-SB3612	12" x 36"	1/2"	90,000
OPT-SB4812	12" x 48"	1/2"	100,000
OPT-SB6012	12" x 60" (M)	3/4"	120,000
OPT-SB7212	12" x 72" (M)	3/4"	160,000
OPT-SB8412	12" x 84" (M)	3/4"	200,000
OPT-SB9612	12" x 96" (M)	3/4"	240,000
OPT-SB10812	12" x 108" (M)	3/4"	280,000
OPT-SB12012	12" x 120" (M)	3/4"	400,000



Fish Eye Burner

PART #	SIZE	INLET	BTUS
OPT-FE18	6" x 18"	1/2"	70,000
OPT-FE24	6" x 24"	1/2"	70,000
OPT-FE30	6" x 30"	1/2"	90,000
OPT-FE36	6" x 36"	1/2"	150,000
OPT-FE48	6" x 48"	1/2"	150,000



Double Fish Eye Burner

PART #	SIZE	INLET	BTUS
OPT-FE24D	12" x 24"	1/2"	100,000
OPT-FE36D	12" x 36"	1/2"	140,000
OPT-FE48D	12" x 48"	3/4"	180,000
OPT-FE60D	12" x 60"	3/4"	200,000

BURNER SIZE GUIDE: **M** = Double Inlet and uses manifold that adds 5" in height below the pan ; **2R** = 2 Rings ; **3R** = 3 Rings ; **4R** = 4 Rings



Wheel Burner

PART #	SIZE	INLET	BTUS
OPT-W18	18"	1/2"	125,000
OPT-W24	24"	1/2"	150,000
OPT-W30	30"	1/2"	200,000
OPT-W36	36"	3/4"	220,000
OPT-W42	42"	3/4"	260,000
OPT-W48	48"	3/4"	300,000



Single Ring Burner

PART #	SIZE	INLET	BTUS
OPT-12SR	12"	1/2"	60,000
OPT-18SR	18"	1/2"	70,000
OPT-24SR	24"	1/2"	80,000
OPT-30SR	30"	1/2"	90,000
OPT-36SR	36"	3/4"	90,000
OPT-42SR	42"	3/4"	100,000
OPT-48SR	48"	3/4"	100,000

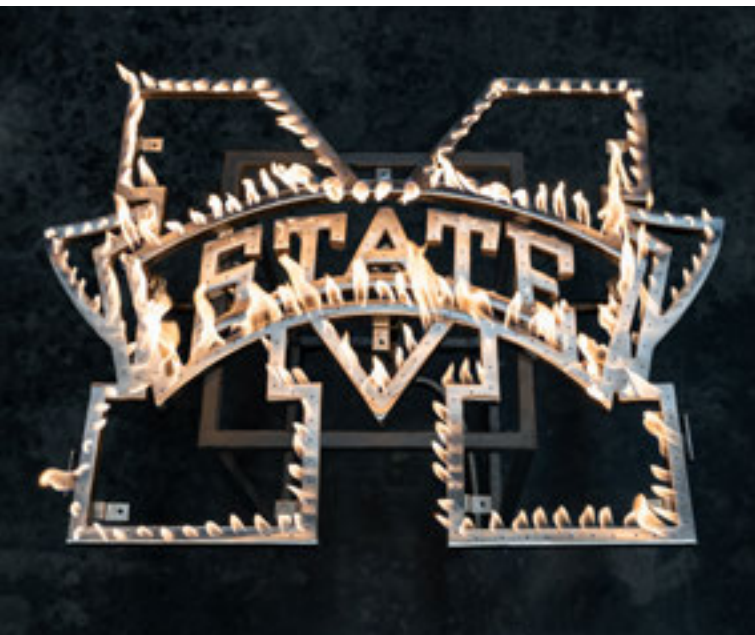

Custom Burners Any Size, Any Shape

Do you need a specific size? Do you have an logo or design that you would like created in burner form? We can do that for you!

We manufacture all of T.O.P's products in house and that allows us to build practically anything. Design it yourself or send in pencil sketches and T.O.P's in house specialist can design it for you. Email or call us today to learn more!





Fireplace Log Lighter Burner

PART #	SIZE	INLET	BTUS
OPT-173-12	12"	1/2"	20,000
OPT-173	18"	1/2"	30,000
OPT-174	24"	1/2"	40,000
OPT-175	30"	1/2"	50,000
OPT-17536	36"	1/2"	60,000
OPT-17542	42"	1/2"	70,000
OPT-17548	48"	1/2"	80,000
OPT-17560	60"	3/4"	100,000

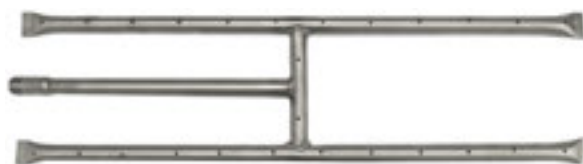

Fireplace H-Burner

PART #	SIZE	INLET	BTUS
OPT-154	6" x 18"	1/2"	70,000
OPT-155	6" x 24"	1/2"	90,000
OPT-156	6" x 30"	1/2"	110,000
OPT-157	6" x 36"	1/2"	130,000
OPT-15748	12" x 48"	3/4"	170,000
OPT-15760	12" x 60"	3/4"	210,000
OPT-15772	12" x 72"	3/4"	250,000



Stainless Steel Whistle Free Hose

Includes: Hose, Flare to Non-Flared Fittings. Max 1/2 PSI

LENGTH	3/8" HOSE (1/2" FITTINGS)	1/2" HOSE (1/2" FITTINGS)	3/4" HOSE (3/4" FITTINGS)
12"	OPT-245	OPT-238	N/A
18"	OPT-246	OPT-239	N/A
24"	OPT-247	OPT-240	N/A
36"	OPT-248	OPT-241	OPT-248HC
48"	OPT-249	OPT-242	N/A



Gas Key Valves

Includes Key Valve, Valve Cover & Key

ITEM	CHROME	GOLD	ANTIQUE	BLACK
1/2" Standard Key Valve	OPT-256	OPT-256GO	OPT-256AN	OPT-256BL
1/2" Ball Valve	OPT-256FF	OPT-256FFGO	OPT-256FFAN	OPT-256FFBL
3/4" Ball Valve	OPT-25634	OPT-25634GGO	OPT-25634 AN	OPT-25634BL
1/2" Ball Valve 90° Bend	OPT-259FF	OPT-259FFGO	OPT-259FFAN	OPT-259FFBL
3/4" Ball Valve 90° Bend	OPT-35690	OPT-35690GO	OPT-35690AN	OPT-35690BL

Looking to add some flare to your fireplace? See T.O.P's ornaments & sculpture collection on the next page

Custom Stainless Steel Sculpture

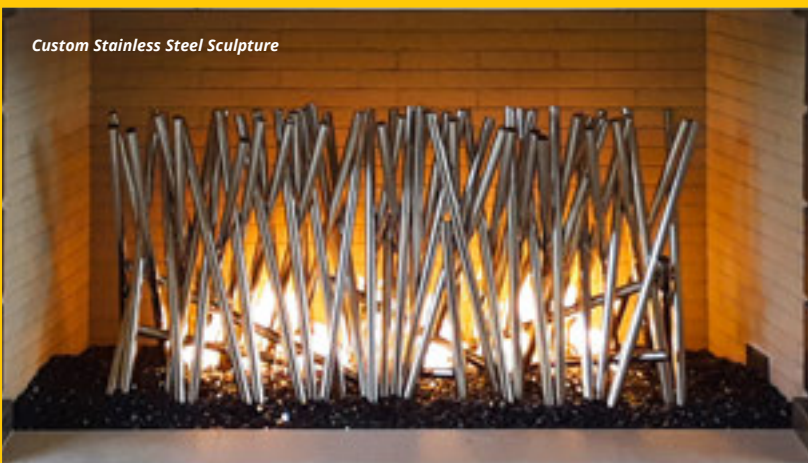

Custom 48" Stainless Steel Tangled Fireplace Burner

FIREPLACE SCREENS

Out fireplace screens are more than just utilitarian. Make a statement with one of T.O.P.'s specially designed screens

Rigid steel frame, laser cut designs back with mesh.
Full steel construction & powder coated finish.

The screen stands on two legs pointed forward
Each screen can be made to fit any custom size if needed.

MODEL	PART #	WIDTH	HEIGHT	WEIGHT
Deer Country	OPT-FPS4030DC	40"	30"	24 lbs.
Twin Lions	OPT-FPS4030TL	40"	30"	24 lbs.
Wetlands	OPT-FPS4030WL	40"	30"	24 lbs.
Gone Fishing	OPT-FPS4030GF	40"	30"	24 lbs.
Big Bear	OPT-FPS4030BB	40"	30"	24 lbs.



Deer Country



Twin Lions



Wetlands



Gone Fishing



Big Bear

ORNAMENTS & SCULPTURES

Our collection of ornaments are a unique way to add personality to any of your fire features. They are suitable for both fire pits and fireplaces and install easily. Some of T.O.P.'s ornaments replace your unit's burner and other ornaments simply sit on top of the burner. As always, we are able to manufacture custom sizes, shapes and even your custom designs!

Black Steel Fireplace Waves

Mild Steel Construction. Replaces pre-existing burner



PART #	DIMENSIONS	HEIGHT	INLET	BTU
OPT-WBB24	24" x 6"	18"	1/2"	80K
OPT-WBB30	30" x 6"	18"	1/2"	100K
OPT-WBB36	36" x 6"	18"	1/2"	120K

Stainless Steel Fireplace Waves

Stainless Steel Construction. Replaces pre-existing burner



PART #	DIMENSIONS	HEIGHT	INLET	BTU
OPT-WBS24	24" x 6"	18"	1/2"	80K
OPT-WBS30	30" x 6"	18"	1/2"	100K
OPT-WBS36	36" x 6"	18"	1/2"	120K

Stainless Steel Tangled Fireplace Burner

Stainless Steel Construction. Replaces pre-existing burner



PART #	DIMENSIONS	HEIGHT	INLET	BTU
OPT-TNG24	24" x 8"	8"	1/2"	80K
OPT-TNG30	30" x 8"	8"	1/2"	100K

ORNAMENTS & SCULPTURES

Fireplace Log And Tray Set

Includes: Steel Logs, Steel Grate, Steel Tray and Burner



PART #	WIDTH	DEPTH	HEIGHT	INLET	BTU
OPT-18SLS	18"	10"	14"	1/2"	90K
OPT-24SLS	24"	10"	14"	1/2"	90K
OPT-30SLS	30"	10"	14"	1/2"	95K
OPT-36SLS	36"	10"	14"	1/2"	100K



Cat Tail Fireplace Burner

Stainless Steel Construction. Replaces pre-existing burner



PART #	WIDTH	DEPTH	HEIGHT	INLET	BTU
OPT-18WRF18	18"	6"	18"	1/2"	90K
OPT-18WRF24	24"	6"	18"	1/2"	90K
OPT-18WRF30	30"	6"	18"	1/2"	95K
OPT-18WRF36	36"	6"	18"	1/2"	100K

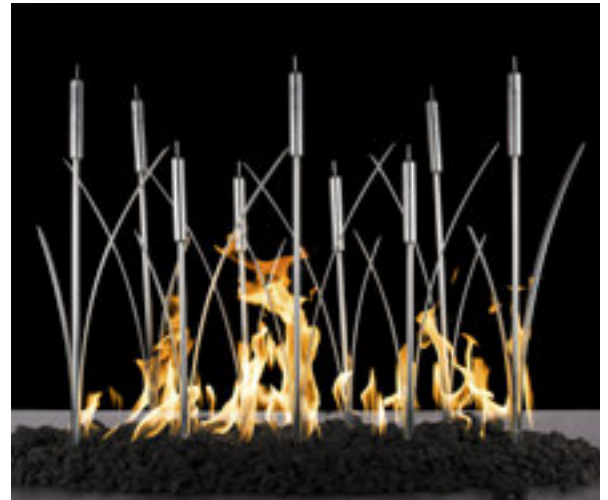

Mild Steel Hoops

Ornament only. Sets over existing burner



PART #	DIMENSIONS	HEIGHT
OPT-STHP24	24" x 16"	18"
OPT-STHP30	30" x 16"	18"



Steel Fire Pit Log Pile

Ornament only. Sets over existing burner.



PART #	DIAMETER	HEIGHT
OPT-1924	19"	24"



Steel Upright Logs

Ornament only. Sets over existing burner. Lava not included.



PART #	DIMENSIONS	HEIGHT
OPT-STLOG24	24" x 10"	18"
OPT-STLOG30	30" x 10"	18"



Steel Fire Balls

Ornament only. Sets over existing burner.
Sold individually.



PART #	DIAMETER	FINISH
OPT-FB4	4"	Steel
OPT-FB6	6"	Steel



ORNAMENTS & SCULPTURES

Gas Burning Bush

Stainless Steel Construction. Male Connection



PART #	DIAMETER	HEIGHT	INLET	BTU
OPT-BB	16"	18"	1/2"	65k



Gas Fire Tree Burner

Stainless Steel Construction. Male Connection



PART #	WIDTH	HEIGHT	INLET	BTU
OPT-3000	24"	24"	1/2"	180k



Gas Lotus Flower Burner

Stainless Steel Construction. Male Connection



PART #	DIAMETER	HEIGHT	INLET	BTU
OPT-LF	18"	9"	1/2"	65k



Gas Fire Globe Burner

Stainless Steel Construction. Male Connection



PART #	DIAMETER	HEIGHT	INLET	BTU
OPT-FG12	12"	12"	1/2"	75K
OPT-FG18	18"	18"	1/2"	125K
OPT-FG24	24"	24"	1/2"	175K



Bird's Nest

Includes Ornament & SS Burner



Mild Steel



Stainless Steel



PART #	DIAMETER	HEIGHT	BURNER	INLET	BTU
MILD STEEL					
OPT-30BNS	30"	18"	24"	1/2"	150K
OPT-36BNS	36"	18"	24"	1/2"	150K
OPT-48BNS	48"	18"	36"	3/4"	200K
STAINLESS STEEL					
OPT-30BN	30"	18"	24"	1/2"	150K
OPT-36BN	36"	18"	24"	1/2"	150K
OPT-48BN	48"	18"	36"	3/4"	200K

1/2" Mild Steel Desert Sticks

Ornament only. Sets over existing burner



PART #	DIAMETER	HEIGHT
OPT-DS	20"	24"



1/2" Solid Steel Logs

Ornament only. Sets over existing burner



PART #	DIAMETER	HEIGHT
OPT-SL	18"	20"



ORNAMENTS & SCULPTURES

Steel Triangle Sculpture

Ornament only. Sets over existing burner



PART #	DIMENSIONS	HEIGHT
OPT-STTRI24	24" x 14"	22"
OPT-STTRI30	30" x 14"	22"



Stainless Steel Polished Logs

Ornament only. Sets over existing burner



PART #	DIMENSIONS	HEIGHT
OPT-CS2410	24" x 10"	18"
OPT-CS3010	30" x 10"	18"



1/4" Milled Steel Fire Twigs

Ornament only. Sets over existing burner



PART #	DIMENSIONS	HEIGHT
OPT-STWG24	24" x 10"	18"
OPT-STWG30	30" x 10"	18"



SMART WEATHER ELECTRONIC IGNITION SYSTEM (SWEIS)

The Smart Weather Electronic Ignition System (SWEIS) is an automated ignition system for any fire pit and fire bowl. We offer 3 different output options to make sure you have the right unit for your fire feature, regardless of the size. The SWEIS is offered in either 12V or 110V Plug & Play options to accommodate different kind of installations. . Each unit comes with a 1 Year Limited Warranty

Works with LP or NG

TOP's Smart Weather Electronic Ignition System is compatible with both Natural Gas and Liquid Propane (Portable LP Tank or Hard Line LP are both okay!)

Safety is T.O.P.'s Goal

The SWEIS is tested to withstand winds up to 55mph. If the flame is blown out, the unit will automatically reignite. The unit will shut off automatically in unsafe, severe rain & wind conditions.

Weather Tested

Proven to operate properly in mild wind, rain & snow.

Compact Construction

The small construction allows it to be installed in tight spaces.

1 Year Limited Warranty

Covers all components of the Electronic Ignition System

12 Volts or 110 Volts

Different types of electricity for different kinds of applications. 12V is required for installations near pools, spas & other bodies of water

110V Plug & Play System

The three prong plug speeds up installation and only requires an weather protected GFCI socket with a light switch

Functions with:

On/Off Switches, Remote Control, Pool Remote, Smart Home System, Electric Timers and Emergency Stop Buttons

12V Smart Weather Electronic Ignition System

When you order any of T.O.P.'s 12V SWEIS kits, you will receive an Electronic Valve, a Pilot Igniter, and a 12V-14V Transformer.

Our pilots use an hot surface igniter (HSI) for pilot ignition and a thermocouple flame sensor to ensure the feature is lit properly and stops gas flow if the flame is ever blown out. The electronic valve is rated for temperatures between -20°F - 175°F (-28°C - 80°C). The valve enclosure includes an LED diagnostic light to indicate proper operation and to help ease trouble shooting.



12V Mini Capacity System

TOP-500EIS-100-12

- » Maximum Gas Output: 190K BTU/hr
- » Inlet Gas Pressure Limit: ½ PSI
- » Inlet / Outlet Size: ½" FIP
- » Electrical Rating: 12VAC
- » L: 4.75" W: 4" H: 4"



12V Standard Capacity System

TOP-500EIS-200-12

- » Maximum Gas Output: 290K BTU/hr
- » Inlet Gas Pressure Limit: ½ PSI
- » Inlet / Outlet Size: ½" FIP
- » Electrical Rating: 12VAC
- » L: 5.5" W: 4" H: 4"



12V High Capacity System

TOP-500EIS-300-12

- » Maximum Gas Output: 510K BTU/hr
- » Inlet Gas Pressure Limit: ½ PSI
- » Inlet / Outlet Size: ¾" FIP
- » Electrical Rating: 12VACI
- » L: 6" W: 5" H: 5"

110V Plug & Play Smart Weather Electronic Ignition System

When you order any of T.O.P.'s 110V SWEIS kits, you will receive an Electronic Valve with a 3-Prong Plug and a Pilot Igniter

Our pilots use an hot surface igniter (HSI) for pilot ignition and a thermocouple flame sensor to ensure the feature is lit properly and stops gas flow if the flame is ever blown out. The electronic valve is rated for temperatures between -20°F - 175°F (-28°C - 80°C). The valve enclosure includes an LED diagnostic light to indicate proper operation and to help ease trouble shooting.



110V Mini Capacity System

TOP-500EIS-100-110

- » Max Gas Output: 190K BTU/hr
- » Max Inlet Gas Pressure: ½ PSI
- » Inlet / Outlet Size: ½" FIP
- » Electrical Rating: 110VAC
- » L: 5.5" W: 7" H: 3"



110V Standard Capacity System

TOP-500EIS-200-110

- » Max Gas Output: 290K BTU/hr
- » Max Inlet Gas Pressure: ½ PSI
- » Inlet / Outlet Size: ½" FIP
- » Electrical Rating: 110VAC
- » L: 5.75" W: 7" H: 3.75"



110V High Capacity System

TOP-500EIS-300-110

- » Max Gas Output: 510K BTU/hr
- » Max Inlet Gas Pressure: ½ PSI
- » Inlet / Outlet Size: ¾" FIP
- » Electrical Rating: 110VAC
- » L: 6" W: 7.25" H: 3.75"

SWEIS ACCESSORIES & ADD ON'S



Emergency Stop Button

OPT-ESTOP

- » Outdoor Rated Electrical Box And Cover
- » 3x Conduit Entries (½")
- » Suited For 110V Only
- » **Not Compatible With Match Lit Systems**



1-Hour Button Timer

OPT-BTTS

- » Outdoor Rated Electrical Box And Cover
- » 3x Conduit Entries (½")
- » Suited For 110V Only
- » Modes: 10 min., 20 min., 30 min., 60 min., Hold
- » **Not Compatible With Match Lit Systems**



Emergency Stop Button with Key

OPT-ESTOPKEY

- » Outdoor Rated
- » 2X Conduit Entries (½")
- » Includes Two Keys
- » Suited For 110V Only
- » **Not Compatible With Match Lit Systems**



Remote Control & Wireless Receiver

OPT-RC110V

- » Outdoor Rated Box
- » Suited for 110V ONLY
- » Includes Remote & Wireless Receiver
- » **Not Compatible With Match Lit Systems**

Wireless Remote Replacement

OPT-XRM



Electrical Dial Timer

OPT-DTM

- » 1-Hour Timer
- » Outdoor Rated Electrical Box And Cover
- » Suited For 110V Only
- » **Not Compatible With Match Lit Systems**



Weatherproof On/Off Switch

OPT-WPS110V

- » On/Off only
- » Outdoor Rated Electrical Box And Cover
- » Suited For 110V Only
- » **Not Compatible With Match Lit Systems**



Bluetooth Electronic Adapter

TOP-500BLU

- » Provides you with Bluetooth control for all electronic ignition systems
- » Suitable for 12VAC Only
- » Supports iOS and Android
- » Free Smart Phone app available

SWEIS Replacement Components



Pilot Igniter

TOP-500PI

- » Length: 19"
- » Stainless Steel / Brass Construction
- » Hot Surface Igniter (HSI)
- » Thermocouple Flame Sensor
- » Heat/Weather Resistant Sleeve



12V Control Panel

TOP-12VCP

- » 300 Watt
- » Input Voltage: 110/120 VAC
- » Output Voltage: 12/13/14VAC
- » Suitable for Swimming Pools, Spas & Fountains
- » Removable Mounting Brackets
- » Total of 10 Knock Out Locations



Pilot Igniter Extensions

TOP-PIEXT

- » Length: 60"
- » Gas Line Extension
- » Hot Surface Igniter Extension
- » Thermocouple Extension
- » Only for the 12V/110V SWEIS Pilot Igniter



Glow Plug Replacement

TOP-PIGP

- » Only for the 12V/110V SWEIS Pilot Igniter



Pilot Igniter Cover

TOP-PIC

- » 304 Stainless Steel
- » Only for the 12V/110V SWEIS Pilot Igniter



Thermocouple Replacement

TOP-PITC

- » Only for the 12V/110V SWEIS Pilot Igniter



LP Spark Igniter Kit

OPT-2322LP

Includes: Mounting plate, Push Button Igniter, Push Button Electrical Leads, Brass Key Valve, Turn Key, 3/8" SS Whistle Free Hose - 30", LP Regulator, Spark Igniter Cover, LP Air Mix

LP Spark Igniter Kit - High Capacity

OPT-2322LPHC - Applications over 300K BTUs

Includes: Mounting plate, Push Button Igniter, Push Button Electrical Leads, Brass Key Valve, Turn Key, 1/2" SS Whistle Free Hose - 30", LP Regulator, Spark Igniter Cover, LP Air Mix



NG Spark Igniter Kit

OPT-2322NG

Includes: Mounting Plate, Push Button Igniter, Push Button Electrical Leads, Brass Key Valve, Turn Key, 3/8" 1/2" SS Whistle Free Hoses (2x), Spark Igniter Cover, NG Orifice

NG Spark Igniter Kit - High Capacity

OPT-2322NGHC - Applications over 300K BTUs

Includes: Mounting Plate, Push Button Igniter, Push Button Electrical Leads, Brass Key Valve, Turn Key, 3/8" 1/2" SS Whistle Free Hoses (2x), Spark Igniter Cover, NG Orifice



Spark Igniter Kit - Push Button & 36" Electrode

OPT-SIPB



Push Button Only

OPT-RPB



Electrode - 36" Leads

OPT-P36



Electrode Cover

OPT-PIC

Spark Igniter Diagram

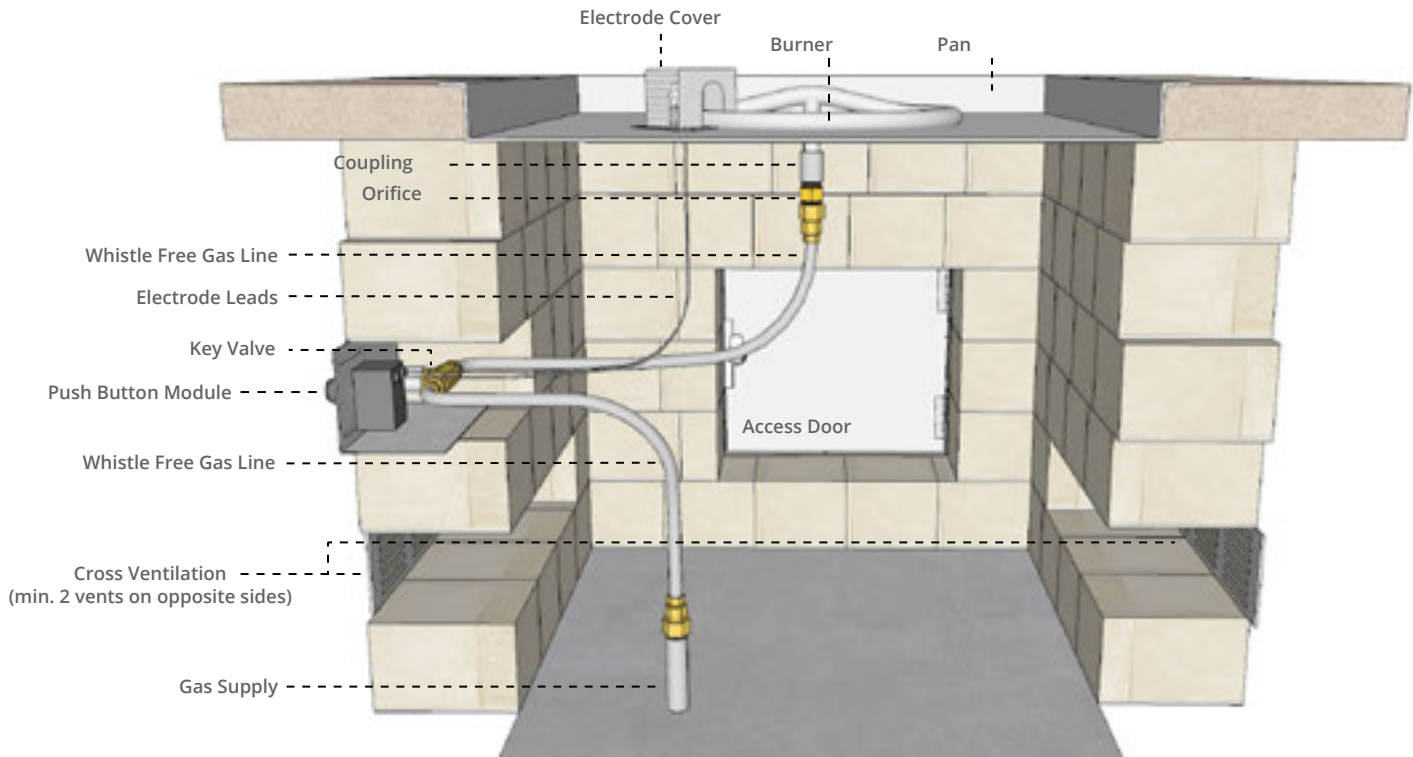

FLAME SENSE VALVE KITS



Flame Sense Valve

TOP-FSML

- » Includes: Flame Sense Valve, Heat Sensor
- » W: 7-5/8" H: 3" D: 7"
- » 30" Leads
- » Must be installed in a cavity that is at least 10" deep to accommodate the gas lines that will be connected
- » CSA Certified



Flame Sense Valve - LP

TOP-FSML-LP

- » Includes: Flame Sense Valve, Heat Sensor, (1x) 6ft LP Regulator, (1x) SS Whistle Free Hose, LP Air Mixing Orifice
- » W: 7-5/8" H: 3" D: 7"
- » 30" Leads
- » Must be installed in cavity that is at least 10" deep to accommodate gas connections
- » CSA Certified



Flame Sense Valve - NG

TOP-FSML-NG

- » Includes: Flame Sense Valve, Heat Sensor, (2x) SS Whistle Free Hose, NG Orifice
- » W: 7-5/8" H: 3" D: 7"
- » 30" Leads
- » Must be installed in a cavity that is at least 10" deep to accommodate gas connections
- » CSA Certified



Flame Sense with Spark Igniter

TOP-FSPBI

- » Includes: Flame Sense Valve, Push Button Spark Igniter
- » W: 7-5/8" H: 3" D: 7"
- » 30" Leads
- » Must be installed in a cavity that is at least 10" deep to accommodate the gas lines that will be connected



Flame Sense with Spark Igniter (Liquid Propane)

TOP-FSPBI-LP

- » Includes: Flame Sense Valve with Push Button Spark Igniter, (1x) SS Whistle Free Hose, (1x) 6ft LP Regulator, LP Air Mixing Orifice
- » W: 7-5/8" H: 3" D: 8"
- » 30" Leads
- » Must be installed in a cavity that is at least 10" deep to accommodate the gas lines that will be connected



Flame Sense with Spark Igniter (Natural Gas)

TOP-FSPBI-NG

- » Includes: Flame Sense Valve with Push Button Spark Igniter, (2x) SS Whistle Free Hose, NG Orifice
- » W: 7-5/8" H: 3" D: 8"
- » 30" Leads
- » Must be installed in a cavity that is at least 10" deep to accommodate the gas lines that will be connected

Flame Sense Replacement Components



Flame Sense Valve
OPT-FSGV



Flame Sense Pilot
OPT-FSPL-LP
OPT-FSPL-NG



On/Off Knob Cover
OPT-FSOC



Pilot Hood
OPT-FSPG



Thermocouple
OPT-FSTC



NG Orifice 39
OPT-FSNGO



Propane Orifice 23
OPT-FSLPO



Adjustable Paver Bracket

Height: 3.875" ; Width: Min - 8" ; Max - 14" ; Depth: 4"

Natural Gas Paver Bracket & Gas Kit

OPT-PB256NG

Includes: Adjustable SS Bracket, Key Valve, Turn Key, 24" Whistle Free Hoses (2x), NG Orifice

Natural Gas Paver Bracket & Gas Kit - Hi-Cap

OPT-PB256NGHC

Includes: Adjustable SS Bracket, Full Flow Key Valve, Turn Key, 24" Whistle Free Hoses (2x), NG Orifice

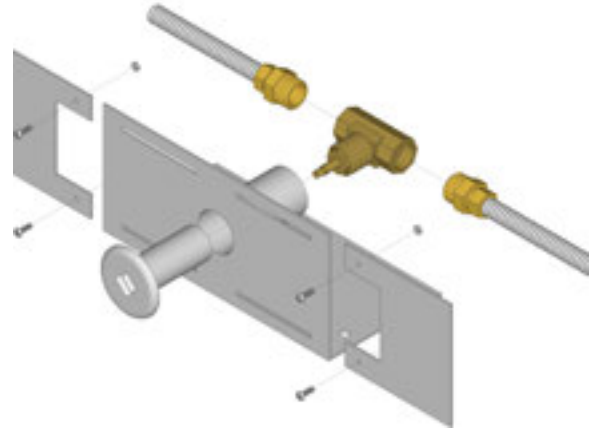

Liquid Propane Paver Bracket & Gas Kit

OPT-PB256LP

Includes: Adjustable SS Bracket, Key Valve, Turn Key, 24" Whistle Free Hose, LP Regulator, LP Air Mix Orifice

Liquid Propane Paver Bracket & Gas Kit - Hi-Cap

OPT-PB256LPHC

Includes: Adjustable SS Bracket, Full Flow Key Valve, Turn Key, 24" Whistle Free Hose, LP Regulator, LP Air Mix Orifice

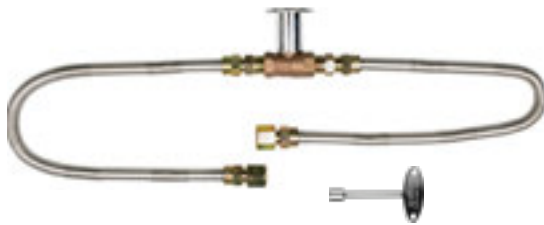

Gas Kits

Natural Gas Kit - Up to 290K BTUS

OPT-NGKNG

Includes: Key Valve, Turn Key, 24" Whistle Free Hoses (2x), Natural Gas Orifice

Natural Gas Kit - High Capacity - 300k+ BTUs

OPT-NGKNGHC

Includes: Full Flow Key Valve, Turn Key, 24" Whistle Free Hoses (2x), Natural Gas Orifice



Liquid Propane Gas Kit - Up to 290K BTUS

OPT-LPKLP

Includes: Key Valve, Turn Key, 24" Whistle Free Hose, LP Regulator, LP Air Mix Orifice

Liquid Propane Gas Kit - Up to 290K BTUS

OPT-LPKLPHC

Includes: Key Valve, Turn Key, 24" Whistle Free Hose, LP Regulator, LP Air Mix Orifice

Gas Conversion Kits



Natural Gas to Liquid Propane Conversion Kit

OPT-LPCKIT

Includes: LP Air Mixing Orifice, Coupling, Propane Regulator with Hose



Liquid Propane to Natural Gas Conversion Kit

OPT-NGCKIT

Includes: Natural Gas Orifice, Coupling, 1/2" Whistle Free Hose

GAS KITS, HOSES AND ACCESSORIES



	Chrome	Gold	Antique	Black
1/2" Standard Key Valve	OPT-256	OPT-256GO	OPT-256AN	OPT-256BL
1/2" Ball Valve	OPT-256FF	OPT-256FFGO	OPT-256FFAN	OPT-256FFBL
3/4" Ball Valve	OPT-25634	OPT-25634GGO	OPT-25634 AN	OPT-25634BL
1/2" Ball Valve 90° Bend	OPT-259FF	OPT-259FFGO	OPT-259FFAN	OPT-259FFBL
3/4" Ball Valve 90° Bend	OPT-35690	OPT-35690GO	OPT-35690AN	OPT-35690BL



Stainless Steel Whistle Free Hose

Includes: Hose, Flare to Non-Flared Fittings. Max 1/2 PSI

Length	3/8" Hose (1/2" Fittings)	1/2" Hose (1/2" Fittings)	3/4" Hose (3/4" Fittings)
12"	OPT-245	OPT-238	N/A
18"	OPT-246	OPT-239	N/A
24"	OPT-247	OPT-240	N/A
36"	OPT-248	OPT-241	OPT-248HC
48"	OPT-249	OPT-242	N/A



LP Regulator - 48"

OPT-1300
 » 36" Hose
 » 3/8" Flared Fitting



LP Regulator - 96"

OPT-130096
 » 96" Hose
 » 5/8" Flared Fitting



High Pressure LP Hose - 8'

OPT-1321HP
 » 72" Hose
 » 3/8" Flared Fitting



Quick Connect Gas Hose

3/8" Hose OPT-QCHOSE	1/2" Hose OPT-QCHOSEHC
» For Propane	» For Natural Gas
» Length: 8 ft.	» Length: 8 ft.
» 3/8" Flared	» 1/2" Flared
» 1/2" NPT	» 3/4" NPT



Turn Key for Gas Key Valves

4" Key	OPT-RKV
8" Key	OPT-RKV8
11" Key	OPT-RKV11
16" Key	OPT-RKV16
22" Key	OPT-RKV22



Gas Timer & E-Stop

OPT-ESTOPTM
 » 1-Hour Max
 » Outdoor Rated
 » 4x Gas Entries (1/2" NPT)
 » **W:** 2-7/8" **H:** 4" **D:** 2-1/2"



Gas Timer & E-Stop With Recessed Panel

OPT-ESTOPTMPL
 » 1-Hour Max
 » Outdoor Rated
 » 4X Gas Entries (1/2")
 » Includes 2x 90° Elbows



Gas Ball Valve

OPT-NGBV
 » 1/2" NPT
 » Ball Valve



Natural Gas Regulator

OPT-1300NGR
 » 1/2" Inlet
 » Max 1/2 PSI

Gas Fittings



	Description	Part #
1	3/8" Flared Male x 1/2" Male	OPT-23B
1	1/2" Flared Male x 1/2" Male	OPT-232
1	3/4" Flared Male x 3/4" Male	OPT-23234
2	3/8" Flared Male x 1/2 Female	OPT-23CC
2	1/2" Flared Male x 1/2 Female	OPT-231
2	3/4" Flared Male x 3/4 Female	OPT-23134
3	1/2" Liquid Propane Air Mix	OPT-232A
4	3/4" Liquid Propane Air Mix	OPT-232AHC
5	1/2" Natural Gas Orifice	OPT-NG012

	Description	Part #
5	3/4" Natural Gas Orifice	OPT-NG012HC
6	90° 3/8" Male x 1/2" Female	OPT-903812
7	1/2" Coupling	OPT-SSNC
7	3/4" Coupling	OPT-SSNC34
8	1/2" 90° Elbow	OPT-SSN90
8	3/4" 90° Elbow	OPT-SSN9034
9	1/2" 'T' Joint	OPT-SSNT
9	3/4" 'T' Joint	OPT-SSNT34
10	1/2" Union	OPT-SSUN

	Description	Part #
10	3/4" Union	OPT-SSUN34
11	1/2" Street Elbow 90°	OPT-SSSEB
12	3/4" To 1/2" Bell Fitting	OPT-SS2TO3
13	1/2" Closed Nipple	OPT-SSN
13	1/2" 3" Long Nipple	OPT-SSN3
13	1/2" 6" Long Nipple	OPT-SSN6
13	3/4" Closed Nipple	OPT-SSN34
13	3/4" 3" Long Nipple	OPT-SSN334
13	3/4" 6" Long Nipple	OPT-SSN634

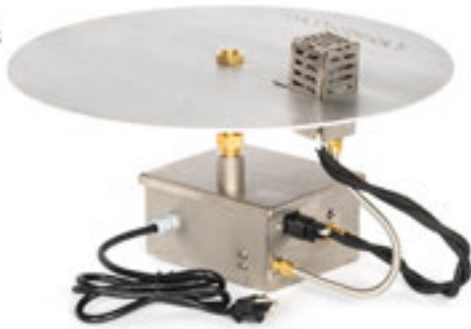

110V Electronic Ignition System Add-On

Add "-EKIT" To The End Of The Fire Pit SKU

- » **Includes:** SWEIS Electronic Valve with 3-prong Power Cord, Pilot Igniter
- » Electronic Ignition Kit Installed Onto Any Fire Pit Of Your Choice
- » Add-on ONLY
- » Includes the cost of the components and installation.
- » 110V Option for plug & play applications
- » Not suitable for installation within 5ft of water.
- » Pan shown as example only - Will use pan that is included with the fire pit



12V Electronic Ignition System Add-On

Add "-E12V" To The End Of The Fire Pit SKU

- » **Includes:** SWEIS Electronic Valve, Pilot Igniter, 12v-14v Transformer
- » Electronic Ignition Kit Installed Onto Any Fire Pit Of Your Choice
- » Add-on ONLY
- » Includes the cost of the components and installation.
- » Must be installed by a certified professional.
- » Pan shown as example only - Will use pan that is included with the fire pit



Flame Sense with Spark Igniter Add-On

Add "-FSEN" To The End Of The Fire Pit SKU

- » **Includes:** Stainless Steel Panel, Key Valve, Key, Push Button Igniter, Electrode
- » Stainless Steel panel installed onto the side of any fire pit of your choice.
- » No Assembly Required
- » Add-on ONLY, cannot be bought separately.
- » Requires 1 AA Battery

Can be stacked with the Gas Timer w/ Emergency Stop
"-GTESP"



Flame Sense with Match Lit Add-On

Add "-FSML" To The End Of The Fire Pit SKU

- » **Includes:** Flame Sense System, Manual Gas Valve, Flame Sensor,
- » Stainless Steel panel installed onto the side of any fire pit of your choice.
- » No Assembly Required
- » Add-on ONLY, cannot be bought separately.
- » No Batteries or Electricity Required

Can be stacked with the Gas Timer w/ Emergency Stop
"-GTESP"



Dial Timer Panel Add-On

Add "-DTMP" To The End Of The Fire Pit SKU

- » **NOT Compatible With Match Lit Units**
- » **Includes:** Dial Timer (110V), Key Valve, Key, Panel
- » Stainless Steel panel installed onto any fire pit of your choice.
- » No Assembly Required
- » Add-on ONLY, cannot be bought separately.
- » Fire Pit MUST Have Electronic Ignition



Gas Timer w/ Emergency Stop Panel Add-On

Add "-GTESP" To The End Of The Fire Pit SKU

- » **Includes:** Stainless Steel Panel, Key Valve, Key, Gas Timer w/ Emergency Stop
- » Stainless Steel panel installed onto the side of any fire pit of your choice.
- » No Assembly Required
- » Add-on ONLY, cannot be bought separately.
- » Battery Powered



Spark Igniter Panel Add-On

Add "-PBSIP" To The End Of The Fire Pit SKU

- » **Includes:** Stainless Steel Panel, Key Valve, Key, Push Button Igniter, Electrode,
- » Stainless Steel panel installed onto the side of any fire pit of your choice.
- » No Assembly Required
- » Add-on ONLY, cannot be bought separately.
- » Battery Powered

Can be stacked with the Gas Timer w/ Emergency Stop "-GTESP"



Gas Timer w/ Emergency Stop
"-GTESP"

Flame Sense with Spark Igniter Add-On
"-FSEN"



Glass comes in 25lb bags. Lava chunks come in 1 cubic foot quantity. Polished lava comes in 1/2 cubic foot quantity.
 All options are suitable for any type of fire. We suggest covering the burner a maximum of 1 inch.



How Much Glass Does My Fire Pit Need?

Use this table to decide how much glass you will need for your fire feature's burning area. These amounts are for units with a burning area depth of about 2".

Rectangular Burn Area

LENGTH	WIDTH	GLASS	LENGTH	WIDTH	GLASS	LENGTH	WIDTH	GLASS	LENGTH	WIDTH	GLASS
24"	6"	17 lbs.	24"	8"	20 lbs.	24"	12"	34 lbs.	24"	18"	45 lbs.
30"	6"	21 lbs.	30"	8"	25 lbs.	30"	12"	42 lbs.	30"	18"	56 lbs.
36"	6"	25 lbs.	36"	8"	30 lbs.	36"	12"	50 lbs.	36"	18"	67 lbs.
42"	6"	29 lbs.	42"	8"	35 lbs.	42"	12"	58 lbs.	42"	18"	79 lbs.
48"	6"	34 lbs.	48"	8"	40 lbs.	48"	12"	68 lbs.	48"	18"	90 lbs.
60"	6"	42 lbs.	60"	8"	50 lbs.	60"	12"	84 lbs.	60"	18"	112 lbs.
72"	6"	50 lbs.	72"	8"	60 lbs.	72"	12"	100 lbs.	72"	18"	135 lbs.
84"	6"	59 lbs.	84"	8"	70 lbs.	84"	12"	118 lbs.	84"	18"	157 lbs.
96"	6"	67 lbs.	96"	8"	80 lbs.	96"	12"	134 lbs.	96"	18"	180 lbs.

Round Burn Area

DIAMETER	GLASS
13"	15 lbs.
19"	30 lbs.
25"	50 lbs.
31"	80 lbs.
37"	125 lbs.
48"	192 lbs.
60"	300 lbs.

Square Burn Area

SIZE	GLASS
16.5"	15 lbs.
18"	30 lbs.
24"	50 lbs.
30"	80 lbs.
36"	125 lbs.
48"	240 lbs.
60"	375 lbs.

FIRE PIT ADD ONS

Fire Pit Lids

Fire Pit Covers will protect your fire pit year round from the harsh elements. The covers also create a table top for when the fire pit is not in use for extra food & drink space. *Note: All Fire Pit Lids are flat.*

Square Cover

304 Stainless Steel, Brushed Finish



DIMENSION	PART #
16" x 16"	OPT-16SC
22" x 22"	OPT-22SC
28" x 28"	OPT-28SC
34" x 34"	OPT-34SC
40" x 40"	OPT-40SC
46" x 46"	OPT-46SC

Rectangular Cover

304 Stainless Steel, Brushed Finish



DIMENSION	PART #
28" x 10"	OPT-RC1028
40" x 10"	OPT-RC1040
52" x 10"	OPT-RC1052
64" x 10"	OPT-RC1064
76" x 10"	OPT-RC1076
88" x 10"	OPT-RC1088
28" x 16"	OPT-RC1628
40" x 16"	OPT-RC1640
52" x 16"	OPT-RC1652
64" x 16"	OPT-RC1664
76" x 16"	OPT-RC1676
88" x 16"	OPT-RC1688



Round Cover

304 Stainless Steel, Brushed Finish



DIAMETER	PART #
17"	OPT-17RC
23"	OPT-23RC
29"	OPT-29RC
35"	OPT-35RC
41"	OPT-41RC
47"	OPT-47RC

Cone Cover

Aluminum, Black Powder Coat Finish



DIAMETER	HEIGHT	PART #
17"	3"	OPT-RCB17
23"	3"	OPT-RCB23
29"	4"	OPT-RCB29
35"	5"	OPT-RCB35
41"	6"	OPT-RCB41
47"	7"	OPT-RCB47

Black Cone Cover & Heat Reflector

Includes: Hook with Mounting Bracket and Black Cone Cover

PART #	DIAMETER	HEIGHT
OPT-RCB17HRF	17"	48"
OPT-RCB23HRF	23"	48"
OPT-RCB29HRF	29"	48"
OPT-RCB35HRF	35"	48"
OPT-RCB41HRF	41"	48"
OPT-RCB47HRF	47"	48"



Stainless Steel Access Doors

Access Doors come equipped with a lock latch. Key Included. Brushed Finish.

PART #	DOOR DIMENSIONS	OUTSIDE DIMENSION	DEPTH
OPT-ADSS88	8" x 8"	10" x 10"	1.5"
OPT-ADSS1010	10" x 10"	12" x 12"	1.5"
OPT-ADSS1212	12" x 12"	14" x 14"	1.5"
OPT-ADSS1417	14" x 17"	16" x 19"	1.5"

FIRE PIT ADD ONS

Glass Wind Guards

Glass Wind Guards provide protection where extra caution is necessary and preserve flames in windy conditions. They are intended to be placed on top of the fire pit, not inside.



What Size Should My Wind Guard Be?

The Ideal size of a wind guard should be the size of your burning area **plus 2 inches on each side**. This allows you to still use a steel cover when the unit is not in use & reduces soot build up on the glass.

Ex: 24" x 24" burning area should use a 28" x 28" Glass Wind Guard.

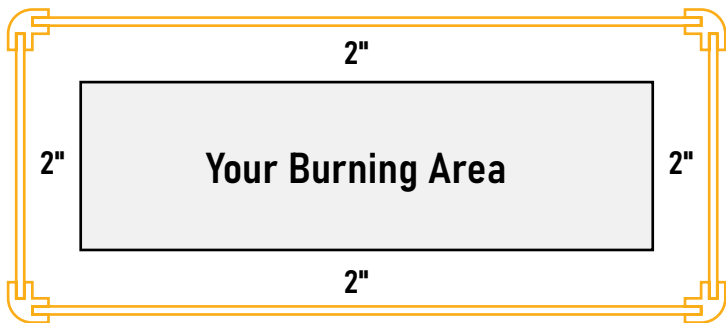

Rectangular Wind Guard

BURN AREA →	WIND GUARD SIZE	PART #
24" x 8"	28" x 13" x 8"	OPT-WG-2813
30" x 8"	34" x 13" x 8"	OPT-WG-3413
36" x 8"	40" x 13" x 8"	OPT-WG-4013
42" x 8"	46" x 13" x 8"	OPT-WG-4613
48" x 8"	52" x 13" x 8"	OPT-WG-5213
60" x 8"	64" x 13" x 8"	OPT-WG-6413
72" x 8"	76" x 13" x 8"	OPT-WG-7613
24" x 12"	28" x 16" x 8"	OPT-WG-2816
30" x 12"	34" x 16" x 8"	OPT-WG-3416
36" x 12"	40" x 16" x 8"	OPT-WG-4016
42" x 12"	46" x 16" x 8"	OPT-WG-4616
48" x 12"	52" x 16" x 8"	OPT-WG-5216
60" x 12"	64" x 16" x 8"	OPT-WG-6416
72" x 12"	76" x 16" x 8"	OPT-WG-7616
24" x 18"	28" x 22" x 8"	OPT-WG-2822
30" x 18"	34" x 22" x 8"	OPT-WG-3422
36" x 18"	40" x 22" x 8"	OPT-WG-4022
42" x 18"	46" x 22" x 8"	OPT-WG-4622
48" x 18"	52" x 22" x 8"	OPT-WG-5222
60" x 18"	64" x 22" x 8"	OPT-WG-6422
72" x 18"	76" x 22" x 8"	OPT-WG-7622

Square Wind Guard

BURN AREA →	WIND GUARD SIZE	PART #
12" x 12"	14" x 14" x 8"	OPT-WG-1414
18" x 18"	22" x 22" x 8"	OPT-WG-2222
24" x 24"	26" x 26" x 8"	OPT-WG-2626
30" x 30"	32" x 32" x 8"	OPT-WG-3232
36" x 36"	38" x 38" x 8"	OPT-WG-3838
42" x 42"	44" x 44" x 8"	OPT-WG-4444
48" x 48"	50" x 50" x 8"	OPT-WG-5050



Stainless Steel Flame Guard

The Stainless Steel Flame Guards are all custom and made to order. The perforated material blocks any unwanted debris as well. We can make them in any size & any shape to fit any new or pre-existing fire feature. Email or call today to inquire.

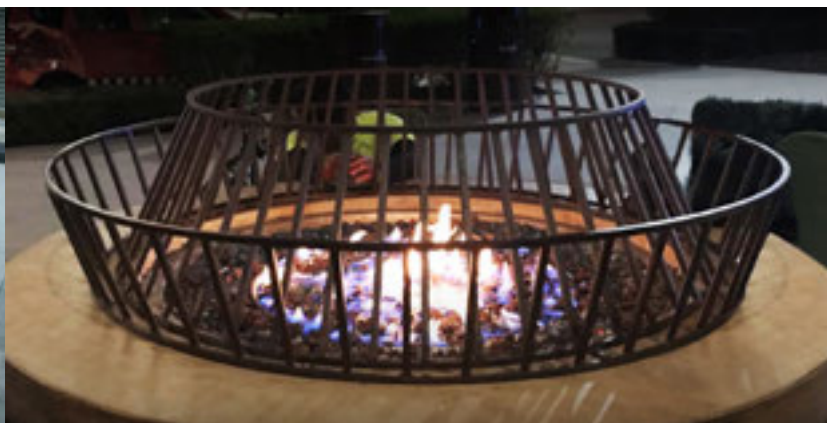

Mild Steel Flame Guard

Mild Steel Flame Guards are all custom and made to order. We can make them in any size & any shape to fit any new or pre-existing fire feature. Email or call today to inquire.

FIRE PIT ADD ONS

Fire Pit & Bowl Canvas Covers

Make sure your fire pit is protected from the elements by acquiring a durable and long-lasting canvas cover. These covers are tougher and more resistant than traditional canvas covers. Canvas Cover include a draw string for a snug and secure fit

Rectangular Fire Pit Covers

DIMENSION	PART #
36" x 24"	OPT-CVR-3624
46" x 22"	OPT-CVR-4622
48" x 10"	OPT-CVR-4810
48" x 24"	OPT-CVR-4824
48" x 28"	OPT-CVR-4828
48" x 30"	OPT-CVR-4830
48" x 36"	OPT-CVR-4836
48" x 48"	OPT-CVR-4848
50" x 50"	OPT-CVR-5050
54" x 24"	OPT-CVR-5424
56" x 38"	OPT-CVR-5638
60" x 10"	OPT-CVR-6010
60" x 24"	OPT-CVR-6024
60" x 28"	OPT-CVR-6028
60" x 36"	OPT-CVR-6036
66" x 38"	OPT-CVR-6638
72" x 10"	OPT-CVR-7210
72" x 16"	OPT-CVR-7216
72" x 28"	OPT-CVR-7228
72" x 36"	OPT-CVR-7236
78" x 36"	OPT-CVR-7836
84" x 28"	OPT-CVR-8428
84" x 36"	OPT-CVR-8436
90" x 38"	OPT-CVR-9038
96" x 28"	OPT-CVR-9628
108" x 28"	OPT-CVR-10828
120" x 28"	OPT-CVR-12028
120" x 48"	OPT-CVR-12048
120" x 60"	OPT-CVR-12060
144" x 48"	OPT-CVR-14448
144" x 60"	OPT-CVR-14460

Square Fire Pit Covers

DIMENSION	PART #
20" x 20"	OPT-CVR-2020
24" x 24"	OPT-CVR-2424
30" x 30"	OPT-CVR-3030
36" x 36"	OPT-CVR-3636
42" x 42"	OPT-CVR-4242
48" x 48"	OPT-CVR-4848
50" x 50"	OPT-CVR-5050
60" x 60"	OPT-CVR-6060

Round Fire Pit Covers

DIAMETER	PART #
22" Round	OPT-CVR-22R
30" Round	OPT-CVR-30R
32" Round	OPT-CVR-32R
36" Round	OPT-CVR-36R
38" Round	OPT-CVR-38R
42" Round	OPT-CVR-42R
43" Round	OPT-CVR-43R
48" Round	OPT-CVR-48R
54" Round	OPT-CVR-54R
60" Round	OPT-CVR-60R
72" Round	OPT-CVR-72R



EVERY COVER IS TIGHTENED WITH A DRAW STRING AND SECURED WITH A TOGGLE SPRING CLASP.

Bowl Covers

DIMENSION	PART #
24" Round	OPT-BCVR-24R
27" Round	OPT-BCVR-27R
30" Round	OPT-BCVR-30R
31" Round	OPT-BCVR-31R
32" Round	OPT-BCVR-32R
33" Round	OPT-BCVR-33R
36" Round	OPT-BCVR-36R
37" Round	OPT-BCVR-37R
38" Round	OPT-BCVR-38R
24" Square	OPT-BCVR-2424
30" Square	OPT-BCVR-3030
36" Square	OPT-BCVR-3636

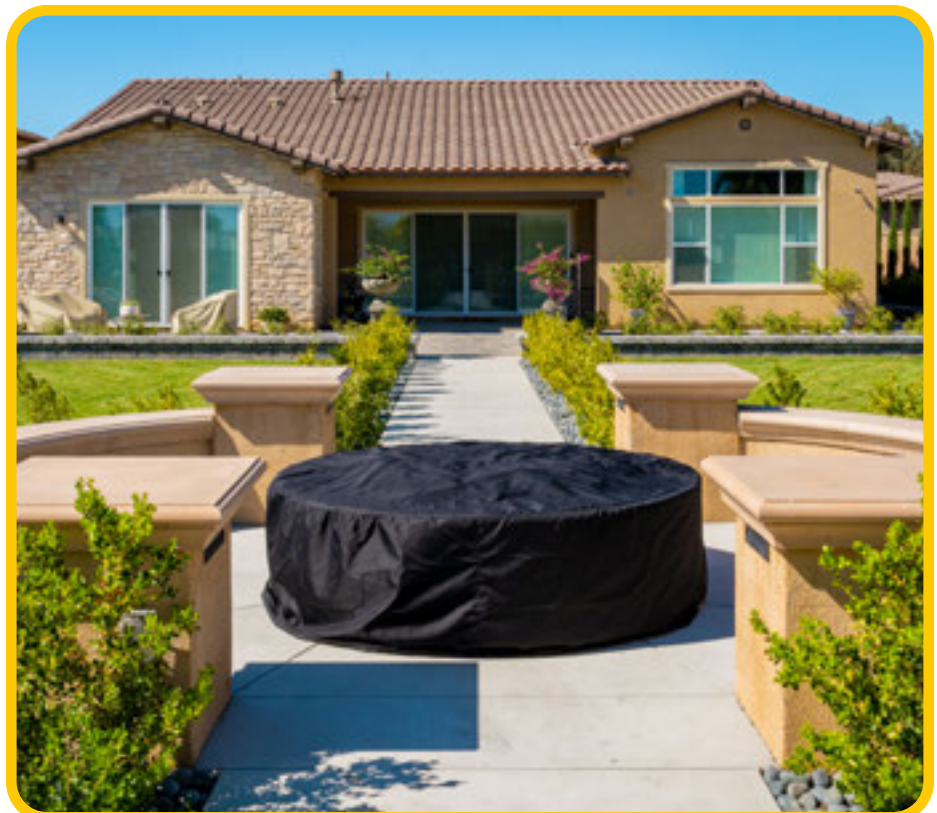

The Outdoor Plus prides itself in manufacturing everything you see here. With a fully operational manufacturing facility, we are able to custom make practically any fire pit, fire tower, scuppers, pans, burners and more. Whether its a fire pit that needs a few inches adjusted or a completely original product, the possibilities are endless. T.O.P's experienced staff and array of machinery can manufacture what you truly desire.

To inquire, send an email to sales@theoutdoorplus.com or go to theoutdoorplus.com/custom



Custom Fire Tower



Custom Arched Pan & Linear Burner



Custom 18' Self Contained Fire & Water Unit



Custom 4' Water & Planter Feature



Custom Fire & Water Feature



Custom Guitar Fire Pit with Musical Cut-Out Details



Custom 18" x 60" Desert Sticks



Custom Fire Pit & Custom Tile Finish



Custom Size Unity Fire Pit



Custom Stainless Steel Tower



Custom Drop In Pan & Burner



Custom Copper Scupper



Custom Curved Burner

PRODUCT WARRANTY

The Outdoor Plus Company (TOP) warranties fire pits against manufacturing defects that prevent safe and correct function as follows:

Warranty periods are as follows:

Electronics, Gas Valves, & Pilot Assembly:

Commercial - 6 Months ; Residential - 1 Year

Stainless Steel & Aluminum Pans:

Commercial - 1 year; Residential - 3 years

Burner Ring & Burner Bars:

Lifetime Warranty

Electrodes & Spark Igniters

Not Warrantied (due to lifespan)

- This commences from the date of original sale / shipment from The Outdoor Plus
- The warranty on parts and in-house labor will apply only to claims presented to us by T.O.P's original customer and is in lieu of all other warranties expressed or implied.
- The defective product must be sent back to TOP with a Return Merchandise Authorization (RMA) issued by TOP for that specific product which states the nature of the defect or warranty claim. The original purchase information will be required.
- Product to be returned should be packed carefully. The Outdoor Plus is not responsible for shipping damage on returned items.
- RMA's are only valid for 30 days which states the nature of the defect or warranty claim after the expiration date.
- The RMA number must be indicated on the outside of the return package and a copy of the RMA should be placed in the package with product.
- TOP is not responsible for damaged caused by overheating, modification, abuse, improper storage, installation, or maintenance.
- TOP is not responsible for surface level rust on stainless steel products.
- TOP is not responsible for the actions including negligence of the installer.
- Any labor involving installation or maintenance with the unit is not covered.
- This warranty excludes claims for incidental or consequential damage and indirect collateral expenses arising from product defects or warranty recovery. Product manufactured by TOP including cLCus, UL, or CSA Certified models, cannot be altered or modified in any way.
- TOP is not responsible for local codes and will not accept a return on any product that is not approved for installation. Please check with your

local authorities or governing agencies for proper approvals before purchasing.

PRODUCT RETURN POLICY

No returns on made-to-order goods.

No returns on custom features, NO EXCEPTIONS.

If a product is delivered incorrectly, it is the recipients responsibility to notify TOP within 48 hours. TOP is not responsible for incorrect or damaged packages and shipments 48 hours after they have been received.

PRODUCT TESTING PROGRAM

If you believe a unit or component you received is defective, The Outdoor Plus will gladly test any component at T.O.P's facility. TOP will cover shipping back to you.

DEFECTIVE

If an item is found to be defective it will be repaired or replaced at T.O.P's discretion. TOP will absorb all costs of outgoing freight and replacement costs if product is in warranty.

NON-DEFECTIVE

If the product is found to be non-defective it will be returned to the customer - no credit will be given.

TOP ERROR

If a return is needed due to a mistake on T.O.P's part, we will issue a RMA and Return Services Label. When products are received at TOP, credit will be issued for the products and the outgoing freight on the original invoice.

CUSTOMER ERROR

If an RMA is asked for and covers current new products in the original package, we will authorize the return. The customer is responsible for the return shipping. When products are received we will issue credit for the original customer cost less a 25% restocking charge.

Custom orders do not apply.

FREIGHT POLICY

All orders will be shipped FOB Ontario, California, with a standard shipping carrier selected by TOP unless customer specifically requests their own carrier and account. A freight quote may be requested in advance. TOP works diligently with standard carriers to achieve the best discounts available.

BTU CALCULATOR

This BTU calculator is a tool used to help estimate the rate of BTU/hr for any burner from The Outdoor Plus. This is only an approximation, and exact BTU's will fluctuate with the rate and amount of gas that is being fed to the burner.

If you have a custom size or custom shape burner by us, you may contact us via email or phone with your sales order number ready so that we may calculate the BTU's for that specific burner.

Linear		Round		Triple 'S'		Square		Triangle		Lotus	
SIZE	BTU	SIZE	BTU	SIZE	BTU	SIZE	BTU	SIZE	BTU	SIZE	BTU
12"	20,000	6"	35,000	6"	30,000	6"	40,000	6"	30,000	12"	100,000
18"	30,000	8"	45,000	8"	40,000	8"	55,000	8"	40,000	18"	145,000
24"	40,000	12"	65,000	12"	60,000	12"	80,000	12"	60,000	24"	195,000
30"	50,000	18" (2 Rings)	160,000	18"	90,000	18" (2 Rings)	200,000	18" (2 Rings)	150,000	30"	240,000
36"	60,000	24" (2 Rings)	190,000	24"	120,000	24" (2 Rings)	240,000	24" (2 Rings)	180,000	36"	290,000
42"	70,000	30" (3 Rings)	330,000	30"	150,000	30" (3 Rings)	420,000	30" (3 Rings)	315,000	42"	340,000
48"	80,000	36" (3 Rings)	380,000	36"	180,000	36" (3 Rings)	480,000	36" (3 Rings)	360,000	48"	385,000
54"	90,000	48" (3 Rings)	630,000	42"	210,000	48" (4 Rings)	800,000	48" (4 Rings)	600,000	60"	480,000
60"	100,000			48"	240,000						
72"	120,000			60"	300,000						
84"	140,000										
96"	240,000										
108"	270,000										
120"	300,000										

H-Burner		
LENGTH	WIDTH	BTU
12"	6"	50,000
18"	6"	70,000
24"	6"	90,000
30"	6"	110,000
36"	6"	130,000
42"	6"	150,000
48"	6"	170,000
60"	6"	210,000
72"	6"	250,000
84"	6"	290,000
96"	6"	410,000
108"	6"	460,000
120"	6"	510,000
18"	12"	80,000
24"	12"	100,000
30"	12"	120,000
36"	12"	140,000
42"	12"	160,000
48"	12"	180,000
60"	12"	220,000
72"	12"	260,000
84"	12"	300,000
96"	12"	420,000
108"	12"	470,000
120"	12"	520,000

Rectangle		
LENGTH	WIDTH	BTU
12"	6"	60,000
18"	6"	80,000
24"	6"	100,000
30"	6"	120,000
36"	6"	140,000
42"	6"	160,000
48"	6"	180,000
60"	6"	220,000
72"	6"	260,000
84"	6"	370,000
96"	6"	420,000
108"	6"	470,000
120"	6"	520,000
18"	12"	100,000
24"	12"	120,000
30"	12"	140,000
36"	12"	160,000
42"	12"	180,000
48"	12"	200,000
60"	12"	240,000
72"	12"	280,000
84"	12"	390,000
96"	12"	440,000
108"	12"	490,000
120"	12"	540,000

Double Rectangle		
LENGTH	WIDTH	BTU
24"	12"	200,000
30"	12"	240,000
36"	12"	280,000
42"	12"	320,000
48"	12"	360,000
60"	12"	440,000
72"	12"	520,000
24"	18"	240,000
30"	18"	280,000
36"	18"	320,000
42"	18"	360,000
48"	18"	400,000
60"	18"	480,000
72"	18"	560,000

Switchback		
LENGTH	WIDTH	BTU
18"	6"	60,000
24"	6"	75,000
30"	6"	90,000
36"	6"	105,000
42"	6"	125,000
48"	6"	140,000
60"	6"	170,000
72"	6"	200,000
84"	6"	305,000
96"	6"	345,000
108"	6"	385,000
120"	6"	425,000

Classic GFRC Collection

T.O.P.'s classic smooth concrete finishes are some of the strongest out there. T.O.P.'s proprietary formula allows us to create an extremely durable product that also saves weight when compared to standard concrete. Unlike other concrete products on the market, T.O.P.'s products are colored all the way through. That means any surface damage that may occur is minimized whereas others only paint the surface of their white concrete leaving eyesores when chipped or scuffed. T.O.P.'s tinted sealers also help prevent water absorption and minimizes color variation so that you receive what you see in T.O.P.'s images.



COLOR SWATCHES

Premium Rustic Finishes

TOP's *Premium Rustic Finishes* are the latest options to T.O.P.'s line of GFRC finish options. Each product with rustic finish is unique for a more organic-stone look. The texture is only a couple millimeters deep, ensuring the same structural integrity as out smooth GFRC finishes.

Premium Metallic Finishes

TOP's *Premium Metallic Finishes* glimmer beautifully in the light and mimics the look of an anodized finish. T.O.P.'s metallic finishes can be applied to any of T.O.P.'s GFRC concrete products. It is designed to retain its shine and protect the concrete from harsh UV rays and natural outdoor elements,

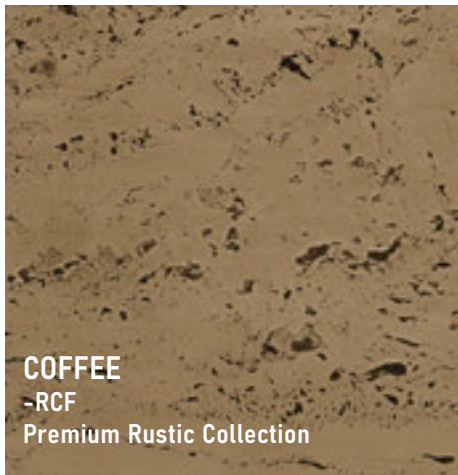
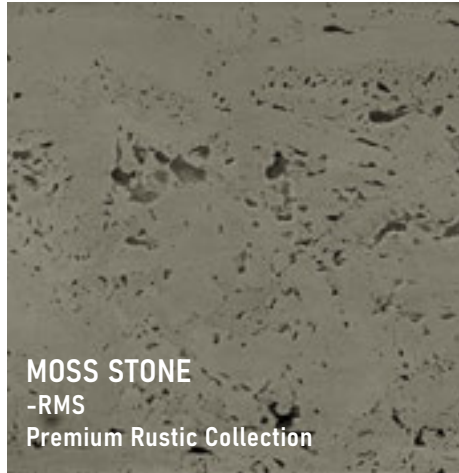

Classic Powder Coat Collection

TOP's Powder Coat finishes are UV resistant, discoloration resistant and are designed to protect against natural elements such as wind & moisture. The finishes are strong enough to resist damage from every day use, and will not chip or crack under normal use.



Premium Wood Grain Finishes

TOP's *Concrete Wood Grain Finishes* are designed to give a realistic wood look without the downsides of natural wood. Each unit is stained and finished by hand for a unique & realistic wood-grain look. Wood grain texture units retain all the structural integrity as T.O.P's smooth and rustic finishes to ensure the unit lasts for years to come.

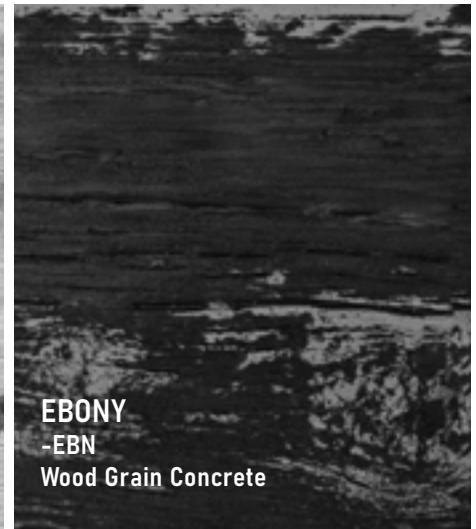
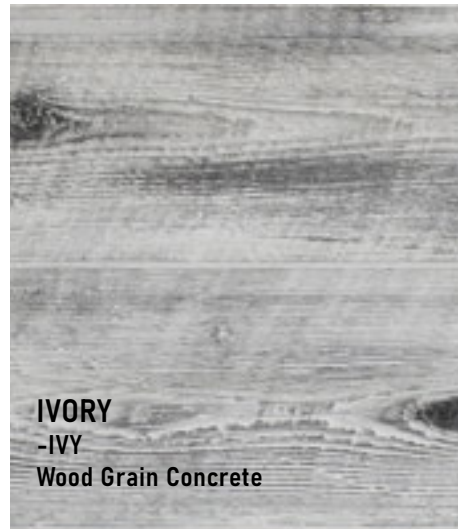
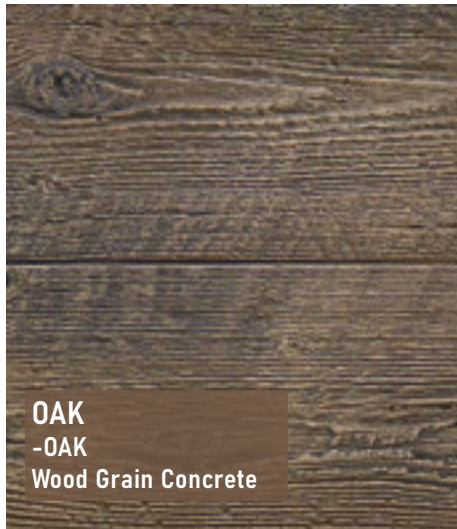

STAINLESS STEEL What Is It & How To Maintain It

What "Stainless" Really Means

Stainless Steel is a slightly misleading name. A more accurate description would be "Harder to Stain" Steel. The largest component of stainless steel is steel. Steel will rust. The chromium in stainless steel when exposed to oxygen in the atmosphere forms a thin invisible layer called chromium oxide and gives stainless steel its ability to resist stains and rust. If this layer is damaged, rust is formed on the surface at the point of the damage.

The good news is, with a little cleaning and care the chromium oxide layer is self-healing.

How can I clean my product without damaging it?

Avoid damaging the chromium oxide layer by avoiding the use of cleaners that contain chlorides (fluorine, chlorine, bromine, iodine, etc.). Cleaners containing alcohol, ammonia or mineral spirits can also damage the protective layer. DO NOT use steel wool or steel brushes as particles of these carbon steel articles may stick to the surface and begin to rust.

Stainless steel and the chromium oxide layer thrive on proper cleaning. For everyday cleaning of dust, dirt and fingerprints, a mild soap/detergent (dish detergent) and warm water solution should be used. Use the solution to remove the dust, rinsing with fresh water and a clean microfiber cloth. Finish by drying completely.

Removal of oxidized stains and even "surface rust" can be done by using a paste made from baking soda and water or a cleaner that contains oxalic acid, such as Bar Keeper's Friend Soft Cleanser.



What is Corten Steel?

Corten Steel is a high strength steel that creates its own weathering resistance. It is also referred to as Weathering Steel but the name COR-TEN™ has been a trademarked name used to generalize weathering steel.

This steel alloy has been used in architecture across the globe in wet & dry environments. It eliminates the need to paint & provides great protection all on its own

Is my product going to rust and destroy itself?

Not at all! At first glance, the rust may look alarming but rest assured your product is just fine. The weathered surface forms when the raw steel is exposed to the elements as self protection. Once it creates this surface, the material underneath is protected and structurally sound for many years to come.

COR-TEN™ has a weather resistance 4-8 times greater than that of raw mild steel. Each of T.O.P.'s COR-TEN™ Steel Products leave T.O.P.'s facilities with the light weathering process in progress. The texture of the COR-TEN™ Steel may be irregular but will even out with time and continue to darken and self regulate.

How will my product look after some time?

The image below shows the aging/patina process of COR-TEN™ Steel starting from left to right

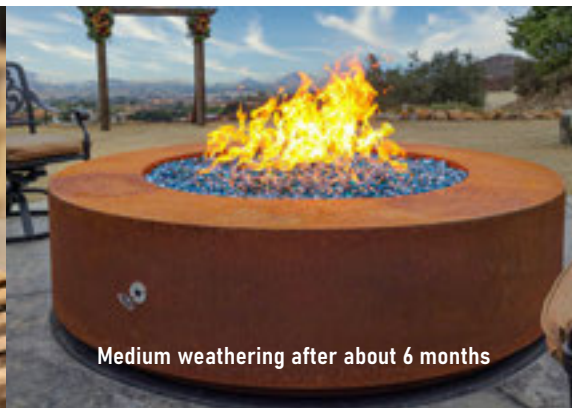
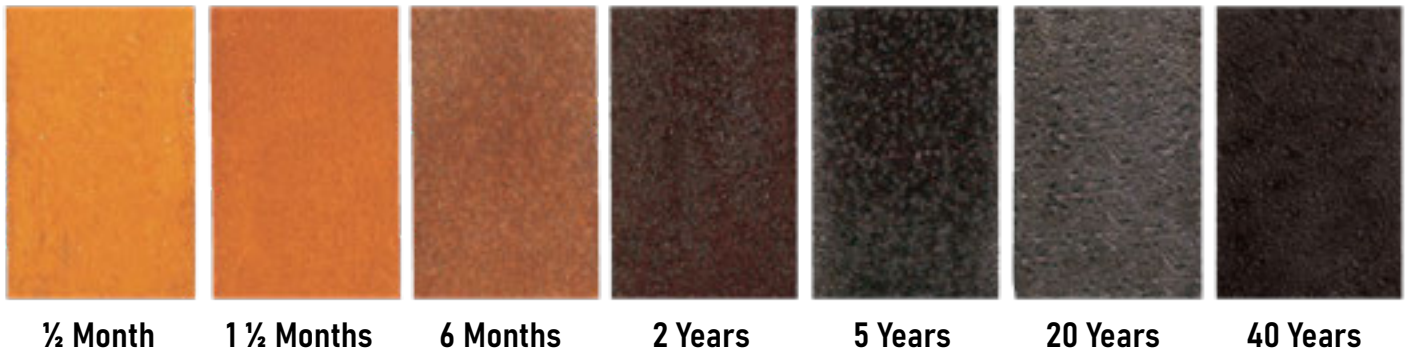

Surface Care, Treatment & Cleaning

The COR-TEN™ Steel will have a "rust" layer of residue which can be powdery and stain your skin and clothes, we suggest not grabbing or sitting on the COR-TEN™ Steel.

If you scuff or scratch the surface, the best thing to do is leave it alone and let the corten steel heal itself. The moisture in the air will help expedite this process. Another option is to lightly rub the surface with kitchen grade scotch bright and smooth it out.

If the unit becomes wet, like after rain showers, the water can carry the corten particles down the sides, drip and stain the floor. This can be power-washed with water.

COPPER Its Natural Properties & How To Maintain It

What is Copper?

It is a shiny, red metal and is used in various applications, including T.O.P.'s fire pits and other furnishings. It is a precious and soft, malleable metal that can be polished and artificially patina to create a beautiful finish.

Will my copper turn completely green?

To begin, it is impossible to completely prevent moisture from making contact with the copper so you will always get some naturally occurring patina. First the overall color will darken a bit over time. Secondly, if water sits on the surface, it may penetrate the coating and as it evaporates, can leave slight green stains. T.O.P.'s fire pits have a two coatings to help protect it against copper's naturally forming green patina. First, we apply a patina coating which is responsible for T.O.P.'s dark & rich finish on T.O.P.'s copper products. Second, we finish it off with a clear coat to seal it in and slow down moisture penetration.

To put it shortly, your fire pit will not turn entirely green, especially if you clean it well, and dry promptly.



The green speckles are a result of water constantly splashing on the surface and evaporating multiple times

Surface Care, Treatment & Cleaning

Avoid damaging the copper by avoiding the use of cleaners that contain chlorides, bleach, hydrogen peroxide, or any solvents. Cleaners containing alcohol, ammonia or mineral spirits can also damage the protective layer. DO NOT use steel wool or steel brushes as particles of these carbon steel articles may stick to the surface and begin to rust. A mild soap/detergent (dish detergent) and warm water solution should be used. Use the solution to remove the dust, rinsing with fresh water and a clean microfiber cloth to avoid scuffs. Finish by drying completely.

My surface looks dull and is starting to fade. What can I do?

If you feel like your copper's clear coating surface has worn away in certain high-contact spots (such as the tops that are commonly used as table tops) you can apply a coat of clear aerosol lacquer. Make sure to clean it of any dust, stains, markings, etc. before you do so as you will trap them under the lacquer if you don't.

POWDER COAT What Is It & How To Maintain It

What is Powder Coat

First off, powder coat is not paint. It is a powder that is electro-statically applied and then heated to fuse itself to the object it is applied on. This makes it more durable

How Can I Clean My Powder Coated Products?

To clean your products of normal dust and particles, you can use a mild water & detergent mix (dish soap is okay) and wipe it down with a soft cloth. Microfiber cloths will ensure you do not cause any abrasions. Be sure to dry any water droplets as they can cause water marks.

Preventing Stubborn Water Marks

Water marks and water stains form when water droplets sit and then evaporate on the surface of the product. This is because water has minerals, most commonly calcium and lime, and when the water evaporates, the calcium and lime is left behind leaving stubborn white rings. To prevent these stains from occurring, dry off any water before it evaporates.

There Are Harsh Water Marks On My Unit And Soap Wont Remove Them. What Can I Do?

You have a couple options here. One home remedy is to mix 1 parts vinegar with 1 parts warm water and spray it to the affected surfaces. After about a minute, you can then begin to wipe them off. Leave the vinegar mix on longer for more stubborn stains. Lastly, wipe off any residue and vinegar odor with a clean damp rag

Another remedy is using a cleaner called CLR (Calcium, Lime & Rust Remover). It is safe to use on powder coat finished and can be found in most grocery store stores and home improvement stores. Only apply to affected areas and do not let it sit on the surface for more than 30 seconds as it make damage the finish. Apply on a soft cloth and wipe the affected areas. Once dry, with a clean damp rag, wipe off any residue that may be on the surface.

