

BOWLS & PLANTERS



THE OUTDOOR PLUS

USA MANUFACTURER OF FIRE & WATER PRODUCTS



Official Distributor

800-971-1442 | orders@aquablumosaics.com
www.AquaBluMosaics.com

CAZO CONCRETE BOWLS

Cazo Planter Bowl

Includes: Bowl Only (Soil and plants not included.) (3" Opening)

24" Bowl OPT-24RP

- » Size: 24"
- » Height: 9"
- » Base: 9"
- » Soil Usage: 1 ft³

31" Bowl OPT-31RP

- » Size: 31"
- » Height: 10"
- » Base: 10"
- » Soil Usage: 2 ft³

36" Bowl OPT-36RP

- » Size: 36"
- » Height: 12"
- » Base: 14"
- » Soil Usage: 3 ft³

48" Bowl OPT-48RP

- » Size: 48"
- » Height: 16"
- » Base: 20"
- » Soil Usage: 1 ft³



24" ASH

Cazo Planter & Water Bowl

Includes: Bowl, Copper Scupper (¾" Inlet) (3" Opening)
(Soil and plants not included)

24" Bowl OPT-24RPW

- » Size: 24"
- » Height: 9"
- » Base: 9"
- » Scupper: 8"
- » Soil Usage: 1 ft³
- » GPM: 7-10

31" Bowl OPT-31RPW

- » Size: 31"
- » Height: 10"
- » Base: 10"
- » Scupper: 8"
- » Soil Usage: 2 ft³
- » GPM: 7-10

36" Bowl OPT-36RPW

- » Size: 36"
- » Height: 12"
- » Base: 14"
- » Scupper: 8"
- » Soil Usage: 3 ft³
- » GPM: 7-10

48" Bowl OPT-48RPW

- » Size: 48"
- » Height: 16"
- » Base: 20"
- » Scupper: 8"
- » Soil Usage: 1 ft³
- » GPM: 7-10



24" BROWN

Cazo Water Bowl

Includes: Bowl, Copper Spillway, & Smooth Flow Water Fitting (1 ½" Inlet)

24" Bowl OPT-24RWO

- » Size: 24"
- » Height: 9"
- » Base: 9"
- » Scupper: 8"
- » GPM: 7-10

31" Bowl OPT-31RWO

- » Size: 31"
- » Height: 10"
- » Base: 10"
- » Scupper: 8"
- » GPM: 7-10

36" Bowl OPT-36RWO

- » Size: 36"
- » Height: 12"
- » Base: 14"
- » Scupper: 8"
- » GPM: 7-10

48" Bowl OPT-48RWO

- » Size: 48"
- » Height: 16"
- » Base: 20"
- » Scupper: 8"
- » GPM: 7-10



24" NATURAL GRAY



All Water Bowls Include The Easy Flow Fitting

All Water Bowls come with easy-flow water fitting that accommodates a 1 ½" water line



Key Valve Upgrade

OPT-KVI

Installed Onto Bowl: Key Valve, Installation Bracket, & Gas Hoses

Optional Cazo Canvas Cover

24" Cover - OPT-BCVR-24R
31" Cover - OPT-BCVR-32R
36" Cover - OPT-BCVR-36R
48" Cover - OPT-BCVR-48R

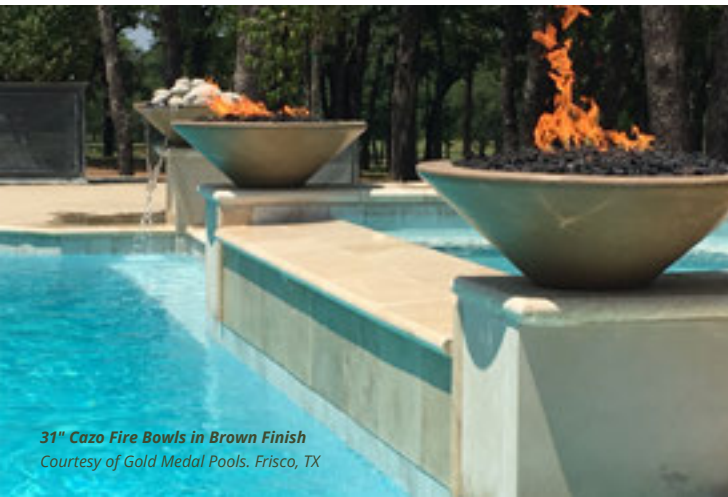

31" Cazo Fire Bowls in Brown Finish
Courtesy of Gold Medal Pools, Frisco, TX



31" Cazo Fire Bowls in Brown Finish — Courtesy of Horner Xpress

CAZO CONCRETE BOWLS



24" GRAY

Cazo Fire Bowl

Includes: Bowl, Fire Pan, Burner, Whistle Free Hose, Gas Orifice, Mounting Bracket, Lava Rock. (3" Opening)

24" Bowl

OPT-24RFO
OPT-24RFOE12V

- » Size: 24"
- » Height: 9"
- » Base: 9"
- » Burner: 8"
- » BTU: 45K
- » Sugg. Glass: 40 lbs.

31" Bowl

OPT-31RFO
OPT-31RFOE12V

- » Size: 31"
- » Height: 10"
- » Base: 10"
- » Burner: 12"
- » BTU: 65K
- » Sugg. Glass: 55lbs.

36" Bowl

OPT-36RFO
OPT-36RFOE12V

- » Size: 36"
- » Height: 12"
- » Base: 14"
- » Burner: 12"
- » BTU: 65K
- » Sugg. Glass: 95 lbs.

48" Bowl

OPT-48RFO
OPT-48RFOE12V

- » Size: 48"
- » Height: 16"
- » Base: 20"
- » Burner: 18"
- » BTU: 65K
- » Sugg. Glass: 200 lbs.



24" BLACK

Cazo Fire & Water Bowl

Includes: Bowl, Copper Scupper (¾" Inlet) Fire Pan, Burner, Whistle Free Hose, Gas Orifice, Mounting Bracket, Lava Rock. (3" Opening)

24" Bowl

OPT-24RFW
OPT-24RFWE12V

- » Size: 24"
- » Height: 9"
- » Base: 9"
- » Burner: 8"
- » BTU: 45K
- » Sugg. Glass: 40 lbs.
- » GPM: 7-10.

31" Bowl

OPT-31RFW
OPT-31RFWE12V

- » Size: 31"
- » Height: 10"
- » Base: 10"
- » Burner: 12"
- » BTU: 65K
- » Sugg. Glass: 55lbs.
- » GPM: 7-10.

36" Bowl

OPT-36RFW
OPT-36RFWE12V

- » Size: 36"
- » Height: 12"
- » Base: 14"
- » Burner: 12"
- » BTU: 65K
- » Sugg. Glass: 95 lbs.
- » GPM: 7-10.

48" Bowl

OPT-48RFW
OPT-48RFWE12V

- » Size: 48"
- » Height: 16"
- » Base: 20"
- » Burner: 18"
- » BTU: 65K
- » Sugg. Glass: 200 lbs.
- » GPM: 7-10.



48" GRAY

48" Cazo GFRC Fire & Water Bowl 360° Spill

Includes: Bowl, Fire Pan, Burner, Whistle Free Hose, Gas Orifice, Mounting Bracket, Lava Rock. (1 ½" Water Inlet)

OPT-48CZFW360
OPT-48CZFW360E12V

- » Size: 48"
- » Height: 17"
- » Base: 20"
- » Burner: 8"
- » BTU: 65K
- » Sugg. Glass: 25 lbs.
- » GPM: 40

When ordering, specify the concrete color by adding the color code to the end of the Part #. Example: 27" Brown Sedona Water Bowl = OPT-27RWO-BRN
Metallic Finishes and Rustic Finishes are available at an extra charge

Black -BLK	Ash -ASH	Natural Gray -NGY	Gray -GRY	White Limestone -LIM	Chocolate -CHC	Chestnut -CST	Brown -BRN	Vanilla -VAN
Rustic Gray -RGR	Moss Stone -RMS	Rustic White -RWH	Coffee -RCF	Slate -MSL	Silver -MSV	Pearl -MPR	Bronze -MBR	Copper -MCP

The Outdoor Plus individually handcrafts all products shown here. Finishes are subject to slight texture/color variations.

Proudly Made In The USA

SEDONA CONCRETE BOWLS

Planter Bowl

Includes: Bowl Only
(Soil and plants not included.) (3" Opening)

27" Bowl
OPT-27RP

- » Size: 27"
- » Height: 10"
- » Base: 12"
- » Soil Usage: 1.5 ft³

33" Bowl
OPT-33RP

- » Size: 33"
- » Height: 11"
- » Base: 18"
- » Soil Usage: 2.5 ft³



27" CHOCOLATE

Planter & Water Bowl

Includes: Bowl, Copper Scupper (¾" Inlet) (3" Opening)
(Soil and plants not included)

27" Bowl
OPT-27RPW

- » Size: 27"
- » Height: 10"
- » Base: 12"
- » Scupper: 8"
- » Soil Usage: 1.5 ft³
- » GPM: 7-10

33" Bowl
OPT-33RPW

- » Size: 33"
- » Height: 11"
- » Base: 18"
- » Scupper: 8"
- » Soil Usage: 2.5 ft³
- » GPM: 7-10



27" BROWN



27" LIMESTONE

Sedona Water Bowl

Includes: Bowl, Copper Spillway, &
Smooth Flow Water Fitting (1 ½" Inlet)

27" Bowl
OPT-27RWO

- » Size: 27"
- » Height: 10"
- » Base: 12"
- » Scupper: 8"
- » GPM: 7-10

33" Bowl
OPT-33RWO

- » Size: 33"
- » Height: 11"
- » Base: 18"
- » Scupper: 8"
- » GPM: 7-10

Sedona Fire Bowl

Includes: Bowl, Fire Pan, Burner, Whistle Free Hose,
Gas Orifice, Mounting Bracket, Lava Rock. (3" Opening)

27" Bowl
OPT-27RFO
OPT-27RFOE12V

- » Size: 27"
- » Height: 10"
- » Base: 12"
- » Burner: 8"
- » BTU: 45K
- » Sugg. Glass: 50 lbs.

33" Bowl
OPT-33RFO
OPT-33RFOE12V

- » Size: 33"
- » Height: 11"
- » Base: 18"
- » Burner: 12"
- » BTU: 65K
- » Sugg. Glass: 75lbs.



SEDONA CONCRETE BOWLS



27" CHESTNUT

Sedona Fire & Water Bowl

Includes: Bowl, Copper Scupper (¾" Inlet) Fire Pan, Burner, Whistle Free Hose, Gas Orifice, Mounting Bracket, Lava Rock. (3" Opening)

27" Bowl
OPT-27RFW
OPT-27RFWE12V

- » Size: 27"
- » Height: 10"
- » Base: 12"
- » Burner: 8"
- » BTU: 45K
- » Sugg. Glass: 50 lbs.
- » GPM: 7-10

33" Bowl
OPT-33RFW
OPT-33RFWE12V

- » Size: 33"
- » Height: 11"
- » Base: 18"
- » Burner: 12"
- » BTU: 65K
- » Sugg. Glass: 75lbs.
- » GPM: 7-10



46" BLACK

Sedona Fire & Water Bowl – 4-Way Spill

Includes: Bowl, Fire Pan, Burner, Whistle Free Hose, Gas Orifice, Mounting Bracket, Lava Rock. (1 ½" Water Inlet)

46" Bowl
OPT-46RFW4W
OPT-46RFW4WE12V

- » Size: 46"
- » Height: 16"
- » Base: 24"
- » Burner: 18"
- » BTU: 65K
- » Sugg. Glass: 50 lbs.
- » GPM: 40

60" Bowl
OPT-60RFW4W
OPT-60RFW4WE12V

- » Size: 60"
- » Height: 15"
- » Base: 38"
- » Burner: 18"
- » BTU: 65K
- » Sugg. Glass: 50 lbs.
- » GPM: 40



38" GRAY

38" Sedona Fire & Water Bowl – 360° Spill

Includes: Bowl, Fire Pan, Burner, Whistle Free Hose, Gas Orifice, Mounting Bracket, Lava Rock. (1 ½" Water Inlet)

OPT-38FW360
OPT-38FW360E12V

- » Size: 38"
- » Height: 16"
- » Base: 18"
- » Burner: 8"
- » BTU: 45K
- » Sugg. Glass: 16lbs.
- » GPM: 40



All Water Bowls Include The Easy Flow Fitting

All Water Bowls come with easy-flow water fitting that accommodates a 1 ½" water line



Key Valve Upgrade

OPT-KVI

Installed Onto Bowl: Key Valve, Installation Bracket, & Gas Hoses

Optional Sedona Canvas Cover

27" Cover - OPT-BCVR-27R
33" Cover - OPT-BCVR-33R
38" Cover - OPT-BCVR-38R
48" Cover - OPT-BCVR-38R

LUNA CONCRETE BOWLS



30" LIMESTONE

Luna Planter Bowl

Includes: Bowl Only
(Soil and plants not included.) (3" Opening)

30" Bowl
OPT-LUNPO30

- » Size: 30"
- » Height: 15"
- » Base: 14"
- » Soil Usage: 3 ft³

38" Bowl
OPT-LUNPO38

- » Size: 38"
- » Height: 16"
- » Base: 20"
- » Soil Usage: 5.75 ft³



38" NATURAL GRAY

Luna Planter & Water Bowl

Includes: Bowl, Copper Scupper (¾" Inlet) (3" Opening)
(Soil and plants not included)

30" Bowl
OPT-LUNPW30

- » Size: 30"
- » Height: 15"
- » Base: 14"
- » Soil Usage: 3 ft³
- » Scupper: 8"
- » GPM: 7-10

38" Bowl
OPT-LUNPW38

- » Size: 38"
- » Height: 16"
- » Base: 20"
- » Soil Usage: 5.75 ft³
- » Scupper: 8"
- » GPM: 7-10



All Water Bowls Include The Easy Flow Fitting

All Water Bowls come with easy-flow water fitting that accommodates a 1 ½" water line



Key Valve Upgrade

OPT-KVI

Installed Onto Bowl: Key Valve, Installation Bracket, & Gas Hoses

Optional Luna Canvas Cover

30" Cover - OPT-BCVR-30R
38" Cover - OPT-BCVR-38R

LUNA CONCRETE BOWLS



30" LIMESTONE

Luna Water Bowl

Includes: Bowl, Copper Spillway, & Smooth Flow Water Fitting (1 1/2" Inlet)

30" Bowl

OPT-LUNWO30

- » Size: 30"
- » Height: 15"
- » Base: 14"
- » GPM: 7-10

38" Bowl

OPT-LUNWO38

- » Size: 38"
- » Height: 16"
- » Base: 22"
- » GPM: 7-10



30" BROWN

Luna Fire Bowl

Includes: Bowl, Fire Pan, Burner, Whistle Free Hose, Gas Orifice, Mounting Bracket, Lava Rock. (3" Opening)

30" Bowl

OPT-LUNFO30

OPT-LUNFO30E12V

- » Size: 30"
- » Height: 15"
- » Base: 14"
- » Burner: 8"
- » BTU: 45K
- » Sugg. Glass: 50lbs.

38" Bowl

OPT-LUNFO38

OPT-LUNFO38E12V

- » Size: 38"
- » Height: 16"
- » Base: 22"
- » Burner: 12"
- » BTU: 65K
- » Sugg. Glass: 100 lbs.



30" CHESTNUT

Luna Fire & Water Bowl

Includes: Bowl, Copper Scupper (3/4" Inlet) Fire Pan, Burner, Whistle Free Hose, Gas Orifice, Mounting Bracket, Lava Rock. (3" Opening)

30" Bowl

OPT-LUNFW30

OPT-LUNFW30E12V

- » Size: 30"
- » Height: 15"
- » Base: 14"
- » Burner: 8"
- » BTU: 45K
- » Sugg. Glass: 50lbs.
- » GPM: 7-10

38" Bowl

OPT-LUNFW38

OPT-LUNFW38E12V

- » Size: 38"
- » Height: 16"
- » Base: 22"
- » Burner: 12"
- » BTU: 65K
- » Sugg. Glass: 100 lbs.
- » GPM: 7-10

When ordering, specify the concrete color by adding the color code to the end of the Part #. Example: 27" Brown Sedona Water Bowl = OPT-27RWO-BRN
Metallic Finishes and Rustic Finishes are available at an extra charge

Black -BLK	Ash -ASH	Natural Gray -NGY	Gray -GRY	White Limestone -LIM	Chocolate -CHC	Chestnut -CST	Brown -BRN	Vanilla -VAN
Rustic Gray -RGR	Moss Stone -RMS	Rustic White -RWH	Coffee -RCF	Slate -MSL	Silver -MSV	Pearl -MPR	Bronze -MBR	Copper -MCP

The Outdoor Plus individually handcrafts all products shown here. Finishes are subject to slight texture/color variations.

Proudly Made In The USA

MAYA CONCRETE BOWLS



24" LIMESTONE

Maya Planter Bowl

Includes: Bowl Only (Soil and plants not included.) (3" Opening)

24" Bowl OPT-24SP

- » Size: 24"
- » Height: 10 ¾"
- » Base: 13"
- » Soil Usage: 1 ft³

30" Bowl OPT-30SP

- » Size: 30"
- » Height: 10 ¼"
- » Base: 13"
- » Soil Usage: 2 ft³

36" Bowl OPT-36SP

- » Size: 36"
- » Height: 12"
- » Base: 20"
- » Soil Usage: 2 ft³



24" CHESTNUT

Maya Planter & Water Bowl

Includes: Bowl, Copper Scupper (¾" Inlet) (3" Opening)
(Soil and plants not included)

24" Bowl OPT-24SPW

- » Size: 24"
- » Height: 10 ¾"
- » Base: 13"
- » Soil Usage: 1 ft³
- » Scupper: 8"
- » GPM: 7-10

30" Bowl OPT-30SPW

- » Size: 30"
- » Height: 10 ¼"
- » Base: 13"
- » Soil Usage: 2 ft³
- » Scupper: 8"
- » GPM: 7-10

36" Bowl OPT-36SPW

- » Size: 36"
- » Height: 12"
- » Base: 20"
- » Soil Usage: 2 ft³
- » Scupper: 12"
- » GPM: 7-10



30" BLACK

Maya Water Bowl

Includes: Bowl, Copper Spillway, &
Smooth Flow Water Fitting (1 ½" Inlet)

24" Bowl OPT-24SWO

- » Size: 24"
- » Height: 10 ¾"
- » Base: 13"
- » Scupper: 8"
- » GPM: 7-10

30" Bowl OPT-30SWO

- » Size: 30"
- » Height: 10 ¼"
- » Base: 13"
- » Scupper: 8"
- » GPM: 7-10

36" Bowl OPT-36SWO

- » Size: 36"
- » Height: 12"
- » Base: 20"
- » Scupper: 12"
- » GPM: 7-10



30" BROWN

Maya Fire Bowl

Includes: Bowl, Fire Pan, Burner, Whistle Free Hose, Gas
Orifice, Mounting Bracket, Lava Rock. (3" Opening)

24" Bowl OPT-24SFO OPT-24SFOE12V

- » Size: 24"
- » Height: 10 ¾"
- » Base: 13"
- » Burner: 8"
- » BTU: 45K
- » Sugg. Glass: 50 lbs.

30" Bowl OPT-30SFO OPT-30SFOE12V

- » Size: 30"
- » Height: 10 ¼"
- » Base: 13"
- » Burner: 8"
- » BTU: 45K
- » Sugg. Glass: 50 lbs.

36" Bowl OPT-36SFO OPT-36SFOE12V

- » Size: 36"
- » Height: 12"
- » Base: 20"
- » Burner: 12"
- » BTU: 65K
- » Sugg. Glass: 50 lbs.



All Water Bowls Include The Easy Flow Fitting

All Water Bowls come with easy-flow
water fitting that accommodates a 1
½" water line



Key Valve Upgrade

OPT-KVI

Installed Onto Bowl: Key Valve,
Installation Bracket, & Gas Hoses

Optional Maya Canvas Cover

24" Cover - OPT-BCVR-2424
30" Cover - OPT-BCVR-3030
36" Cover - OPT-BCVR-3636
48" x 20" Cover - OPT-CVR4820

MAYA CONCRETE BOWLS



30" NATURAL GRAY

Maya Fire & Water Bowl

Includes: Bowl, Copper Scupper (¾" Inlet) Fire Pan, Burner, Whistle Free Hose, Gas Orifice, Mounting Bracket, Lava Rock. (3" Opening)

24" Bowl
OPT-24SFWS
OPT-24SFWE12V

- » Size: 24"
- » Height: 10.5"
- » Base: 13"
- » Burner: 8"
- » BTU: 45K
- » Sugg. Glass: 50 lbs.
- » Scupper: 8"
- » GPM: 7-10

30" Bowl
OPT-30SFWS
OPT-30SFWE12V

- » Size: 30"
- » Height: 10 ¼"
- » Base: 13"
- » Burner: 8"
- » BTU: 45K
- » Sugg. Glass: 50 lbs.
- » Scupper: 8"
- » GPM: 7-10

36" Bowl
OPT-36SFWS
OPT-36SFWE12V

- » Size: 36"
- » Height: 12"
- » Base: 20"
- » Burner: 12"
- » BTU: 65K
- » Sugg. Glass: 50 lbs.
- » Scupper: 10"
- » GPM: 7-10



30" BROWN

Maya Fire & Wide Spill Water Bowl

Includes: Bowl, Copper Scupper (¾" Inlet) Fire Pan, Burner, Whistle Free Hose, Gas Orifice, Mounting Bracket, Lava Rock. (3" Opening)

24" Bowl
OPT-24SFWWS
OPT-24SFWWSE12V

- » Size: 24"
- » Height: 10 ¾"
- » Base: 13"
- » Burner: 8"
- » BTU: 45K
- » Sugg. Glass: 50 lbs.
- » Scupper: 16"
- » GPM: 15

30" Bowl
OPT-30SFWWS
OPT-30SFWWSE12V

- » Size: 30"
- » Height: 10 ¼"
- » Base: 13"
- » Burner: 8"
- » BTU: 45K
- » Sugg. Glass: 50 lbs.
- » Scupper: 16"
- » GPM: 15

36" Bowl
OPT-36SFWWS
OPT-36SFWWSE12V

- » Size: 36"
- » Height: 12"
- » Base: 20"
- » Burner: 12"
- » BTU: 65K
- » Sugg. Glass: 50 lbs.
- » Scupper: 20"
- » GPM: 15



48" LIMESTONE

Linear Maya Fire Bowl

Includes: Bowl, Fire Pan, Burner, Whistle Free Hose, Gas Orifice, Lava Rock.

48" Bowl
OPT-4820MFO
OPT-4820MFOE12V

- » Size: 48" x 20"
- » Height: 12"
- » Base: 38" x 10"
- » Burner: 30" Linear
- » BTU: 50K
- » Sugg. Glass: 60 lbs.



48" LIMESTONE

Linear Maya Fire & Water

Includes: Bowl, Copper Scupper (¾" Inlet) Fire Pan, Burner, Whistle Free Hose, Gas Orifice, Lava Rock.

48" Bowl
OPT-4820MFW
OPT-4820MFW12V

- » Size: 48" x 20"
- » Height: 12"
- » Base: 38" x 10"
- » Burner: 30" Linear
- » BTU: 50K
- » Sugg. Glass: 60 lbs.
- » Scupper 36"
- » GPM: 20

AVALON CONCRETE BOWLS



24" BLACK

Avalon Planter Bowl

Includes: Bowl Only
(Soil and plants not included.) (3" Opening)

24" Bowl
OPT-AVLPO24

- » Size: 24"
- » Height: 10"
- » Base: 13"
- » Soil Usage: 1 ft³

30" Bowl
OPT-AVLPO30

- » Size: 30"
- » Height: 12"
- » Base: 18"
- » Soil Usage: 2 ft³

36" Bowl
OPT-AVLPO36

- » Size: 36"
- » Height: 12"
- » Base: 20"
- » Soil Usage: 2 ft³



24" LIMESTONE

Avalon Planter & Water Bowl

Includes: Bowl, Copper Scupper (¾" Inlet) (3" Opening)
(Soil and plants not included)

24" Bowl
OPT-AVLPW24

- » Size: 24"
- » Height: 10"
- » Base: 13"
- » Soil Usage: 1 ft³
- » Scupper: 8"
- » GPM: 7-10

30" Bowl
OPT-AVLPW30

- » Size: 30"
- » Height: 12"
- » Base: 18"
- » Soil Usage: 2 ft³
- » Scupper: 8"
- » GPM: 7-10

36" Bowl
OPT-AVLPW36

- » Size: 36"
- » Height: 12"
- » Base: 20"
- » Soil Usage: 2 ft³
- » Scupper: 12"
- » GPM: 7-10



24" BROWN

Avalon Water Bowl

Includes: Bowl, Copper Spillway, &
Smooth Flow Water Fitting (1 ½" Inlet)

24" Bowl
OPT-AVLWO24

- » Size: 24"
- » Height: 10"
- » Base: 13"
- » Scupper: 8"
- » GPM: 7-10

30" Bowl
OPT-AVLWO30

- » Size: 30"
- » Height: 12"
- » Base: 18"
- » Scupper: 8"
- » GPM: 7-10

36" Bowl
OPT-AVLWO36

- » Size: 36"
- » Height: 12"
- » Base: 20"
- » Scupper: 10"
- » GPM: 7-10



All Water Bowls Include The Easy Flow Fitting

All Water Bowls come with easy-flow water fitting that accommodates a 1 ½" water line



Key Valve Upgrade

OPT-KVI

Installed Onto Bowl: Key Valve, Installation Bracket, & Gas Hoses

Optional Avalon Canvas Cover

24" Cover - OPT-BCVR-2424
30" Cover - OPT-BCVR-3030
36" Cover - OPT-BCVR-3636

AVALON CONCRETE BOWLS



30" NATURAL GRAY

Avalon Fire Bowl

Includes: Bowl, Fire Pan, Burner, Whistle Free Hose, Gas Orifice, Mounting Bracket, Lava Rock. (3" Opening)

24" Bowl

OPT-AVLFO24
OPT-AVLFO24E12V

- » Size: 24"
- » Height: 10"
- » Base: 13"
- » Burner: 8"
- » BTU: 45K
- » Sugg. Glass: 40 lbs.

30" Bowl

OPT-AVLFO30
OPT-AVLFO30E12V

- » Size: 30"
- » Height: 12"
- » Base: 18"
- » Burner: 8"
- » BTU: 45K
- » Sugg. Glass: 55 lbs.

36" Bowl

OPT-AVLFO36
OPT-AVLFO36E12V

- » Size: 36"
- » Height: 12"
- » Base: 20"
- » Burner: 12"
- » BTU: 65K
- » Sugg. Glass: 95 lbs.



30" LIMESTONE

Avalon Fire & Water Bowl

Includes: Bowl, Copper Scupper (¾" Inlet) Fire Pan, Burner, Whistle Free Hose, Gas Orifice, Mounting Bracket, Lava Rock. (3" Opening)

24" Bowl

OPT-AVLFW24
OPT-AVLFW24E12V

- » Size: 24"
- » Height: 10"
- » Base: 13"
- » Burner: 8"
- » BTU: 45K
- » Sugg. Glass: 40 lbs.
- » Scupper: 8"
- » GPM: 7-10

30" Bowl

OPT-AVLFW30
OPT-AVLFW30E12V

- » Size: 30"
- » Height: 12"
- » Base: 18"
- » Burner: 12"
- » BTU: 65K
- » Sugg. Glass: 55 lbs.
- » Scupper: 8"
- » GPM: 7-10

36" Bowl

OPT-AVLFW36
OPT-AVLFW36E12V

- » Size: 36"
- » Height: 12"
- » Base: 20"
- » Burner: 12"
- » BTU: 65K
- » Sugg. Glass: 95 lbs.
- » Scupper: 10"
- » GPM: 7-10

When ordering, specify the concrete color by adding the color code to the end of the Part #. Example: 27" Brown Sedona Water Bowl = OPT-27RWO-BRN
Metallic Finishes and Rustic Finishes are available at an extra charge

Black -BLK	Ash -ASH	Natural Gray -NGY	Gray -GRY	White Limestone -LIM	Chocolate -CHC	Chestnut -CST	Brown -BRN	Vanilla -VAN
Rustic Gray -RGR	Moss Stone -RMS	Rustic White -RWH	Coffee -RCF	Slate -MSL	Silver -MSV	Pearl -MPR	Bronze -MBR	Copper -MCP

The Outdoor Plus individually handcrafts all products shown here. Finishes are subject to slight texture/color variations.

Proudly Made In The USA

ROMA CONCRETE BOWLS



24" VANILLA

Roma Planter Bowl

Includes: Bowl Only
(Soil and plants not included.) (3" Opening)

24" Bowl

OPT-ROMPO24

- » Size: 24"
- » Height: 10"
- » Base: 9"
- » Soil Usage: 1 ft³

36" Bowl

OPT-ROMPO36

- » Size: 36"
- » Height: 16"
- » Base: 18"
- » Soil Usage: 2 ft³

Roma Planter & Water Bowl

Includes: Bowl, Copper Scupper (¾" Inlet) (14" Opening)
(Soil and plants not included)

24" Bowl

OPT-ROMPW24

- » Size: 24"
- » Height: 10"
- » Base: 9"
- » Soil Usage: 1 ft³
- » Scupper: 8"
- » GPM: 7-10

36" Bowl

OPT-ROMPW36

- » Size: 36"
- » Height: 16"
- » Base: 18"
- » Soil Usage: 2 ft³
- » Scupper: 8"
- » GPM: 7-10



36" CHOCOLATE

Roma Water Bowl

Includes: Bowl, Copper Spillway, &
Smooth Flow Water Fitting (1 ½" Inlet)

24" Bowl

OPT-ROMWO24

- » Size: 24"
- » Height: 10"
- » Base: 9"
- » Scupper: 8"
- » GPM: 7-10

36" Bowl

OPT-ROMWO36

- » Size: 36"
- » Height: 16"
- » Base: 18"
- » Scupper: 8"
- » GPM: 7-10



All Water Bowls Include The Easy Flow Fitting

All Water Bowls come with easy-flow water fitting that accommodates a 1 ½" water line



Key Valve Upgrade

OPT-KVI

Installed Onto Bowl: Key Valve, Installation Bracket, & Gas Hoses

Optional Roma Canvas Cover

24" Cover - OPT-BCVR-24R
37" Cover - OPT-BCVR-37R

ROMA CONCRETE BOWLS



36" BROWN

Roma Fire Bowl

Includes: Bowl, Fire Pan, Burner, Whistle Free Hose, Gas Orifice, Mounting Bracket, Lava Rock. (14" Opening)

24" Bowl

OPT-ROMFO24
OPT-ROMFO24E12V

- » Size: 24"
- » Height: 10"
- » Base: 9"
- » Burner: 8"
- » BTU: 45K
- » Sugg. Glass: 40 lbs.

36" Bowl

OPT-ROMFO36
OPT-ROMFO36E12V

- » Size: 36"
- » Height: 16"
- » Base: 18"
- » Burner: 12"
- » BTU: 45K
- » Sugg. Glass: 55 lbs.



36" NATURAL
GRAY

Roma Fire & Water Bowl

Includes: Bowl, Copper Scupper (3/4" Inlet) Fire Pan, Burner, Whistle Free Hose, Gas Orifice, Mounting Bracket, Lava Rock. (14" Opening)

24" Bowl

OPT-ROMFW24
OPT-ROMFW24E12V

- » Size: 24"
- » Height: 10"
- » Base: 9"
- » Burner: 8"
- » BTU: 45K
- » Sugg. Glass: 40 lbs.
- » Scupper: 8"
- » GPM: 7-10

36" Bowl

OPT-ROMFW36
OPT-ROMFW36E12V

- » Size: 36"
- » Height: 16"
- » Base: 18"
- » Burner: 12"
- » BTU: 65K
- » Sugg. Glass: 55 lbs.
- » Scupper: 8"
- » GPM: 7-10

When ordering, specify the concrete color by adding the color code to the end of the Part #. Example: 27" Brown Sedona Water Bowl = OPT-27RWO-BRN
Metallic Finishes and Rustic Finishes are available at an extra charge

Black -BLK	Ash -ASH	Natural Gray -NGY	Gray -GRY	White Limestone -LIM	Chocolate -CHC	Chestnut -CST	Brown -BRN	Vanilla -VAN
Rustic Gray -RGR	Moss Stone -RMS	Rustic White -RWH	Coffee -RCF	Slate -MSL	Silver -MSV	Pearl -MPR	Bronze -MBR	Copper -MCP

The Outdoor Plus individually handcrafts all products shown here. Finishes are subject to slight texture/color variations.

Proudly Made In The USA

SEDONA BOWLS - WOOD GRAIN CONCRETE

Sedona Water Bowl

Includes: Bowl, Copper Spillway, & Smooth Flow Water Fitting (1 1/2" Inlet)

27" Bowl

OPT-27RWGWO

- » Size: 27"
- » Height: 10"
- » Base: 12"
- » Scupper: 8"
- » GPM: 7-10

Sedona Planter Bowl

Includes: Bowl Only
(Soil and plants not included.) (3" Opening)

27" Bowl

OPT-27RWGWO

- » Size: 27"
- » Height: 10"
- » Base: 12"
- » Soil Usage: 1.5 ft³

Sedona Planter & Water Bowl

Includes: Bowl, Copper Scupper (3/4" Inlet) (3" Opening)
(Soil and plants not included)

27" Bowl

OPT-27RWGWP

- » Size: 27"
- » Height: 10"
- » Base: 12"
- » Soil Usage: 1.5 ft³
- » Scupper: 8"
- » GPM: 7-10



27" OAK

The Outdoor Plus individually handcrafts all products shown here. Finishes are subject to slight texture/color variations.



27" Sedona Planter & Water Bowl in Ivory Wood Grain Finish

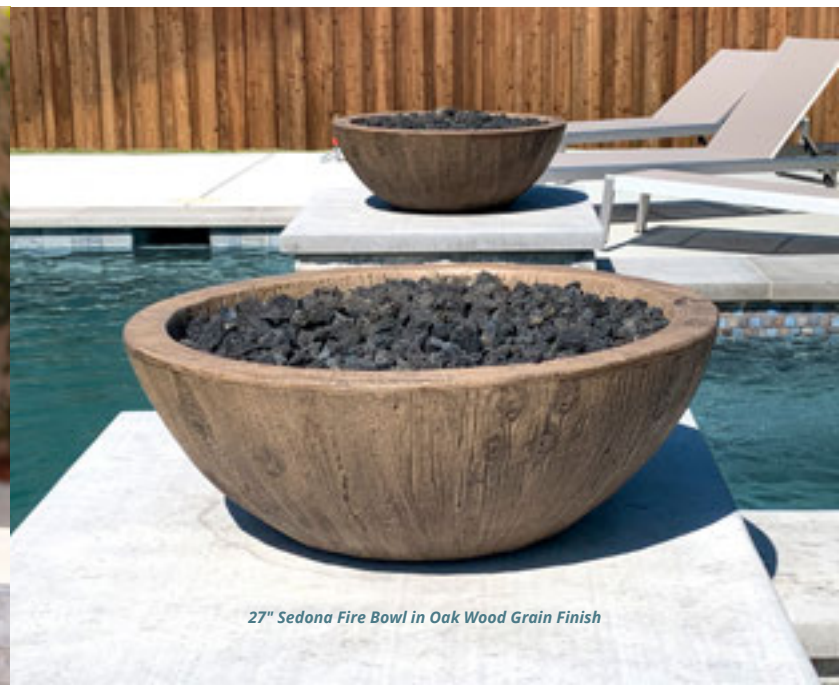

27" Sedona Fire Bowl in Oak Wood Grain Finish

SEDONA BOWLS - WOOD GRAIN CONCRETE

Sedona Fire Bowl

Includes: Bowl, Fire Pan, Burner, Whistle Free Hose, Gas Orifice, Mounting Bracket, Lava Rock. (3" Opening)

27" Bowl

OPT-27RWGFO
OPT-27RWGFOE12V

- » Size: 27"
- » Height: 10"
- » Base: 12"
- » Burner: 8"
- » BTU: 45K
- » Sugg. Glass: 20 lbs.



27" IVORY

Sedona Fire & Water Bowl

Includes: Bowl, Copper Scupper (¾" Inlet) Fire Pan, Burner, Whistle Free Hose, Gas Orifice, Mounting Bracket, Lava Rock. (3" Opening)

27" Bowl

OPT-27RWGFW
OPT-27RWGFW12V

- » Size: 27"
- » Height: 10"
- » Base: 12"
- » Burner: 8"
- » BTU: 45K
- » Sugg. Glass: 20 lbs.
- » Scupper: 8"
- » GPM: 7-10



27" EBONY



GFRC WOOD GRAIN COLOR OPTIONS

When ordering, specify the color by adding the color code to the end of the Part #.
Example: Coronado Fire Pit in Ivory = OPT-COR48-IVY



All Water Bowls Include The Easy Flow Fitting

All Water Bowls come with easy-flow water fitting that accommodates a 1 ½" water line



Key Valve Upgrade
OPT-KVI

Installed Onto Bowl: Key Valve, Installation Bracket, & Gas Hoses

Optional Sedona Canvas Cover
27" Cover - OPT-BCVR-27R

MAYA BOWLS - WOOD GRAIN CONCRETE

Maya Planter Bowl

Includes: Bowl Only
(Soil and plants not included.) (3" Opening)

24" Bowl
OPT-24SWGPO

- » Size: 24"
- » Height: 10.5"
- » Base: 13"
- » Soil Usage: 1.5 ft³

30" Bowl
OPT-30SWGPO

- » Size: 30"
- » Height: 10.5"
- » Base: 13"
- » Soil Usage: 2 ft³

Maya Planter & Water Bowl

Includes: Bowl, Copper Scupper (¾" Inlet) (3" Opening)
(Soil and plants not included)

24" Bowl
OPT-24SWGPPW

- » Size: 24"
- » Height: 10.5"
- » Base: 13"
- » Soil Usage: 1.5 ft³
- » Scupper: 8"
- » GPM: 7-10

30" Bowl
OPT-30SWGPPW

- » Size: 30"
- » Height: 10.5"
- » Base: 13"
- » Soil Usage: 2 ft³
- » Scupper: 8"
- » GPM: 7-10



30" OAK

Maya Water Bowl

Includes: Bowl, Copper Spillway, &
Smooth Flow Water Fitting (1 ½" Inlet)

24" Bowl
OPT-24SWGWO

- » Size: 24"
- » Height: 10.5"
- » Base: 13"
- » Scupper: 8"
- » GPM: 7-10

30" Bowl
OPT-30SWGWO

- » Size: 30"
- » Height: 10.5"
- » Base: 13"
- » Scupper: 8"
- » GPM: 7-10



30" OAK



GFRC WOOD GRAIN COLOR OPTIONS

When ordering, specify the color by adding the color code to the end of the Part #.
Example: Coronado Fire Pit in Ivory = OPT-COR48-IVY

MAYA BOWLS - WOOD GRAIN CONCRETE

Maya Fire Bowl

Includes: Bowl, Fire Pan, Burner, Whistle Free Hose, Gas Orifice, Mounting Bracket, Lava Rock. (3" Opening)

24" Bowl

OPT-24SWGFO
OPT-24SWGFOE12V

- » Size: 24"
- » Height: 10.5"
- » Base: 13"
- » Burner: 8"
- » BTU: 45K
- » Sugg. Glass: 20 lbs.

30" Bowl

OPT-30SWGFO
OPT-30SWGFOE12V

- » Size: 30"
- » Height: 10.5"
- » Base: 13"
- » Burner: 8"
- » BTU: 45K
- » Sugg. Glass: 20 lbs.



30" EBONY

Maya Fire & Water Bowl

Includes: Bowl, Copper Scupper (3/4" Inlet) Fire Pan, Burner, Whistle Free Hose, Gas Orifice, Mounting Bracket, Lava Rock. (3" Opening)

24" Bowl

OPT-24SWGFW
OPT-24SWGFWWE12V

- » Size: 24"
- » Height: 10.5"
- » Base: 13"
- » Burner: 8"
- » BTU: 45K
- » Sugg. Glass: 20 lbs.
- » Scupper: 8"
- » GPM: 7-10

30" Bowl

OPT-30SWGFW
OPT-30SWGFWWE12V

- » Size: 30"
- » Height: 10.5"
- » Base: 13"
- » Burner: 8"
- » BTU: 45K
- » Sugg. Glass: 20 lbs.
- » Scupper: 8"
- » GPM: 7-10



30" IVORY

Maya Fire & Wide Spill Water Bowl

Includes: Bowl, Copper Scupper (3/4" Inlet) Fire Pan, Burner, Whistle Free Hose, Gas Orifice, Mounting Bracket, Lava Rock. (3" Opening)

24" Bowl

OPT-24SWGFWWS
OPT-24SWGFWWSE12V

- » Size: 24"
- » Height: 10.5"
- » Base: 13"
- » Burner: 8"
- » BTU: 45K
- » Sugg. Glass: 20 lbs.
- » Scupper: 8"
- » GPM: 15

30" Bowl

OPT-30SWGFWWS
OPT-30SWGFWWSE12V

- » Size: 30"
- » Height: 10.5"
- » Base: 13"
- » Burner: 8"
- » BTU: 45K
- » Sugg. Glass: 20 lbs.
- » Scupper: 8"
- » GPM: 15



24" IVORY



All Water Bowls Include The Easy Flow Fitting

All Water Bowls come with easy-flow water fitting that accommodates a 1 1/2" water line



Key Valve Upgrade

OPT-KVI

Installed Onto Bowl: Key Valve, Installation Bracket, & Gas Hoses

Optional Maya Canvas Cover

24" Cover - OPT-BCVR-2424
30" Cover - OPT-BCVR-3030

Cazo Planter Bowl

Includes: Bowl Only
(Soil and plants not included.) (3" Opening)

24" Bowl

OPT-24RWGPO

- » Size: 24"
- » Height: 8"
- » Base: 12"
- » Soil Usage: 1.5 ft³

32" Bowl

OPT-32RWGPO

- » Size: 32"
- » Height: 11"
- » Base: 12"
- » Soil Usage: 2 ft³



32" EBONY

Cazo Planter & Water Bowl

Includes: Bowl, Copper Scupper (¾" Inlet) (3" Opening)
(Soil and plants not included)

24" Bowl

OPT-24RWGPW

- » Size: 24"
- » Height: 8"
- » Base: 12"
- » Soil Usage: 1.5 ft³
- » Scupper: 8"
- » GPM: 7-10

32" Bowl

OPT-32RWGPW

- » Size: 32"
- » Height: 11"
- » Base: 12"
- » Soil Usage: 2 ft³
- » Scupper: 8"
- » GPM: 7-10

Cazo Water Bowl

Includes: Bowl, Copper Spillway, &
Smooth Flow Water Fitting (1 ½" Inlet)

24" Bowl

OPT-24RWGWO

- » Size: 24"
- » Height: 8"
- » Base: 12"
- » Scupper: 8"
- » GPM: 7-10

32" Bowl

OPT-32RWGWO

- » Size: 32"
- » Height: 10"
- » Base: 12"
- » Scupper: 8"
- » GPM: 7-10



32" IVORY



Ebony
-EBN

Ivory
-IVY

Oak
-OAK

GFRC WOOD GRAIN COLOR OPTIONS

When ordering, specify the color by adding the color code to the end of the Part #.

Example: Coronado Fire Pit in Ivory = OPT-COR48-IVY

CAZO BOWLS - WOOD GRAIN CONCRETE

Cazo Fire Bowl

Includes: Bowl, Fire Pan, Burner, Whistle Free Hose, Gas Orifice, Mounting Bracket, Lava Rock. (3" Opening)

24" Bowl

OPT-24RWGFO
OPT-24RWGFOE12V

- » Size: 24"
- » Height: 8"
- » Base: 12"
- » Burner: 8"
- » BTU: 45K
- » Sugg. Glass: 20 lbs.

32" Bowl

OPT-32RWGFO
OPT-32RWGFOE12V

- » Size: 32"
- » Height: 10"
- » Base: 12"
- » Burner: 8"
- » BTU: 45K
- » Sugg. Glass: 20 lbs.



32" OAK

Cazo Fire & Water Bowl

Includes: Bowl, Copper Scupper (¾" Inlet) Fire Pan, Burner, Whistle Free Hose, Gas Orifice, Mounting Bracket, Lava Rock. (3" Opening)

24" Bowl

OPT-24RWGFW
OPT-24RWGFWWE12V

- » Size: 24"
- » Height: 8"
- » Base: 12"
- » Burner: 8"
- » BTU: 45K
- » Sugg. Glass: 20 lbs.
- » Scupper: 8"
- » GPM: 7-10

32" Bowl

OPT-32RWGFW
OPT-32RWGFWWE12V

- » Size: 32"
- » Height: 10"
- » Base: 12"
- » Burner: 8"
- » BTU: 45K
- » Sugg. Glass: 20 lbs.
- » Scupper: 8"
- » GPM: 7-10



32" EBONY



All Water Bowls Include The Easy Flow Fitting

All Water Bowls come with easy-flow water fitting that accommodates a 1 ½" water line



Key Valve Upgrade

OPT-KVI

Installed Onto Bowl: Key Valve, Installation Bracket, & Gas Hoses

Optional Cazo Canvas Cover

24" Cover - OPT-BCVR-24R
32" Cover - OPT-BCVR-32R

Cazo Planter Bowl

Includes: Bowl Only
(Soil and plants not included.) (3" Opening)



24" Bowl
OPT-R24CPO

- » Size: 24"
- » Height: 10"
- » Base: 10"
- » Soil Usage: 1.25 ft³

30" Bowl
OPT-R30CPO

- » Size: 30"
- » Height: 12"
- » Base: 15"
- » Soil Usage: 3 ft³

36" Bowl
OPT-R36CPO

- » Size: 36"
- » Height: 12"
- » Base: 15"
- » Soil Usage: 4.5 ft³

Cazo Planter & Water Bowl

Includes: Bowl, Copper Scupper (¾" Inlet) (3" Opening)
(Soil and plants not included)

24" Bowl
OPT-R24CPW

- » Size: 24"
- » Height: 10"
- » Base: 10"
- » Soil Usage: 1.25 ft³
- » Scupper: 8"
- » GPM: 7-10

30" Bowl
OPT-R30CPW

- » Size: 30"
- » Height: 12"
- » Base: 15"
- » Soil Usage: 3 ft³
- » Scupper: 8"
- » GPM: 7-10

36" Bowl
OPT-R36CPW

- » Size: 36"
- » Height: 12"
- » Base: 15"
- » Soil Usage: 4.5 ft³
- » Scupper: 10"
- » GPM: 10

Cazo Water Bowl

Includes: Bowl, Copper Spillway
(1 ½" Water Inlet)



24" Bowl
OPT-R24CPWO

- » Size: 24"
- » Height: 10"
- » Base: 10"
- » Scupper: 8"
- » GPM: 7-10

30" Bowl
OPT-R30CPWO

- » Size: 30"
- » Height: 12"
- » Base: 15"
- » Scupper: 8"
- » GPM: 7-10

36" Bowl
OPT-R36CPWO

- » Size: 36"
- » Height: 12"
- » Base: 15"
- » Scupper: 12"
- » GPM: 10

Cazo Fire Bowl

Includes: Bowl, Fire Pan, Burner, Whistle Free Hose, Gas Orifice,
Mounting Bracket, Lava Rock. (3" Opening)



24" Bowl
OPT-101-24NWF
OPT-101-24NWF12V

- » Size: 24"
- » Height: 10"
- » Base: 10"
- » Burner: 8"
- » BTU: 45K
- » Sugg. Glass: 20 lbs.

30" Bowl
OPT-102-30NWF
OPT-102-30NWF12V

- » Size: 30"
- » Height: 12"
- » Base: 15"
- » Burner: 8"
- » BTU: 45K
- » Sugg. Glass: 35 lbs.

36" Bowl
OPT-102-36NWF
OPT-102-36NWF12V

- » Size: 36"
- » Height: 12"
- » Base: 15"
- » Burner: 12"
- » BTU: 65K
- » Sugg. Glass: 50 lbs.



All Water Bowls Include The Easy Flow Fitting

All Water Bowls come with easy-flow water fitting that accommodates a 1 ½" water line



Key Valve Upgrade

OPT-KVI

Installed Onto Bowl: Key Valve, Installation Bracket, & Gas Hoses

Optional Cazo Canvas Cover

24" Cover - OPT-BCVR-24R
30" Cover - OPT-BCVR-30R
36" Cover - OPT-BCVR-36R

CAZO COPPER BOWL



Cazo Fire & Water Bowl

Includes: Bowl, Copper Scupper (¾" Inlet) Fire Pan, Burner, Whistle Free Hose, Gas Orifice, Mounting Bracket, Lava Rock. (3" Opening)

24" Bowl

OPT-101-24NWCB
OPT-101-24NWCBE12V

- » Size: 24"
- » Height: 10"
- » Base: 10"
- » Burner: 8"
- » BTU: 45K
- » Sugg. Glass: 20 lbs.
- » Scupper: 8"
- » GPM: 7-10

30" Bowl

OPT-102-30NWCB
OPT-102-30NWCBE12V

- » Size: 30"
- » Height: 12"
- » Base: 15"
- » Burner: 8"
- » BTU: 45K
- » Sugg. Glass: 35 lbs.
- » Scupper: 8"
- » GPM: 7-10

36" Bowl

OPT-102-36NWCB
OPT-102-36NWCBE12V

- » Size: 36"
- » Height: 12"
- » Base: 15"
- » Burner: 12"
- » BTU: 65K
- » Sugg. Glass: 50 lbs.
- » Scupper: 8"
- » GPM: 7-10



Cazo Fire & Water Bowl, 4-Way Spill

Includes: Bowl, Fire Pan, Burner, Whistle Free Hose, Gas Orifice, Lava Rock. (1 ½" Water Inlet)

30" Bowl

OPT-4W30
OPT-4W30E12V

- » Size: 30"
- » Height: 12"
- » Base: 16"
- » Burner: 12"
- » BTU: 65K
- » Sugg. Glass: 40 lbs.
- » Scupper: 8"
- » GPM: 30
- » Water Inlet: 1 ½"

36" Bowl

OPT-4W36
OPT-4W36E12V

- » Size: 36"
- » Height: 12"
- » Base: 20"
- » Burner: 12"
- » BTU: 65K
- » Sugg. Glass: 55 lbs.
- » Scupper: 8"
- » GPM: 30
- » Water Inlet: 1 ½"

Cazo Fire & Water Bowl- 360° Spill

Includes: Bowl, Fire Pan, Burner, Whistle Free Hose, Gas Orifice, Lava Rock. (1 ½" Water Inlet)

30" Bowl

OPT-30FW360
OPT-30FW360E12V

- » Size: 30"
- » Height: 13.5"
- » Base: 16"
- » Burner: 6"
- » BTU: 45K
- » Sugg. Glass: 35 lbs.
- » GPM: 15
- » Water Inlet: 1 ½"

36" Bowl

OPT-36FW360
OPT-36FW360E12V

- » Size: 36"
- » Height: 13.5"
- » Base: 20"
- » Burner: 8"
- » BTU: 45K
- » Sugg. Glass: 35 lbs.
- » GPM: 15
- » Water Inlet: 1 ½"



30" Cazo Fire & Water Bowl, 4-Way Spill - OPT-4W30
Courtesy of Pool Logic Design & Construction, CA

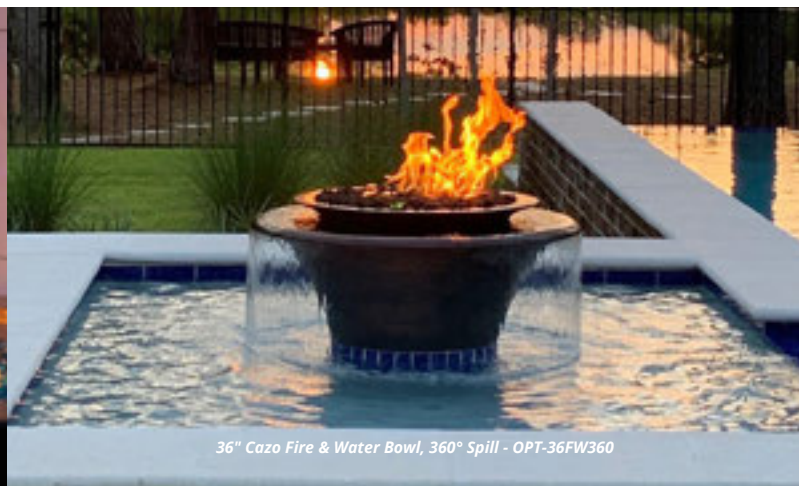

36" Cazo Fire & Water Bowl, 360° Spill - OPT-36FW360



Sedona Planter Bowl

Includes: Bowl Only
(Soil and plants not included.) (3" Opening)

27" Bowl

OPT-27RCRPO

- » Size: 27"
- » Height: 10"
- » Base: 12"
- » Soil Usage: 1.5 ft³

Sedona Planter & Water Bowl

Includes: Bowl, Copper Scupper (¾" Inlet) (3" Opening)
(Soil and plants not included)

27" Bowl

OPT-27RCRPW

- » Size: 27"
- » Height: 10"
- » Base: 12"
- » Soil Usage: 1.5 ft³
- » Scupper: 8"
- » GPM: 7-10



Sedona Water Bowl

Includes: Bowl, Copper Spillway
(1 ½" Water Inlet)

27" Bowl

OPT-27RCPRWO

- » Size: 27"
- » Height: 10"
- » Base: 12"
- » Scupper: 8"
- » GPM: 7-10



Sedona Fire Bowl

Includes: Bowl, Fire Pan, Burner, Whistle Free Hose,
Gas Orifice, Mounting Bracket, Lava Rock. (3" Opening)

27" Bowl

OPT-27RCPRFO
OPT-27RCPRFOE12V

- » Size: 27"
- » Height: 10"
- » Base: 12"
- » Burner: 8"
- » BTU: 45K
- » Sugg. Glass: 20 lbs.



All Water Bowls Include The Easy Flow Fitting

All Water Bowls come with easy-flow water fitting that accommodates a 1 ½" water line



Key Valve Upgrade

OPT-KVI

Installed Onto Bowl: Key Valve, Installation Bracket, & Gas Hoses

Optional Sedona Canvas Cover

27" Cover - OPT-BCVR-27R

SEDONA COPPER BOWL



Sedona Fire & Water Bowl

Includes: Bowl, Copper Scupper (¾" Inlet) Fire Pan, Burner, Whistle Free Hose, Gas Orifice, Mounting Bracket, Lava Rock. (3" Opening)

27" Bowl

OPT-27RCPRFW
OPT-27RCPRFWE12V

- » Size: 27"
- » Height: 10"
- » Base: 12"
- » Burner: 8"
- » BTU: 45K
- » Sugg. Glass: 20 lbs.
- » Scupper: 8"
- » GPM: 7-10



Sedona Fire & Water Bowl - Gravity Spill

Includes: Bowl, Copper Scupper (¾" Inlet) Fire Pan, Burner, Whistle Free Hose, Gas Orifice, Mounting Bracket, Lava Rock. (3" Opening)

27" Bowl

OPT-27RCPRFWGS
OPT-27RCPRFWGSE12V

- » Size: 27"
- » Height: 10"
- » Base: 12"
- » Burner: 8"
- » BTU: 45K
- » Sugg. Glass: 20 lbs.
- » Scupper: 8"
- » GPM: 7-10



27" Sedona Copper Fire Bowl

Maya Planter Bowl

Includes: Bowl Only
(Soil and plants not included.)

24" Bowl
OPT-24SCPO

Size: 24"
Height: 10"
Base: 12"
Soil Usage: 2 ft³

30" Bowl
OPT-30SCPO

Size: 30"
Height: 10"
Base: 15"
Soil Usage: 3 ft³

36" Bowl
OPT-36SCPO

Size: 36"
Height: 12"
Base: 18"
Soil Usage: 5.25 ft³



Maya Planter & Water Bowl

Includes: Bowl, Copper Scupper (¾" Inlet)
(Soil and plants not included)

24" Bowl
OPT-24SCPW

Size: 24"
Height: 10"
Base: 12"
Soil Usage: 2 ft³
Scupper: 8"
GPM: 7-10

30" Bowl
OPT-30SCPW

Size: 30"
Height: 10"
Base: 15"
Soil Usage: 3 ft³
Scupper: 8"
GPM: 7-10

36" Bowl
OPT-36SCPW

Size: 36"
Height: 12"
Base: 18"
Soil Usage: 5.25 ft³
Scupper: 10"
GPM: 7-10

Maya Water Bowl

Includes: Bowl, Copper Spillway
(1 ½" Water Inlet)

24" Bowl
OPT-24SCW

Size: 24"
Height: 10"
Base: 12"
Scupper: 8"
GPM: 7-10

30" Bowl
OPT-30SCW

Size: 30"
Height: 10"
Base: 15"
Scupper: 8"
GPM: 7-10

36" Bowl
OPT-36SCW

Size: 36"
Height: 12"
Base: 18"
Scupper: 10"
GPM: 7-10



Maya Water Bowl - Wide Spill

Includes: Bowl, Copper Spillway
(1 ½" Water Inlet)

24" Bowl
OPT-24SCXW

Size: 24"
Height: 10"
Base: 12"
Scupper: 20"
GPM: 15

30" Bowl
OPT-30SCXW

Size: 30"
Height: 10"
Base: 15"
Scupper: 24"
GPM: 15

36" Bowl
OPT-36SCXW

Size: 36"
Height: 12"
Base: 18"
Scupper: 30"
GPM: 15



Maya Fire Bowl

Includes: Bowl, Fire Pan, Burner, Whistle Free Hose,
Gas Orifice, Mounting Bracket, Lava Rock.

24" Bowl
OPT-103-SQ24
OPT-103-SQ24E12V

Size: 24"
Height: 10"
Base: 12"
Burner: 8"
BTU: 45K
Sugg. Glass: 45 lbs.

30" Bowl
OPT-103-SQ30
OPT-103-SQ30E12V

Size: 30"
Height: 10"
Base: 15"
Burner: 10"
BTU: 65K
Sugg. Glass: 60 lbs.

36" Bowl
OPT-103-SQ36
OPT-103-SQ36E12V

Size: 36"
Height: 12"
Base: 18"
Burner: 10"
BTU: 65K
Sugg. Glass: 90 lbs.



Maya Fire & Water Bowl

Includes: Bowl, Copper Scupper (¾" Inlet) Fire Pan, Burner, Whistle Free Hose, Gas Orifice, Mounting Bracket, Lava Rock.



24" Bowl

OPT-24SCFW
OPT-24SCFWE12V

- » Size: 24"
- » Height: 10"
- » Base: 12"
- » Burner: 8"
- » BTU: 45K
- » Sugg. Glass: 45 lbs.
- » Scupper: 8"
- » GPM: 7-10

30" Bowl

OPT-30SCFW
OPT-30SCFWE12V

- » Size: 30"
- » Height: 10"
- » Base: 15"
- » Burner: 10"
- » BTU: 65K
- » Sugg. Glass: 60 lbs.
- » Scupper: 8"
- » GPM: 7-10

36" Bowl

OPT-36SCFW
OPT-36SCFWE12V

- » Size: 36"
- » Height: 12"
- » Base: 18"
- » Burner: 10"
- » BTU: 65K
- » Sugg. Glass: 90 lbs.
- » Scupper: 10"
- » GPM: 7-10

Maya Fire & Water Bowl - Gravity Spill

Includes: Bowl, Fire Pan, Burner, Whistle Free Hose, Gas Orifice, Mounting Bracket, Lava Rock. (1 ½" Water Inlet)



30" Bowl

OPT-SQ30FANDW
OPT-SQ30FANDWE12V

- » Size: 30"
- » Height: 10"
- » Base: 15"
- » Burner: 10"
- » BTU: 65K
- » Sugg. Glass: 45 lbs.
- » Scupper: 8"
- » GPM: 7-10

36" Bowl

OPT-SQ36FANDW
OPT-SQ36FANDWE12V

- » Size: 36"
- » Height: 12"
- » Base: 18"
- » Burner: 10"
- » BTU: 65K
- » Sugg. Glass: 60 lbs.
- » Scupper: 10"
- » GPM: 7-10

Maya Fire & Water Bowl - Wide Gravity Spill

Includes: Bowl, Fire Pan, Burner, Whistle Free Hose, Gas Orifice, Mounting Bracket, Lava Rock. (1 ½" Water Inlet)



30" Bowl

OPT-SQ30FWWS
OPT-SQ30FWWSE12V

- » Size: 30"
- » Height: 10"
- » Base: 15"
- » Burner: 10"
- » BTU: 65K
- » Sugg. Glass: 45 lbs.
- » Scupper: 8"
- » GPM: 15

36" Bowl

OPT-SQ36FWWS
OPT-SQ36FWWSE12V

- » Size: 36"
- » Height: 12"
- » Base: 18"
- » Burner: 10"
- » BTU: 65K
- » Sugg. Glass: 60 lbs.
- » Scupper: 10"
- » GPM: 15

Maya 4-Way Fire & Water Bowl

Includes: Bowl, Fire Pan, Burner, Whistle Free Hose, Gas Orifice, Mounting Bracket, Lava Rock. (1 ½" Water Inlet)



30" Bowl

OPT-30FW4W
OPT-30FW4WE12V

- » Size: 30"
- » Height: 10"
- » Base: 15"
- » Burner: 8"
- » BTU: 45K
- » Sugg. Glass: 60 lbs.
- » Scupper: 8"
- » GPM: 15

36" Bowl

OPT-36FW4W
OPT-36FW4WE12V

- » Size: 36"
- » Height: 12"
- » Base: 18"
- » Burner: 10"
- » BTU: 65K
- » Sugg. Glass: 90 lbs.
- » Scupper: 10"
- » GPM: 15

Optional Maya Canvas Cover

24" Cover - OPT-BCVR-2424
30" Cover - OPT-BCVR-3030
36" Cover - OPT-BCVR-3636

MAYA & NILE COPPER BOWLS

Linear Maya Fire Bowl

Includes: Bowl, Fire Pan, Burner, Whistle Free Hose, Gas Orifice, Mounting Bracket, Lava Rock.

48" Bowl

OPT-4820MCFO
OPT-4820MCF0E12V

- » Size: 48" x 20"
- » Height: 12"
- » Base: 38" x 10"
- » Burner: 30" Linear
- » BTU: 65K
- » Sugg. Glass: 70lbs.

60" Bowl

OPT-6020MCFO
OPT-6020MCF0E12V

- » Size: 60" x 20"
- » Height: 12"
- » Base: 50" x 10"
- » Burner: 42" Linear
- » BTU: 65K
- » Sugg. Glass: 95 lbs.

72" Bowl

OPT-7220MCFO
OPT-7220MCF0E12V

- » Size: 72" x 20"
- » Height: 12"
- » Base: 62" x 10"
- » Burner: 54" Linear
- » BTU: 65K
- » Sugg. Glass: 110 lbs.



Linear Maya Fire & Water Bowl

Includes: Bowl, Copper Scupper (¾" Inlet) Fire Pan, Burner, Whistle Free Hose, Gas Orifice, Mounting Bracket, Lava Rock.

48" Bowl

OPT-4820MCFW
OPT-4820MCFWE12V

- » Size: 48" x 20"
- » Height: 12"
- » Base: 38" x 10"
- » Burner: 30" Linear
- » BTU: 65K
- » Sugg. Glass: 70 lbs.
- » GPM: 15

60" Bowl

OPT-6020MCFW
OPT-6020MCFWE12V

- » Size: 60" x 20"
- » Height: 12"
- » Base: 50" x 10"
- » Burner: 42" Linear
- » BTU: 65K
- » Sugg. Glass: 95 lbs.
- » GPM: 15

72" Bowl

OPT-7220MCFW
OPT-7220MCFWE12V

- » Size: 72" x 20"
- » Height: 12"
- » Base: 62" x 10"
- » Burner: 54" Linear
- » BTU: 65K
- » Sugg. Glass: 110 lbs.
- » GPM: 15



Nile Fire & Water Bowl

Includes: Bowl, Copper Scupper (¾" Inlet) Fire Pan, Burner, Whistle Free Hose, Gas Orifice, Mounting Bracket, Lava Rock.

30" Bowl

OPT-30NLCPF
OPT-30NLCPF12V

- » Width: 30"
- » Length: 40"
- » Height: 14"
- » Base: 16" x 12"
- » Burner: 18"
- » BTU: 30K
- » GPM: 20

36" Bowl

OPT-36NLCPF
OPT-36NLCPF12V

- » Width: 36"
- » Length: 48"
- » Height: 14"
- » Base: 18" x 15"
- » Burner: 24"
- » BTU: 40K
- » GPM: 20



30" Nile Fire & Water Bowl

31" REMI COPPER BOWL



Remi Planter Bowl

Includes: Bowl Only
(Soil and plants not included.)

OPT-31RCPO

- » Size: 31"
- » Height: 11"
- » Base: 13"
- » Soil Usage: 2.5 ft³



Remi Water Bowl

Includes: Bowl, Copper Spillway,
(1 1/2" Water Inlet)

OPT-31RCWO

- » Size: 31"
- » Height: 11"
- » Base: 13"
- » Scupper: 10"
- » GPM: 7-10

Remi Planter & Water Bowl

Includes: Bowl, Copper Scupper (3/4" Inlet)
(Soil and plants not included)

OPT-31RCPW

- » Size: 31"
- » Height: 11"
- » Base: 13"
- » Soil Usage: 2.5 ft³
- » Scupper: 10"
- » GPM: 7-10



Remi Fire Bowl

Includes: Bowl, Fire Pan, Burner, Whistle
Free Hose, Gas Orifice, Mounting Bracket,
Lava Rock.

OPT-31RCFO
OPT-31RCFOE12V

- » Size: 31"
- » Height: 11"
- » Base: 13"
- » Burner: 10"
- » BTU: 45K
- » Sugg. Glass: 75 lbs.



Remi Fire & Water Bowl

Includes: Bowl, Copper Scupper (3/4" Inlet)
Fire Pan, Burner, Whistle Free Hose, Gas
Orifice, Mounting Bracket, Lava Rock.

OPT-31RCFW
OPT-31RCFWE12V

- » Size: 31"
- » Height: 11"
- » Base: 13"
- » Burner: 10"
- » BTU: 45K
- » Sugg. Glass: 75 lbs.
- » Scupper: 10"
- » GPM: 7-10



Fire & Water Bowl - Gravity Spill

Includes: Bowl, Fire Pan, Burner, Whistle
Free Hose, Gas Orifice, Mounting Bracket,
Lava Rock. (1 1/2" Water Inlet)

OPT-31RCFWGS
OPT-31RCFWGSE12V

- » Size: 31"
- » Height: 11.5"
- » Base: 13"
- » Burner: 10"
- » BTU: 45K
- » Sugg. Glass: 75 lbs.
- » Scupper: 10"
- » GPM: 7-10



All Water Bowls Include The Easy Flow Fitting

All Water Bowls come with easy-flow
water fitting that accommodates a 1 1/2"
water line



Key Valve Upgrade

OPT-KVI

Installed Onto Bowl: Key Valve,
Installation Bracket, & Gas Hoses

Optional Remi Canvas Cover

31" Cover - OPT-BCVR-31R

AVALON COPPER BOWLS



Avalon Water Bowl

Includes: Bowl, Copper Spillway, (1 1/2" Water Inlet)

24" Bowl

OPT-24AVSSWO - Stainless
OPT-24AVCPWO - Copper

- » Size: 24"
- » Height: 10"
- » Base: 12"
- » Scupper: 8"
- » GPM: 7-10

30" Bowl

OPT-30AVSSWO - Stainless
OPT-30AVCPWO - Copper

- » Size: 30"
- » Height: 13"
- » Base: 15"
- » Scupper: 8"
- » GPM: 7-10

36" Bowl

OPT-36AVSSWO - Stainless
OPT-36AVCPWO - Copper

- » Size: 36"
- » Height: 13"
- » Base: 18"
- » Scupper: 10"
- » GPM: 20



Avalon Fire & Water Bowl

Includes: Bowl, Copper Scupper (3/4" Inlet) Fire Pan, Burner, Whistle Free Hose, Gas Orifice, Mounting Bracket, Lava Rock.

24" Bowl

OPT-24AVCPFOW - Copper
OPT-24AVCPFWE12V - Copper
OPT-24AVSSFW - Stainless
OPT-24AVSSFWE12V - Stainless

- » Size: 24"
- » Height: 10"
- » Base: 12"
- » Burner: 8"
- » BTU: 45K
- » Sugg. Glass: 45 lbs.
- » GPM: 7-10

30" Bowl

OPT-30AVCPFOW - Copper
OPT-30AVCPFWE12V - Copper
OPT-30AVSSFW - Stainless
OPT-30AVSSFWE12V - Stainless

- » Size: 30"
- » Height: 13"
- » Base: 15"
- » Burner: 10"
- » BTU: 65K
- » Sugg. Glass: 60 lbs.
- » GPM: 7-10

36" Bowl

OPT-36AVCPFOW - Copper
OPT-36AVCPFWE12V - Copper
OPT-36AVSSFW - Stainless
OPT-36AVSSFWE12V - Stainless

- » Size: 36"
- » Height: 13"
- » Base: 18"
- » Burner: 10"
- » BTU: 65K
- » Sugg. Glass: 90 lbs.
- » GPM: 7-10



All Water Bowls Include The Easy Flow Fitting

All Water Bowls come with easy-flow water fitting that accommodates a 1 1/2" water line



Key Valve Upgrade

OPT-KVI

Installed Onto Bowl, Installation Bracket, & Gas Hoses

Optional Avalon Canvas Cover

24" Cover - OPT-BCVR-2424
30" Cover - OPT-BCVR-3030
36" Cover - OPT-BCVR-3636



Avalon Fire Bowl

Includes: Bowl, Fire Pan, Burner, Whistle Free Hose, Gas Orifice, Mounting Bracket, Lava Rock.

24" Bowl

OPT-24AVCPF - Copper
OPT-24AVCPFE12V - Copper
OPT-24AVSSF - Stainless
OPT-24AVSSFE12V - Stainless

- » Size: 24"
- » Height: 10"
- » Base: 12"
- » Burner: 8"
- » BTU: 45K
- » Sugg. Glass: 45 lbs.

30" Bowl

OPT-30AVCPF - Copper
OPT-30AVCPFE12V - Copper
OPT-30AVSSF - Stainless
OPT-30AVSSFE12V - Stainless

- » Size: 30"
- » Height: 13"
- » Base: 15"
- » Burner: 10"
- » BTU: 65K
- » Sugg. Glass: 60 lbs.

36" Bowl

OPT-36AVCPF - Copper
OPT-36AVCPFE12V - Copper
OPT-36AVSSF - Stainless
OPT-36AVSSFE12V - Stainless

- » Size: 36"
- » Height: 13"
- » Base: 18"
- » Burner: 10"
- » BTU: 65K
- » Sugg. Glass: 90 lbs.

CAZO BOWLS - POWDER COAT FINISH



24" WHITE

Cazo Planter Bowl

Includes: Bowl Only
(Soil and plants not included.)

24" Bowl
OPT-R24PCPO

- » Size: 24"
- » Height: 10"
- » Base: 10"
- » Soil Usage: 1.5 ft³

30" Bowl
OPT-R30PCPO

- » Size: 30"
- » Height: 12"
- » Base: 16"
- » Soil Usage: 3 ft³

36" Bowl
OPT-R36PCPO

- » Size: 36"
- » Height: 12"
- » Base: 20"
- » Soil Usage: 4.5 ft³

Cazo Planter & Water Bowl

Includes: Bowl, Copper Scupper (¾" Inlet)
(Soil and plants not included)

24" Bowl
OPT-R24PCPW

- » Size: 24"
- » Height: 10"
- » Base: 10"
- » Soil Usage: 1.5 ft³
- » Scupper: 8"
- » GPM: 7-10

30" Bowl
OPT-R30PCPW

- » Size: 30"
- » Height: 12"
- » Base: 16"
- » Soil Usage: 3 ft³
- » Scupper: 8"
- » GPM: 7-10

36" Bowl
OPT-R36PCPW

- » Size: 36"
- » Height: 12"
- » Base: 20"
- » Soil Usage: 4.5 ft³
- » Scupper: 10"
- » GPM: 7-10



24" SILVER VEIN

Cazo Water Bowl

Includes: Bowl, Copper Spillway,
(1 ½" Water Inlet)

24" Bowl
OPT-24PCWO

- » Size: 24"
- » Height: 10"
- » Base: 10"
- » Scupper: 8"
- » GPM: 7-10

30" Bowl
OPT-30PCWO

- » Size: 30"
- » Height: 12"
- » Base: 16"
- » Scupper: 8"
- » GPM: 7-10

36" Bowl
OPT-36PCWO

- » Size: 36"
- » Height: 12"
- » Base: 20"
- » Scupper: 10"
- » GPM: 7-10

POWDER COAT COLOR OPTIONS

When ordering, specify the concrete color by adding the color code to the end of the Part #. **Example:** 27" Brown Sedona Water Bowl = OPT-27RWO-BRN

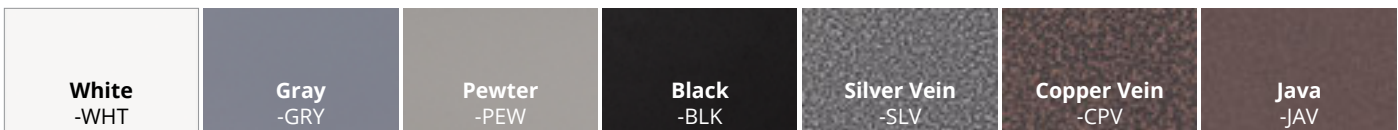

All Water Bowls Include The Easy Flow Fitting

All Water Bowls come with easy-flow water fitting that accommodates a 1 ½" water line



Key Valve Upgrade

OPT-KVI

Installed Onto Bowl: Key Valve, Installation Bracket, & Gas Hoses

Optional Cazo Canvas Cover

24" Cover - OPT-BCVR-24R
30" Cover - OPT-BCVR-30R
36" Cover - OPT-BCVR-36R

CAZO BOWLS - POWDER COAT FINISH



24" COPPER VEIN

Cazo Fire Bowl

Includes: Bowl, Fire Pan, Burner, Whistle Free Hose, Gas Orifice, Mounting Bracket, Lava Rock.

24" Bowl

OPT-R24PCFO
OPT-R24PCFOE12V

- » Size: 24"
- » Height: 10"
- » Base: 10"
- » Burner: 8"
- » BTU: 45K
- » Sugg. Glass: 20 lbs.

30" Bowl

OPT-R30PCFO
OPT-R30PCFOE12V

- » Size: 30"
- » Height: 12"
- » Base: 16"
- » Burner: 10"
- » BTU: 65K
- » Sugg. Glass: 35lbs.

36" Bowl

OPT-R36PCFO
OPT-R36PCFOE12V

- » Size: 36"
- » Height: 12"
- » Base: 20"
- » Burner: 10"
- » BTU: 65K
- » Sugg. Glass: 50 lbs.



24" GRAY

Cazo Fire & Water Bowl

Includes: Bowl, Copper Scupper (¾" Inlet) Fire Pan, Burner, Whistle Free Hose, Gas Orifice, Mounting Bracket, Lava Rock.

24" Bowl

OPT-R24PCFW
OPT-R24PCFWE12V

- » Size: 24"
- » Height: 10"
- » Base: 10"
- » Burner: 8"
- » BTU: 45K
- » Sugg. Glass: 20 lbs.
- » Scupper: 8"
- » GPM: 7-10

30" Bowl

OPT-R30PCFW
OPT-R30PCFWE12V

- » Size: 30"
- » Height: 12"
- » Base: 16"
- » Burner: 10"
- » BTU: 65K
- » Sugg. Glass: 35 lbs.
- » Scupper: 8"
- » GPM: 7-10

36" Bowl

OPT-R36PCFW
OPT-R36PCFWE12V

- » Size: 36"
- » Height: 12"
- » Base: 20"
- » Burner: 10"
- » BTU: 65K
- » Sugg. Glass: 50 lbs.
- » Scupper: 10"
- » GPM: 7-10

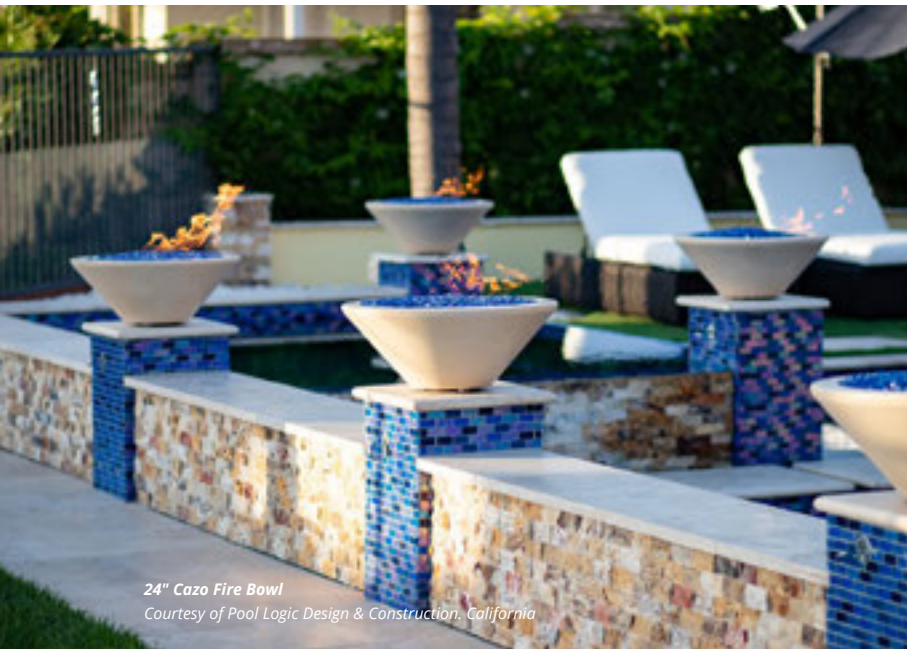

24" Cazo Fire Bowl
Courtesy of Pool Logic Design & Construction, California

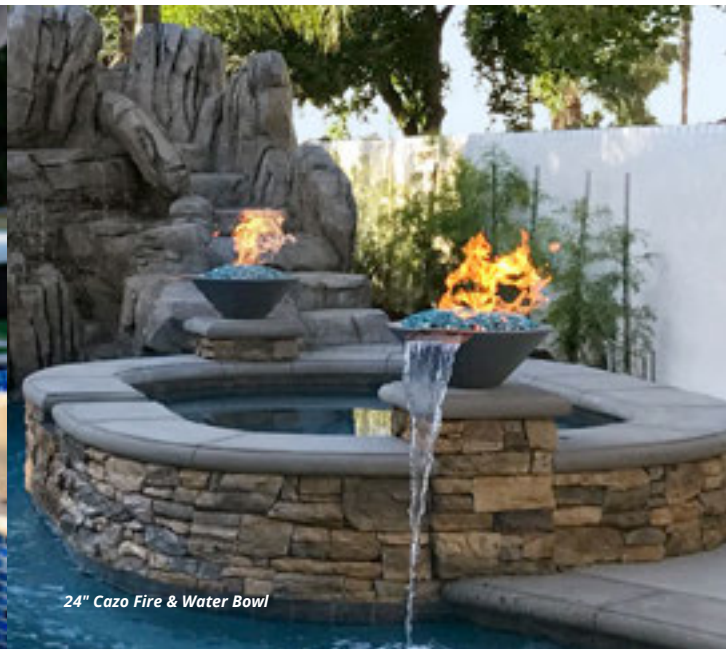

24" Cazo Fire & Water Bowl

SEDONA BOWLS - POWDER COAT FINISH

Sedona Planter Bowl

Includes: Bowl Only
(Soil and plants not included.)

27" Bowl
OPT-27RPCPO

- » Size: 27"
- » Height: 10"
- » Base: 12"
- » Soil Usage: 1.5 ft³



27" GRAY

Sedona Planter & Water Bowl

Includes: Bowl, Copper Scupper (¾" Inlet)
(Soil and plants not included)

27" Bowl
OPT-27RPCPW

- » Size: 27"
- » Height: 10"
- » Base: 12"
- » Soil Usage: 1.5 ft³
- » Scupper: 8"
- » GPM: 7-10



27" BLACK

Sedona Water Bowl

Includes: Bowl, Copper Spillway,
(1 ½" Water Inlet)

27" Bowl
OPT-27RPCWO

- » Size: 27"
- » Height: 10"
- » Base: 12"
- » Scupper: 8"
- » GPM: 7-10



27" COPPER VEIN

Sedona Fire Bowl

Includes: Bowl, Fire Pan, Burner, Whistle Free Hose,
Gas Orifice, Mounting Bracket, Lava Rock.

27" Bowl
OPT-27RPCFO
OPT-27RPCFOE12V

- » Size: 27"
- » Height: 10"
- » Base: 12"
- » Burner: 8"
- » BTU: 45K
- » Sugg. Glass: 20 lbs.

POWDER COAT COLOR OPTIONS

When ordering, specify the concrete color by adding the color code to the end of the Part #. **Example:** 27" Brown Sedona Water Bowl = OPT-27RWO-BRN

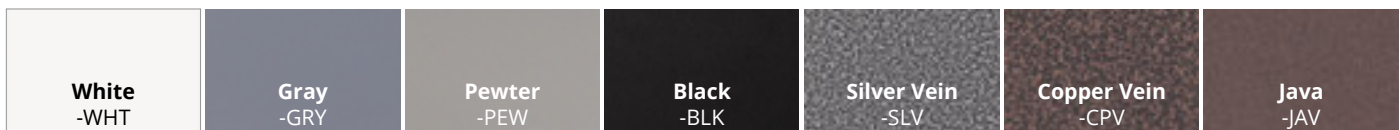

SEDONA BOWLS - POWDER COAT FINISH



27" LIMESTONE

Sedona Fire & Water Bowl

Includes: Bowl, Copper Scupper (¾" Inlet) Fire Pan, Burner, Whistle Free Hose, Gas Orifice, Mounting Bracket, Lava Rock.

27" Bowl
OPT-27RPCFW
OPT-27RPCFWE12V

- » Size: 27"
- » Height: 10"
- » Base: 12"
- » Burner: 8"
- » BTU: 45K
- » Sugg. Glass: 20 lbs.
- » Scupper: 8"
- » GPM: 7-10



All Water Bowls Include The Easy Flow Fitting

All Water Bowls come with easy-flow water fitting that accommodates a 1 ½" water line



Key Valve Upgrade

OPT-KVI

Installed Onto Bowl: Key Valve, Installation Bracket, & Gas Hoses

Optional Sedona Canvas Cover

27" Cover - OPT-BCVR-27R



27" Sedona Fire Bowl in Copper Vein Finish



MAYA BOWLS - POWDER COAT FINISH



24" GRAY

Maya Planter Bowl

Includes: Bowl Only
(Soil and plants not included.)

24" Bowl
OPT-245QPCPO

- » Size: 24"
- » Height: 10"
- » Base: 12"
- » Soil Usage: 2 ft³

30" Bowl
OPT-305QPCPO

- » Size: 30"
- » Height: 10"
- » Base: 15"
- » Soil Usage: 3 ft³

36" Bowl
OPT-365QPCPO

- » Size: 36"
- » Height: 12"
- » Base: 18"
- » Soil Usage: 5.25 ft³

Maya Planter & Water Bowl

Includes: Bowl, Copper Scupper (¾" Inlet)
(Soil and plants not included)

24" Bowl
OPT-245QPCPW

- » Size: 24"
- » Height: 10"
- » Base: 12"
- » Soil Usage: 2 ft³
- » Scupper: 8"
- » GPM: 7-10

30" Bowl
OPT-305QPCPW

- » Size: 30"
- » Height: 10"
- » Base: 15"
- » Soil Usage: 3 ft³
- » Scupper: 8"
- » GPM: 7-10

36" Bowl
OPT-365QPCPW

- » Size: 36"
- » Height: 12"
- » Base: 18"
- » Soil Usage: 5.25 ft³
- » Scupper: 10"
- » GPM: 7-10



24" BLACK

Maya Water Bowl

Includes: Bowl, Copper Spillway,
(1 ½" Water Inlet)

24" Bowl
OPT-245QPCWO

- » Size: 24"
- » Height: 10"
- » Base: 12"
- » Scupper: 8"
- » GPM: 7-10

30" Bowl
OPT-305QPCWO

- » Size: 30"
- » Height: 10"
- » Base: 15"
- » Scupper: 8"
- » GPM: 7-10

36" Bowl
OPT-365QPCWO

- » Size: 36"
- » Height: 12"
- » Base: 18"
- » Scupper: 10"
- » GPM: 7-10

POWDER COAT COLOR OPTIONS

When ordering, specify the concrete color by adding the color code to the end of the Part #. **Example:** 27" Brown Sedona Water Bowl = OPT-27RWO-BRN

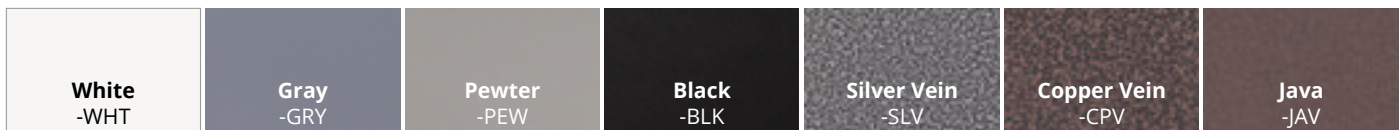

All Water Bowls Include The Easy Flow Fitting

All Water Bowls come with easy-flow water fitting that accommodates a 1 ½" water line



Key Valve Upgrade

OPT-KVI

Installed Onto Bowl; Key Valve, Installation Bracket, & Gas Hoses

Optional Maya Canvas Cover

24" Cover - OPT-BCVR-2424
30" Cover - OPT-BCVR-3030
36" Cover - OPT-BCVR-3636

MAYA BOWLS - POWDER COAT FINISH



24" WHITE

Maya Fire Bowl



Includes: Bowl, Fire Pan, Burner, Whistle Free Hose, Gas Orifice, Mounting Bracket, Lava Rock.

24" Bowl

OPT-24SQPCFO
OPT-24SQPCFOE12V

- » Size: 24"
- » Height: 10"
- » Base: 12"
- » Burner: 8"
- » BTU: 45K
- » Sugg. Glass: 45 lbs.

30" Bowl

OPT-30SQPCFO
OPT-30SQPCFOE12V

- » Size: 30"
- » Height: 10"
- » Base: 15"
- » Burner: 10"
- » BTU: 65K
- » Sugg. Glass: 60 lbs.

36" Bowl

OPT-36SQPCFO
OPT-36SQPCFOE12V

- » Size: 36"
- » Height: 12"
- » Base: 18"
- » Burner: 10"
- » BTU: 65K
- » Sugg. Glass: 90 lbs.



24" COPPER
VEIN

Maya Fire & Water Bowl

Includes: Bowl, Copper Scupper (3/4" Inlet) Fire Pan, Burner, Whistle Free Hose, Gas Orifice, Mounting Bracket, Lava Rock.

24" Bowl

OPT-24SQPCFW
OPT-24SQPCFWE12V

- » Size: 24"
- » Height: 10"
- » Base: 12"
- » Burner: 8"
- » BTU: 45K
- » Sugg. Glass: 45 lbs.
- » Scupper: 8"
- » GPM: 7-10

30" Bowl

OPT-30SQPCFW
OPT-30SQPCFWE12V

- » Size: 30"
- » Height: 10"
- » Base: 15"
- » Burner: 10"
- » BTU: 65K
- » Sugg. Glass: 60 lbs.
- » Scupper: 8"
- » GPM: 7-10

36" Bowl

OPT-36SQPCFW
OPT-36SQPCFWE12V

- » Size: 36"
- » Height: 12"
- » Base: 18"
- » Burner: 10"
- » BTU: 65K
- » Sugg. Glass: 90 lbs.
- » Scupper: 10"
- » GPM: 7-10



30" Maya Wide Spill Water Bowl



30" Maya Fire Bowl

INTRODUCING THE FLAME SENSE FOR BOWLS & FIRE PITS

The Flame Sense valve is the solution for a certified match lit unit with added safety features and CSA certification. It does not require any batteries or electrical connections so installation is easier and simpler than ever. This unit is compatible with majority of T.O.P's fire features.



◇ **Thermopile Technology**

The thermopile sensors in this unit is the defining factor of safety. By using a thermopile sensor this unit will not release gas without a flame being present.

◇ **Automatic Flame Shut Off**

By using the same thermopile technology, the unit is able to sense if a flame has gone out and automatically turn itself off. This is great in case a sudden gust of wind or rainfall extinguishes your flames.

◇ **Electricity Free**

The unit does not use batteries or electrical current to operate. This makes it safe to install near bodies of water, eliminates the need to run electrical lines and eases up installation.

◇ **Easy Installation**

The valve uses two simple gas in & gas out inlets. Simply connect two gas hoses with flared fittings to get this unit running.

◇ **Weather Tested**

Proven to operate properly in mild wind, rain & snow.

◇ **Compact Construction**

The small construction allows it to be installed in tight spaces.

◇ **1 Year Limited Warranty**

Covers all components of the Electronic Ignition System

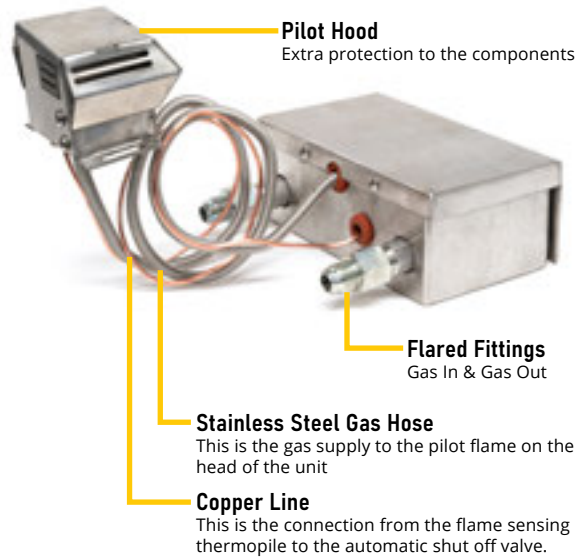

WHAT'S INCLUDED IN YOUR BOWL?

MATCH LIT FIRE BOWLS

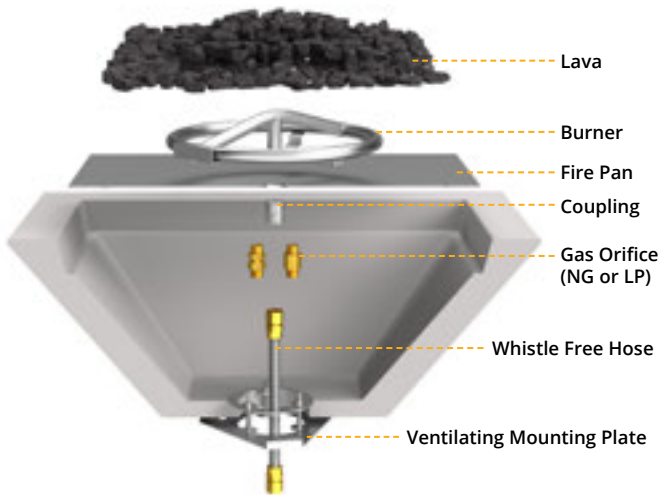

MATCH LIT FIRE & WATER BOWLS

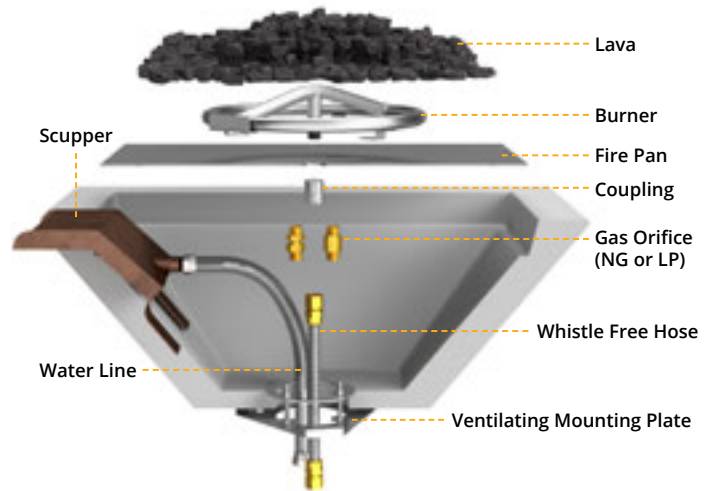

12V/110V FIRE BOWLS

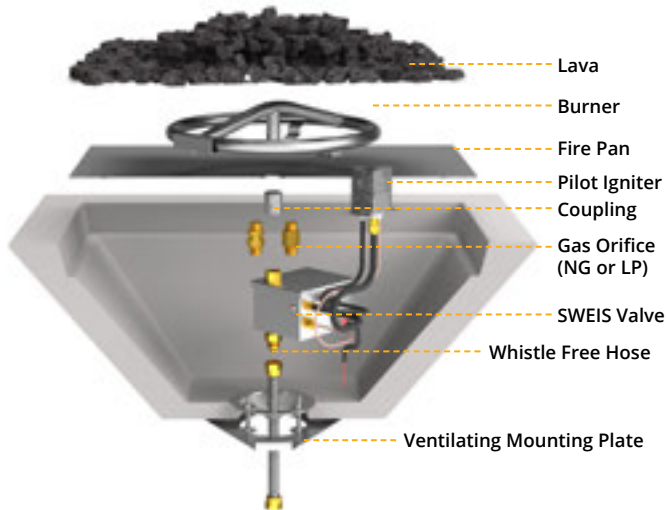

12V/110V FIRE & WATER BOWLS

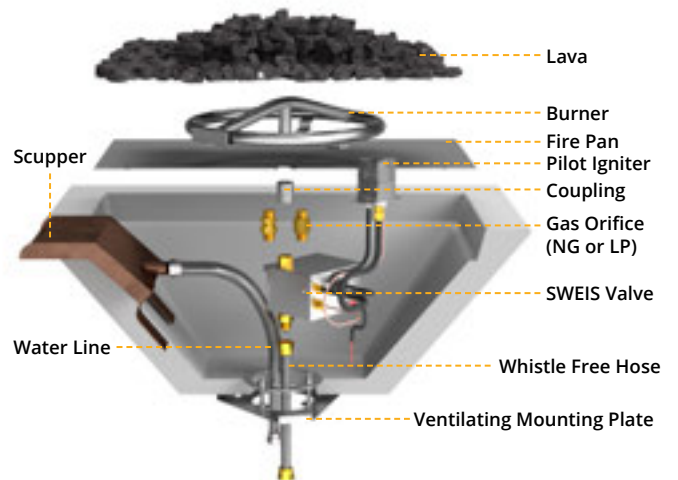

Liquid Propane

Liquid Propane applications require a Brass Air Mixer Orifice. This orifice integrates air into the propane for a cleaner burning flame. This prevents soot from being created and staining the unit and other surroundings.

Natural Gas

Natural Gas applications come with a brass orifice mounted directly underneath the burner. Key Valves must be mounted within arms reach of the burner.

NOTE: Key Valves may be installed onto the face of the bowl. To have your bowls shipped like this for an addi-

tional fee, add OPT-KVI to your order (Includes Key Valve, Whistle Free Hose & Installation)



Mounting Brackets

All fire bowls come shipped with a mounting bracket. This mounting bracket provides ventilation and a secure mount.

WARRANTY IS VOID IF THE MOUNTING BRACKET IS NOT INSTALLED.

Propane & Glass

It is not recommended to use any sort of fire glass or glass pebbles in Liquid Propane applications. Propane is 1.5x heavier than air and sinks, decorative glass is dense and may not allow the propane to properly rise. Propane may collect and pool under the surface of the glass or inside the enclosure creating a potentially dangerous situation.