

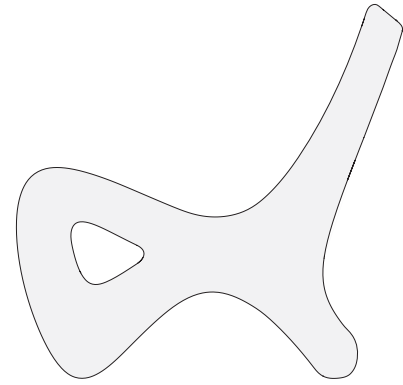

# AUTOGRAPH CHAIR



## THANK YOU FOR YOUR PURCHASE

Our team of expert designers, craftsmen, and pool industry professionals have obsessed over every detail of your Autograph Chair. From concept to delivery, every decision was made with you in mind. Sweating the smallest things is our goal, so you can enjoy the big things that matter - making meaningful moments.

Your outdoor experience comes with peace of mind. That's why we pride ourselves on long-lasting, low-maintenance outdoor living, and we back it up with a best-in-class warranty.

## BEFORE YOU START

For fun and effective setup, prepare to get wet. Throw on your bathing suit, gather your setup materials and jump in!

## IMPORTANT NOTE

The Autograph Chair is designed for water depths up to 12" or on-deck.

## REQUIRED TOOLS



FLATHEAD SCREWDRIVER

## YOUR POOL

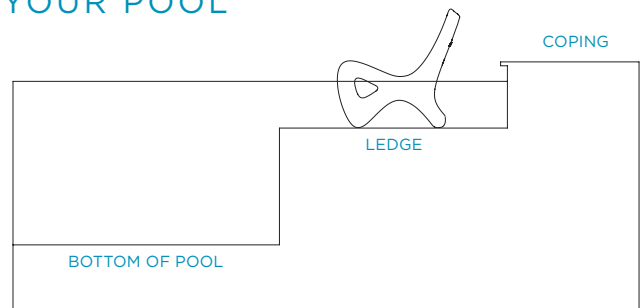

Official Distributor  
800-971-1442 |  
info@aquablumosaics.com  
www.AquaBluMosaics.com

**STEP 1:** Place the Autograph Chair upside down in the shallow end of your pool. Remove the plugs from the front and rear fill holes with a flathead screwdriver.

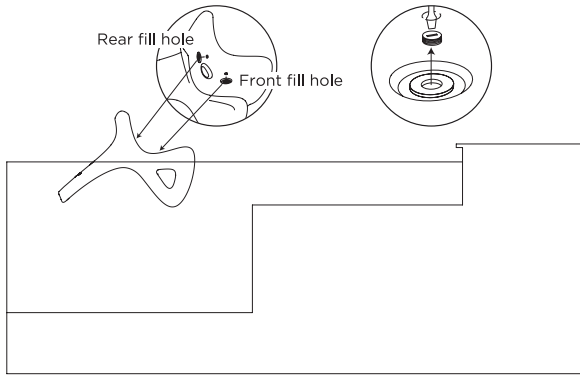

**STEP 2:** Submerge the front fill hole first and allow water to start filling the chair. You will hear the cavity filling from the rear fill hole.

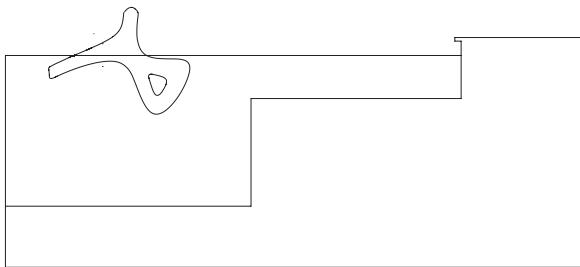

**STEP 3:** Allow the chair to submerge. Water will enter quickly. Once the entire chair is filled, rock it several times front to back to release any remaining air.

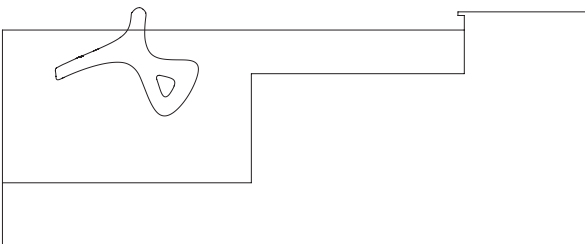

**STEP 4:** Keep the chair submerged and screw the plugs back in. Handle plugs carefully to avoid cross-threading them.

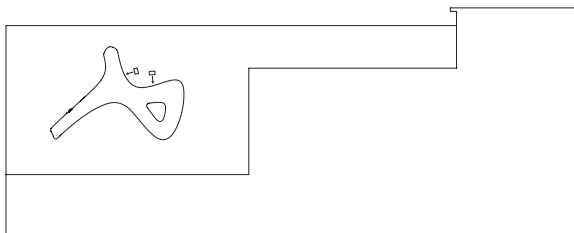

**STEP 5:** Turn the Autograph Chair right side up and position the base on the edge of the ledge. Carefully slide it into its final location.

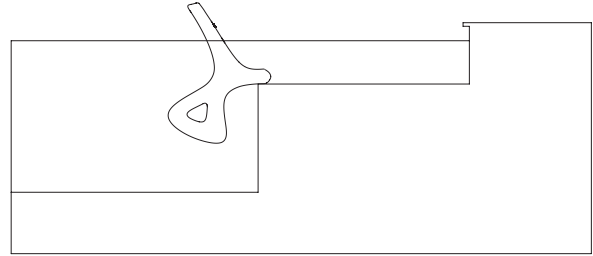

**STEP 6:** Enjoy your new Autograph Chair and begin creating life's most meaningful moments. Tag us for a chance to be featured!

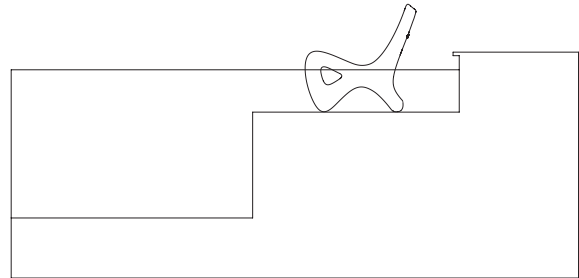

## CARE AND MAINTENANCE

### ROUTINE CLEANING

Clean with a soft cloth, microfiber towel, or spray down with a water hose. For a deeper clean, use mild soap and water with a soft bristle brush.

### POWER WASHING

Use caution to avoid etching your Autograph Chair. Start with a very low PSI at least 3 feet away from furniture, and test on the under side before moving closer. Move closer or increase PSI gradually and with caution until dirt is removed. Check often to ensure no etching is left on furniture.



Official Distributor  
800-971-1442 |  
info@aquablumosaics.com  
www.AquaBluMosaics.com