

Series Includes:

CAC503

CAC507

CAC509

CAC522



## WELCOME

If you have questions about your CVap equipment, please contact your corporate office, local distributor, or Winston's Customer Care Center at 1.800.234.5286 or 1.502.495.5400, or e-mail us at [customercare@winstonind.com](mailto:customercare@winstonind.com).

## CONTACT INFORMATION:

Internet: [www.winstonfoodservice.com](http://www.winstonfoodservice.com)  
E-mail: [customercare@winstonind.com](mailto:customercare@winstonind.com)  
Phone: 1.800.234.5286 | 1.502.495.5400  
Fax: 1.502.495.5458  
Mail: 2345 Carton Drive | Louisville, KY 40299 USA

## CONTENTS

Important Safety Information	2-3
General Installation	3-5
How Your CVap Works	6-11
Daily Cleaning Procedure	12-13
Warranty & Terms and Conditions	14

## WARNINGS AND INSTALLATION INSTRUCTIONS

As is the case with most cooking equipment, your CVap oven should be used with caution. Please read the following warnings to avoid potential injuries.

### **DANGER: Electrical Hazard**

Can cause serious injury or death >> Do not attempt to service this equipment unless you are a licensed electrician or trained servicer.

Because this equipment utilizes high voltage, it should only be installed and serviced by a licensed electrician or trained servicer. Attempting to install or service the equipment yourself could result in serious, potentially fatal injuries.

If an electrical shock is felt when touching equipment, shut off power immediately (pull cord or turn off circuit breaker) and call a trained servicer for repair. Failure to do so could result in serious, potentially fatal injuries.

Always turn power switch off any time equipment is not in use.

### **WARNING: Burn Hazard**

Can cause serious injury >> Avoid heated vapor when opening or closing cabinet door.

This equipment utilizes heated water vapor, which transfers heat much more quickly and efficiently than dry air of the same temperature. Use caution when opening doors or reaching into the equipment, as heated vapor can quickly cause burns.

### **WARNING: Contamination Hazard**

Can cause serious illness or damage to equipment >> Clean equipment daily to avoid potential contamination hazard.

Clean equipment daily to prevent buildup of food residue or chlorides, which can also damage stainless steel and contaminate food. Failure to follow proper cleaning procedures can void your warranty.

Prior to using equipment for the first time, perform the daily cleaning procedure listed on page 12-13.

### **CAUTION: Electrical Hazard**

Can cause injury >> Do not connect equipment to an external switching device.

In order to avoid a hazard due to inadvertent resetting of the thermal cutout, this appliance must not be supplied through an external switching device, such as a timer, or connected to a circuit that is regularly switched on and off by the utility.

### **CAUTION: Burn Hazard**

Can cause injury >> Allow 30 minutes for equipment to cool before attempting to clean.

Always allow equipment to cool before cleaning to avoid potential burns.



**! CAUTION: High Temperature & Grease Hazard** Can cause damage to equipment >> Avoid placing equipment near high heat or in grease-laden atmosphere.

Do not place equipment in areas where air temperature exceeds 100°F (38°C). A heat shield may be required to prevent heat exposure and grease-laden vapors from affecting the equipment if near heat, vapor, or grease generating devices (such as grills, steamers, ovens, etc.). Excess heat and grease inside the equipment cavities may cause electrical components to fail.

## WATER FILL PROCEDURE

### Water Supply

In order to operate properly, the evaporator in this oven must be filled with clean, potable water. Hardware is included to connect the oven to a copper line in your facility's water system. If your facility has plastic or galvanized pipes, contact a licensed plumber to connect the water supply. Equipment should be installed to comply with applicable federal, state, or local plumbing codes.

**Equipment with automatic water fill systems are to be installed with adequate backflow protection to comply with federal, state, and local codes.**

As water evaporates, any minerals in the water will deposit on the surface of the evaporator. These mineral deposits will inhibit the transfer of heat. Deposits can also degrade and damage stainless steel. The best way to avoid mineral deposits is to clean the equipment daily. It is also advisable to contact your water utility for advice on minimizing deposit buildup.

For locations with hard water, add one tablespoon (15ml) of white vinegar or lemon juice to water to help minimize scale buildup. Please consider contacting your local water authority to obtain advice on possible water treatment to protect the appliance. Some water supplies are high enough in chemical content to be capable of damaging stainless steel (if used untreated). The evaporation process can concentrate the chemicals in the water to a level which could cause a damaging reaction with the stainless steel.

## INSTALLING AUTO WATER FILL

Insert tubing and push fully into the connector. (Reference drawing on this page.) Once seated, try to pull the tubing out of the connector so that the capture ring comes out (about 1/16" (1.6mm)) and the tubing cannot be removed.

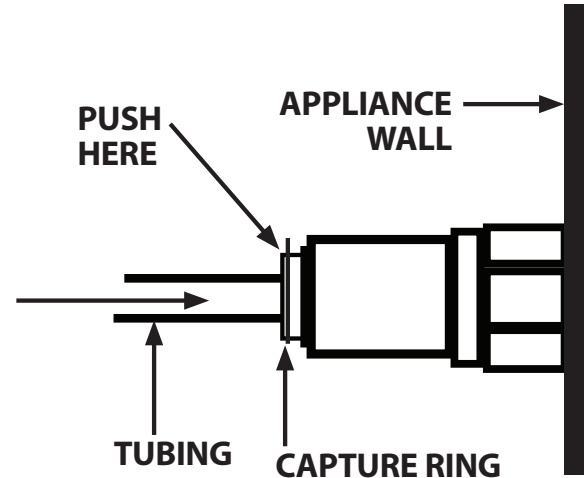

**The maximum incoming water temperature may not exceed 140°F (60°C) and the incoming water pressure must be between 20 and 150 psi (1.4 Kgf/cm<sup>2</sup> to 10.5 Kgf/cm<sup>2</sup> (kilogram-force per sq. centimeter)).**

**! CAUTION: High Temperature**

**Hazard** Can cause damage to equipment >> Fill evaporator with water prior to turning power on, and do not allow evaporator to run dry.

**CAUTION: Equipment with auto water fill systems MUST NOT BE ALLOWED TO RUN DRY. Heat damage to the water valve may result.**

It is the responsibility of the owner and installer to make sure that installation complies with all applicable local and state plumbing codes.

## ELECTRICAL

The equipment is shipped from the factory with a 84" (2134mm) (minimum) power cord and plug. Refer to the table below to determine the correct electrical outlet. It may be necessary to hire a licensed electrician to install the correct outlet or wiring. Winston does not recommend wiring the unit direct.

## VENTILATION REQUIREMENTS

**Ventilation clearances** - To operate properly, the Cook & Hold oven will need sufficient space for air circulation. Allow at least 2" (51mm) clearance on all sides of the oven, particularly around ventilation holes. Care should be taken to prevent placing the oven close to anything combustible. It must be installed with its supplied legs, feet, or casters. Half size equipment may be stacked upon each other using only a Winston supplied stacking kit and following the instructions enclosed with the kit. Your warranty may be void if you do not adhere to these ventilation requirements.

---

 **CAUTION: High Temperature & Grease Hazard** Can cause damage to equipment >>  
Avoid placing equipment near high heat or in grease-laden atmosphere.

---

Do not place equipment in an area where air temperatures around the equipment exceed 100°F (38°C). A heat shield may be required to prevent excessive heat exposure and grease laden vapors from affecting the equipment if adjacent to heat, vapor, or grease generating devices (such as grills, steamers, ovens, etc.). Excess heat and grease inside the equipment cavities may cause electrical components to fail.

**Vent hood** - Generally this equipment does not need to be installed under a mechanical ventilation system (vent hood). Check local health and fire codes for specific requirements.

## COMPONENT IDENTIFICATION



1. **Microprocessor Controller** allows operator to program doneness, browning, and cook time.
2. **Power Switch** allows operator to turn electrical power on and off.
3. **Food Chamber** cooking cavity where the dual heat system combines to create the perfect cooking environment.
4. **Door & Latch** can be reversed on site.
5. **Door Gasket** seals food chamber against heat or vapor loss.
6. **Evaporator and Heater** (not visible) supply vapor atmosphere to the food chamber by heating water within the evaporator.
7. **Drain Valve** enables operator to drain evaporator, to perform daily cleaning.
8. **Bottom Cover** (not visible) provides service access.
9. **Top Cover** provides service access.
10. **Control Escutcheon** is removable for servicing or replacing microprocessor.
11. **Side Panels** support insulation and form outside of oven.
12. **Adjustable Rack Support** supports racks onto which food is placed.
13. **Rack Support Bracket** receives rack support.
14. **Air Heaters** (not visible) supply air heat for food texture control.
15. **Drain Trough** carries water that has condensed onto door back to evaporator.
16. **Name Plate** identifies model and serial number—important for servicing and parts orders. Plate also displays electrical data.
17. **Castors** are non-locking in the back; front are locking.

## CONTROLS - SILVER EDITION

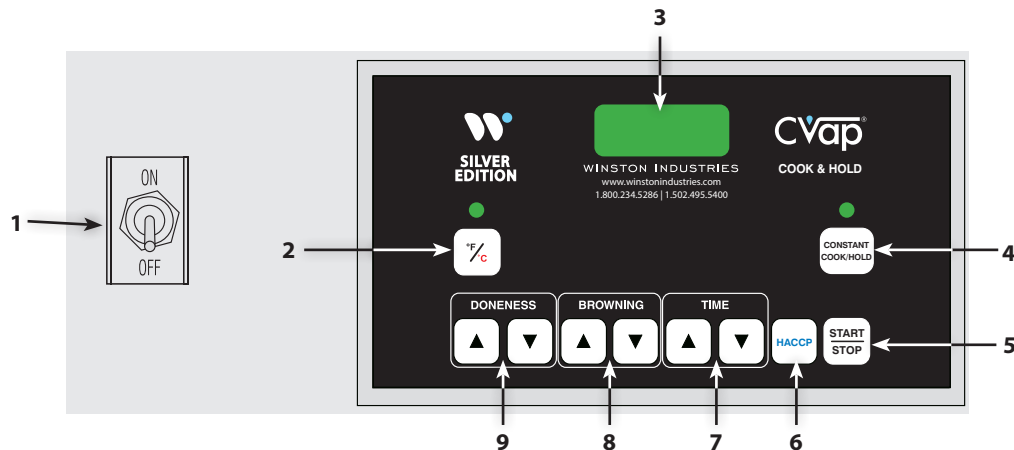

1. **Power Switch** controls electrical power to the oven.
2. **F°/C° Button** is used to switch oven display between Fahrenheit and Centigrade temperature scales.
3. **Digital LED Readout** displays chosen setpoints for doneness, browning, and cook time as the oven is programmed. After pressing Start/Stop button, the display indicates the remaining time in each portion of the cooking process.
4. **Constant Cook & Hold Button** allows operator to manually override High Yield Cooking for personalized cooking or holding.
5. **Start/Stop Button** is used to start or stop the timed cooking process.
6. **HACCP Button** enables user to check current HACCP-relevant conditions inside the oven. Press once to read water (evaporator) temperature. Press again within five seconds to read differential air temperature (the difference between the air temperature and the water temperature). Press again within five seconds to read the actual air (oven) temperature. The LED readout will revert back to default display after five seconds of inactivity.
7. **Time Up (▲) and Down (▼) Buttons** are utilized to set the cooking time (up to 24 hours).
8. **Browning Up (▲) and Down (▼) Buttons** allow selection of the degree of browning (using a 0 to 10 scale).
9. **Doneness Up (▲) and Down (▼) Buttons** allow selection of the final food temperature (from 90 to 200°F (32 to 93°C)).



## CONTROLS - GOLD EDITION

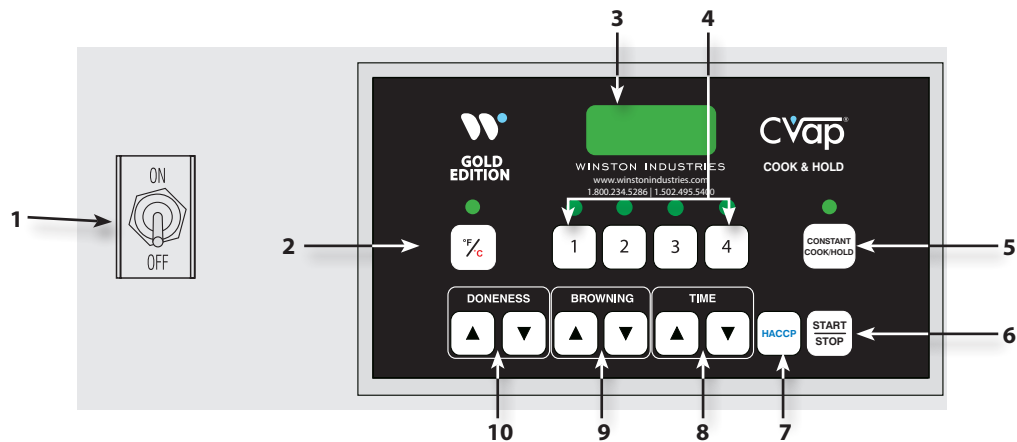

1. **Power Switch** controls electrical power to the oven.
2. **F°/C° Button** is used to switch oven display between Fahrenheit and Centigrade temperature scales.
3. **Digital LED Readout** displays chosen setpoints for doneness, browning, and cook time as the oven is programmed. After pressing Start/Stop button, the display indicates the remaining time in each portion of the cooking process.
4. **Programmable Channels** allow user to program and save specific setpoints for future use.
5. **Constant Cook & Hold Button** allows user to manually override High Yield Cooking for personalized cooking or holding.
6. **Start/Stop Button** is used to start or stop the timed cooking process.
7. **HACCP Button** enables user to check current HACCP-relevant conditions inside the oven. Press once to read water (evaporator) temperature. Press again within five seconds to read differential air temperature (the difference between the air and water temperatures). Press again within five seconds to read the actual air (oven) temperature. The LED readout reverts back to default display after five seconds of inactivity.
8. **Time Up (▲) and Down (▼) Buttons** are utilized to set the cooking time (up to 24 hours).
9. **Browning Up (▲) and Down (▼) Buttons** allow selection of the degree of browning (using a 0 to 10 scale).
10. **Doneness Up (▲) and Down (▼) Buttons** allow selection of the final food temperature (from 90° to 200°F (32 to 93°C)).

## HOW IS THE CVAP COOK & HOLD OVEN DIFFERENT?

The Winston CVap® Cook & Hold oven gives you more control over food quality than other ovens or combis. It allows you to determine whether cooking time or final yield is more important, and doesn't force you to sacrifice quality for either. The following is a brief description of this unit's unique features.

### High Yield Cycle

The High Yield Cycle gives you the maximum possible yield from your foods. Once you have programmed the desired final temperature and degree of browning, the microprocessor automatically determines the best heat curve to achieve the highest yield possible.

### Constant Cook & Hold Cycle

The Constant Cook & Hold Cycle allows you to manually override the High Yield cook cycle while automatically predetermining optimal holding temperatures.

## MICROPROCESSOR CONTROLLED PROCESSES

### Cook Cycle

The CVap Cook & Hold oven utilizes a dual heat system to cook foods to precise doneness, while maintaining high yield. After doneness temperature, degree of browning, and cook time are chosen and START/STOP is pressed, the microprocessor takes over control of the two heat input systems until the end of the serving period.

### Hold Cycle

The cooking process is followed by a timed cycle to meet the requirements of FDA regulations pertaining to food safety in the 120° to 157°F (49° to 69°C) range. If doneness temperature is set at 130°F (54°C), the minimum hold time is 121 minutes; 135°F (57°C), 37 minutes; 140°F (60°C), 12 minutes; 150°F (66°C), two minutes; 151° to 157°F (66° to 69°C), one minute. If doneness temperature is set at 158°F (70°C) or higher, there is no FDA requirement for holding time. This data is programmed in the microprocessor and requires no action by the operator.

### Sell Cycle

The microprocessor automatically chooses the right dual heat combination to hold foods without quality loss for hours while serving. The automatic hold feature requires no action from the operator, freeing up labor.

**WARNING: Contamination Hazard**  
Can cause serious illness >> Clean equipment prior to first use to remove traces of industrial chemicals and oils.

Prior to using equipment for the first time, perform the daily cleaning procedure listed on pages 12 and 13.

## COOKING INSTRUCTIONS - HIGH YIELD Preliminary Set-up

1. Adjust shelving appropriate for product being cooked. Make sure you have at least 2" (51mm) space between top of food product and shelf above.
2. Fill unit evaporator with 2.5 to 3 gallons (9.5 to 11.8L) of water. **Note:** the oven will preheat faster if hot water is used. Don't use water that is hotter than the desired doneness temperature.
3. Flip Power Switch to ON position. The display flashes **P r e h t** (preheat), indicating that the unit is warming up to current temperature setting.

4. To program DONENESS temperature, press DONENESS buttons to set desired temperature. Temperature range is 90° to 200°F (32° to 93°C).
5. To program degree of browning, press BROWNING buttons. Browning levels range from 0 to 10.

Browning Scale											
Time	0	1	2	3	4	5	6	7	8	9	10
	0°F	5°F	10°F	20°F	30°F	40°F	50°F	75°F	100°F	125°F	350°F Doneness Temp

Brown scale temperature equivalents are as follows:  
0=0, 1=5, 2=10, 3=20, 4=30, 5=40, 6=50, 7=75, 8=100, 9=125, 10= makes oven equal to 350°F (177°C) temperature.  
Example: 130°+10 (220) =350°, 150°+10 (200) =350°, 200°+10 (150) =350°, 180°+10 (170) =350°.





6. To program COOK TIME, press TIME buttons to customize cook cycle. Refer to guidelines found on page 14 for details.

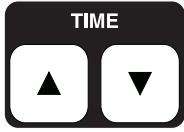

7. After programming DONENESS, BROWNING, and TIME, unit will heat to new setpoint. When setpoint has been reached, L o A d will appear on LED. This indicates that the unit is pre-heated and ready to be loaded with product.

8. Place food product on pan(s) (bun pans or steam table/hotel pans), making sure that spacing between product (vertically and horizontally) is at least 2" (51mm). Place pan(s) on the rack supports at about the middle of the oven.

9. Close door. Press START/STOP button to begin cook cycle.



10. The CVap® Cook & Hold Oven begins its timed countdown. The display shows the remaining cook time.

8. As timer counts down to zero, if the doneness temperature is less than 158°F, (70°C) timer will display alternately H o l d and the remaining FDA-recommended hold time (see the HOLD Cycle section on page 8).

9. S e l l display indicates that any FDA-recommended holding period has been completed, and that the food may be served. Timer indicates how long product has been in Sell Cycle.

### COOKING INSTRUCTIONS - CONSTANT COOK

1. Fill unit evaporator with 2.5 to 3 gallons (9.5 to 11.8L) of water. **Note:** the oven will preheat faster if hot water is used. Don't use water that is hotter than the desired doneness temperature. Adjust shelves if needed.

2. Flip Power Switch to the ON position.

3. Press CONSTANT Cook & Hold button.



4. To program DONENESS temperature, press DONENESS buttons to set desired endpoint temperature. Temperature range is 90° to 200°F (32° to 93°C).



5. To program BROWNING, press BROWNING buttons. Browning levels range from 0 to 10. See page 11 for detailed description of Browning levels.



6. To program COOK TIME, press TIME buttons to customize cook cycle.

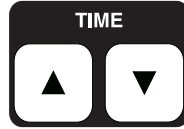

7. After programming DONENESS, BROWNING, and TIME, unit will heat to new setpoint. When setpoint has been reached, L o A d will appear on LED. This indicates that the unit is pre-heated and ready to be loaded with product.

8. Place food product on pan(s) (bun pans or steam table/hotel pans), making sure that spacing between product (vertically and horizontally) is at least 2" (51mm). Place pan(s) on the rack supports at about the middle of the oven.

9. Close door. Press START/STOP button to begin cook cycle.



10. The CVap® Cook & Hold Oven unit begins its timed countdown. The display shows the remaining cook time.

11. As timer counts down to zero, if the doneness temperature is less than 158°F (79°C), timer will display alternately S E L L and the remaining FDA hold time.

12. S e l l display indicates that any FDA-recommended holding period has been completed, and that the food may be served. Timer indicates how long product has been in Sell Cycle.

**NOTE:** When power switch is turned off, the controller remembers the last temperature and time values set.



HIDDEN KEYS

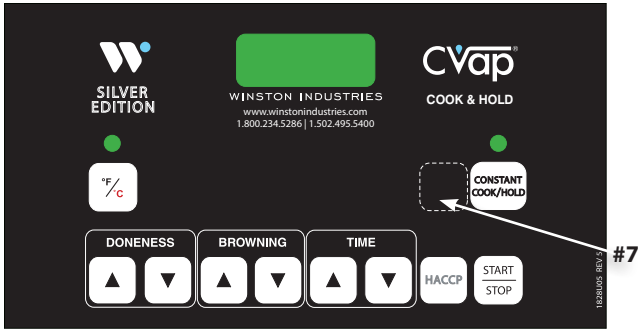

The “hidden” key (shown above) on the control panel allows additional programming functions. The keys are intended for management use only.

**#7 KEY - Adjust Sell/Hold temperature - 150°F (66°C), 155°F (68°C), 160°F (71°C), 165°F (74°C), 170°F (77°C), 175°F (79°C), 180°F (82°C):**

This key allows adjustment of the sell (long term holding) temperature. To operate this function, press and hold the #7 key for two seconds. The current sell temperature will be displayed. Adjust the temperature setting by tapping the #7 key. The value will be stored after two seconds of inactivity. Hold range will increase by five-degree increments.

**ELEc on LED**

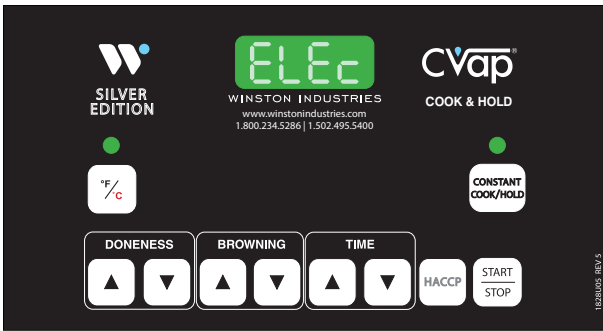

If the LED displays ELEc, it indicates that the unit has experienced an interruption in the power supply at some point during the cook cycle. This can be caused by a power failure, an electrical surge, by the power switch being turned off during a cook or hold cycle, or by the unit being unplugged. The LED will flash between ELEc and an advancing timer. Timer indicates how long it has been since power was restored to the unit.

To cancel this mode, push and hold the Start/Stop button for two seconds. This clears the memory so that a new cook cycle may be programmed.



PROGRAMMING FILL ALERT IN THE COOK & HOLD CONTROLLER

With power switch in the OFF position, press and hold both DONENESS arrow keys while switching power on.



Release the arrow keys after the current setting is displayed (FILL or noFL). Use the arrow keys to change the setting. This enables / disables the visual and audible alert for low water. The system will control water level regardless of the alert setting.

**FILL on LED**

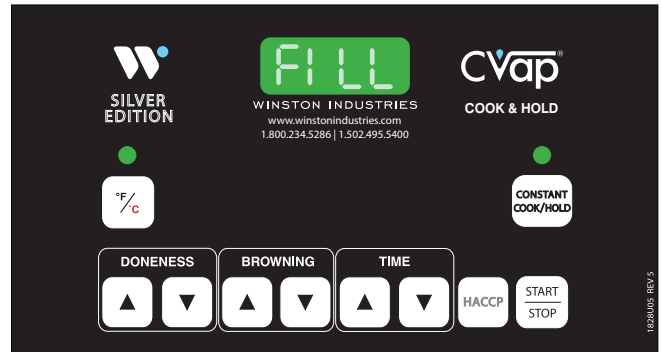

**noFL on LED**



**COOK & HOLD COOKING GUIDELINES**

When roasting meats or other large proteins, begin with a browning level of 5. This will produce moderate browning or texture. If less browning or texture is desired, select a browning level of 2-4. If more browning or texture is desired, select a browning level of 6-10.

**High Yield Cook:** Gives you the maximum possible yield for your foods. Once you have programmed the desired doneness temperature and browning level, the microprocessor automatically determines the best heat curve to give the highest yield possible.

**Constant Cook:** Allows the manual override of High Yield Cook Cycle, while automatically determining optimal holding temperatures for personalized cooking and holding.

**ON:** High Yield Cook Cycle is not functional. Constant cook light will illuminate to indicate that the Constant Cook Cycle has been activated.

**OFF:** High Yield Cook Cycle is functional.

**Slow Roasting/Roasting:** Cooking food in an uncovered pan, a method that will produce a browned or textured exterior while maintaining a moist, juicy interior. This roasting process can be utilized for either tender or tough pieces of meat. The moist environment within the CVap Cook & Hold Oven will tenderize cuts that are usually associated with braising.

**Braise:** Cooking in a small amount of liquid. The amount of liquid involved can vary. Some recipes call for foods to be half-immersed in liquid. Other recipes call for very little liquid. Braising can be a rapid process by which

foods are gently simmered (short braising), just until they're cooked through. Braising can also involve long, slow cooking (long braising). Foods may be browned before adding the liquid.

When braising, bring liquid to a simmer on stove top before placing into Cook & Hold Oven. This will help expedite the cooking cycle by one to two hours. Pans do not need to be foil-covered when cooking. Four-inch (102mm) braising pans are recommended. Once braising cycle is complete, product will be held at 150°F (66°C) during recommended hold cycle.

**Confit:** Food product is salted and slowly cooked in its own fat or any other type of fat, such as oil. Bring fat or oil to a simmer on stove top before placing into oven. Four-inch (102mm) braising pans are recommended. Once confit cycle is complete, product will be held at 150°F (66°C) during recommended hold cycle.

**Poach:** Food is gently cooked, completely submerged, in slightly simmering liquid just below boiling point.

**Steam:** Food is cooked gently in moist CVap environment, with temperature range of 200° - 230°F (93° - 110°C).

**Thermalizing:** Rapidly elevating food product temperature from thawed or frozen state to minimum temperature of 165°F (74°C).

**Baking:** When utilizing a CVap Cook & Hold Oven to bake items that normally require water during baking process, water baths are not needed. Place pans or ramekins directly on sheet pans or oven racks.

DAILY CLEANING

Required Cleaning Accessories and Supplies

- Pan for draining evaporator (unless utilizing floor drain)
- Food grade germicidal detergent
- Descaling agent

**! DANGER: Electrical Hazard**

Can cause serious injury or death >> If an electrical shock is felt during operation or cleaning, unplug equipment and have it serviced by a licensed electrician or trained servicer before placing back into service.

**! WARNING: Contamination Hazard**

Can cause serious illness or damage to equipment >> Clean equipment daily to avoid potential contamination hazard.

**Ensure safe operation by cleaning oven daily. Failure to do so can allow harmful deposits to develop, increasing the potential for food contamination, and endangering your customers.**

**! CAUTION: Corrosion Hazard**

Can cause damage to equipment >> Clean equipment daily to avoid potential corrosion damage.

Clean evaporator daily to prevent chlorides (salts) from accumulating. Chlorides can cause the evaporator tank to corrode, to the extent that leaks can occur. Leaks caused by corrosion, which is caused by a failure to clean daily, are not covered under the manufacturer's warranty.

**! WARNING: Contamination Hazard**

Can cause serious illness >> Clean equipment prior to first use to remove traces of industrial chemicals and oils.

Prior to using equipment for the first time, perform the daily cleaning procedure listed at right.

**! CAUTION: Burn Hazard**

Can cause injury >> Allow 30 minutes for equipment to cool before attempting to clean.

Before each cleaning procedure, disconnect equipment from its electrical power source and allow to cool for at least 30 minutes.

1. Place empty pan under drain valve, open valve, and allow evaporator to drain.
2. Remove and clean rack supports using a food grade germicidal agent.
3. Spray food chamber and evaporator with a food grade germicidal detergent.
4. Wipe inside surfaces to remove all food deposits.
5. Inspect for scale build-up on tank surface, float, and probe. (see photo below). If present, apply descaling agent. Read ALL warnings and follow directions listed on descaling agent package.

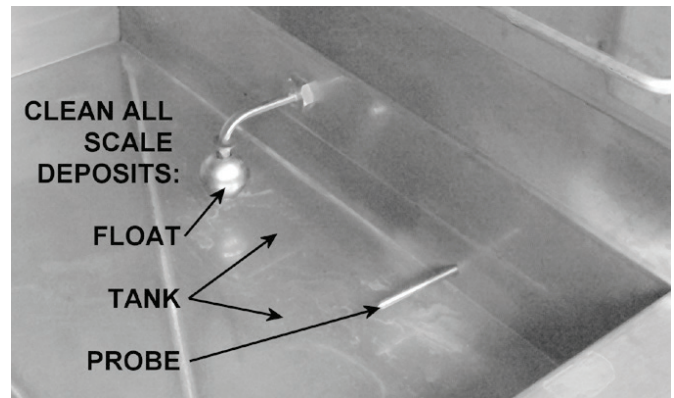

6. Inspect heating elements (if exposed). The heating elements are stainless steel. If cleaning is needed, scrub with a Teflon™ or nylon bristle brush to remove heavy food particles. Further cleaning may be done with a plastic scouring pad and alkaline based cleansers. **DO NOT** use wire brushes, scrapers, steel wool pads or chloride based cleansers. Follow cleanser manufacturer's instructions for use on stainless steel. Rinse well several times with clean water and wipe immediately.

7. Rinse all inside surfaces, including evaporator, and dry with clean towel.  
**Do not spray outside of equipment or controls with water.**

---

 **WARNING: Electrical Hazard**

Can cause serious personal injury or damage to equipment >> Avoid spraying equipment exterior or controls with water.

---

9. Verify that valve is closed, and refill evaporator.
10. Reconnect equipment to electrical power and make ready for use.

## WARRANTY AND TERMS & CONDITIONS

Limited 1 year Warranty (excluding gaskets, lamps, hoses, power cords, glass panels, fryer baskets, batteries, and evaporators). Warranty disclaimer for failure to clean.

WINSTON EXPRESSLY DISCLAIMS ALL OTHER WARRANTIES, EITHER EXPRESS OR IMPLIED, INCLUDING ANY IMPLIED WARRANTY OF FITNESS FOR A PARTICULAR PURPOSE AND ANY IMPLIED WARRANTY OF MERCHANTABILITY.

Ask us for a complete warranty disclosure or go to:

[www.winstonind.com/Documents/4272V089\\_zap\\_warranty\\_agreement.pdf](http://www.winstonind.com/Documents/4272V089_zap_warranty_agreement.pdf).

Terms and Conditions of Sale for Winston Foodservice' products are available here:

[www.winstonind.com/Documents/4272X833\\_terms\\_and\\_conditions\\_of\\_sale.pdf](http://www.winstonind.com/Documents/4272X833_terms_and_conditions_of_sale.pdf).

Both the Warranty and Terms and Conditions of Sale are integral to this document.

### Buy Winston Parts Online!

Parts and accessories for our products are available to purchase through our online, secure site – it's your one-stop shop for genuine Winston replacement parts. These parts are designed specifically for our products and can help you save on costly repairs while maintaining valuable warranty coverage.

[www.winstonind.com/buyparts/](http://www.winstonind.com/buyparts/).



Winston Foodservice is a Division of Winston Industries LLC

2345 Carton Drive | Louisville, KY 40299

800.234.5286 | +1.502.495.5400 | Fax +1.502.495.5458 | [www.winstonfoodservice.com](http://www.winstonfoodservice.com)