



HANDLING AND STORAGE

SERVING THE FOOD INDUSTRY SINCE 1951

EQUIPMENT STANDS

**Items 24185, 24087, 22056, 22057, 22058,
22059, 22060, 22061, 22062, 37961**



Omcan's equipment stands feature a durable 18-gauge type 430 stainless steel construction with galvanized legs and galvanized undershelf that can hold a capacity of 350-500 lbs.



WARRANTY



SHIPPED ON PALLET

Only applicable to items 22061 and 22062 only



Authorized Dealer



Equipment
Stand



Item 37961
Meat Grinder
Table

FEATURES

- 430 Stainless steel construction
- 18-gauge type
- Galvanized legs
- Galvanized undershelf
- Adjustable feet
- Table height is 24"
- Lip size is 1 1/2"

ITEM	DESCRIPTION (D x W)	LOADING CAPACITY	WEIGHT	UNDERSHELF CAPACITY	PACKAGING WEIGHT	PACKAGING DIMENSIONS
24185	30" x 12" 762 x 304.8 mm	500 lbs. / 227 kg.	31 lbs. / 14 kg.	350 lbs. / 159 kg.	34 lbs. / 15.45 kg.	32" x 14" x 7" 812.8 x 355.6 x 177.8 mm
24087	30" x 15" 762 x 381 mm	500 lbs. / 227 kg.	34 lbs. / 15.45 kg.	350 lbs. / 159 kg.	37 lbs. / 16.82 kg.	32" x 17" x 7" 812.8 x 431.8 x 177.8 mm
22056	30" x 18" 762 x 457.2 mm	600 lbs. / 272.73 kg.	36 lbs. / 16.36 kg.	400 lbs. / 181.82 kg.	39 lbs. / 17.73 kg.	32" x 20" x 7" 812.8 x 508 x 177.8 mm
22057	30" x 24" 762 x 609.6 mm	700 lbs. / 318.18 kg.	40 lbs. / 18.18 kg.	450 lbs. / 204.55 kg.	43 lbs. / 19.55 kg.	32" x 26" x 7" 812.8 x 660.4 x 177.8 mm
22058	30" x 30" 762 x 762 mm	800 lbs. / 363.64 kg.	47 lbs. / 21.36 kg.	450 lbs. / 204.55 kg.	50 lbs. / 22.73 kg.	32" x 32" x 7" 812.8 x 812.8 x 177.8 mm
22059	30" x 36" 762 x 914.4 mm	900 lbs. / 409.09 kg.	51 lbs. / 23.18 kg.	450 lbs. / 204.55 kg.	54 lbs. / 24.55 kg.	32" x 38" x 7" 812.8 x 965.2 x 177.8 mm
22060	30" x 48" 762 x 1219.2 mm	1100 lbs. / 500 kg.	62 lbs. / 28.18 kg.	500 lbs. / 227.27 kg.	65 lbs. / 29.55 kg.	32" x 50" x 7" 812.8 x 1270 x 177.8 mm
*22061	30" x 60" 762 x 1524 mm	1200 lbs. / 545.45 kg.	75 lbs. / 34.09 kg.	500 lbs. / 227.27 kg.	78 lbs. / 35.45 kg.	32" x 65" x 7" 812.8 x 1651 x 177.8 mm
*22062	30" x 72" 762 x 1828.8 mm	1300 lbs. / 590.91 kg.	84 lbs. / 38.18 kg.	500 lbs. / 227.27 kg.	87 lbs. / 39.55 kg.	32" x 74" x 7" 812.8 x 1879.6 x 177.8 mm
37961	31" x 31" with 15" backsplash	800 lbs. / 363 kg.	47 lbs. / 21.3 kg.	450 lbs. / 204 kg.	50 lbs. / 22.7 kg.	32" x 32" x 7" 812.8 x 812.8 x 177.8 mm



Item 24185

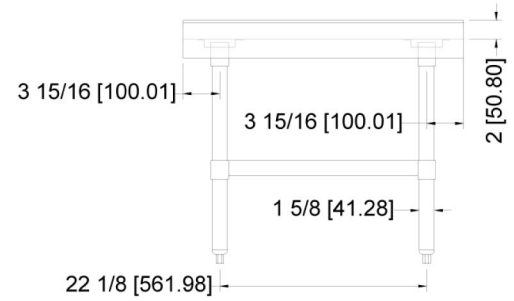
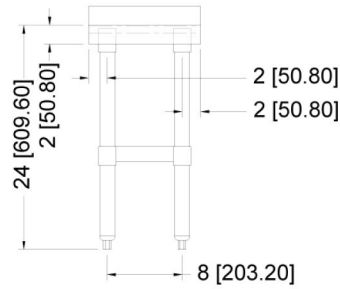
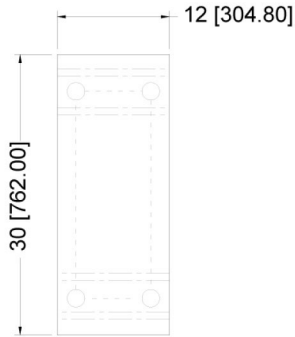

Item 24087

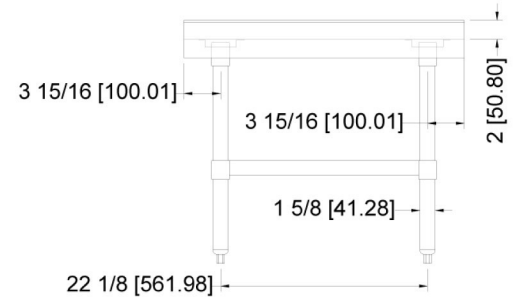
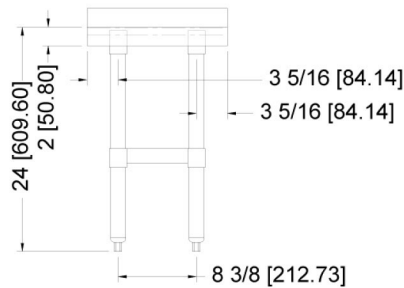
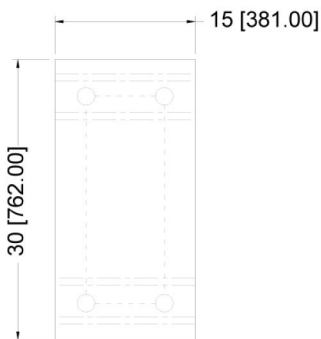

Item 22056

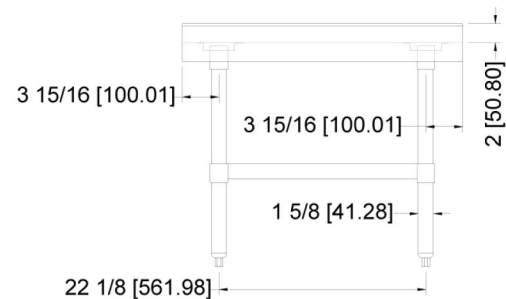
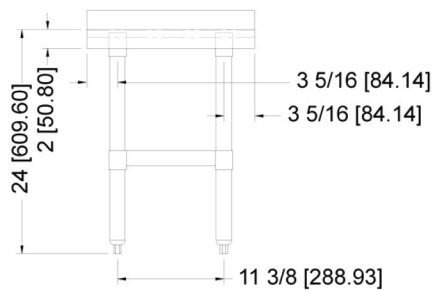
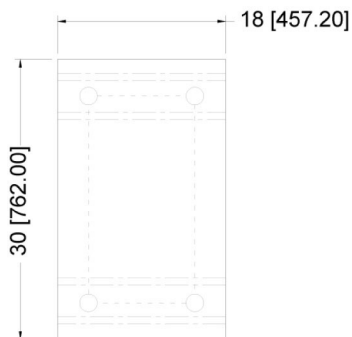

Item 22057

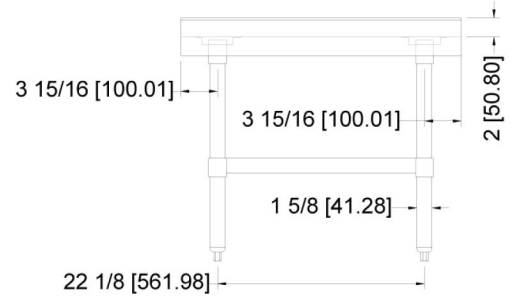
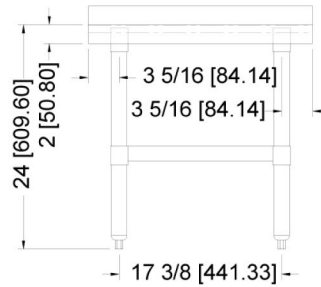
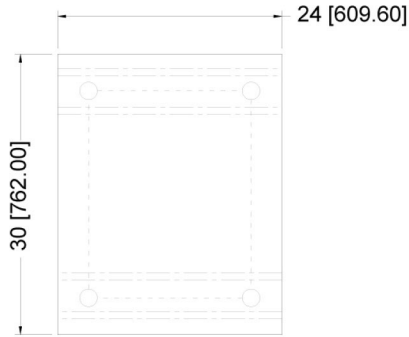

Item 22058

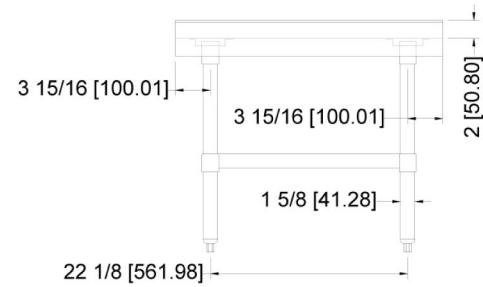
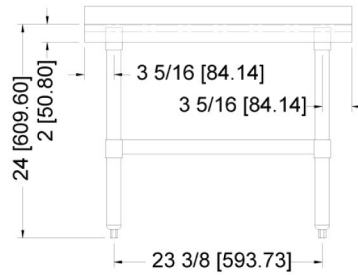
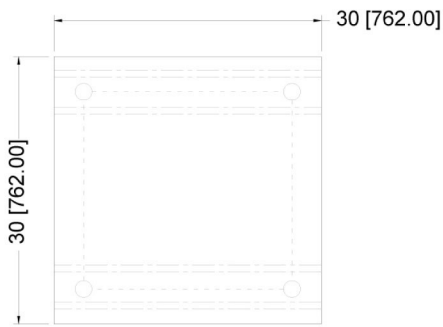

Item 22059

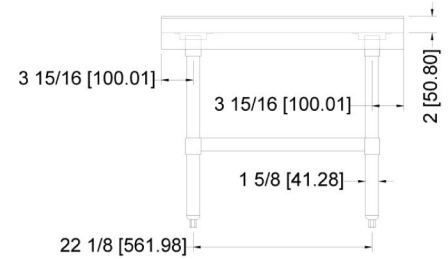
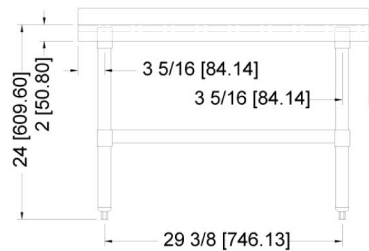
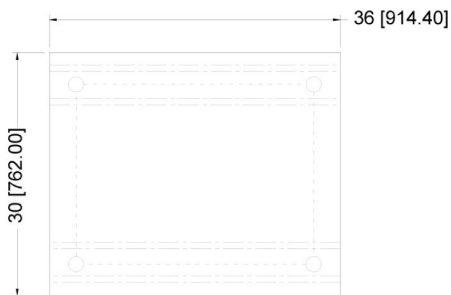

Item 22060

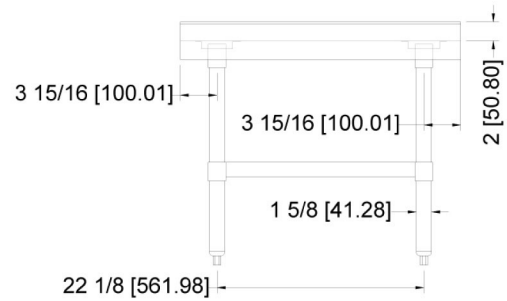
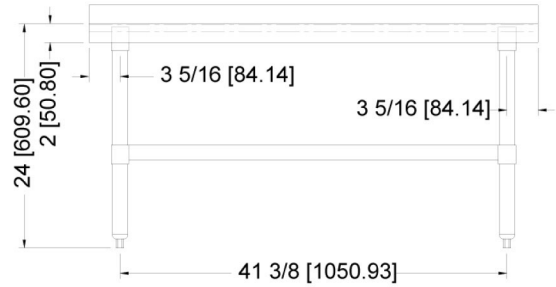

Item 22061

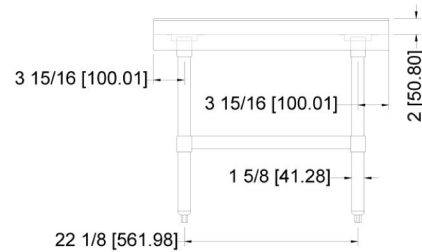
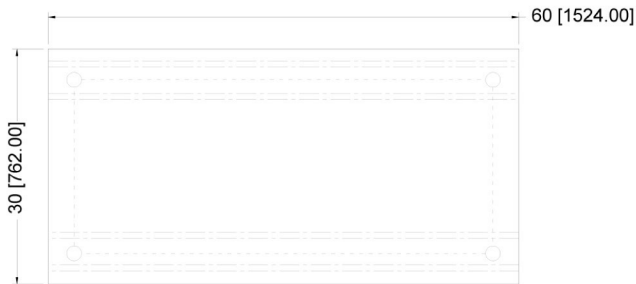

Item 22062

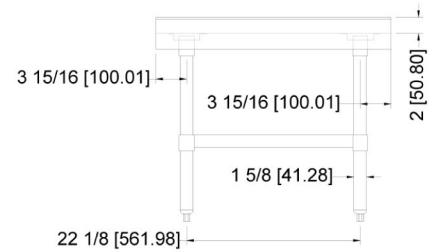

Item 37961

