

MODELS:

MBF8505GR / MBF8507GR / MBF8508GR

Bottom Mount Reach-In Refrigerator

Standard Features

- Bottom mount compressor units with environmentally friendly R290 refrigerant
- Stainless Steel Exterior & Interior
- Dixell digital controller
- Maintains temperatures between 33°F – 40°F
- LED interior light (s)
- Recessed door handle(s)
- Door locks(s) standard
- Magnetic door gaskets(s) standard for positive door seal
- Pre-installed castors
- Three (3) Pre-installed shelves per section
- Down Duct Refrigeration to Ensure even distribution of air.

Optional Features:

- Extra Shelves – includes 4 shelf clips per shelf
- 3" Casters



MBF8505GR



MBF8507GR



MBF8508GR

For the best results of food preservation we recommend setting your refrigerator between 33 °F - 38 °F

1. Don't forget to leave the unit some room to breathe!
2. Please clean the condenser frequently to give the unit more fresh air.



2 YEAR PARTS AND LABOR WARRANTY (US ONLY)
5 YEAR COMPRESSOR PART WARRANTY (US ONLY)



SPECIFICATIONS

Model	Doors	Cu. Ft	Shelves	Exterior Dimensions (WxDxH)	Castors	Weight (lbs.)	HP	Voltage	Amps	Refrigerant
MBF8505GR	1	19.1	3	27 × 31 ^{1/2} × 83 ^{1/8}	4 inch	282 lbs	1/7	115/60/1	2.1	R290
MBF8507GR	2	46.77	6	54 ^{3/8} × 31 ^{1/2} × 83 ^{1/8}	4 inch	452 lbs	1/5	115/60/1	3.2	R290
MBF8508GR	3	67.99	9	81 ^{7/8} × 31 ^{1/2} × 83 ^{1/8}	4 inch	615 lbs	1/4	115/60/1	4.2	R290

PLAN VIEW

MBF505GR

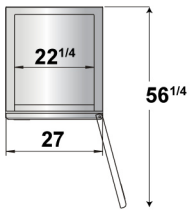

MBF507GR

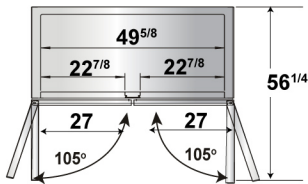

MBF508GR

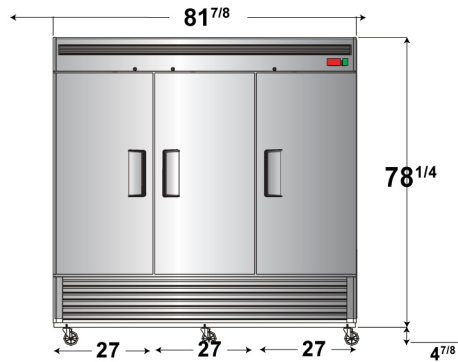
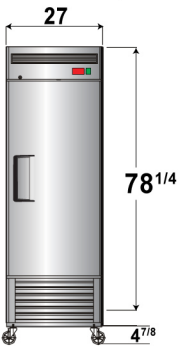
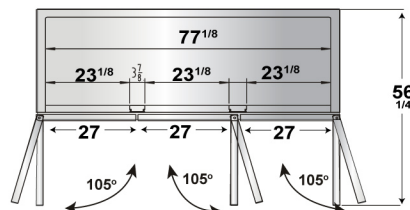

Side View

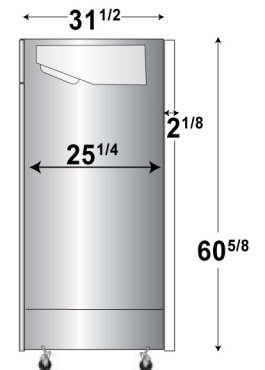

Castors



Epoxy Shelves



Door Lock



Down Duct



Temperature Control



NEMA 5-15P

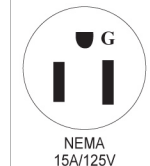

2 YEAR PARTS AND LABOR WARRANTY (US ONLY)
5 YEAR COMPRESSOR PART WARRANTY (US ONLY)

