

# 1100 Series Impinger® II Conveyorized Oven

## Models

- |                                     |                                     |                                     |                                     |                                     |
|-------------------------------------|-------------------------------------|-------------------------------------|-------------------------------------|-------------------------------------|
| <input type="checkbox"/> 1116-xxx-U | <input type="checkbox"/> 1131-xxx-U | <input type="checkbox"/> 1134-xxx-N | <input type="checkbox"/> 1155-xxx-E | <input type="checkbox"/> 1164-xxx-E |
| <input type="checkbox"/> 1117-xxx-U | <input type="checkbox"/> 1132-xxx-U | <input type="checkbox"/> 1151-xxx-N | <input type="checkbox"/> 1157-xxx-N |                                     |
| <input type="checkbox"/> 1130-xxx-U | <input type="checkbox"/> 1133-xxx-U | <input type="checkbox"/> 1154-xxx-E | <input type="checkbox"/> 1158-xxx-N |                                     |



## Benefits

- Faster bake times improve time of service.
- Advanced air impingement technology enhances bake quality and uniformity.
- Front removable conveyor for improved cleaning in tight spaces.
- Research and applications support for continued operational success.
- Manitowoc Star Service Support is committed to ongoing customer satisfaction.
- FastBake™ Technology designed to bake up to 35% faster than other conveyor ovens without increased noise levels or loss of product quality! (Optional)

## Standard Features:

- Customer specific finger setups provide menu flexibility
- Stackable up to three (3) high.
- 18" (457 mm) wide, 56" (1422 mm) long conveyor belt with product stop
- 28" (711 mm) baking chamber
- Temperature adjustable from 250°F to 575°F (121-302°C).
- Conveyor speed is adjustable from one (1) minute to thirty (30) minutes cooking time
- Stainless steel top, front and sides.
- Oven start-up/check-out by Manitowoc STAR authorized service agent included in price
- Digital controls
- Front-loading glass access door with cool to the touch handle
- Front removable conveyor for easy cleaning
- Reversible conveyor

## Specifications

Lincoln *Impinger* Conveyor Ovens are the premier continuous cook platform for the food service industry. Using the latest advancements in air impingement technology, *Impinger* ovens allow for rapid heating, cooking, baking, and crisping of foods, typically done two to four times faster than conventional ovens.

### Easy to Operate:

- Digital controls with single on/off power switch.
- Microprocessor controlled bake time/conveyor speed.

### Easy to Clean:

- Improved view vacuum florescent readout displays set temperatures in degrees (F° or C°), conveyor belt speed, thermostat indicator light, and diagnostic messages for easy trouble shooting.
- All settings are automatically locked out to eliminate accidental changes.
- Front loading conveyor and removable door make it the easiest oven to clean in the industry.

### Optional Features:

- *FastBake*: Improve your bake time by up to 35% without increased noise levels or loss of product quality!
- Entry and exit shelves.
- Flexible gas connector.
- Split belt



## Gas Supply Pressure Recommendations

Gas Type	Supply (Inlet) Pressure (mbar)	Recommended Minimum Gas Pipe Size
Natural	7-12" WC (1.7 kPa / 17.4 mbar - 2.9 kPa / 29.9 mbar)	1½" (38 mm)
LP	11-12" WC (2.7 kPa / 27.36 mbar - 2.9 kPa / 29.9 mbar)	1½" (38 mm)

\*Gas supply pressures are dependent on local gas type and on all applicable local codes. Agency approved flexible connection to each oven must be minimum ¾" (19 mm) NPT and length must not exceed six (6) feet (1829 mm).

## Electrical Service

Each oven deck requires voltage, phase and hertz as indicated by model number. Neutral must be grounded at electrical service and receptacle properly polarized. Gas 120V units have a cord with NEMA 5-15 plug. All other models have terminal block connections. It is recommended that a separate circuit breaker be provided for each oven deck.

## Recommended Minimum Clearances

Rear of oven to Combustible Surface: 6" (152mm). Additional clearance on right hand side from other cooking equipment: 24" (610mm). The conveyor is removable from the front.

## Warranty

All new *Impinger* ovens installed in the United States and Canada come with a one (1) year parts and labor warranty starting from the date of start-up/check-out. All ovens installed in locations other than in the US and Canada are warranted for one (1) year parts and ninety (90) days labor starting from the date of start-up/check-out. Start-up must occur within 24 months of date of manufacture.

## General Information

All 1100 Models	Length	Depth	Height Single	Height Double Stacked	Height Triple Stacked
	56" (1422 mm)	39" (991 mm)	42" (1067 mm)	59½" (1511 mm)	62" (1575 mm)

Model Number	Agency	Utility	Input Rate	Voltage	Amps	Hertz	Phase	Supply Wires
1116-xxx-U	UL EPH/CSA	Natural	40,000 BTU/Hr. 11.7 kW/42.2 MJ	120	7	60	1	3, 1 Pole+N+G
1154-xxx-E	AGA/UL EPH/CE	Natural		230	2	50	1	3, 1 Pole+N+G
1157-xxx-N	UL EPH	Natural		220		60	1	3
1117-xxx-U	UL EPH/CSA	LP		120	7	60	1	3, 1 Pole+N+G
1155-xxx-E	AGA/UL EPH/CE	LP		230	2	50	1	3, 1 Pole+N+G
1158-xxx-N	UL EPH	LP		220		60	1	3
1130-xxx-U	UL EPH/UL/cUL	Electric	10 kW	120/208	48	60	1	4, 2 Pole+N+G
1131-xxx-U	UL EPH/UL/cUL	Electric		120/240	42	60	1	4, 2 Pole+N+G
1132-xxx-U	UL EPH/UL/cUL	Electric		208	28	60	3	4, 3 Pole+N+G
1133-xxx-U	UL EPH/UL/cUL	Electric		240	25	60	3	4, 3 Pole+N+G
1134-xxx-N	UL EPH	Electric		380/208		50	3	5
1151-xxx-N	UL EPH	Electric		200	29	50/60	3	4, 3 Pole+N+G
1164-xxx-E	CE/UL EPH	Electric		400/230	42	50	3	5, 3 Pole+N+G

NOTE: Panel setups are added as kit numbers to the end of the model number to complete the oven order (Ex. 1116-000-U-K1837 is a 1116-000-U with Standard setup, Left to Right)

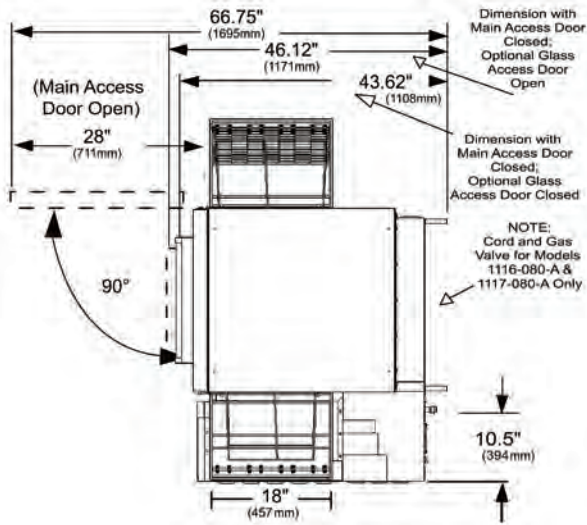

Conveyor Opening: 3" (76.2 mm)

Optional Split Belt (50/50):

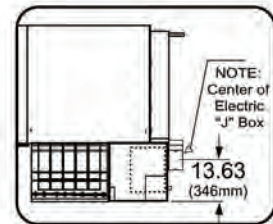
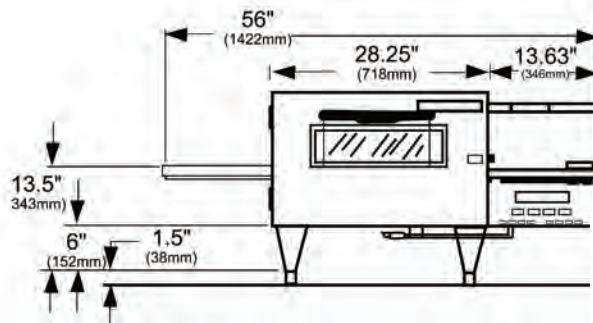
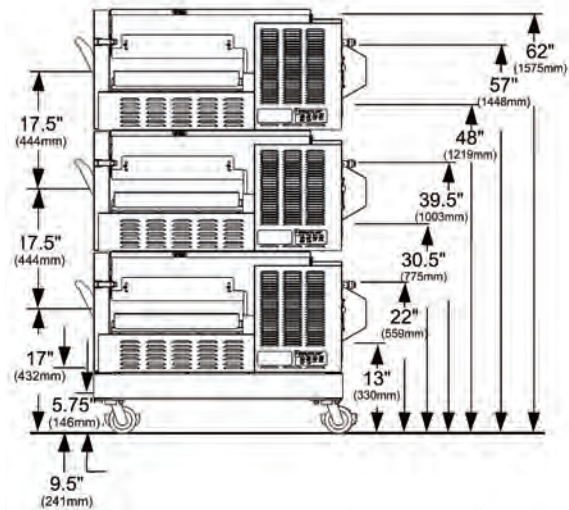
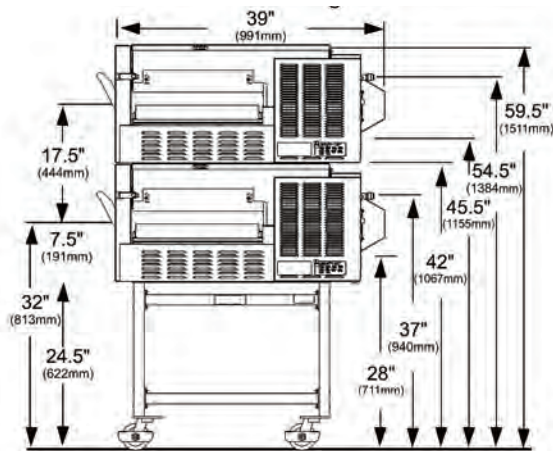
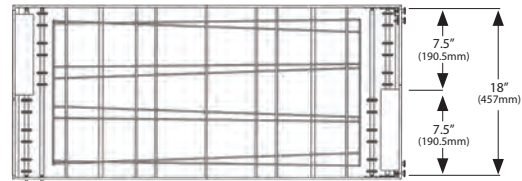

Electric Models

NOTE: Specifications subject to change without notification.

## Capacity Estimates | Pies Per Hour

Pie Size	BAKE TIME								
	3 min.	3½ min.	4 min.	4½ min.	5 min.	5½ min.	6 min.	6½ min.	7 min.
12" (30 cm)	53	46	40	35	32	29	26	25	23
14" (36 cm)	41	35	31	27	25	23	21	19	18
16" (41 cm)	35	30	26	24	21	19	18	16	15

## Ventilation Requirements

Ventilation is required on all gas ovens. Ventilation is not required on electric models except when triple stacked. Local codes prevail. These are the "authority having jurisdiction" as stated by the National Fire Protection Association, Inc. in NFPA 96-1994. Estimates of CFM requirements can vary from 400 to as high as 2800 CFM exhaust. In all cases, the ambient temperature around the oven must not exceed 95°F (35°C) when the oven is operating. **In the case where a gas single or double stack oven is installed, the following information can be used as a guideline for ventilation.**

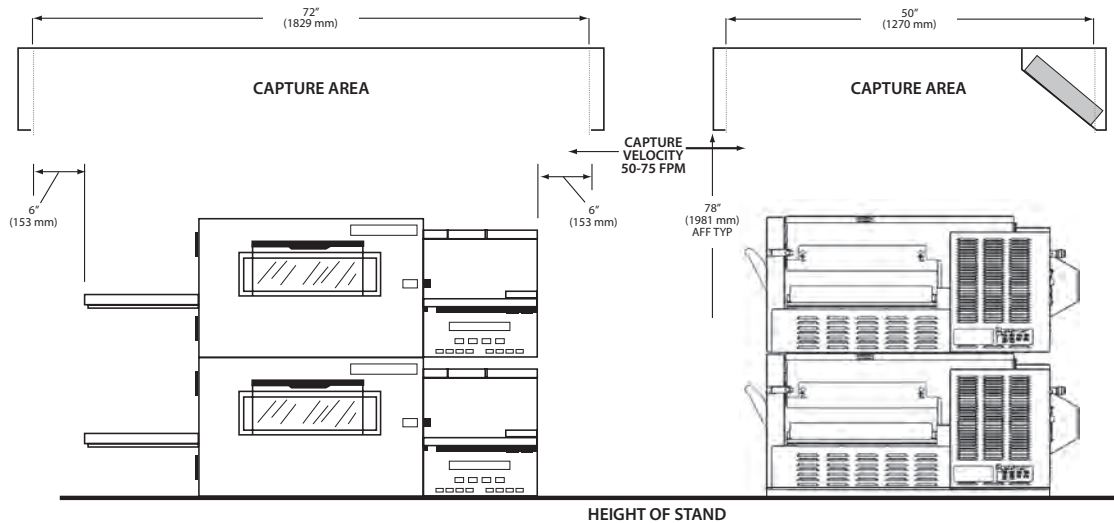

1. Double Stack: Range of 800-1200 cfm for double gas 1100 series oven.  
Single Stack: Range of 450-800 cfm for single gas 1100 series oven.
2. The capture velocity across the apron of canopy is to be 50-75 FPM at sides and front.
3. Double Stack: Width should be 72" (1828 mm) - inside dimensions. Depth should be 50" (1270 mm) - inside front to filters.  
Single Stack: Width should be 48" (1219 mm) - inside dimension. Depth should be 50" (1270 mm) - inside front to filters.
4. The ovens are to be centered in the canopy space left-to-right and front-to-back if possible.
5. Room air diffusers must not be directed onto the oven and should be positioned a minimum of 3 feet from the perimeter of the hood to keep them from affecting the oven.
6. Bottom of canopy should be 78" (1981 mm) above finished floor (AFF).
7. Recommend 70% make-up air provided outside of the canopy through perf metal diffusers directed straight down... not at the oven; located at front, sides or both.
8. Use of a Type I or Type II application and overall final installation is determined per local codes.

NOTE: Specifications subject to change without notification.