



Master Half-Size Electric Convection Oven

Item: _____
 Quantity: _____
 Project: _____
 Approval: _____
 Date: _____

Master Half-Size Electric Convection Oven

Models:

- MCO-E-5-C MCO-E-25-C



Model MCO-E-5-C

NOTE: Ovens supplied with casters must be installed with an approved restraining device.

Standard Features:

- Master 200 Solid State Control with 150° (66°C) to 500°F (260°C) temperature range
- 2-Speed 1/3 HP motor with thermal hi-limit and centrifugal switch protection
- 208 or 240 volt, single or three phase (please specify)
- Total of 5.6 kW elements per oven cavity
- Stainless steel front, sides, and top
- Single door with double pane thermal window
- 4" (102mm) stainless steel legs with adjustable bullet leveling leg insert.
- Porcelain enameled oven interior
- 5 chrome plated oven racks on 9-position rack guides
- Double deck models available -Suffix 25-C
- 1 year limited parts & labor warranty (USA & Canada only)
- 5 year limited door warranty, excluding window (USA & Canada only)

- 2 year limited parts & 1 year labor warranty (USA only)
- 2 year limited parts & labor warranty (USA Kindergarten to Grade 12 schools only)

Optional Features:

- 7.5 kW elements
- Extra oven racks
- Stainless steel main back
- Solid stainless steel door, (no charge)
- Stainless steel equipment stand 34" (864mm) high with rack guides. (only for single deck models only)
- 21 1/4" (540mm) stainless steel legs (double deck models only)
- Cord and plug set
- Swivel casters w/front brakes (single decks overall height 31 3/4" (806mm) double stacked units overall height 57" (1448mm) (Note: Casters can not be installed onto stands or stacked models with 21 1/4" legs.)

Specifications:

Garland Master Half-Size electric convection oven. 5.6 kW/ cavity, 1/3 HP fan motor with two-speed control. Porcelain enameled oven, 5 oven racks and 9-position rack guides, measures 15-1/2" (470mm)W x 20" (508mm)H x 21-1/8" (536mm)D. Stainless steel front, top, and sides. UL, CUL and NSF Listed.



Model #	Interior Dimensions (per deck)			Ship Wt. Lbs/Kg	Ship Cu Ft
	W	H	D		
MCO-E-5-C	15-1/2" (393mm)	20" (510mm)	21 1/8" (537mm)	340/155	38.5
MCO-E-25-C	15-1/2" (393mm)	20" (510mm)	21 1/8" (537mm)	680/310	77

Package	Total kW	Nominal Amperes Per Line							
		208V/1Ph	240V/1Ph	208V/3Ph			240V/3Ph		
				X	Y	Z	X	Y	Z
Standard	5.6	27	23	23	12	14	20	12	14
Option	7.5	39	33	23	21	22	20	18	19

Installation Notes:			
Combustible Wall Clearances			
Sides	*1" (25.4mm)	Back	1" (25.4mm)
<p>*Note: Installations beside units with high heat sources it is recommended to leave 6" (152mm) on the right side of oven. Refer to the installation manual for more detail</p>			
Entry Clearance			
Crated		Uncrated	
37" (940mm)		31" (787mm)	

NOTE: Double decks require 2 power supplies please specify electrical characteristics when ordering.

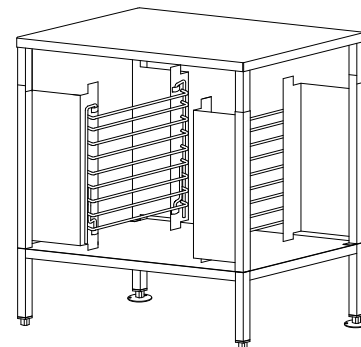
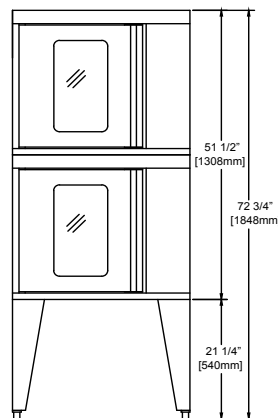
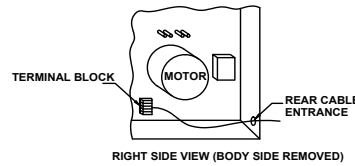
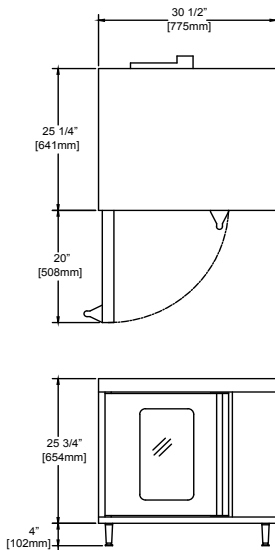

Optional equipment stand for single deck models. Stand is 34" (864mm) high.

Form# MCO-E-5/25-C (09/22/15)